



testo 230 · pH- and temperature measuring instrument

Instruction manual



1	Contents	3
1	Contents	3
2	Safety and the environment	5
2.1.	About this document	5
2.2.	Ensure safety	5
2.3.	Protecting the environment	6
3	Specifications	7
3.1.	Use	7
3.2.	Technical data	7
4	Product description	9
4.1.	Overview	9
4.1.1.	Control elements and connections	9
4.1.2.	Display	10
4.2.	Connection variants	11
5	First steps	13
5.1.	Commissioning	13
5.1.1.	Installing the sensor	13
5.1.2.	Switching the instrument on	13
5.2.	Calibrating the instrument	14
5.2.1.	Single-point calibration	14
5.2.2.	Two-point calibration	16
6	Using the product	18
6.1.	Performing settings	18
6.2.	Measuring	19
6.2.1.	pH-measurement	19
6.2.2.	Temperature measurement	20
6.2.3.	Redox measurement	20
6.2.4.	Hold function	20
6.2.5.	Auto-Hold function	21
7	Maintaining the product	22
7.1.	Replacing the battery	22
7.2.	Cleaning the instrument	22

8	Tips and assistance	23
	8.1. Questions and answers	23
	8.2. Accessories and spare parts	26
9	Appendix.....	27
	9.1. Electrode/application assignment	27
	9.2. Buffer table.....	30

2 Safety and the environment

2.1. About this document

Use

- > Please read this documentation through carefully and familiarize yourself with the product before putting it to use. Pay particular attention to the safety instructions and warning advice in order to prevent injuries and damage to the products.
- > Keep this document to hand so that you can refer to it when necessary.
- > Hand this documentation on to any subsequent users of the product.

2.2. Ensure safety

- Temperatures given on probes/sensors relate only to the measuring range of the sensors. Do not expose handles and feed lines to temperatures in excess of 70 °C (158 °F), unless they are expressly permitted for higher temperatures.
- Degree of protection IP 54 is only ensured with the sensor or blanking plug plugged in.
- Electrolytic solutions are corrosive; do not bring into contact with measuring instruments or other sensitive surfaces!
- Ether, ester, cetones as well as aromatic or halogenated hydrocarbons will attack the shaft material and must therefore not come in contact with the electrode.
- The electrode housing is partly made of glass,
CAUTION, DANGER OF BREAKAGE!
- > Only perform maintenance and repair work on this instrument that is described in the documentation. Strictly follow the specified steps. Use only original spare parts from Testo.
- > Do not store the product together with solvents. Do not use any desiccants.

- > Do not perform any contact measurements on uninsulated, live parts.
- > Dangers may also arise from objects to be measured or the measuring environment: Always comply with the locally valid safety regulations when performing measurements.
- > Only use the product properly, for the purpose it is intended for and within the parameters specified in the technical data. Do not apply any force.

2.3. Protecting the environment

- > Dispose of faulty rechargeable batteries/spent batteries in accordance with the valid legal specifications.
- > At the end of its useful life, send the product to the separate collection for electric and electronic devices (observe local regulations) or return the product to Testo for disposal.

3 Specifications

3.1. Use

The testo 230 serve the purpose of determining pH-values, redox potentials and temperature in aqueous solutions as well as in semi-solid to solid media.

3.2. Technical data

Instrument	
Feature	Values
Measurement range	pH 0...14, -50...+150 °C, ± 1999 mV
Resolution	pH 0.01, 0.1 °C (°F), 1 mV
Accuracy (± 1 digit)	± 0.01 pH ± 0.4 °C (-50...-25 °C) ± 0.2 °C (-25...+75 °C) ± 0.4 °C (+75...+100 °C) ± 0.5 % of mv (+100...+150 °C) ± 1 mV (0... ± 999 mV) ± 2 mV (± 999 ... ± 1999 mV)
Temperature compensation	man -10...+150 °C auto -50...+150 °C
Operating temperature	0...+40 °C
Storage/transport temperature	-20...+70 °C
Display	two-line
Connections	BNC compatible socket for pH or pH/°C resp. Mini-DIN socket for temperature sensor
Battery life	approx. 100 hrs.
Weight	180 g (incl. battery)

3 Specifications

Feature	Values
Degree of protection	IP 54 (only with plugged in original plug or blanking plug)
Housing material	ABS
Warranty	Terms of warranty see www.testo.com/warranty
Measuring instrument	24 months
Electrode	12 months
Sensor	12 months

Electrodes/temperature sensors

Feature	Values
pH universal plastic electrode without temperature sensor (0650 2063)	Measurement range: 0...14 pH Operating temperature: 0...+60 °C short-term up to +80 °C
pH universal plastic electrode with temperature sensor (0650 2064)	Measurement range: 0...14 pH Operating temperature: 0...+60 °C Temperature sensor: Pt 1000
pH glass electrode with temperature sensor (0650 1623)	Measurement range: 0...14 pH Operating temperature: -10...+80 °C Temperature sensor: Pt 1000
pH food electrode without temperature sensor (0650 0245)	Measurement range: 2...14 pH Operating temperature: 0...+40 °C
Rugged NTC penetration food sensor with special handle, reinforced PUR line (0613 2411)	Measurement range: -25...+150 °C t_{99} : 7 s
Stainless steel NTC food sensor (IP65) with PUR line (0613 2211)	Measurement range: -50...+150 °C. t_{99} : 8 s

4 Product description





4.1. Overview

4.1.1. Control elements and connections



1 Display see Display page 10

2 Keyboard

Key	Function
	Switching on/off
	To call up individual menu levels
	To hold readings or, with manual input function, set readings
	To select menu options or, with manual input function, set readings

- 3 Battery compartment (on rear)
- 4 BNC connecting socket for pH and redox electrode
- 5 Mini-DIN connecting socket for NTC temperature sensor

4.1.2. Display

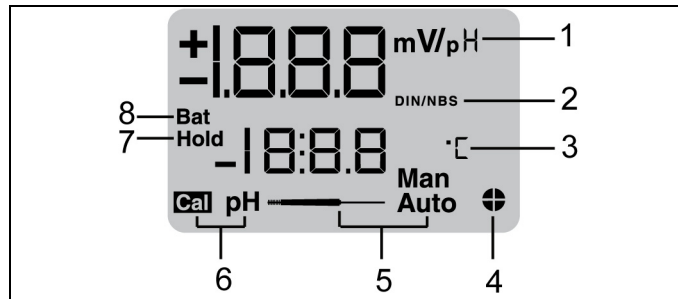





- 1 Reading (pH/mV, °C for temperature measurements without pH electrode)
- 2 DIN/NBS buffer (display in alignment menu)
- 3 Reading (°C for temperature measurements)
- 4 Auto-Off display: The circle segments in the display go out in a 2.5 minute interval. After the last segment (10 minutes) the instrument switches off. Switching off the function, see Switching Auto-Off on / off page 18.
- 5 Sensor detection

Icon	Function
Man	Electrode without temperature sensor
	External temperature sensor
+Auto	
Auto	Electrode with temperature sensor

- 6 Representation of alignment menu
- 7 Hold function / Auto-Hold function
- 8 Battery control:
 - When switching on Battery voltage
 - In operation: Warning of weak battery

4.2. Connection variants

Measurement	Probes	function	Display
pH / temperature measurement	pH-electrode with integrated temperature sensor (0650 1623, 0650 2064)	The pH-electrode is used to determine pH-value and temperature of the medium. During measurement and alignment the medium temperature is automatically included in the process.	
pH / temperature measurement	pH-electrode without integrated temperature sensor (0650 2063, 0650 0245) NTC-sensor with Mini-DIN connection	The pH-electrode is used to determine the pH-value, the medium temperature is measured with the NTC-sensor. During measurement and alignment the medium temperature is automatically included in the process.	
pH-measurement	pH-electrode without integrated temperature sensor (0650 2063, 0650 0245)	The pH-electrode is used to determine the pH-value of the medium. During measurement and calibration the medium temperature must be entered manually.	
Temperature measurement	NTC-sensor with Mini-DIN plug	With the NTC-sensor the testo 230 is a fully adequate temperature measuring instrument to cover the range from -50 °C ... +150 °C.	

4 Product description

Measurement	Probes	function	Display
Redox measurement	Redox electrode ¹	<p>The redox electrode is used to determine the redox potential of the medium.</p> <p>With the NTC-sensor the temperature can additionally be determined. However, the temperature has no influence on the redox measurement.</p>	

¹ no longer available

5 First steps

5.1. Commissioning

5.1.1. Installing the sensor

Before the instrument is switched on the electrode cable must be connected.



1. Plug the BNC-plug of the electrode into the socket and turn clockwise to lock.
2. Plug the external NTC-sensor with Mini-DIN plug or blanking plug into the socket.



IP-protection (IP 54) is only ensured with the NTC-sensor or blanking plug plugged in.

3. If desired: Fasten the electrode or the NTC-sensor with the holder on the instrument.

5.1.2. Switching the instrument on

- > press **I/O**.
- The display and function test appears in the display.
- The battery condition is displayed.
- The instrument is ready to use.

5.2. Calibrating the instrument

Before the first measurement the instrument must generally be calibrated (single-point or two-point).

For measurements in extreme solutions (pH-value < 1 and pH-value > 12), for frequent use and if very high accuracy is required, the unit should be calibrated before each measurement.

5.2.1. Single-point calibration

Single-point calibration serves the purpose of quickly adapting the instrument to the electrode.

The following buffers can be used for this purpose:

- Testo buffer pH 4, pH 7, pH 10
- DIN buffer pH 4.008²; pH 6.865²; pH 9.18



Also pay attention to the application information for the buffer used.

1. Connect the electrode to the instrument.

If a plug is present:

- > Open the plug on the electrode (to equalise pressure).
2. Pull the rinsing cap off the electrode.
 3. Rinse the electrode in water, dab off and place it into the buffer solution
 4. press **I/O**.
 5.  press several times, until **CAL** appears in the display.
 - **CAL** (status bar) flashes in the display.
 6. Press **SELECT** to confirm.
 - > If an electrode without temperature sensor and no external temperature sensor is used, enter the temperature manually via **HOLD** and **SELECT**.
 - Wait 5 seconds, the instrument accepts the set temperature.
 - The display shows **bu 1**.

² Display reading: DIN/NBS pH 4.01, pH 6.87

-
7. Press **HOLD** to select the buffer to be used (pH 1.68 DIN/NBS; 4.00; 4.008 DIN/NBS²; 6.865 DIN/NBS²; 7.00; 9.18 DIN/NBS; 10.00).
 - **pH** flashes in the display.
 8. Press **SELECT** to start the calibration process.
 - During the calibration process **CAL** is flashing (duration of calibration min. 20 sec., max 10 min.). An audible signal informs about the end of the calibration process.
-
- i** After max. 10 min. the calibration process is aborted, the electrode is most likely defective, in this case consult our service department. Contact data see back of this document or website www.testo.com/service-contact.
-
- The display shows **bu 2**. This menu option is needed for two-point calibration, see Two-point calibration page 16.
9. Press  to exit the menu.
 - The display shows the default gradient value **-58.0mV/pH**.
 10. Press **SELECT** to confirm.
 - The display shows the unbalancing voltage.
 11. Press **SELECT** to confirm.
 - Single-point calibration has been completed.
 - The instrument changes to the measurement mode. Measuring page 19.

5.2.2. Two-point calibration

Two-point calibration serves the purpose of accurately adapting the instrument to the electrode.

The following buffer sets can be used for calibration:

- Testo buffer set pH 4/7, pH 4/7/10
- DIN buffer set pH 4.008/6.685³, pH 6.865/9.18³

i Also pay attention to the application information for the buffer used.

i The difference between buffer solutions **bu 1** and **bu 2** must be higher than 0.64 pH.

1. Connect the electrode to the instrument.
If a plug is present:
 - > Open the plug on the electrode (to equalise pressure).
2. Pull the rinsing cap carefully off the electrode.
3. Rinse the electrode in water, dab off and place it into the first buffer solution
4. press **I/O**.
5.  press several times, until **CAL** appears in the display.
 - **CAL** (status bar) flashes in the display.
6. Press **SELECT** to confirm.
 - The temperature is displayed.
 - > If an electrode without temperature sensor and no external temperature sensor is used, enter the temperature manually via **HOLD** and **SELECT**.
 - Wait 5 seconds, the instrument accepts the set temperature.
 - The display shows **bu 1**.

³ Display reading: DIN/NBS pH 4.01, pH 6.87

-
7. Press **HOLD** to select the buffer to be used (pH 1.68 DIN/NBS; 4.00; 4.008 DIN/NBS³; 6.865 DIN/NBS³; 7.00; 9.18 DIN/NBS; 10.00).
 - **pH** flashes in the display.
 8. Press **SELECT** to start the calibration process.
 - During the calibration process **CAL** is flashing (duration of calibration min. 20 sec., max 10 min.). An audible signal informs about the end of the calibration process.

i After max. 10 min. the calibration process is aborted, the electrode is most likely defective, in this case consult our service department. Contact data see back of this document or website www.testo.com/service-contact.

- The display shows **bu 2**.
9. Rinse the electrode in water, dab off and place it into the second buffer solution
 10. Press **HOLD** to select the buffer to be used.
 11. Press **SELECT** to start the calibration process.
 - During the calibration process **CAL** is flashing (duration of calibration min. 20 sec., max. 10 min.). An audible signal informs about the end of the calibration process.

i After max. 10 min. the calibration process is aborted, the electrode is most likely defective, in this case consult our service department. Contact data see back of this document or website www.testo.com/service-contact.

- The display shows the gradient value.
12. Press **SELECT** to confirm.
 - The display shows the unbalancing voltage.
 13. Press **SELECT** to confirm.
 - Two-point calibration has been completed.
 - The instrument changes to the pH-measurement mode. Measuring page 19.

6 Using the product

6.1. Performing settings

testo 230 has a configuration menu in which the following successive settings can be made:

- 1 Change measuring unit from °C to °F and vice-versa.
- 2 Switch Auto-Off function on or off.
- 3 In Clear mode the values saved by an alignment can be overwritten, e.g. if the electrode needs to be changed and an alignment is not possible.

Changing the unit

- ✓ The instrument is switched off.
- 1. Keep **HOLD** depressed and tap **I/O** instantaneously.
- 2. Keep **HOLD** depressed, until the segment test is finished.
 - °C or °F flashes in the display.
- 3. Use **SELECT** to set the desired unit.
- 4. Press **HOLD** to confirm.
 - **Off** (Auto-Off) flashes in the display.

Switching Auto-Off on / off

i The Auto-Off function prolongs the lifetime of the battery and protects the environment. Always make sure that the instrument is switched off when the Auto-Off function is disabled.

5. Press **SELECT** to switch the Auto-Off on (**on**) or off (**off**).
6. Press **HOLD** to confirm.
 - The display shows **clr no** (flashing).

Performing a reset (Clear mode)

7. Press **SELECT** to select **yes**.
 - > If **no** is selected, the previous values will be maintained.
8. Press **HOLD** to acknowledge.
 - The previously valid values will be deleted and the ideal values (-58 mV/pH and 0 mV) will be saved in the instrument.
 - The instrument changes to the measurement mode.

6.2. Measuring

6.2.1. pH-measurement

- ✓ Single or two-point alignment has been made, see Calibrating the instrument page 14.

1. Connect the electrode to the instrument.

If a plug is present:

- > Open the plug on the electrode (to equalise pressure).
2. Pull the rinsing cap off the electrode.
 3. Rinse the electrode in water and dab off (see also operating instructions for pH-electrodes).
 4. Place the electrode into the measuring solution.
 5. press **I/O**.
 - The display shows pH-value (initially unstable) and temperature. If the display reading is stable, the measuring value is correct.

If an electrode without temperature sensor and no external temperature sensor is used, enter the temperature manually.

1. Press **SELECT**.
 - **MAN** flashes in the display.
2. Press **HOLD** and **SELECT** to correct the value upwards or downwards.
 - Wait 5 seconds, the instrument accepts the set temperature.

6.2.2. Temperature measurement

✓ NTC sensor connected.

1. Place the NTC sensor into the measuring solution.

2. Press **I/O**.

3.  Press three times.

- The temperature is displayed. If the display reading is stable, the measuring value is correct.

Back to the pH measurement menu:

> Press  two times.

6.2.3. Redox measurement

✓ Redox electrode connected.

1. Place the redox electrode into the measuring solution.

2. Press **I/O**.

3.  Press two times.

- The redox potential (initially unstable) is displayed. If the display reading is stable, the measuring value is correct.

Back to the pH measurement menu:

> Press  two times.

6.2.4. Hold function

With **HOLD** the reading can be held during a progressing measurement.

> Press **HOLD**.

- The display shows **Hold** besides the reading.

- The reading is held in the display as long as desired, the Auto-Off function is disabled.

Quit:

> Press **HOLD**.

- The current reading is shown.

6.2.5. Auto-Hold function

The Auto-Hold function monitors the setting time during a measurement. Once the reading is stable, this status is indicated both visually and audibly.

1. Start measuring process (see Measuring Seite 19).
2. Press  to select **Auto-Hold**.
 - **Hold** flashes in the display.
 - Once the reading is stable a signal will sound, the reading and **Hold** are permanently displayed. The measuring process is completed.
 - If the reading does not become stable within 10 minutes, the display will show **ERR 6** (see Questions and answers page 23).

Return to measuring mode:

- > Press **HOLD**.

7 Maintaining the product

7.1. Replacing the battery

i The battery voltage is displayed whenever the instrument is switched on. If the battery voltage is low, the message **BAT** will appear in the display when measuring.

i Do not damage the instrument seal.

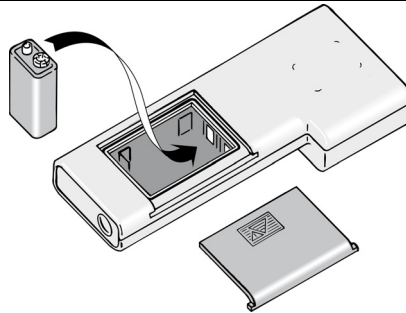

1. Open the battery compartment.
2. Replace the battery with a new battery of the same type (type 9 V IEC 6 F 22). Observe the polarity!
3. Close the battery compartment.

7.2. Cleaning the instrument





- > Clean the housing with a damp cloth. Mild household cleaning agents may be used.
- > Never use aggressive cleaning agents or solvents for cleaning.
- > The instrument is suitable for contact with weak acids and alkaline solutions. After use in aggressive environments the instrument must be cleaned with a damp cloth.

i For care and maintenance of the pH-electrodes you should read the operating instructions "testo pH-electrode".

8 Tips and assistance

8.1. Questions and answers

Question	Possible causes / solution
Err 1	<p>The pH reading is not in the range 0...14 pH.</p> <ul style="list-style-type: none"> • No pH-electrode connected. > Connect a pH-electrode. • Incorrectly calibrated. > Recalibrate. • pH-electrode defective. > Check the pH-electrode, replace if necessary. • Low pH-value when using electrode with high gradient and unbalancing voltage and, at the same time, high measuring temperature. > reduce the measuring temperature <p>The mV reading is not in the range of -1999...+1999 mV.</p> <ul style="list-style-type: none"> • No electrode connected. > Connect an electrode. • Redox electrode defective. > Check the electrode, replace if necessary.
Err 2	<ul style="list-style-type: none"> • Temperature range of the instrument exceeded. Temperature < -50 °C or > +150 °C. > Remove the sensor from the measuring medium.
Err 3	<ul style="list-style-type: none"> • Temperature range exceeded during calibration. Temperature of buffer solution outside permissible range. > Abort calibration by pressing  (the values of the last calibration are maintained). > Repeat the calibration with adapted temperature.

Question	Possible causes / solution
Err 4	<ul style="list-style-type: none"> • Gradient of electrode outside the range -50 mV/pH...-62 mV/pH, electrode defective. > Abort calibration by pressing  (the values of the last calibration are maintained). > Use a new electrode.
Err 5	<ul style="list-style-type: none"> • Neutral point of electrode outside the range -60...+60 mV, electrode defective. > Abort calibration by pressing  (the values of the last calibration are maintained). > Use a new electrode.
Err 6	<p>Electrode setting time too long (in Auto-Hold or when calibrating):</p> <ul style="list-style-type: none"> • Electrode dirty. • Electrode defective. > Delete error message by pressing  (abort calibration with , the values of the last calibration are maintained). > Rinse the electrodes and repeat the process. If the error occurs again, use a new electrode.
Err 7	<ul style="list-style-type: none"> • Internal instrument fault, measuring instrument defective. > Consult the Testo Customer Service or your dealer.

Question	Possible causes / solution
Unstable display	<ul style="list-style-type: none"> • Air bubbles in the glass bowl > Tap the electrode lightly with your fingers or perform circular movements with the electrode. • Air bubbles in the KCl-crystals > Tap the electrode lightly with your fingers or perform circular movements with the electrode. > Heat the electrode up in a 60 °C water bath, until a sufficient amount of KCl has been dissolved and the air bubbles have disappeared. • Poor connection > Check cable connection. • Sample solution with poor ionic strength (e.g. partly aqueous solution) > Use the electrode 0650 1623.
Low gradient and / or slow response	<ul style="list-style-type: none"> • Calibration fault caused by old buffers > Use fresh high quality buffers for calibration. • Glass membrane contaminated > Clean the glass ball with soft paper or a lens cleaning cloth and allow the electrode membrane to swell in pH 4.0 buffer. > Clean the electrode in tap water and rinse with distilled water. Then allow the electrode to swell for 30 minutes in buffer pH 4.0 while stirring and with the KCl filler opening open.
Drifting potential	<ul style="list-style-type: none"> • Contamination with oil or grease • Sulphide contamination of the porous pin > Clean the electrode with a water-miscible solvent (e.g. acetone), then rinse the electrode with warm, distilled water. • Allow the electrode to swell over a period of 24 hours in a solution of thiocarbamide in 0.1M HCl and finally rinse with distilled water.

If we have not answered your question, please contact your local dealer or Testo's Customer Service. Contact data see back of this document or website www.testo.com/service-contact.

8.2. Accessories and spare parts

Description	Article no.
<i>Electrodes and sensors</i>	
pH universal plastic electrode without temperature sensor, including storage/wetting cap	0650 2063
pH universal plastic electrode with temperature sensor, including storage/wetting cap	0650 2064
pH glass electrode with temperature sensor, including storage/wetting cap	0650 1623
pH food electrode without temperature sensor, including storage/wetting cap	0650 0245
Stainless steel NTC food sensor (IP65) with PUR line	0613 2211
Rugged NTC penetration food probe with special handle, reinforced PU line	0613 2411
<i>Other accessories</i>	
Electrolyte solution (50 ml) for storing pH electrodes in the storage/wetting cap	0554 2318
Replacement storage/wetting cap (50 ml) for pH electrodes	0554 0048
Set case (plastic) for measuring instrument, probes and accessories	0516 0230
pH buffer solution 4.01 in dosing bottle (250 ml), including DAkkS calibration certificate	0554 2061
pH buffer solution 7.00 in dosing bottle (250 ml), including DAkkS calibration certificate	0554 2063
ISO calibration certificate analysis for pH buffer solutions; calibration points 4 pH, 7 pH, 10 pH	052 0007
ISO calibration certificate analysis at 3 pH values over the measuring range	05200037

9 Appendix

9.1. Electrode/application assignment

Key: - unsuitable, 0 suitable with reservations, + well suitable

New type designation	0650 2063	0650 1623	0650 0245	0650 2064	-	-	-	-
Old type designation	Type 01	-	Type 13	-	Type 02 ⁴	Type 03 ⁵	Type 04 ⁶	Type 05 ⁴
Application								
Waste water samples	+	+		+	0		+	+
General aqueous media	+	+		+	+		+	+
Aquarium	+	+		+	+		+	0
Beer, fruit juices, wine	0	+		0	0		0	+
Yoghurt, cheese		-	+	-		+		
Proteinaceous media	-	0	+	-	-	+	-	0
Emulsions, aqueous		+		0				+
Emulsions, partly aqueous		+		-				+
Soil (suspension)	0	+		-	0		0	+
Extreme pH-values (pH<1, >13)	0	0		-	0	-	0	+

⁴ No longer available, please check whether 0650 1623 is suitable for the application

⁵ No longer available, please check whether 0650 0245 is suitable for the application

⁶ No longer available, please check whether 0650 2064 is suitable for the application

New type designation	0650 2063	0650 1623	0650 0245	0650 2064	-	-	-	-
Old type designation	Type 01	-	Type 13	-	Type 02 ⁴	Type 03 ⁵	Type 04 ⁶	Type 05 ⁴
Application								
Meat in the puncture	-	-	+	-	-	0	-	-
Fruit, vegetable in the puncture	-	-	+	-	-	0	-	-
Hydrofluoric acid containing media	-	-		-	0	-	-	0
Plating-shop waste		+		-				+
Hot alkaline solutions	-	0		-	0	-	-	-
Highly viscous solutions		0		-	0	0		-
Infusions		+		0	0			+
Low ion media	-	0		0	0		0	0
Jam		-	+	-		+		-
Cosmetics		0			0			-
Leather, paper	0	-		-	0		0	+
Milk		+	+	+	0	+		
Ultrapure water, rain water	-	+		0	0		0	0
Cream, stirred yoghurt		0	+	-	0	+		
Brine	0	+		+	+		+	+
Swimming pool	+	+		+	+		+	+
Soaps, detergents		+		-				+
Suspensions, aqueous		+		-				+
Suspensions, partly aqueous		+		-				+
Dough, bread		-	+	-		+		-

New type designation	0650 2063	0650 1623	0650 0245	0650 2064	-	-	-	-
Old type designation	Type 01	-	Type 13	-	Type 02 ⁴	Type 03 ⁵	Type 04 ⁶	Type 05 ⁴
Application								
Partly aqueous solutions, > 10 % H ₂ O		+		-	0			+
Partly aqueous solutions, < 10 % H ₂ O		0		-				0
pH-measurement at temperatures up to 100 °C	-	-		-	+	-	-	-
Tris buffer solutions	0	+		+	0	-	0	+

In case of special demands and after special consultation special electrodes are available for the following applications:

- Lacquers and paints
- highly viscous solutions
- photographic solutions
- measurements on clean surfaces and for measurements at T < 0 °C.

9.2. Buffer table

The table below lists the temperature related changes to the buffers. (DIN buffer acc. to DIN 19266)

In the calibration this is automatically accounted for.

°C	DIN buffer				Testo buffer		
	1.685	4.006	6.865	9.180	4.00	7.00	10.00
10	1.670	4.000	6.923	9.332	4.00	7.07	10.18
15	1.672	3.999	6.900	9.276	4.00	7.04	10.14
20	1.675	4.001	6.881	9.225	4.00	7.02	10.06
25	1.679	4.006	6.865	9.180	4.00	7.00	10.00
30	1.683	4.012	6.853	9.139	4.01	6.99	9.95
35	1.688	4.021	6.844	9.102	4.02	6.98	9.91
38	1.691	4.027	6.840	9.081			
40	1.694	4.031	6.838	9.068	4.03	6.97	9.85
45	1.700	4.043	6.834	9.038			
50	1.707	4.057	6.833	9.011	4.05	6.96	9.78
55	1.715	4.071	6.834	8.985			
60	1.723	4.087	6.836	8.962	4.08	6.96	9.75