

INSTRUCTION MANUAL

BK PRECISION[®]

MODELS 1653A & 1655A



**Isolated-Variable
AC POWER SUPPLY**

BK PRECISION[®]

TEST INSTRUMENT SAFETY

WARNING

An electrical shock causing 10 milliamps of current to pass through the heart will stop most human heartbeats. Voltage as low as 35 volts dc or ac rms should be considered dangerous and hazardous since it can produce a lethal current under certain conditions. Higher voltages are even more dangerous. Your normal work habits should include all accepted practices to prevent contact with exposed high voltage, and that will steer current away from your heart in case of accidental contact with a high voltage. You will significantly reduce the risk factor if you know and observe the following safety precautions:

1. The **B+K Precision** Models 1655A and 1653A AC Power Supplies are sources of high voltage ac. The person using the instrument should be a qualified electronics technician or otherwise trained and qualified to work with high voltage.
2. Use only a polarized 3-wire ac outlet. This assures that the power supply chassis, case, and ground terminal are connected to a good earth ground and reduces danger from electrical shock.
3. When servicing any equipment equipped with a two-wire ac plug, treat it as “hot chassis” type and connect it to the ISOLATED OUTPUT outlet of the ac power supply. Even some equipment with a polarized plug is the “hot chassis” type.
4. Never connect two pieces of “hot chassis” equipment to ISOLATED OUTPUT outlets simultaneously. There may be a serious shock hazard between two chassis.
5. Don't expose high voltage needlessly. Remove housings and covers only when necessary. Turn off equipment while making test connections in high-voltage circuits. Discharge high-voltage capacitors after removing power.
6. If possible, familiarize yourself with the equipment being tested and the location of its high voltage points. However, remember that high voltage may appear at unexpected points in defective equipment.
7. Use an insulated floor material or a large, insulated floor mat to stand on, and an insulated work surface on which to place equipment; and make certain such surfaces are not damp or wet.
8. Use the time proven “one hand in the pocket” technique while handling an instrument probe. Be particularly careful to avoid contacting a nearby metal object that could provide a good ground return path.
9. When testing ac powered equipment, remember that ac line voltage is usually present on some power input circuits such as the on-off switch, fuses, power transformer, etc. any time the equipment is connected to an ac outlet, even if the equipment is turned off.
10. Never work alone. Someone should be nearby to render aid if necessary. Training in CPR (cardio-pulmonary resuscitation) first aid is highly recommended.

TABLE OF CONTENTS

	page
TEST INSTRUMENT SAFETY	inside front cover
FEATURES	3
SPECIFICATIONS	4
CONTROLS AND INDICATORS	6
OPERATING INSTRUCTIONS	12
Precautions	12
Troubleshooting: Using the AC Power Supply as an Isolation Transformer	16
Troubleshooting: Using the AC Power Supply as a Variable AC Voltage Source.	21
Troubleshooting: Using the AC Power Supply to Measure Electrical Loads.....	23
Using the Model 1655A as a Leakage Tester	25
Soldering Iron Temperature Control.....	27
	page
CIRCUIT DESCRIPTION.....	29
MAINTENANCE AND CALIBRATION.....	30
Preventive Maintenance.....	30
Returning for Service.....	30
Fuse Replacement.....	30
Auto-Transformer Brush Replacement.....	31
Calibration Adjustments.....	31
Performance Tests.....	34
Troubleshooting.....	35
CUSTOMER SUPPORT.....	37
WARRANTY INFORMATION.....	37
Warranty Service Instructions.....	38
Spanish Manual.....	39

FEATURES

Unless otherwise stated, all information in this section applies equally to Model 1653A and 4655A

WIDE VOLTAGE RANGE

Output voltage continuously variable from 0 to 150VAC.

WIDE CURRENT RANGE

Model 1655A

Heavy duty unit handles virtually all servicing needs. Output current up to 3 amps continuous, 4 amps intermittent.

Model 1653A

Handles many servicing needs. Output current up to 2 amps continuous.

WIDE LOAD MEASUREMENT CAPABILITY

Model 1655A

Built in multi-function meter. 0-150V. Two current ranges of 0-2A and 0-4A for improved resolution. Current scales also calibrated in VA at 120V.

Model 1653A

Built in dual-purpose meter measures output voltage from 0-150V and output current from 0-2A.

ISOLATED OUTPUT VOLTAGE

Built-in isolation transformer for safe servicing of "hot chassis" equipment. One isolated outlet on Model 1653A, two isolated outlets on Model 1655A for greater convenience.

BUILT-IN METER

Model 1655A

3-1/4 inch meter. Multi-color scales. Overrange protection

Model 1653A

2 inch meter. Overrange protection.

---Model 1655A offers the following additional features---

POWER LINE LEAKAGE TEST

OSHA, UL, and CSA power line leakage test capability; fast and safe measurement.

EXPANDED LEAKAGE SCALE

0-5mA (0-5000 μ A) leakage scale is expanded in most commonly used 100-500 μ A portion, compressed to 5 mA full scale. Overload protected.

CIRCUIT BREAKER OVERLOAD PROTECTION

Isolated output protected by easily reset circuit breaker.

SOLDERING IRON TEMPERATURE CONTROL

Built-in solid state soldering iron temperature control

SPECIFICATIONS

MODEL 1655A

OUTPUT ISOLATION

Leakage less than 0.1mA (25°C, 50% relative humidity.)

VOLTAGE ADJUSTMENT RANGE

0-150VAC, with input at 120VAC

VOLTAGE/CURRENT SENSING

Sine wave average, calibrated in RMS

MAXIMUM CURRENT (Isolated)

3A continuous, 4A intermittent (0-130V). Intermittent not to exceed 4 minutes at 4A followed by 5 minutes at 1A max.

METER SCALES

Voltage:0-150V

Current: 0-2A

..... 0-4A

Volt-Amps (Voltage Set to 120)..... 0-240VA

..... 0-480VA

Leakage0 to 5mA (5,000µA), expanded scale

METER ACCURACY (25°C)

Volts:.....±5% of full scale (calibrated @ 120VAC)

Current:.....±5% of full scale

Leakage:.....±5% @ 500µA

MODEL 1653A

OUTPUT ISOLATION

Leakage less than 0.1mA (25°C, 50% relative humidity)

VOLTAGE ADJUSTMENT RANGE

0-150VAC, with input at 120VAC

VOLTAGE/CURRENT SENSING

Sine wave average, calibrated in RMS.

MAXIMUM CURRENT (Isolated)

2A continuous (0-130V).

METER SCALES

Voltage:.....0-150V

Current:.....0-2A

METER ACCURACY (25°C)

Volts:.....±5% of full scale (calibrated @ 120VAC)

Current:.....±5% of full scale

SPECIFICATIONS

MODEL 1655A

AC INPUT

120 VAC, 60Hz, 600 VA

OPERATING TEMPERATURE RANGE

0° C to +40°C.

STORAGE TEMPERATURE

-30° C to +60°C.

WEIGHT

22lb (10kg.)

DIMENSIONS (WxHxD)

10.5" x 5.7" x 12" (267 x 145 x 305 mm)

PEAK CURRENT (Inrush)

30 A max (inrush limited to one cycle at 30A).

SOLDER IRON TEMPERATURE CONTROL

70% - 99% of power line (100W max).

MODEL 1653A

AC INPUT

120 VAC, 60Hz, 300 VA

OPERATING TEMPERATURE RANGE

0°C to +40°C.

STORAGE TEMPERATURE

-30°C TO +60°C.

WEIGHT

12 lb (5.5 kg).

DIMENSIONS (WxHxD)

5.5" x 6.5" x 10.5" (140 x 165 x 267 mm).

NOTE: Specifications and information are subject to change without notice.

CONTROLS AND INDICATORS

FRONT PANEL CONTROLS

(Refer to Fig. 1 and 2)

1. **POWER ON Switch.**
2. **POWER ON Pilot Light.**
3. **Function Switch.**

Model 1655A

Five interlocking pushbutton switches which select function and meter scale. Pressing a button releases the previous selection. The following selections are available:

VOLTS. Connects meter to measure voltage at ISOLATED OUTPUT. Use 0-150 VOLTS scales on meter. Voltage is adjustable with AC VOLTS control.

AMPS 0 – 4. Connects meter to measure current of ISOLATED OUTPUT. USE 0-4 AMPS scale on meter. When voltage is set to 120 VAC, the 0-480 VA scale may be used to measure the output load in volt-amperes.

AMPS 0-2. Connects meter to measure current of ISOLATED OUTPUT. Use 0-2 AMPS scale on meter. When voltage is set to 120VAC, the 0-240VA scale may be used to measure the output load in volt-amperes.

LEAKAGE COM. Connects meter to measure leakage with respect to common side of ac line. Use LEAKAGE scale on meter. Voltage must be preset to 120VAC for accurate leakage measurements.

LEAKAGE HOT. Connects meter to measure leakage with respect to hot side of ac line. Use LEAKAGE scale on meter. Voltage must be preset to 120VAC for accurate leakage measurements.

Model 1653A

Alternate action pushbutton switch selects function of meter. Push once to latch button in AMPS (in) position. Push again to release button to VOLTS (out) position. The following selections are available:

VOLTS. Connects meter to measure voltage at ISOLATED OUTPUT. Use 0-150 VOLTS scale on meter. Voltage is adjustable with AC Volts control.

AMPS. Connects meter to measure current of ISOLATED OUTPUT. Use 0-2 AMPS scale on meter.

4. **Meter.** Appropriate scale is selected by function switch.
5. **AC VOLTS Control.** Adjusts voltage at ISOLATED OUTPUT receptacle(s) from 0 to 150 volts.

CONTROLS AND INDICATORS

6. **ISOLATED OUTPUT Receptacle(s).** Isolated, variable ac voltage outlet(s). The equipment under test plugs in here. Single outlet on Model 1653A. Dual outlets on Model 1655A.
7. ***Leakage Probe.** With LEAKAGE function selected, touching probe tip to exposed metallic parts of equipment under test checks power line leakage.
8. ***SOLDER TEMP Control.** Full counterclockwise rotation turns off soldering iron outlet on rear panel. Initial clockwise rotation turns on outlet at standby (warm) temperature. Further clockwise rotation increases soldering iron temperature. Temperature adjustment is tapered, allowing fine adjustment of “hot” temperature at upper end of adjustment range. This control is completely independent of the POWER ON switch.
9. ***Solder Temp Pilot Light.** Lights whenever soldering iron outlet on rear panel is powered.

REAR PANEL CONTROLS

(Refer to Fig. 3 and 4)

10. **AC Power Cord.**

*=Model 1655A Only.

11. **Fuse.**

Model 1655A

4A fuse protects auto-transformer against excessive output current at low voltages which may not trip the input circuit breaker.

Model 1653A

3A line fuse protects against excessive input current. An internal 3A fuse protects against excessive output current at low voltages which may not blow the input fuse.

12. ***Circuit Breaker.** 3.15A circuit breaker protects against excessive input current. Remove overload and push to reset.
13. ***Soldering Iron Outlet.** AC outlet for soldering iron. Duty cycle, and thus temperature, is variable with SOLDER TEMP control on front panel. This outlet is intended only for non-transformer type soldering irons rated at 100 watts or less.

*=Model 1655A Only

CONTROLS AND INDICATORS

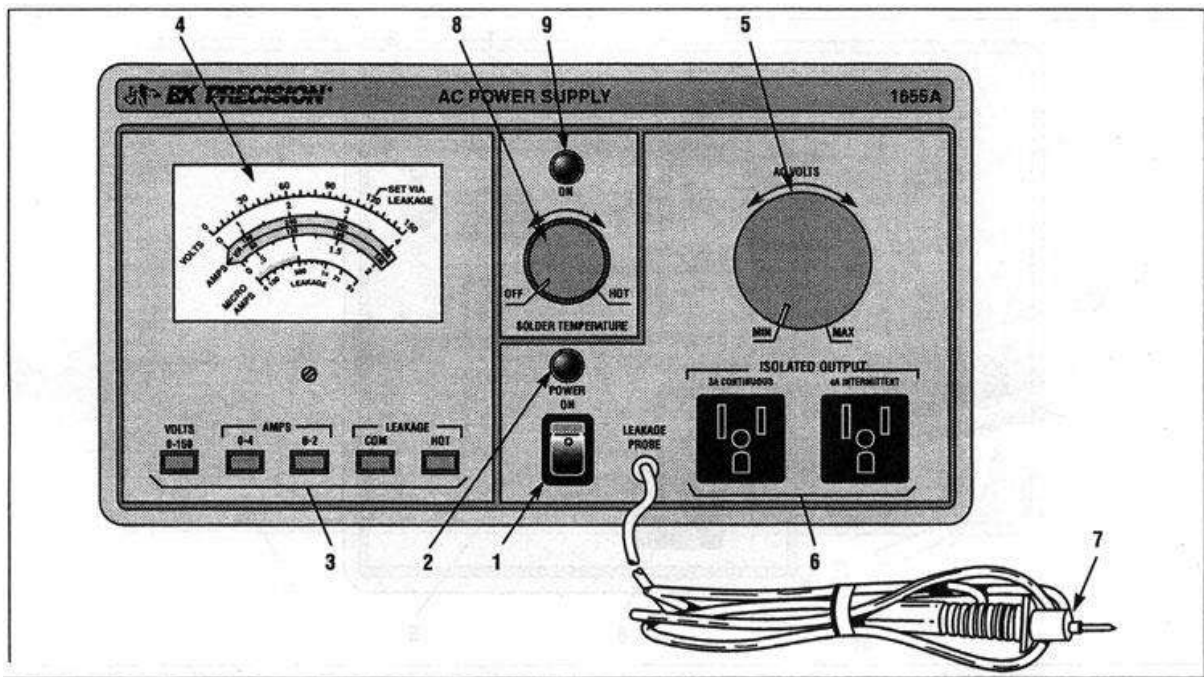

Figure 1. Front Panel Controls and Indicators, Model 1655A

CONTROLS AND INDICATORS

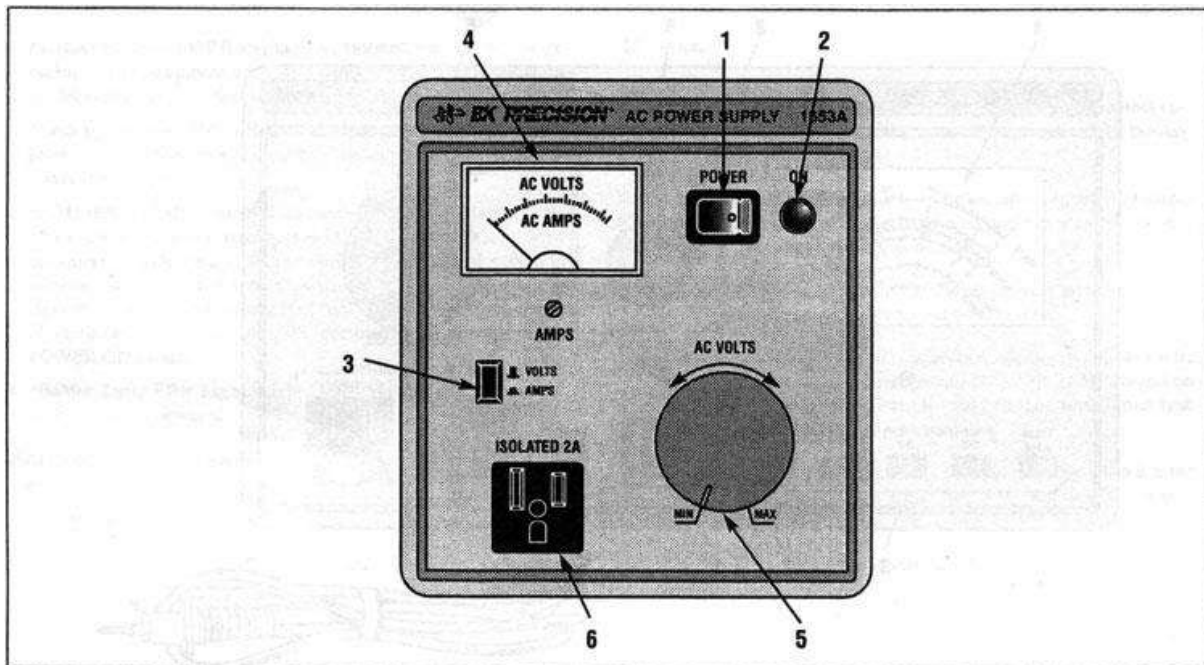

Figure 2. Front Panel Controls and Indicators, Model 1653A

CONTROLS AND INDICATORS

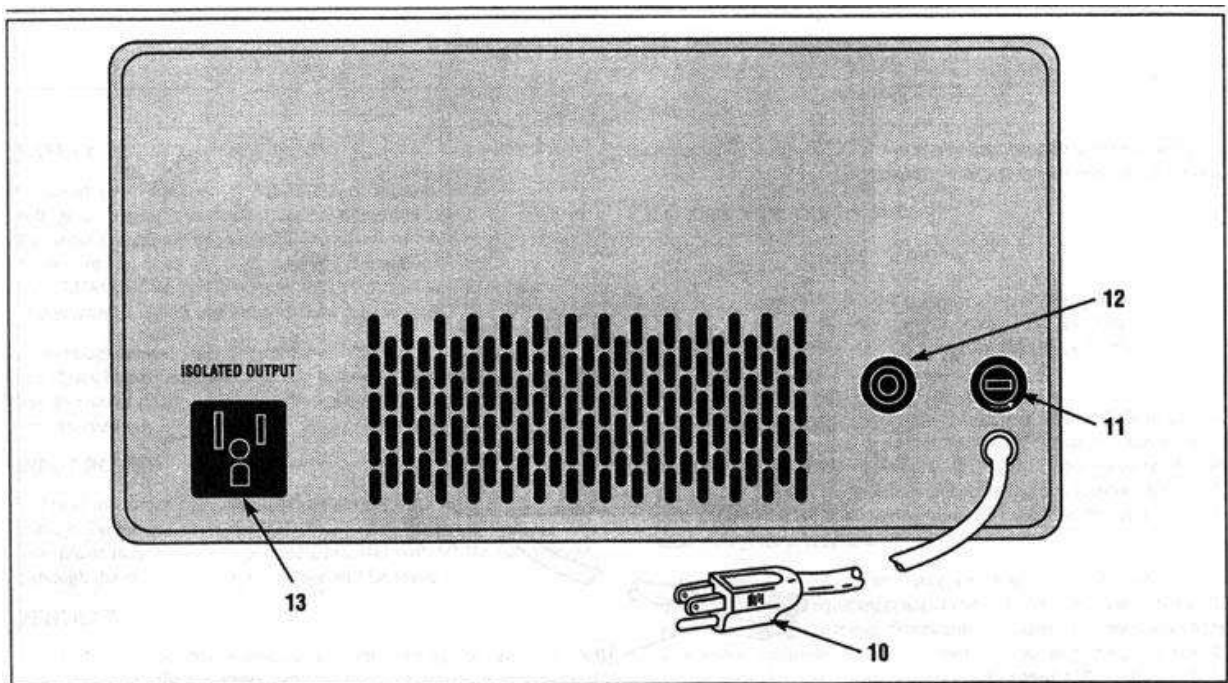

Figure 3. Rear Panel Controls and Indicators, Model 1655A

CONTROLS AND INDICATORS

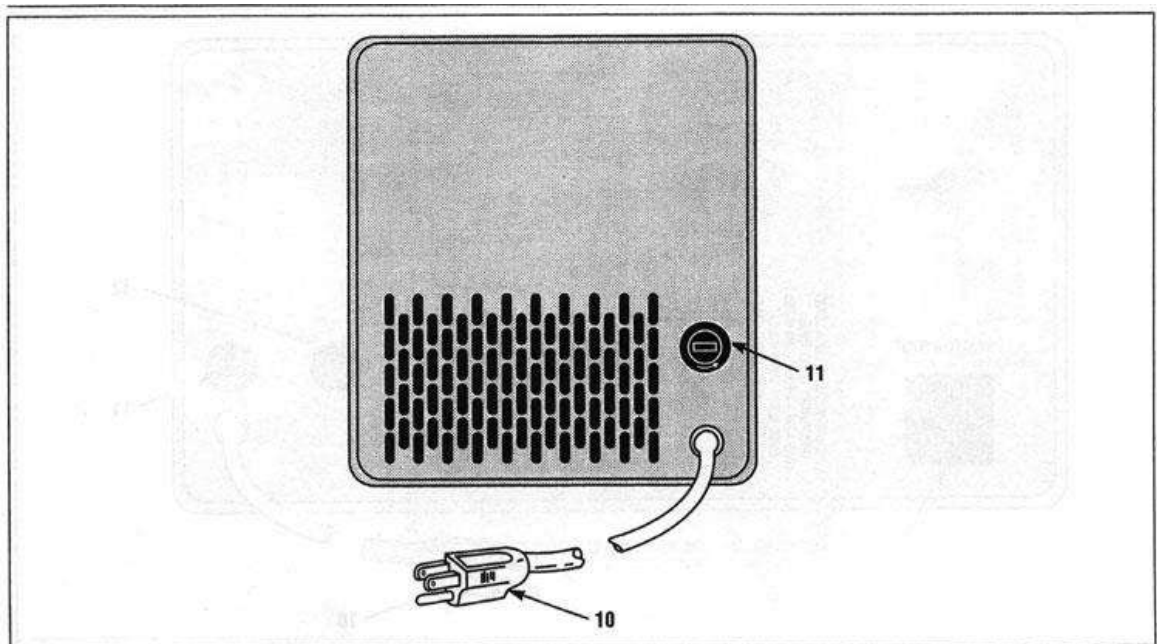

Figure 4. Rear Panel Controls and Indicators, Model 1653A

OPERATING INSTRUCTIONS

PRECAUTIONS

SAFETY

The Model 1655A and 1653A AC Power Supplies are sources of high voltage ac. Improper or careless use could result in fatal electrical shock. The most commonly encountered conditions which may pose a shock hazard are identified and corresponding precautions listed in the TEST INSTRUMENT SAFETY section which starts on the side front cover of this manual. Know and observe these precautions.

Although Model 1655A is equipped with dual isolated outlets, only one "hot Chassis" equipment should be connected at a time. Unless the line-to-chassis relationship is identical, a shock hazard will exist between the two chassis.

INPUT POWER

These instruments are intended for use only with 120 volt, 60Hz line voltage. Do not operate from 50Hz, or 220-240 volt power systems. The instrument may be safely operated from 100 volt, 60Hz line voltage, although the maximum output voltage will be lower.

VENTILATION

The holes in the case provide convection cooling (hot air rises and escapes through the top vents, while cool air is drawn in to replace it through the bottom). Never block these ventilation holes with a manual, schematic diagram, other equipment, etc. If the air is blocked, the temperature inside the ac power supply may

become excessive and cause failure of the unit. Similarly, avoid operating locations near sources of heat.

MAXIMUM OUTPUT VOLTAGE

CAUTION

Exceeding the maximum input voltage rating of the equipment under test (typically 130VAC) may cause severe damage to the equipment.

The output voltage of the ac power supply is adjustable from 0 to 150VAC. This is very useful in certain testing situations for stressing equipment beyond its normal operating range to determine its breakdown point. However, for most testing and servicing applications, input voltages higher than the maximum specified by the manufacturer should be used with great precaution.

For normal testing and servicing, check the maximum input voltage specification of the equipment under test and make sure you do not adjust the output voltage of the ac power supply higher than that value. Most ac powered equipment has a maximum input voltage rating of 130VAC. If unsure of the maximum rating, do not exceed 130 VOLTS. On Model 1655A, the 130-150 volt portion of the VOLTS scale is red as a reminder that caution should be observed.

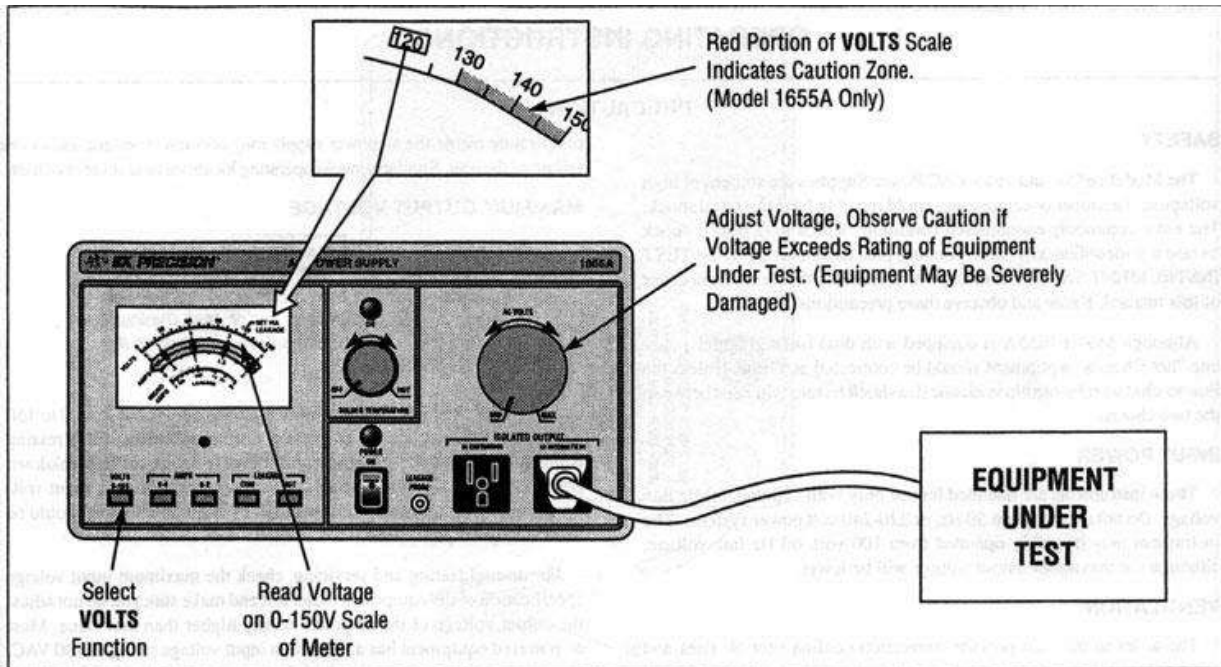

Figure 5. Observe Caution Above 130V.

OPERATING INSTRUCTIONS

Precautions

OPERATING INSTRUCTIONS

MAXIMUM OUTPUT CURRENT

CAUTION

NEVER EXCEED THE MAXIMUM OUTPUT CURRENT RATING OF THE UNIT (Table 1). Excessive output current can damage the variable auto-transformer.

Keep output current as low as possible; power only one piece of equipment at a time. Use the ISOLATED OUTPUT only for the equipment under test – not for the test equipment.

It is very important to observe the maximum current derating (Table 1) above 130 volts, and to allow sufficient cooling time when operating Model 1655A in the intermittent duty region.

Even at low voltages, the maximum output current should never exceed 4 amps for Model 1655A or 2 amps for Model 1653A. Higher current may damage the variable auto-transformer where the brush contacts the winding. A 3.15A circuit breaker limits maximum input current to Model 1655A, while a 3A fuse is used for Model 1653A. Additionally, output fuses limit the output of the 1655A to 4 amps and the 1653A to 3 amps at low voltages that would not open the input protective device. Never bypass the circuit breaker or fuses, or replace fuses with a higher value.

Remove the overload to reset the circuit breaker or replace a fuse. Turn off the unit when connecting or disconnecting equipment from the ISOLATED OUTPUT receptacle(s).

For Model 1655A, the red portion of the 0-4A scale of the meter indicates the caution zone (over 3A). This is a reminder that only intermittent duty operation is permitted.

For Model 1635A, the output current should not exceed 2 amps for continuous duty or intermittent duty operation. The full scale meter indication of 2A is a reminder that this is the maximum permissible output current.

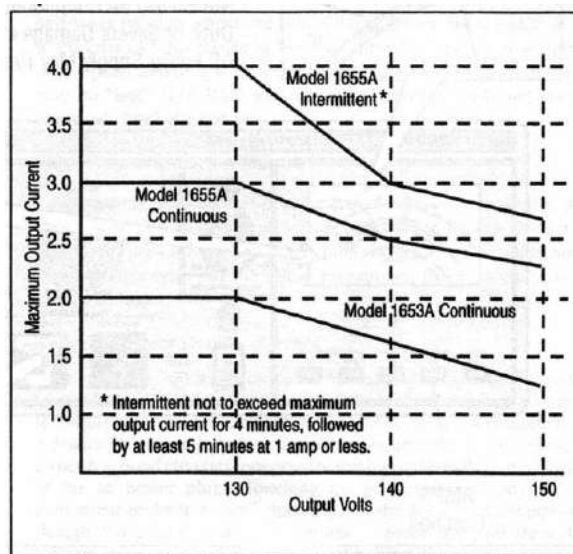

Table 1. Maximum Output Current Derating.

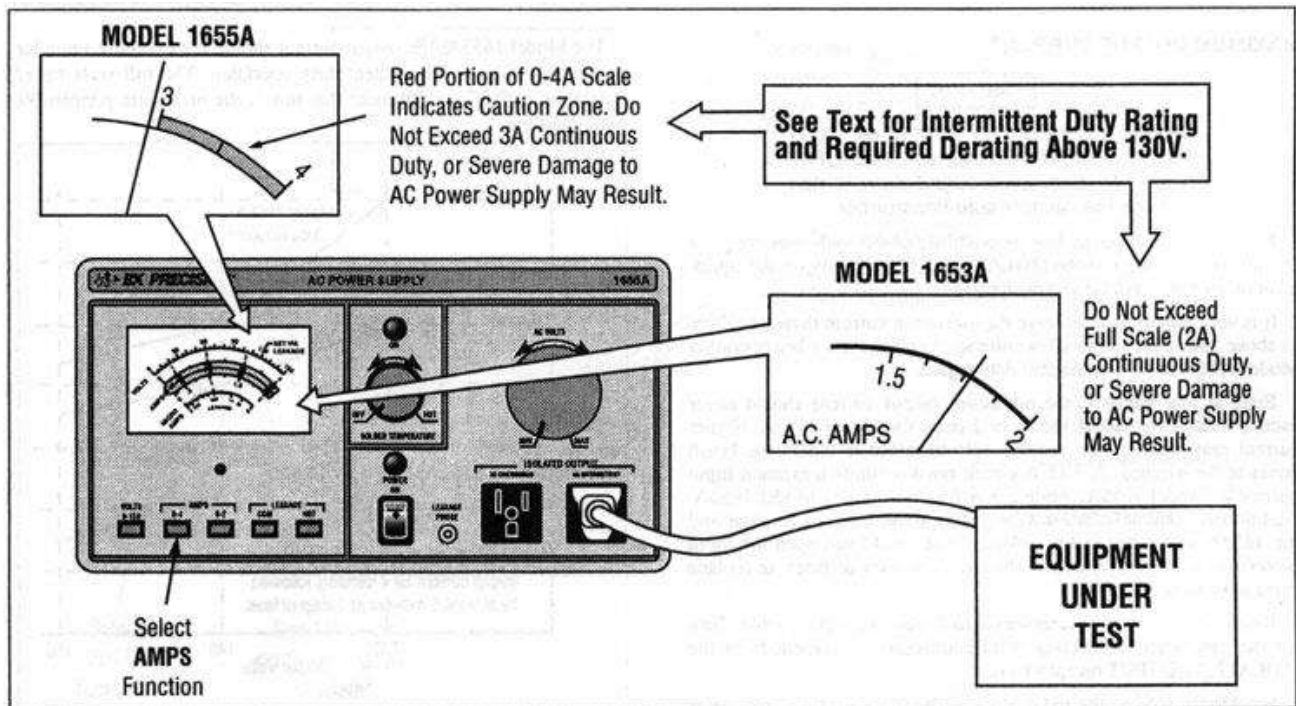

Figure 6. Maximum Current Considerations.

THE HAZARD**Most equipment with a 2-Wire Plug is Transformerless**

Most recent television receivers and other consumer products such as stereo amplifiers, tuners, tape decks, etc. do not contain an isolation transformer. Such products often have a plastic or wood cabinet which completely insulates the chassis and prevents the user from touching it. However, when the cabinet is removed for servicing the product, the chassis is exposed and may become an electrical shock hazard to the service technician.

Bridge Rectifier Transformerless Equipment

One of the most commonly used types of power supply circuits in television receivers and audio equipment is the transformerless full wave bridge rectifier shown in Fig 7. In such cases, the chassis is always “hot”, regardless of which way the 2-wire ac plug is inserted. Touching a “hot” chassis is hazardous and can cause fatal electrical shock.

WARNING

Just because a unit uses a polarized power plug does not guarantee safety. Some equipment with a bridge rectifier uses a polarized power plug, and as mentioned above, always has a “hot” chassis.

Transformerless Half-Wave Rectifier Equipment

Another commonly used transformerless power supply circuit is a half-wave rectifier where one side of the ac power line connects directly to the chassis (also shown in Fig. 7). Unless the equipment is equipped with a polarized plug to prevent insertion the “wrong” way, the chassis may be “hot” (120VAC with respect to earth ground) and cause an electrical shock if touched.

Other Transformerless Hazards

Equipment with voltage doubler power supplies may also be of the “hot Chassis” variety and pose the same safety hazard. In fact, and equipment with a 2-wire ac power plug should be treated as hazardous “hot” chassis type and the safety precautions listed on the next page should be taken.

Test Equipment Damage Hazard

In addition, to the electrical shock hazard if the “hot” chassis is touched, there is also a high probability of damaging any ac-powered test equipment used to service the equipment. Most test equipment with a 3-wire power cord, such as oscilloscopes and signal generators, have an earth ground chassis (connected to earth ground through the third wire of the ac power plug). Touching the ground lead of any such test equipment probe to a “hot” chassis shorts the hot side of the power line through the ground lead and instrument. Since the path through the instrument is intended only as a signal ground, the excessive current of a direct power line short may cause extensive damage to the test equipment or to the equipment under test.

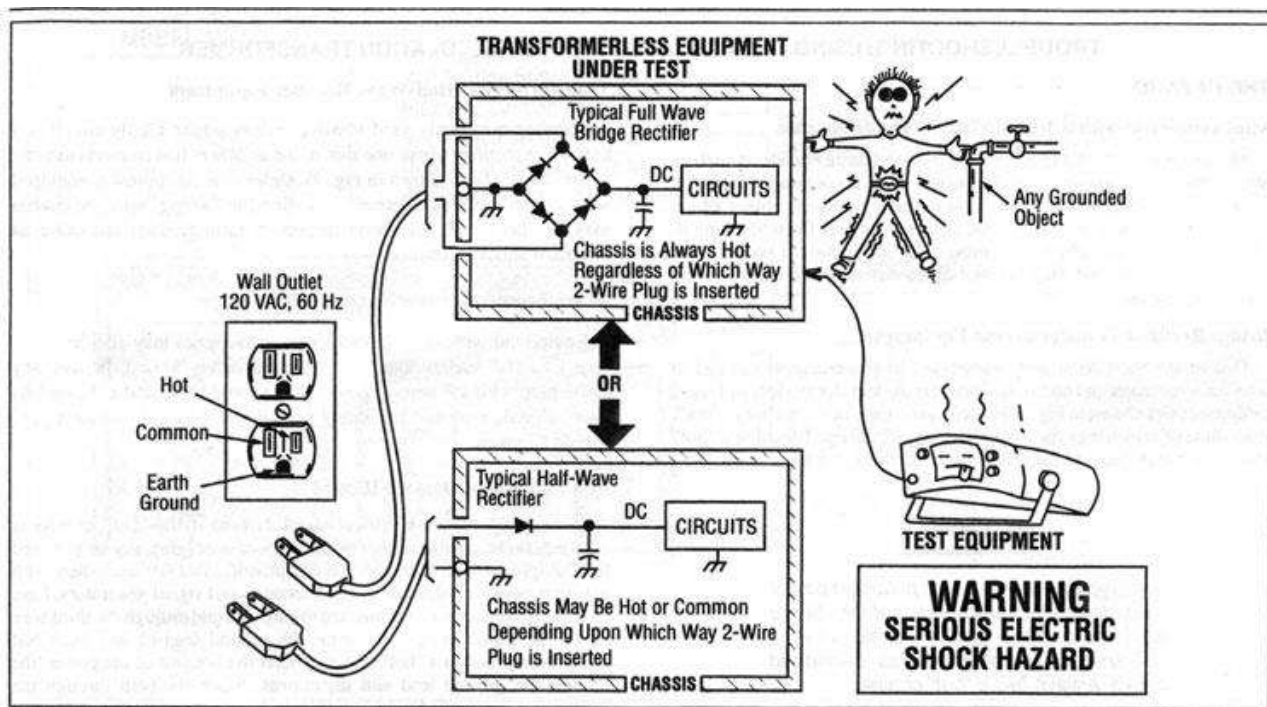

Figure 7. Servicing "Hot Chassis" Equipment Can Pose a Serious Shock Hazard.

THE SOLUTION

Don't Ground the Chassis

Simply connecting a test lead from the chassis to a good earth ground is not a satisfactory solution. If the chassis is "hot", this places a direct short from the "hot" side of the power line to earth ground. Hopefully, this would only trip the circuit breaker for the wall outlet. But a wall outlet is a very high energy source, and before the circuit breaker is tripped, the grounding test lead may "weld" or "disintegrate", or severe damage may occur to the equipment under test.

Use An Isolation Transformer

For servicing "Hot Chassis" equipment, always connect an isolation transformer between the wall outlet and the equipment under test. The Model 1655A or 1653A AC Power Supply includes such an isolation transformer, among its many other features.

As shown in Fig. 8, when an isolation transformer is used, the chassis of the equipment under test is electrically isolated from both sides of the power line. The chassis of the equipment under test may not be grounded by connecting a test lead from the chassis to a convenient earth ground (such as an earth ground terminal of the test equipment).

Summary

Any piece of equipment with a 2-wire power plug may be the "hot chassis" type, even if it is equipped with a polarized plug. There is not disadvantage to using an isolation transformer, even if the equipment under test already includes its own isolation transformer. Therefore, for safety, treat all equipment with a 2-

wire power cord as "hot chassis" and use the ISOLATED OUTPUT of the 1655A or 1653A AC Power Supply for servicing such equipment.

PROCEDURE

(refer to Fig. 9)

1. Turn off the 1655A or 1653A AC Power Supply and set AC Volts control to MIN.
2. Connect the power plug of the ac power supply to a 120 volt, 60 Hz ac wall outlet. The wall outlet must be the 3-wire type with the third wire returned to a good earth ground.
3. Connect any ac powered test equipment to be used to an ac wall outlet (do not use the ISOLATED OUTPUT receptacles of the ac power supply for test equipment).
4. Connect the ac power plug to the equipment under test to the ISOLATED OUTPUT receptacle of the ac power supply. This provides the isolation as shown in Fig. 8.

WARNING

CONNECT ONLY ONE "HOT CHASSIS" EQUIPMENT AT A TIME. Unless both have an identical line-to-chassis relationship, there is a shock hazard between two chassis.

5. Turn the POWER ON.
6. Select VOLTS function and adjust AC VOLTS control to desired voltage (typically 120V).
7. It is recommended that the chassis of the equipment under test be grounded with a test lead.

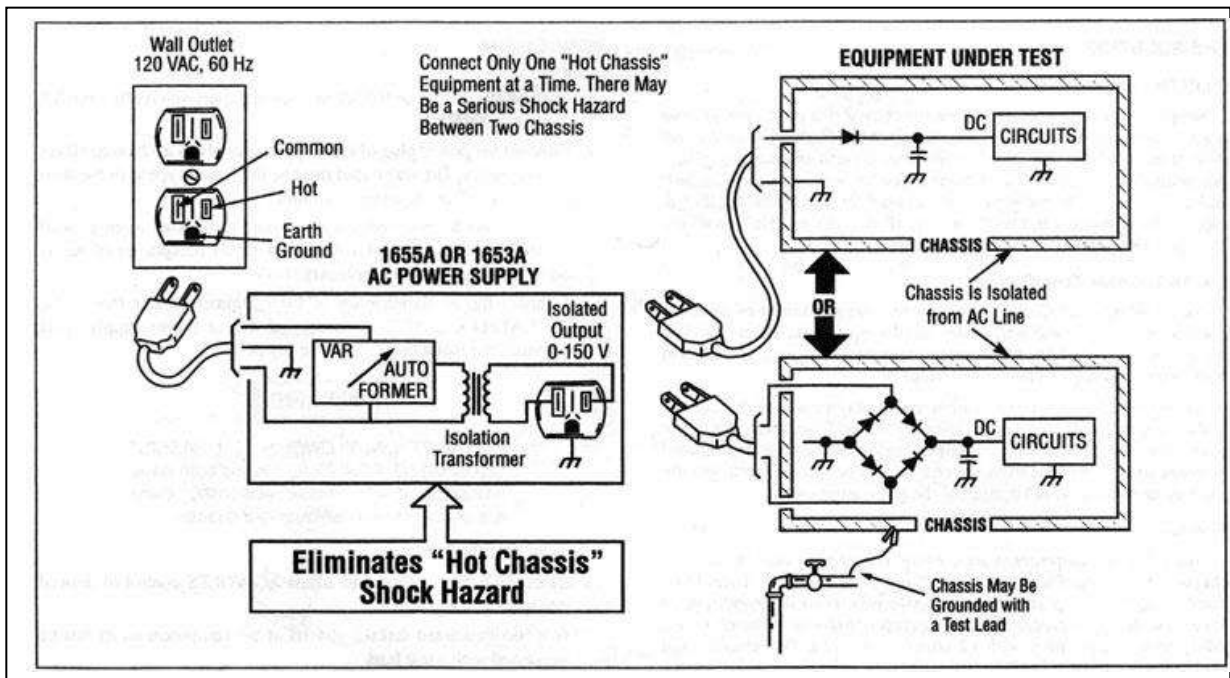

Figure 8. Eliminating the Hazard of Servicing Transformerless Equipment

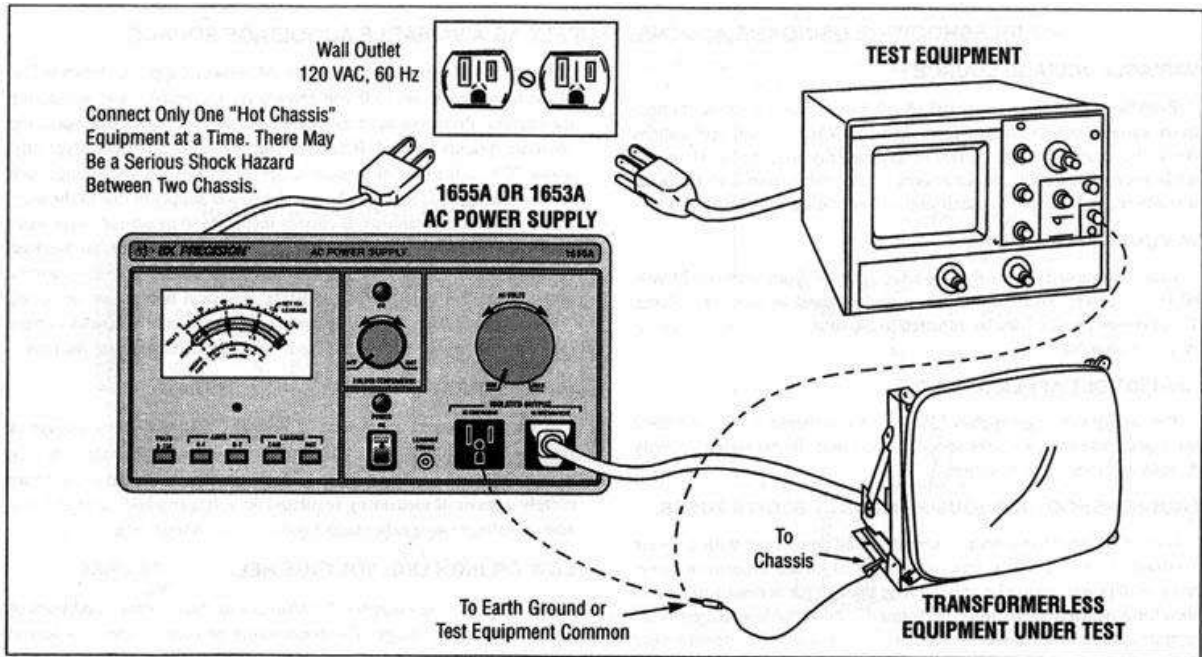

Figure 9. Using the AC Power Supply as an Isolation Transformer

TROUBLESHOOTING: USING THE AC POWER SUPPLY AS A VARIABLE AC VOLTAGE SOURCE**VARIABLE VOLTAGE SOURCE**

Both the Model 1655A and 1653A AC Power Supplies offer continuously variable output voltage from 0 to 150VAC. Several applications are listed below, but the versatile instruments may be used in any application where an ac power source of any value from 0 to 150 volts is required, and within the maximum current rating of the instrument.

24 VOLT APPLICATIONS

Class II industrial control equipment operates from nominal 24 volt, 60 Hz ac power. Such equipment is widely used in industrial plants. These power supplies can be adjusted to 24 volts ac for bench servicing of the equipment.

130-150 VOLT APPLICATIONS

The ability to go higher than 130 volts is indispensable in component and equipment testing where specifications must be exceeded to verify designs and overvoltage margins.

TROUBLESHOOTING EQUIPMENT THAT BLOWS FUSES

One of the problems with troubleshooting equipment with a severe overload or short is that it repeatedly trips its circuit breaker or blows fuses. Full power cannot be applied long enough for normal voltage and waveform measurements to be performed. The variable voltage feature permits operation at a lower voltage that does not activate the protective device; testing and troubleshooting can be performed with power applied.

Using the Model 1655A or 1653A AC Power Supply as shown in Fig. 10, voltage can be set to 0 volt and slowly increased while monitoring the current. Problems such as a defective circuit breaker that open too soon are quickly spotted. If current reaches its normal value (typically, about 70% of the fuse or protective device rating) at a low voltage such as 20 volts, there is a major short in the power supply or one of the main power distribution circuits. If current increases to its normal value more gradually, allowing voltage to approach 100 volts or more, an overload in one of the circuits is probably the cause. Current that increases sharply above a certain voltage may indicate electrical breakdown or arcing within a component. Voltage or current measurements in various circuits (see Fig. 10) while varying the input voltage can help isolate the fault.

INPUT VOLTAGE SPECIFICATION TESTING

Most ac powered equipment is specified to operate over a range of input voltage such as 120VAC \pm 10%. Complete performance testing cannot be conducted without a variable ac source. Some testing may merely consist of measuring regulated dc voltages while varying the ac source voltage; with other tests conducted at nominal line voltage.

LOW OR HIGH LINE VOLTAGE RELATED FAILURES

Occasionally, an equipment malfunctions only during conditions of low or high line voltage. Troubleshooting of such problems is almost impossible without a variable ac voltage source. Either Model 1655A or 1653A AC Power Supply serves as a variable ac voltage source.

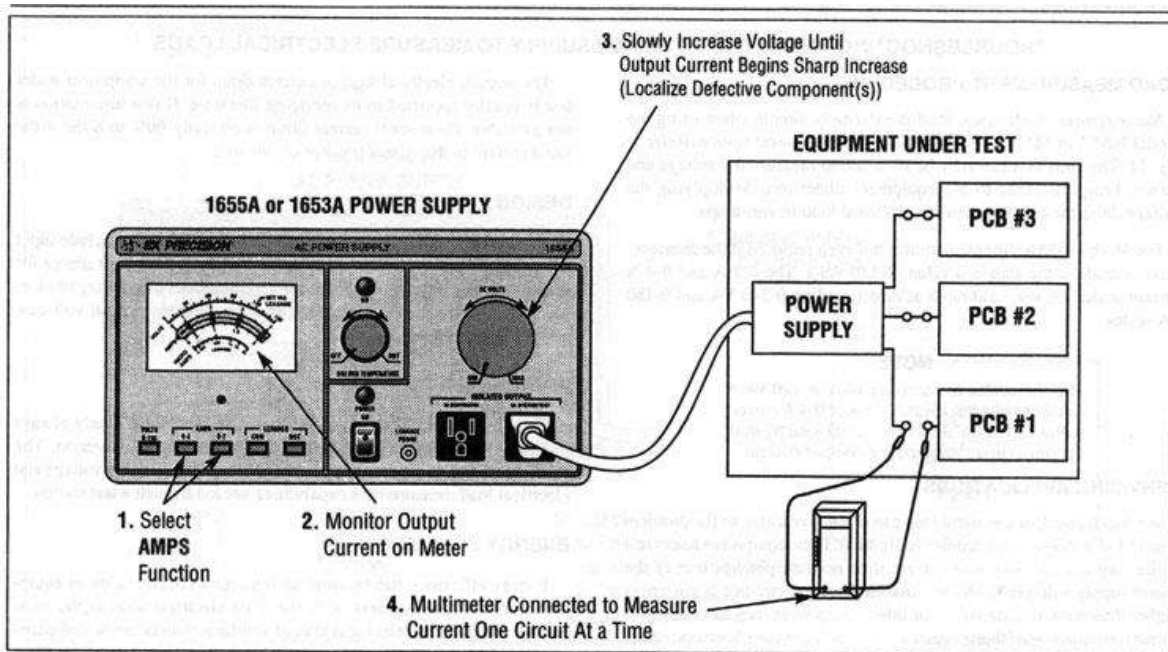

Figure 10. Using the Variable Voltage Feature to Troubleshoot Equipment with Short Circuit

OPERATING INSTRUCTIONS

Troubleshooting: Load Measurement

TROUBLESHOOTING: USING THE AC POWER SUPPLY TO MEASURE ELECTRICAL LOADS

LOAD MEASUREMENT PROCEDURE

Measurement of electrical load is extremely simple when using the Model 1655A or 1653A AC Power Supply as the power source. Refer to Fig. 11. The built-in meter may be switched to measure the voltage and current being delivered to the equipment under test. Multiplying the voltage times the current give the electrical load in volt-amps.

For Model 1655A the calculations is not even required if the measurement is made at the standard value of 120 volts. The 0-2A and 0-4A current scales are also calibrated as direct reading 0-24VA and 0-480VA scales.

NOTE

The VA scales are accurate only at 120 volts. At other voltages, use the 0-2A or 0-4A current scales and calculate the electrical load by multiplying output voltage times output current.

SERVICING APPLICATIONS

An initial check of electrical load can often give a clue to the problem when troubleshooting electronics equipment. If the equipment under test is drawing considerably less current than normal, perhaps one of the power supply voltages is absent, disabling several circuits. If current is higher than normal, a transistor or other component may be shorted. If current remains higher than normal after other faults have been corrected, a leaky filter capacitor is suspected. Such problems should be corrected to prevent another impending failure.

The normal electrical load or current drain for the equipment under test is usually specified in its servicing literature. If that information is not available, the normal current drain is typically 60% to 80% of the rated current of the circuit breaker or line fuse.

DESIGN APPLICATIONS

The design goals of any ac powered electronic product include input power requirements. Using the ac power supply as the power source for breadboard and prototype units provides continuous monitoring of electrical load for various circuit configurations, at various input voltages, and at various temperatures.

PRODUCTION TESTING

Final testing of electrical and electronics equipment nearly always includes monitoring of electrical load in all modes of operation. The **B+K Precision** ac power supplies provide both variable voltage and electrical load measure meant capabilities needed in such a test station.

ENERGY EFFICIENCY

Energy efficiency has become an important consideration in equipment selection. Equipment with the least electrical load is the most energy efficient. The electrical load of similar products can be compared side by side, demonstrating energy efficiency to a customer in terms readily understood by a layman.

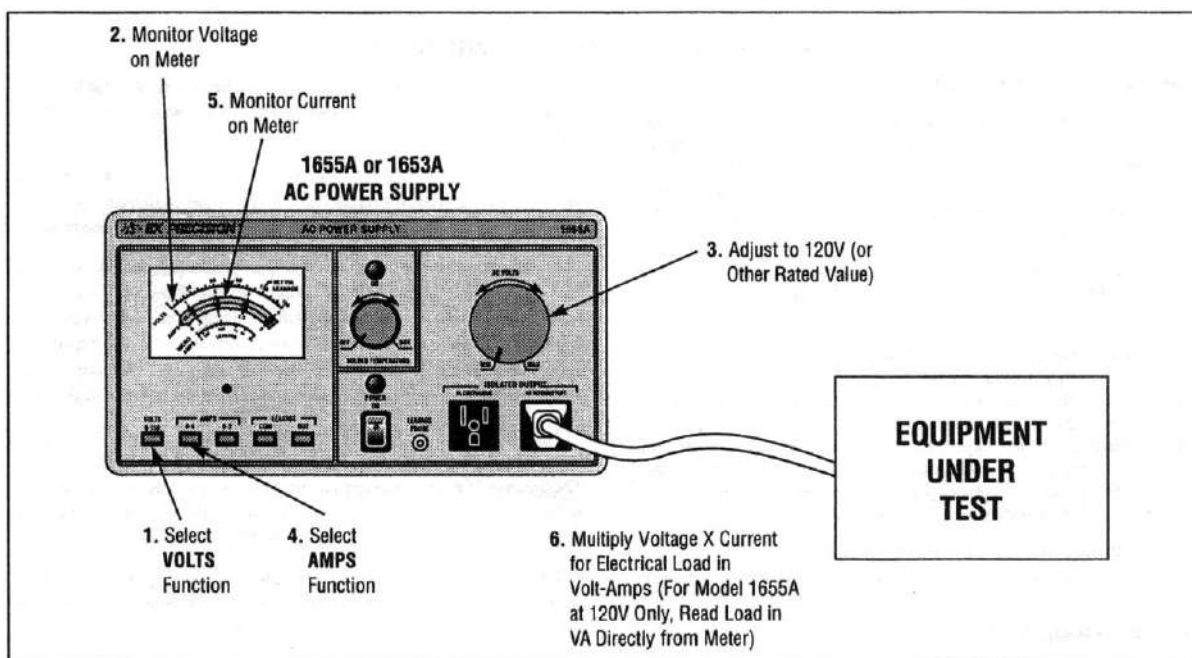

Figure 11. Measuring Electrical Load

USING THE MODEL 1655A AS A LEAKAGE TESTER**STANDARD LEAKAGE TEST**

As previously mentioned, most equipment with a 2-wire ac power plug is the “hot chassis” type. The plastic or wood cabinet normally insulates the chassis so the user cannot touch it. Other exposed metal parts such as antennas, antenna terminals, knob shafts, screw heads, handles, etc. are also insulated (or isolated with very high resistance) to protect the user from electrical shock.

Most equipment manufacturers specify a leakage test after reassembly of the equipment to insure the continued protection of the user from electrical shock.

The standard leakage test requires a leakage probe consisting of a test lead in series with a 1.5k Ω , 10 watt resistor parallel by a 0.15 μ F capacitor. One end of the leakage probe is connected to an earth ground. Voltage across the resistor is measured on an ac voltmeter as the leakage probe is touched to each exposed metal part of the equipment. An isolation transformer must not be used during the standard leakage test, and the entire test must be repeated with the ac power plug reversed, even if an adapter is required to reverse the connections of a polarized plug.

The maximum permissible leakage specified by OSHA, UL, and CSA is 500 μ A. Some manufacturers specify a lower limit for a greater margin of safety.

THE SIMPLER METHOD

The Model 1655A AC Power Supply includes a built-in leakage tester that greatly simplifies the leakage test (Fig. 12).

The equipment under test remains connected to the ISOLATED OUTPUT, just as if it was for servicing. The voltage was probably already preset to 120 volts at the conclusion of servicing.

The permanently attached leakage probe of the ac power supply is merely touched to each exposed metal part of the equipment under test (antenna, terminals, tuner knob, knob shafts, handle, screw heads, etc.)

No separate voltmeter nor conversion of results is required. Just press the LEAKAGE button and read leakage directly from the LEAKAGE scale of the meter in microamps (in milliamps for higher values of leakage). See the manufacturer’s service literature for the maximum permissible leakage. However, leakage in excess of 500 μ A is considered hazardous in any equipment. Locate and correct the cause of leakage.

The expanded scale meter gives good resolution in the normal 100 to 500 μ A range. Reading give up to 5mA are measured on a compressed scale. The amount of excess leakage can be a clue to the type of leakage path. A full scale meter reading probably indicates a direct short to the power line, but the meter is protected from damage.

The leakage probe may also be used to verify proper wiring of equipment with polarized plug; there should be very low leakage from the chassis to common and full scale leakage to hot.

Leakage of equipment with a 3-wire power plug is performed in the same manner as for 2-wire equipment.

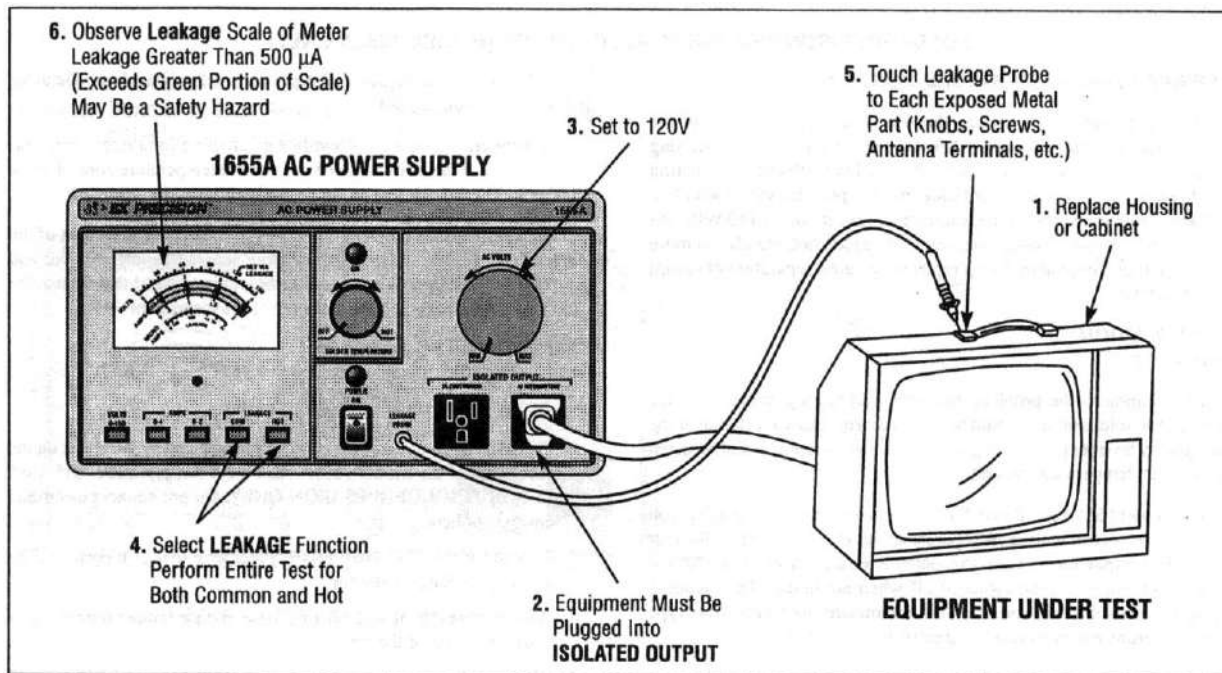

Figure 12. Power Line Leakage Testing.

OPERATING INSTRUCTIONS

Soldering Iron Temperature Control

SOLDERING IRON TEMPERATURE CONTROL (MODE 1655A ONLY)

THE NEED FOR TEMPERATURE CONTROL

Most servicing work requires the use of a soldering iron. If the soldering iron is plugged in only when it is needed, time is wasted waiting for the iron to heat up. But if it is left plugged in all the time, oxidation quickly erodes the tip. Also, soldering iron temperature varies with line voltage. Some irons reach the ideal temperature at 105 to 110 volts. As a result, at 120 volts, some soldering irons are too hot, which can more easily damage components being replaced or cause separation of circuit board plating.

THE SOLUTION

(refer to Fig. 13)

The solution to the problem just described is a variable ac voltage source. The soldering iron could be kept warm to reduce oxidation of the tip, quickly brought to operating temperature when needed, and adjusted to the exact temperature desired.

The Model 1655A AC Power Supply includes a built-in soldering iron temperature control feature. A separate ac outlet is provided on the rear panel. The output duty cycle at this outlet is variable from about 70% to 99%, or the outlet can be switched off when not in use. This outlet is intended for a soldering iron only. It is not intended for transformer type soldering irons nor irons rated at greater than 100 watts.

Temperature is adjusted with the SOLDER TEMP control on the front panel. A relatively low temperature setting is recommended between periods of soldering iron use to reduce

oxidation of the tip. This setting keeps the iron warm enough that it can be quickly brought to operating temperature when needed.

The temperature control is non-linear, allowing for a larger temperature variation at the low end and more precise temperature control at the HOT end. The exact temperature desired can be easily achieved.

The soldering iron temperature control is entirely independent of the isolated variable voltage output, including separate on-off switches and pilot lights. Thus the soldering iron temperature control feature may be used with or without the other features of the instrument.

SUMMARY OF PROCEDURE

(refer to Fig. 13)

1. Set the SOLDER TEMP control to OFF
2. Connect the ac power plug of the soldering iron to the outlet on the rear panel of the Model 1655A AC Power Supply. **THIS OUTLET IS FOR A SOLDERING IRON ONLY.** Do not connect electronic equipment here.
3. Turn the SOLDER TEMP control clockwise to the on position. The amber pilot lamp will light.
4. Between periods of soldering iron use, reduce temperature to minimize oxidation of the tip.
5. When ready to use the soldering iron, adjust the SOLDER TEMP control to the desired temperature. Experience will quickly determine the typical setting for a given soldering iron.

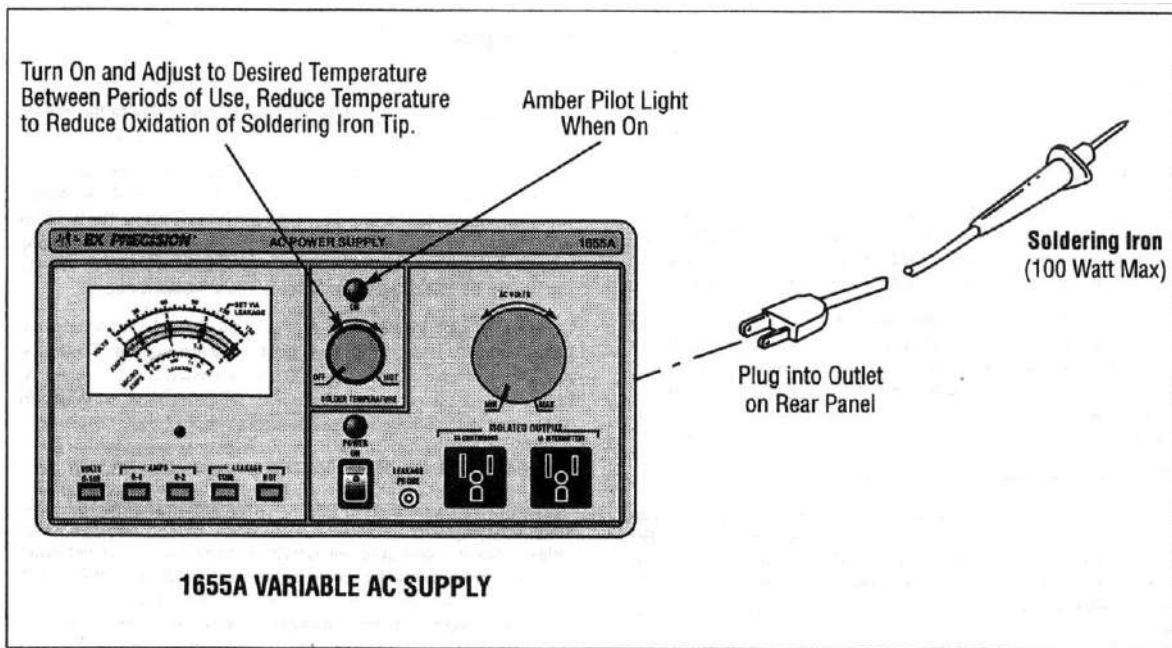

Figure 13. Using the Variable Soldering Iron Temperature Feature.

CIRCUIT DESCRIPTION

Refer to the separately supplied schematic diagram while reading the following circuit descriptions.

VARIABLE VOLTAGE CIRCUIT

Input power is applied through the POWER ON switch to variable auto-transformer T1. The output of T1 is set with the AC VOLTS control from 0 to 150 volts. The selected amount of voltage is applied across isolation transformer T2 to the ISOLATED OUTPUT receptacle(s).

Model 1653A is protected by input fuse F1, while Model 1655A uses circuit breaker CB1. This limits the maximum input current. Additional protection for the auto-transformer is offered by fuse F2, which limits the maximum output current at low voltages which would not open the protective device in the input circuit. In Model 1655A, this is a 4-amp fuse on the rear panel. In Model 1653A, a 3-amp internal fuse is used.

METERING CIRCUIT

Since the output of the unit is ac, the meter is connected across a bridge rectifier to provide the dc necessary for meter operation. The rectifier circuit senses the average level, while the meter is calibrated to read the equivalent rms value of a sine wave voltage the back-to-back diodes connected directly across the meter limit maximum voltage and thus offer overrange protection.

When the VOLTS function is selected, the voltage across the ISOLATED OUTPUT is applied to the meter circuit. The meter

is shunted by the VOLTAGE CAL trim pot which calibrates the voltage scale.

A 1-ohm current sensing resistor (two series 0.5-ohm in Model 1655A) develops a voltage proportional to output current. In the AMPS function, this voltage is applied across the meter circuit. The meter is now shunted by the AMPS CAL trim pot which calibrates the 2 amp current scale. In Model 1655A, the 4 amp scale is selected by sensing the voltage developed across only one of the 0.5-ohm resistors.

When the LEAKAGE function is selected (Model 1655A only) the current from the leakage probe is applied to the meter circuit. Diodes D4 and D5 are reverse biased below 500 μ A for expanded scale feature. At higher leakage current, the diodes become forward biased and shunt part of the current to compress the meter scale.

SOLDERING IRON TEMPERATURE CONTROL CIRCUIT

(Model 1655A Only) Input power is applied through triac TR1 to the soldering iron outlet on the rear panel. Breakdown diode D1 does not gate the triac into conduction until its 30 volt threshold is reached. Thus, the triac does not conduct for the entire input cycle. SOLDER TEMP control R2 forms part of an RC phase shift network which varies the phase of the trigger voltage in relation to the anode voltage of the triac. This varies the non-conduction period, which adjusts the soldering iron temperature. The circuit is automatically reset each time the ac passes through zero.

MAINTENANCE AND CALIBRATION

WARNING

1. *The following instructions are for use by qualified service personnel only. To avoid electrical shock, do not perform servicing other than contained in the operating instructions unless you are qualified to do so.*
2. *When the unit is plugged into an ac outlet, even if the POWER ON switch is off, ac line voltage is present as some input power circuits. Observe caution any time the case is removed from the instrument.*

PREVENTIVE MAINTENANCE

Do not overload the instrument. Excessive output current can damage the variable auto-transformer. Prolonged use at high current accelerates failure. Keep output current as low as possible, and never exceed the maximum rating of the unit. If possible, power only one piece of equipment at a time. Use the ISOLATED OUTPUT only for the equipment under test-not for other test equipment. It is very important to observe the maximum current derating (Table 1) above 130 volts, and to allow sufficient cooling time when operating Model 1655A at greater than 3 amps outlet.

Periodic inspection of the brush on the variable contact of the auto-transformer is recommended. Badly worn or arcing brushes should be replaced. See the AUTO-TRANSFORMER BRUSH REPLACEMENT paragraph for replacement procedures.

RETURNING FOR SERVICE

If you have encountered a problem with your unit and choose to return it for service, check the following before returning.

1. Is the circuit breaker reset (Model 1655A)? See FUSE REPLACEMENT paragraph below if required.
2. Are the fuses okay? See FUSE REPLACEMENT paragraph below if required.

FUSE REPLACEMENT

The ac power supply will trip its circuit breaker or blow a fuse only if it is severely overloaded or a failure occurs in the instrument. Always turn off the unit to reset the circuit breaker or replace a fuse. If fuses are internal, unplug the instrument from its wall outlet before attempting replacement. Before turning the unit back on, reduce the output voltage or remove the overload that caused the blown fuse. Replace the fuse only with the original type and value-never one of a large value. A larger value may create a fire and safety hazard, or cause serious damage to the equipment. Also refer to the following specific fuse replacement information for each model.

Model 1653A

If the instrument is severely overloaded at higher output voltages, fuse F1 on the rear panel will blow. The unit will stop operating and the pilot light will go off. If the instrument is severely overloaded at low output voltage, internal fuse F2 will blow. In this case, there will be no output but the pilot light will stay on. Fig. 14 shows the location of the fuses. Replace fuse F1 only with a 3-amp slow-blow type 3AG.

MAINTENANCE AND CALIBRATION

Model 1655A

If this instrument is severely overloaded at higher output voltages, circuit breaker CB1 on the rear panel will trip. The unit will stop operating and the POWER ON pilot light will go off. Remove the overload and push the button on the circuit breaker to reset. A severe overload at low output voltage will blow fuse F2 on the rear panel. In this case, there will be no output but the pilot light will stay on. If the soldering iron outlet is overloaded, internal fuse F1 will blow. If so, the SOLDER TEMP pilot light will go off. Fig. 15 shows the fuse locations. Replace fuse F1 only with a 1-amp normal blow type 3AG. Replace fuse F2 only with a 4-amp slow-blow type 3AG.

AUTO-TRANSFORMER BRUSH REPLACEMENT

To replace the brush, unplug the instrument, then gently lift the brush from the brush track. Grasp the old brush assembly and snap it out of position by pulling radially. Install the new brush assembly by lifting the spring arm and snapping the new brush assembly into position.

It is imperative that newly installed or re-installed brushes be seated correctly on the brush track for proper operation of the transformer. With the power off, insert a piece of garnet paper (non-metallic) between the brush and brush track, rough side toward the brush. A few swing of the brush over the garnet paper will mate the brush contact face to the brush track. Remove the garnet paper and blow away loose particles before applying power.

CALIBRATION ADJUSTMENTS

This unit was carefully checked and calibrated at the factory prior to shipment. Readjustment is recommended only if repairs have been made in a circuit that affects calibration, or if you have reason to believe the unit may be out of calibration. Locations of the calibration adjustments are shown in Fig. 14 (Model 1653A) and 15 (Model 1655A).

Test Equipment Required

1. Multimeter, ac voltage accuracy of 0.5% or better at 120 V, 60Hz, ac current accuracy of 1% or better at 500 microamps and 2 amps, 60Hz. **B+K Precision** Model 2831D or equivalent.
2. 60 ohm, 240 watt resistive power supply load. Must be capable of dissipating 2 amps at 120 VAC. A variable electronic load of sufficient power rating may be used, or parallel light bulbs totaling 240 watts are suitable.

MAINTENANCE AND CALIBRATION

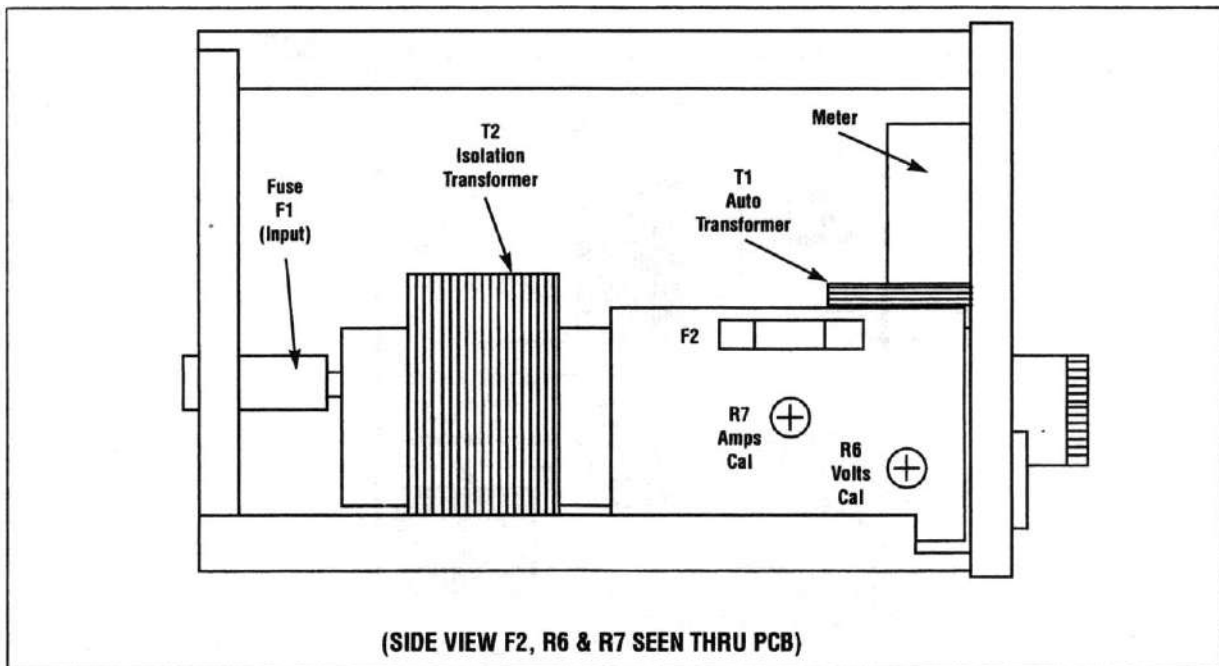

Figure 14. Location of Fuses and Calibration Adjustments, Model 1653A.

MAINTENANCE AND CALIBRATION

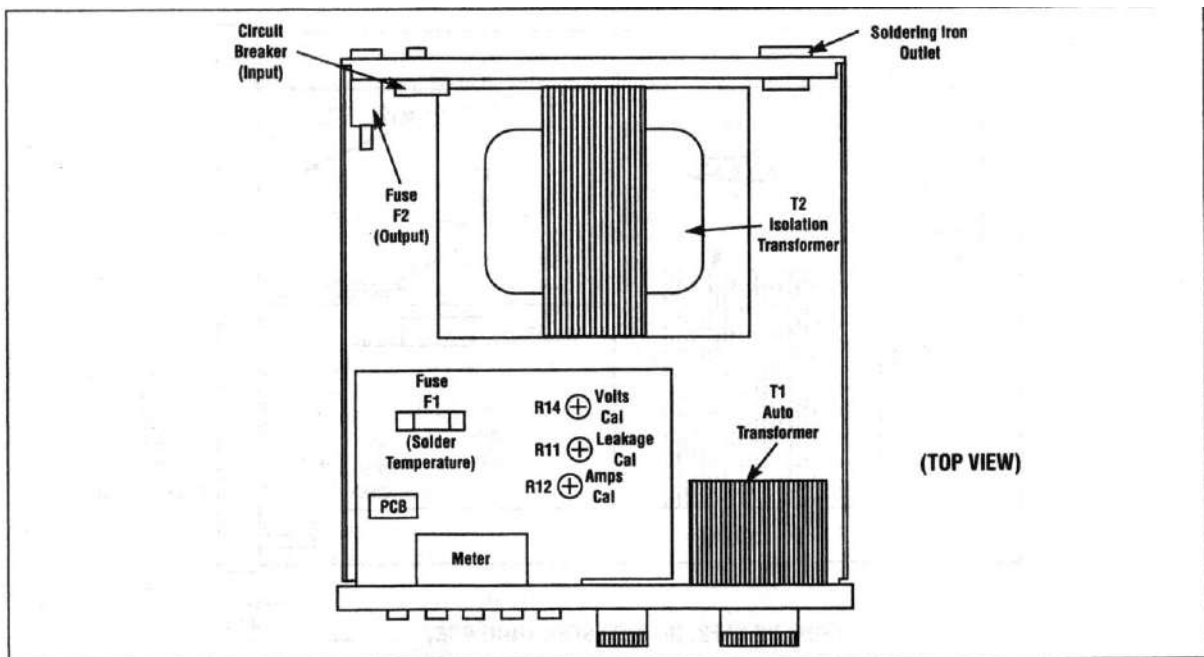

Figure 15. Location of Fuses and Calibration Adjustments, Model 1655A.

MAINTENANCE AND CALIBRATION

Meter VOLTS Calibration

1. With the power supply turned off, adjust the mechanical zero of the meter to exact zero.
2. Connect an external multimeter of $\pm 0.5\%$ or better ac voltage accuracy to the ISOLATED OUTPUT.
3. Turn on the ac power supply and set the AC VOLTS control for 120 volts on the multimeter
4. Set function switch to VOLTS and adjust VOLTS CAL (R6 for Model 1653A, R14 for Model 1655A) for 120 volts on built-in meter.

Meter AMPS Calibration

1. Connect a 60 ohm, 240 watt resistive load to the ISOLATED OUTPUT receptacle. Parallel light bulbs totaling 240 watts is suitable.
2. Connect a calibrated multimeter of 1% or better ac current accuracy in series with the load to measure each current. Set the multimeter to a 2-amp range.
3. Turn on the ac power supply and slowly increase the output voltage until the multimeter measures 2.0 amps.
4. Set the function switch to AMPS and adjust AMPS CAL (R7 for Model 1653A, R12 for Model 1655A) for 2.0 amps on the built-in meter.
5. For Model 1655A, adjust calibration on the 0-2A range. The adjustment calibrates both scales. If 0-4A range is inaccurate, replace R5 and R6 with matched equal resistors and repeat calibration adjustment.

Meter LEAKAGE Calibration (Model 1655A only)

1. Connect the leakage probe in series with a 220 k Ω , ¼ watt resistor.
2. Connect a calibrated multimeter of 1% or better ac current accuracy in series with the 220k Ω resistor and leakage probe. Set the multimeter to measure 500 μ A ac current.
3. Carefully connect the other lead of the multimeter to the hot side of the ISOLATED OUTPUT receptacle. Adjust the AC VOLTS control for exactly 500 μ A on the multimeter.
4. Select the LEAKAGE function and adjust LEAKAGE CAL (R11) for 500 μ A on the built-in meter.

PERFORMANCE TESTS

The following checks test all functions of the ac power supply for proper operation. The sequence of the checks also provides a logical symptom and fault isolation technique for troubleshooting. After troubleshooting and repair, these tests should be performed to assure that all faults have been corrected.

1. Before the power supply is turned on, the meter should rest at exact zero. If mechanical zero adjustment is required, calibration adjustments should be rechecked.
2. Set the POWER ON switch to on. The POWER ON pilot light should illuminate.
3. Set the function switch to VOLTS and rotate the AC VOLTS control to minimum (fully counterclockwise). The output should go to zero as read on the front panel meter.

MAINTENANCE AND CALIBRATION

4. Rotate the AC VOLTS control to maximum. The control should rotate smoothly and the output voltage should increase smoothly to 150 volts, as read on the meter. TO check mete calibration, measure voltage with calibrated external meter at 120 volts and compare reading to front panel meter.
5. Reduce the voltage to minimum and connect a load to the ISOLATED OUTPUT. A load consisting of light bulbs totaling 240 watts is preferred. Set the function switch to AMPS and increase the AC VOLTS control until the meter reads 2 amps (or 120 volts, whichever occurs first). To check meter calibration, measure current with calibrated external meter at 2.0 amps and compare to front panel meter.
6. For Model 1655A, check that the meter reads 2 amps on both the 0-2A and 0-4A range.
7. For Model 1655A, check the leakage function as follows:
 - a. Reduce the voltage to minimum and connect the leakage probe to the hot side of the ISOLATED OUTPUT.
 - b. Select the LEAKAGE function and slowly increase the AC VOLTS control until meter reads 500 μ A on the leakage scale. This should occur at about 6 volts. To check meter calibration, measure leakage current with calibrated external meter and compare to front panel meter.
 - c. Increase the AC VOLTS control until the meter reads 5mA on the leakage scale. This should occur at about 60 volts. With the reverse polarity of LEAKAGE function, the meter should read zero.
 - d. Change the leakage probe to the common side of the ISOLATED OUTPUT and select both polarities of the LEAKAGE function. One polarity should read zero and the other should indicate 5mA of leakage.
8. For Model 1655A, check the soldering iron temperature control function as follows:
 - a. Connect a load to the soldering iron outlet on the rear panel. A lamp of 25 to 100 watts is preferred, or a soldering iron may be used. Turn on the SOLDER TEMP control. The amber pilot light should illuminate.
 - b. Connect an ac voltmeter across the load and vary the SOLDER TEMP control from minimum to maximum. At 120 volts line voltage, the light bulb intensity should vary and the voltmeter should read from roughly 85 volts at minimum to 118 volts at maximum (this variation will not be achieved unless a load is connected).

TROUBLESHOOTING

If the previously listed "Performance Tests" are performed in the sequence listed, this provides a logical approach to defining symptoms and isolating defective circuitry. The following information may help further isolate the problem

MAINTENANCE AND CALIBRATION

No POWER ON Pilot Light

This symptom indicates either a fault in the primary power circuit, or a tripped circuit breaker (Model 1655A) or blown fuse (Model 1653A). The following checks should isolate the problem.

1. Make sure the unit is plugged into a “live” outlet.
2. Reset the circuit breaker (Model 1655A) or check the rear panel fuse and replace if burned out (Model 1653A).
3. If the circuit breaker or fuse is okay, verify whether there is any output from the supply; select VOLTS function and note meter reading on 0-150V scale. If output is available, the pilot light bulb is probably defective. If no output is noted, the trouble is probably an open in the power transformer primary circuit. Check continuity of the power cord, fuseholder, POWER ON switch, variable auto-transformer, and the wiring interconnecting these parts.
4. If circuit breaker does not trip again, or replacement fuse does not burn out when unit is turned on, previous fault may have been caused by an overload connected at the ISOLATED OUTPUT.
5. If circuit breaker trips again, or replacement fuse burns out, check for shorted variable auto-transformer or power transformer.

No Output-Pilot Light Okay

1. If no output voltage is indicated on the front panel meter, check voltage at ISOLATED OUTPUT with external ac voltmeter.

2. If no voltage is measured on external meter, check rear panel fuse (Model 1655A) or internal fuse F2 (Model 1653A) and replace if burned out. If fuse is okay, check brush of variable auto-transformer. Check for open winding in isolation transformer or open current sensing resistor.
3. If voltage is measured on external meter, but none is indicated on front panel meter, see troubleshooting procedure in next paragraph.

Incorrect or No VOLTS, AMPS, or LEAKAGE Meter Reading

1. Check meter reading in all three functions to further isolate the fault.
2. For inaccuracy, perform calibration adjustments. If no reading or inability to adjust to correct reading, a defective component is indicated.
3. If trouble appears in more than one mode, check bridge rectifier diodes, meter, and series resistors. If trouble is in one mode only, check function switch and associated metering resistors.

SOLDER TEMP Operation Abnormal (Model 1655A Only)

1. If no SOLDER TEMP pilot light, check internal fuse F1 and replace if burned out. If fuse is good, check voltage at soldering iron outlet. If voltage at outlet is okay, pilot lamp is defective.
2. If pilot light is okay, but no output voltage or incorrect output voltage, check triac TR1, breakdown diode D1, resistors R1, R2, and R3, capacitors C1, C2, and inductor L1.



Service Information

Warranty Service: Please return the product in the original packaging with proof of purchase to the address below. Clearly state in writing the performance problem and return any leads, probes, connectors and accessories that you are using with the device.

Non-Warranty Service: Return the product in the original packaging to the address below. Clearly state in writing the performance problem and return any leads, probes, connectors and accessories that you are using with the device. Customers not on open account must include payment in the form of a money order or credit card. For the most current repair charges please visit [www.bkprecision.com](#) and click on "service/repair".

Return all merchandise to B&K Precision Corp. with pre-paid shipping. The flat-rate repair charge for Non-Warranty Service does not include return shipping. Return shipping to locations in North American is included for Warranty Service. For overnight shipments and non-North American shipping fees please contact [1-800-541-7777](#).

Include with the returned instrument your complete return shipping address, contact name, phone number and description of problem.

LIMITED ONE YEAR WARRANTY

B&K Precision Corp. warrants to the original purchaser that its product and the component parts thereof, will be free from defects in workmanship and materials for a period of three years from the date of purchase.

B&K Precision Corp. will, without charge, repair or replace, at its option, defective product or component parts. Returned product must be accompanied by proof of the purchase date in the form of a sales receipt.

To obtain warranty coverage in the U.S.A., this product must be registered by completing a warranty registration form on within fifteen (15) days of purchase.

Exclusions: This warranty does not apply in the event of misuse or abuse of the product or as a result of unauthorized alternations or repairs. It is void if the serial number is alternated, defaced, or removed.

B&K Precision Corp. shall not be liable for any consequential damages, including without limitation damages resulting from loss of use. Some states do not allow limitation of incidental or consequential damages, so the above limitation or exclusion may not apply to you.

This warranty gives you specific rights and you may have other rights, which vary from state-to-state.

Model Number: _____

Date Purchased: _____