

Cable Locator Transmitter/Receiver Model 6681

User Manual
ENGLISH



Measure up



Statement of Compliance

Chauvin Arnoux®, Inc. d.b.a. AEMC® Instruments certifies that this instrument has been calibrated using standards and instruments traceable to international standards.

We guarantee that at the time of shipping your instrument has met its published specifications.

The recommended calibration interval for this instrument is 12 months and begins on the date of receipt by the customer. For recalibration, please use our calibration services. Refer to our repair and

Serial #: _____

Catalog #: 2127.85

Model #: 6681

Please fill in the appropriate date as indicated:

Date Received: _____

Date Calibration Due: _____



ORDERING INFORMATION

Ordering Information:

Cable Locator Transmitter and Receiver..... Cat. #2127.85

Shipping Contents:



(1) Cable Locator Transmitter and
(1) Cable Locator Receiver



(1) Soft Carrying Case



Set of 2, Color-coded (Red/Black) Leads (Rated 1000V CAT III)
& Alligator Clips (Rated 1000V CAT II)



(1) Mini Ground Rod



(1) Adapter - 110V
outlet w/banana plugs

Also includes (6) AAA batteries, (1) 9V battery and user manual.

Replacement Parts

Lead - Set of 2, 5 ft Color-coded (Red/Black) Leads (Rated 1000V CAT III),
& Alligator Clips (Rated 1000V CAT II) Cat. #2140.62





Mini Ground Rod Cat. #5000.79

Case – Replacement Soft Carrying Case..... Cat. #5000.81

Adapter – 110V Outlet w/4mm Banana Plugs..... Cat. #2118.49

Thank you for purchasing the Model 6681 Cable Locator Transmitter and Receiver.
For best results read this user manual carefully and follow all precautions for its use.

SYMBOLS

	Danger. Refer to this data sheet whenever this danger symbol appears.
	Indicates conformity with European directives, in particular LVD and EMC.
	Indicates that, in the European Union, the product must undergo selective disposal in compliance with Directive WEEE 2002/96/EC. This equipment must not be treated as household waste.
	Battery.
	DC and AC.

PRECAUTIONS FOR USE

	<p>This instrument and its accessories comply with safety standards IEC 61010 for voltages of 300V in category III at an altitude of less than 6562' (2000m), indoors, with a degree of pollution of not more than 2. Failure to observe the safety instructions may result in electric shock, fire, explosion, and destruction of the instrument and of the installations.</p> <p>If you use this instrument other than as specified, the protection it provides to you may be compromised.</p>
---	--

- Do not use the instrument if it appears damaged, incomplete, or poorly closed.
- Do not use the instrument on networks on which the voltage or category exceeds those specified in this manual.
- Comply with all conditions of use, including temperature, relative humidity, altitude, degree of pollution, and place of use.
- Before each use, check the condition of the insulation on the leads, housing, and accessories. Any item on which the insulation is deteriorated (even partially) must be set aside for repair or scrapping.

- Only use leads and accessories supplied. Using leads or accessories of a lower voltage or category reduces the voltage or category of the combined instrument + leads (or accessories) to that of the leads/accessories.
- All troubleshooting and metrological verifications must be done by certified personnel. Any change may compromise safety.
- Wear suitable personal protective equipment when hazardous voltages may be accessible in the installation where the measurement is made.
- Store the instrument a clean, dry, cool place. Remove the batteries before any prolonged period of non-use.



Connecting the transmitter to an installation at line voltage may create a milliamps-level current in the circuit.

In normal use, the transmitter must be connected only between phase and neutral. If the transmitter is accidentally connected between phase and ground, and there is a fault in the installation, all parts connected to ground may become live.

When used on a live installation, the instrument must first be checked to ensure installation complies with standards (NF-C-15-100, VDE-100, etc., depending on the country), in particular earth resistance and connection of the ground conductor (PE) to earth.

MEASUREMENT CATEGORIES

CAT IV: corresponds to measurements taken at the source of low-voltage installations.

Example: power feeders, counters and protection devices.

CAT III: corresponds to measurements on building installations.

Example: distribution panel, circuit-breakers, machines or fixed industrial devices.

CAT II: corresponds to measurements taken on circuits directly connected to low-voltage installations.

Example: power supply to electro-domestic devices and portable tools.

TABLE OF CONTENTS

1. INTRODUCTION	7
2. DESCRIPTION	8
2.1 TRANSMITTER.....	8
2.1.1 INTERFACE.....	8
2.1.2 LCD SCREEN.....	9
2.2 RECEIVER.....	9
2.2.1 INTERFACE.....	9
2.2.2 LCD SCREEN.....	10
2.2.3 CABLE DETECTION MODE EXAMPLES.....	10
3. OPERATION	11
3.1 GETTING STARTED.....	11
3.1.1 SETTING UP.....	11
3.1.2 USE.....	11
3.1.3 NEXT STEP: 2 TRANSMITTER CONNECTION MODES.....	12
3.2 SINGLE-POLE OPERATION.....	13
3.2.1 LOCATING AND TRACING LINES AND OUTLETS.....	13
3.2.2 LINE BREAKS LOCATION.....	14
3.2.3 LINE BREAKS LOCATION USING TWO TRANSMITTERS.....	16
3.2.4 FLOOR RADIANT HEATING SYSTEM FAULT DETECTION.....	17
3.2.6 METALLIC WATER SUPPLY AND HEATING RADIATORS DETECTION.....	19
3.2.7 IDENTIFICATION OF A BRANCH CIRCUIT ON THE SAME FLOOR.....	20
3.2.8 UNDERGROUND CIRCUIT TRACING.....	21
3.3 TWO-POLE OPERATION.....	22
3.3.1 CLOSED-CIRCUIT APPLICATIONS.....	22
3.3.2 CIRCUIT BREAKERS/FUSES DETECTION.....	23
3.3.3 SHORT-CIRCUIT DETECTION.....	24
3.3.4 DEEP UNDERGROUND CABLES DETECTION.....	25
3.3.5 SORTING OR IDENTIFICATION OF CONDUCTOR PAIRS.....	26
3.4 INCREASING THE EFFECTIVE RADIUS OF DETECTION OF LIVE CIRCUITS.....	27
3.5 LINE VOLTAGE IDENTIFICATION/SEARCHING FOR BREAKS IN THE CIRCUIT.....	28
4. ADDITIONAL FUNCTIONS	29
4.1 TRANSMITTER VOLTMETER FUNCTION.....	29
4.2 FLASHLIGHT FUNCTION.....	29
4.3 BACK-LIGHT FUNCTION.....	29
4.4 BUZZER ACTIVATION/DE-ACTIVATION.....	29
4.4.1 TRANSMITTER.....	29
4.4.2 RECEIVER.....	29
4.5 AUTOMATIC POWER-OFF FUNCTION.....	29
4.5.1 TRANSMITTER.....	29
4.5.2 RECEIVER.....	29
5. SPECIFICATIONS	30
5.1 TRANSMITTER SPECIFICATIONS.....	30
5.2 RECEIVER SPECIFICATIONS.....	30
5.3 COMPLIANCE WITH INTERNATIONAL STANDARDS.....	31
6. MAINTENANCE	32
6.1 CLEANING.....	32
6.2 BATTERY REPLACEMENT.....	32
6.3 TRANSMITTER FUSE CHECK.....	32

1. INTRODUCTION

The Cable Locator Model 6681 detects telecommunications cables, data cables, electric power supply cables, and metal pipes in installations of category III (or lower), at voltages of 300V (or less) with respect to ground.

The instrument is a portable device comprising a transmitter, receiver, and accessories. The transmitter and receiver each have a large back-lit LCD and large keys.

The transmitter applies an AC voltage modulated by digital signals to the circuit that is to be located, which creates a proportional alternating electric field. The transmitter is also an AC/DC voltmeter; the display of the measured voltage is accompanied by a symbol warning of the presence of a voltage. The transmitter also has a self-test function, indicating good transmission between transmitter and receiver.

The receiver has a sensitive sensor that generates a display proportional to the electric field detected. The variations of this signal, after decoding, processing, and shaping, enable the user to determine the location of underground cables and pipes, and the detection of any faults in them. The receiver also has a buzzer that changes pitch as a function of the strength of the signal detected.

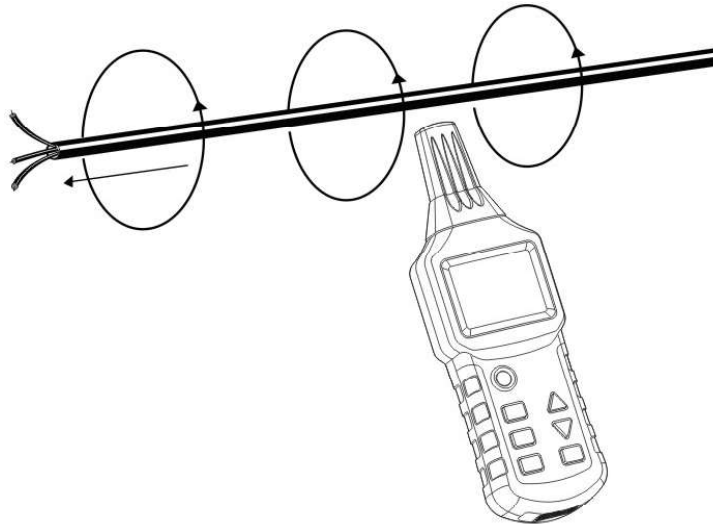

Fig. 1

2. DESCRIPTION

2.1 TRANSMITTER

2.1.1 INTERFACE

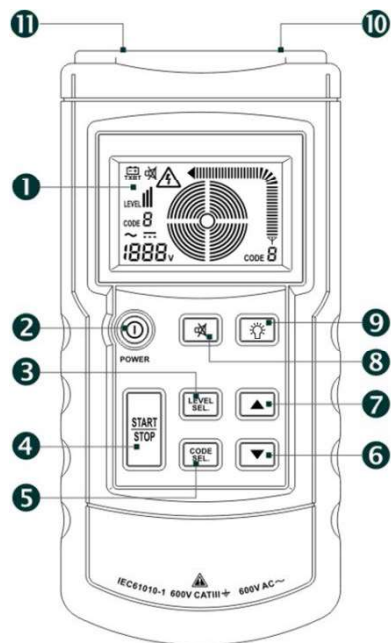

Fig. 2

1. LCD screen.
2. **POWER**: Turns instrument ON/OFF.
3. **LEVEL SEL**: Adjusts/confirms transmit power level (Level I, II or III).
4. **START/STOP**: Starts/stops transmission.
5. **CODE SEL**: Adjusts/confirms code information to be set. Press key for 1 second to activate code selection mode. Press briefly to exit from this mode. Codes F, E, H, D, L, C, Y, and A can be selected; F is the default.
6. **▼**: Decreases transmitted power level or changes the transmission code.
7. **▲**: Increases transmitted power level or changes the transmission code.
8. **🔇**: Silent mode activation/de-activation. In silent mode, key presses and the buzzer are silent.
9. **💡**: Flashlight ON/OFF.
10. "+" input/output terminal for voltage measurement and injection signal to system under test.
11. "COM" input/output terminal/Grounding terminal.

Note that if one of the **POWER**, **CODE SEL**, or **LEVEL SEL** keys is active, the other two are inactive.

2.1.2 LCD SCREEN

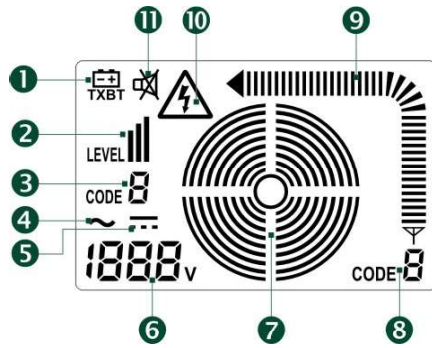

Fig. 3

1. Transmitter battery indicator.
2. Transmitted power level (Level I, II, or III).
3. Transmission code (F is default).
4. AC voltage.
5. DC voltage.
6. Measured voltage. The instrument can be used as a voltmeter with a range 12 to 300V AC/DC.
7. Transmission status.
8. Code transmitted.
9. Transmitted signal strength.
10. Voltage present symbol.
11. Silent mode symbol.

2.2 RECEIVER

2.2.1 INTERFACE

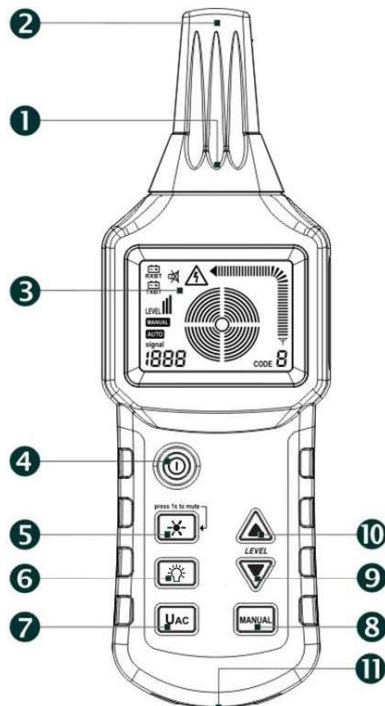

Fig. 4

1. Flashlight indication.
2. Sensor head.
3. LCD screen.
4. : Turns instrument ON/OFF.
5. : Backlighting and silent mode ON/OFF. Press briefly to activate/de-activate backlighting. Press for 1 second to activate/de-activate silent mode. In silent mode, key presses and the buzzer are silent.
6. : Flashlight ON/OFF.
7. **UAC**: Cable detection mode or Line voltage detection mode.
8. **MANUAL**: Manual or automatic cable detection mode.
9. : Decrease received sensitivity in manual mode.
10. : Increase received sensitivity in manual mode.
11. Buzzer.

2.2.2 LCD SCREEN

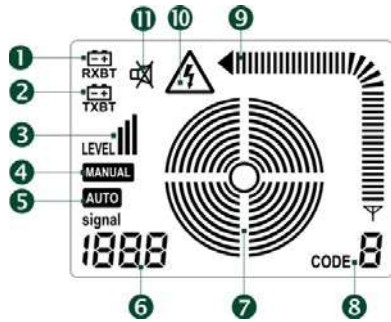

Fig. 5

1. Receiver battery indicator.
2. Transmitter battery indicator.
3. Received signal level (Level I, II, or III).
4. Manual mode indicator.
5. Automatic mode indicator.
6. Signal strength indicator in automatic mode. In manual mode, displays either "SEL" (to indicate that there is no signal) or a value indicating signal strength. In AC mode, "UAC" is displayed.
7. Concentric circles indicating the preset sensitivity in graphic form. A large number of circles indicates high sensitivity. A small number indicates lower sensitivity.
8. Code received.
9. Received signal strength.
10. Voltage present indicator.
11. Silent mode indicator.

2.2.3 CABLE DETECTION MODE EXAMPLES

1. Automatic mode

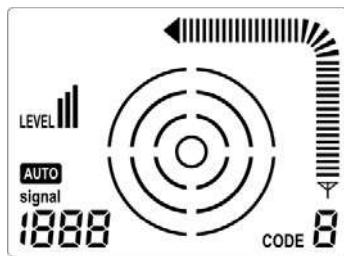

Fig. 6

2. Manual mode

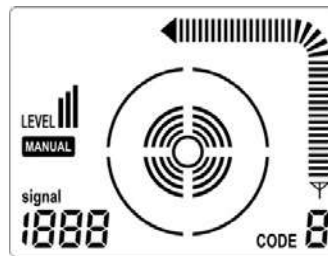

Fig. 7

3. Mains voltage identification mode

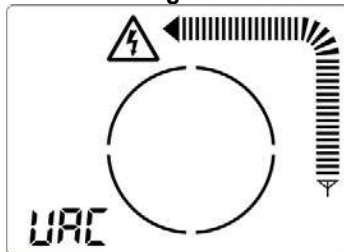

Fig. 8

3. OPERATION

3.1 GETTING STARTED

The best way to learn to use the Model 6681 cable locator is to follow the example below:

3.1.1 SETTING UP

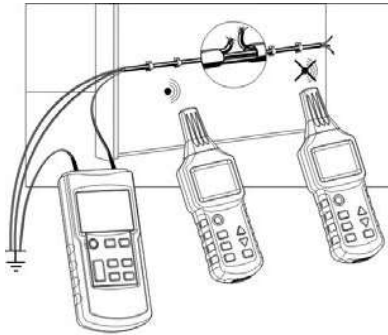

Fig. 9

1. Obtain a length of sheathed 3-conductor cable with a cross section of at least 0.0625".
2. Temporarily staple a 15' length of this cable along a wall, on an attachment surface at eye level. The wall must be accessible from both sides.
3. Create an artificial break in one of the conductors at approximately 5' from one end.
4. Connect the end of the broken cable to the (+) terminal on the transmitter using the test leads (provided).
5. Connect the COM terminal of the transmitter to ground. All other conductors of the cable must also be connected to the transmitter and to the same ground (see Fig. 9).

At the far end of the cable, the conductors must be "open" (not connected to each other).

3.1.2 USE

1. Switch the transmitter ON using the ON/OFF key. The transmitter displays the initial screen and the buzzer beeps twice.
2. Press LEVEL SEL on the transmitter to enter transmit level adjustment, then use the up and down arrow keys to select the transmit level (I, II, or III). After setting this level, press LEVEL SEL again to exit.
3. To change the code transmitted, press the CODE SEL key on the transmitter for approximately 1 second, then press the up arrow key or the down arrow key to select the code transmitted (F, E, H, D, L, C, Y, or A; F is default). Press the CODE SEL key again to exit.
4. Press START/STOP to start transmission. The concentric circles displayed on the LCD screen will spread gradually, the code of the transmitted signal appears on the lower right side of the display, and the strength is graphically displayed (see Fig 5).

5. Press the ON/OFF key on the receiver to turn it on. The LCD displays the start screen, the buzzer beeps twice, and the receiver changes to Automatic Mode as default.
6. Move the probe of the receiver slowly along the cable up to the break. A bar graph on the right side on the receiver displays the received power level, the code transmitted by the transmitter appears on the bottom right, the dynamic signal strength is graphically displayed, and the buzzer changes pitch with the change of signal strength. When the receiver probe passes over the break, the strength of the displayed signal exhibits an obvious drop, and then disappears completely.
7. To refine the detection, press the MANUAL key on the receiver to change to manual mode, then use the down arrow key to reduce the sensitivity as far as possible while checking that the receiver screen can display the transmit code from the transmitter. This identifies where the break is located.

3.1.3 NEXT STEP: 2 TRANSMITTER CONNECTION MODES

Only these transmitter connection modes can be used to locate conductors with the Model 6681 Cable Locator.

Single-pole application

Connect the transmitter to a single conductor. If the signal transmitted by the transmitter is a high-frequency signal, only one conductor can be detected and traced.

The second conductor is then grounded.

This arrangement causes the flow of a high-frequency current in the conductor and its transmission through the air to ground; this is the same principle used between the transmitter and the receiver for radio broadcasting.

Two-pole application

This connection can be made energized or de-energized AC lines. The transmitter is connected to both conductors using the two test leads.

Connection to an energized cable:

1. Connect the "+" terminal of the transmitter to the conductor connected to the phase.
2. Connect the COM terminal of the transmitter to the neutral wire. In this case, if there is no load on the line, the modulated current from the transmitter will flow to the neutral conductor by coupling via the distributed capacitance of the wires, and then return to the transmitter.

NOTE: When the transmitter is connected to a live line, if one of its terminals is connected to a ground wire rather than the neutral, the current through the transmitter is added to the leakage current already present in the installation. The resulting total leakage current may then activate a GFCI if it is in that branch and possibly trip it.

Connection to a de-energized cable:

1. Connect the "+" terminal of the transmitter to one wire of the cable.
2. Connect the other terminal of the transmitter to the other wire of the cable.
3. At the other end of the cable, connect the two wires together.

In this case, the modulated current returns directly to the transmitter through the cable.

In another method, the two test leads of the transmitter can be connected to the two ends of a single wire. In addition, since the installation is dead, the ground conductor of the line can also be used without risk.

3.2 SINGLE-POLE OPERATION

To detect breaks in conductors in walls or under a floor:

1. Locate and trace wires, outlets, junction boxes, switches, etc., in domestic installations.
2. Locate bottlenecks, twists, deformations, and obstructions in piping installations using a metal wire.

3.2.1 LOCATING AND TRACING LINES AND OUTLETS

Preconditions:

- The circuit must be de-energized.
- The neutral wire and the ground wire must be connected and operational.
- Connect the transmitter to the phase and to the ground wire as shown in Fig. 10.

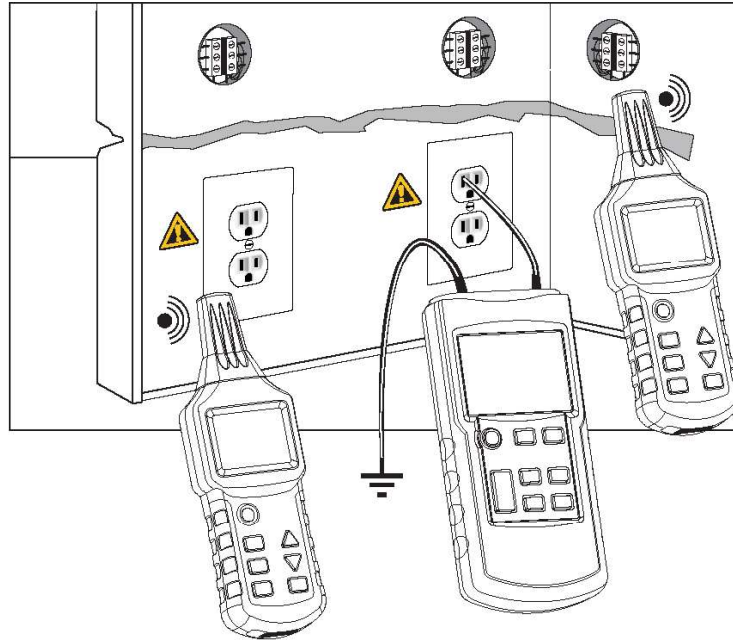

Fig. 10

NOTE: If the cable supplied by the signals from the transmitter is near other conductors that are parallel to it (examples: cable tray, channel, etc.) or is interlaced with or crosses them, the signal may then propagate in these cables and create false detection.

3.2.2 LINE BREAKS LOCATION

Preconditions:

- The circuit must be de-energized.
- All the other wires must be grounded as shown in Fig. 11.
- Connect the transmitter to the wire under test and to ground as shown in Fig. 11.

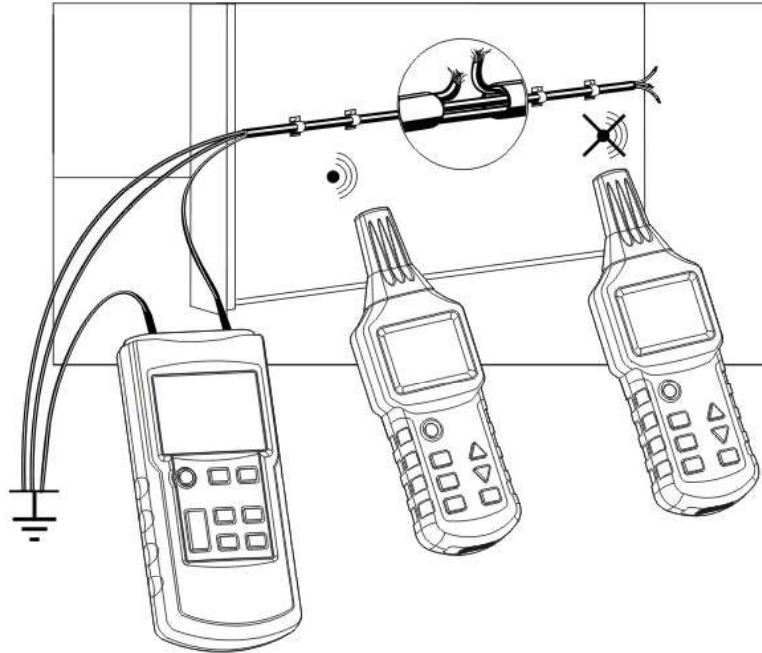

Fig. 11

NOTES:

- The transition resistance of the break in the line must be greater than 10kΩ.
- When breaks in multi-conductor cables are traced, all the other wires of the cable or of the shielded conductor must be grounded. This prevents cross coupling of the applied signals (by a capacitive effect) on the terminals of the source.
- The ground connected to the transmitter can be an auxiliary ground, the grounding terminal of a power outlet, or a properly grounded water pipe.
- Refine the detection by setting the power level transmitted by the transmitter and the sensitivity of the receiver in manual mode.
- When the wire is traced, the place at which the signal received by the receiver falls off suddenly is the location of the break.

3.2.3 LINE BREAKS LOCATION USING TWO TRANSMITTERS

When a line break is located using a transmitter supplying one end of the conductor, its location may not be precise if conditions are unsatisfactory because of a disturbance of the field. These issues can be avoided by using two transmitters (one at each end) to detect line breaks. In this case, each transmitter is set to a different line code, e.g. one transmitter to code F and the other to code C. (The second transmitter, with a different line code, must therefore be purchased separately.)

Preconditions:

- The circuit measured must not be energized.
- All unused lines must be grounded as shown in Fig. 12.
- Connect the two transmitters as shown in Fig. 12.
- The measurement method is identical to that used in §3.1.

If the transmitters are connected as shown in Fig. 12, the receiver will indicate C to the left of the line break. If the receiver goes beyond the location of the break, to the right, it will display F. If the receiver is placed right on the break, no line code will be displayed, because of the superposition of the signals from the two transmitters.

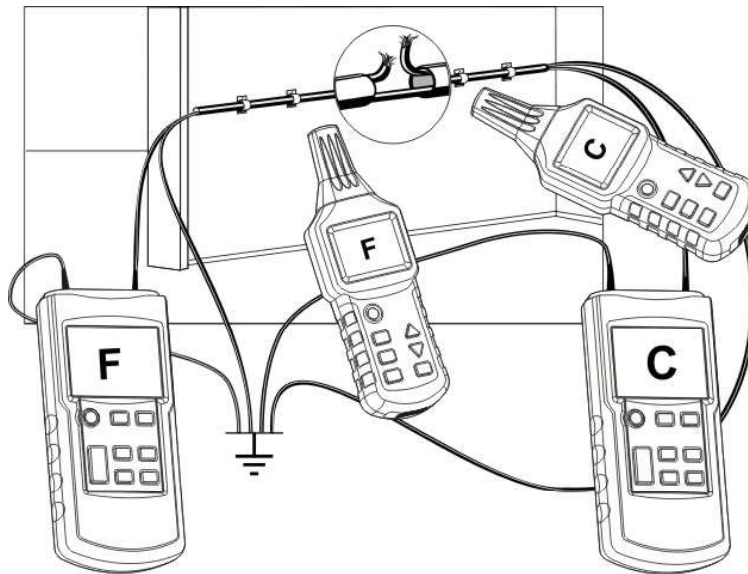

Fig. 12

NOTES:

- The transition resistance of the line break must be greater than 100k Ω .
- When breaks in multi-conductor cables are traced, all the other wires of the cable or of the shielded conductor must be grounded. This is necessary to prevent cross coupling of the applied signals (by a capacitive effect) on the terminals of the source.
- The ground connected to the transmitter can be an auxiliary ground, using the grounding terminal of a power outlet, a properly grounded water pipe, or the mini ground rod supplied with the Model 6681.
- When the line is traced, the place at which the signal received by the receiver falls off suddenly is the location of the break.

Refine the detection by setting the power level transmitted by the transmitter and the sensitivity of the receiver in manual mode.

3.2.4 FLOOR RADIANT HEATING SYSTEM FAULT DETECTION

Preconditions:

- The circuit measured must be de-energized.
- All unused lines must be grounded as shown in Fig. 13a.
- Connect the two transmitters (if two transmitters are used) as shown in Fig. 13b.
- The measurement method is identical to that used in §3.1.

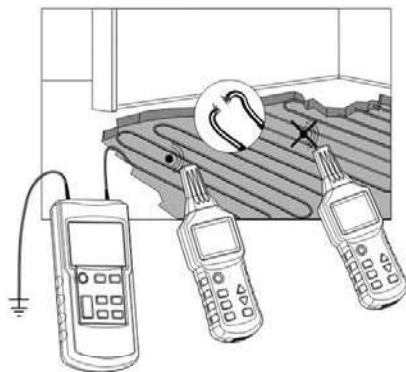

Fig. 13a

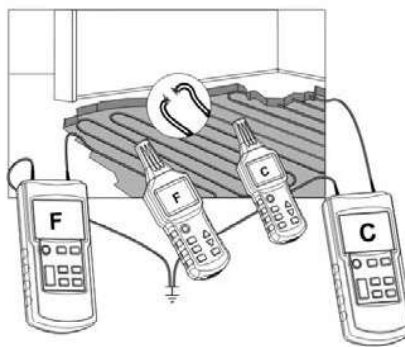

Fig. 13b

- If there is a screen above the heating wires, there may not be a ground connection. If necessary, separate the shielding from the ground connection.
- There must be grounding, and there must be a long distance between the grounding terminal of the transmitter and the line to be located. If this distance is too short, the signal and the line cannot be located precisely.

- A second transmitter is not essential for this application. (For an application with only one transmitter, refer to Fig. 13a.)
- When the line is traced, the place at which the signal received by the receiver falls off suddenly is the location of the break.

Refine the detection by setting the power level transmitted by the transmitter and the sensitivity of the receiver in manual mode.

3.2.5 CONSTRICTED (PLUGGED) SECTION OF A NON-METALLIC PIPE DETECTION

Preconditions:

- The pipe must be made of a non-conducting material (such as plastic).
- The pipe must not be energized.
- The transmitter is connected to a metallic helical tube (flexible metallic tube or pipe) and to an auxiliary ground as shown in Fig. 14.
- The measurement method is identical to that used in §3.1.

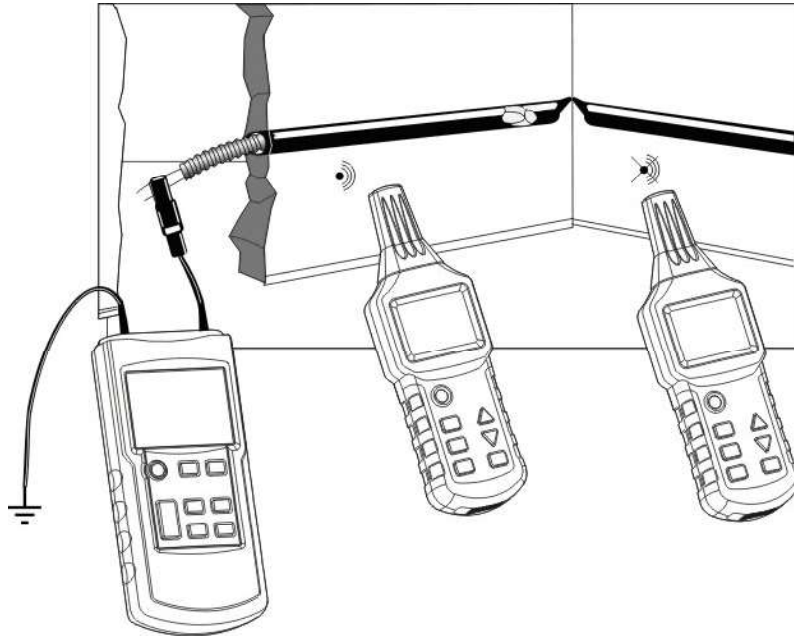

Fig. 14

NOTES:

- If there is a current flowing in the pipe, turn off its supply and connect it to ground when the pipe is de-energized.
- One end of the pipe must be grounded, and the ground of the transmitter must be at a safe distance from the pipe to be located. If the estimated distance is too short, the signal and the circuit cannot be located precisely.
- If you have only a helical pipe made of a non-conducting material (fiberglass, PVC, etc.), we suggest inserting a metal wire having a cross section of approximately 0.0625" in the non-conducting helical pipe.
- When the line is traced, the place at which the signal received by the receiver falls off suddenly is the location of the constriction.
- Refine the detection by setting the power level transmitted by the transmitter and the sensitivity of the receiver in manual mode.

3.2.6 METALLIC WATER SUPPLY AND HEATING RADIATORS DETECTION

Preconditions:

- The pipe to be detected must be conductive and metallic (for example galvanized steel).
- The pipe must not be grounded. There must be a relatively high resistance between the pipe and the ground (otherwise, the detection distance will be too short).
- Connect the transmitter to the pipe and to ground.

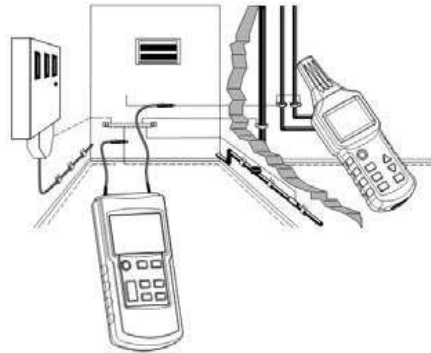

Fig. 15

NOTES:

- The transmitter must be grounded at a safe distance from the pipe to be detected. If the distance is too short, the signals and the circuit cannot be located precisely.

- To detect a pipe made of a non-conducting material, we suggest first inserting a helical metal tube or a metal wire having a cross section of approximately 0.625" in the pipe, as explained in §3.2.5.
- Refine the detection by setting the power level transmitted by the transmitter and the sensitivity of the receiver in manual mode.

3.2.7 IDENTIFICATION OF A BRANCH CIRCUIT ON THE SAME FLOOR

Precondition: The circuit measured must de-energized.

To detect a supply circuit on the same floor, proceed as follows:

1. Trip the main circuit-breaker of the floor's load center (circuit breaker panel).
2. In the circuit breaker panel, disconnect the neutral wire of the circuit to be identified from the neutral wires of the other circuits.
3. Connect the transmitter as shown in Figure 16.

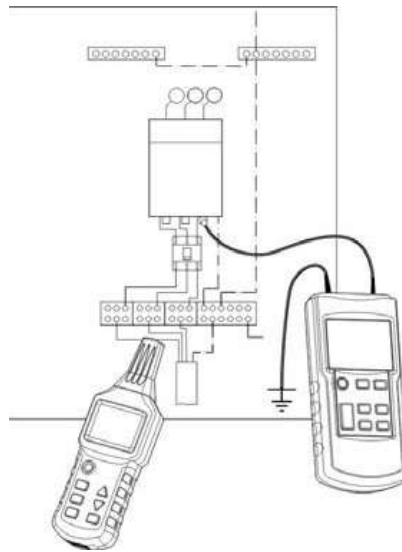

Fig. 16

NOTE: Refine the detection by setting the power level transmitted by the transmitter and the sensitivity of the receiver in manual mode.

3.2.8 UNDERGROUND CIRCUIT TRACING

Preconditions:

- The circuit measured must be de-energized.
- The transmitter must be connected to ground.

Then proceed as follows:

1. Connect the transmitter as shown in Figure 17.
2. Select the automatic mode of the receiver.
3. Use the power of the signal displayed to find and trace the circuit.

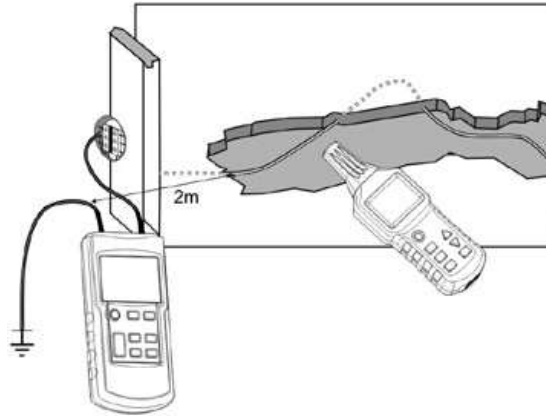

Fig. 17

NOTES:

- The distance between the ground wire and the circuit to be located must be as long as possible. If this distance is too short, the signals and the circuit cannot be located precisely.
- The depth of detection is strongly influenced by the conditions of the earth. Select suitable receive sensitivities to locate the circuit precisely.
- If you move the receiver slowly along the circuit to be located, you will see that the screen changes somewhat. The most powerful signals represent the precise position of the circuit.
- The longer the distance between the signals transmitted (by the transmitter) and the receiver, the lower the power of the signals received and the lower the depth of detection possible.

3.3 TWO-POLE OPERATION

3.3.1 CLOSED-CIRCUIT APPLICATIONS

These can be applied to both energized and de-energized circuits:

- In de-energized circuits, the transmitter only sends coded signals to the circuits to be detected.
- In energized circuits, the transmitter sends coded signals to the circuits to be detected, and also measures the voltage present, as shown in Figure 18:

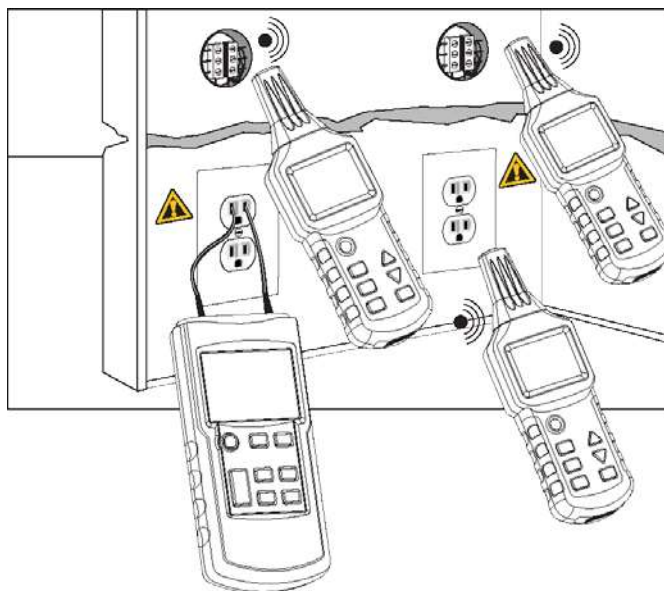

Fig. 18

NOTES:

- This method is ideal for locating outlets, switches, circuit breakers, fuses, etc., in electrical installations that have sub-distribution electrical cabinets.
- The depth of detection varies according to the medium in which the cable is located and according to the manner of use. It is generally less than 1.5'.
- Adjust the power transmitted by the transmitter according to the various radii of detection.

3.3.2 CIRCUIT BREAKERS/FUSES DETECTION

The transmitter is connected to the phase and neutral conductors of the circuit of which the protection fuse is to be located.

1. Trip all the circuit-breakers in the distribution box.
2. Connect the transmitter as shown in Figure 19.

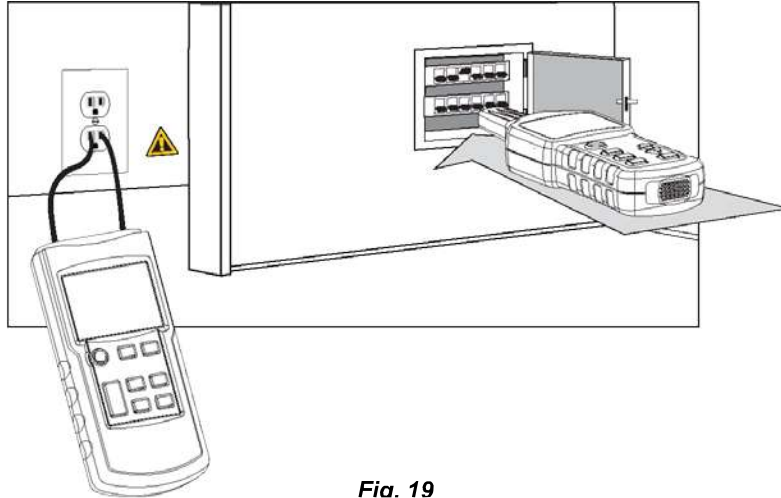

Fig. 19

NOTES:

- The identification and location of the circuit breakers are strongly influenced by the condition of the wiring of the distribution frame. To locate circuit breakers or fuses as precisely as possible, it may be necessary to open or remove the cover of the distribution panel to isolate the branch supply wire.
- During the search process, the circuit breaker or fuse with the strongest and most stable signals is the one associated with the branch outlet that the transmitter is connected to. Because of the coupling of the connections, the detector can detect signals from other circuit breakers or fuses, but their power is relatively low.
- During the detection, it is best to place the probe of the detector on the input of the circuit breaker or fuse connection to obtain the best result.
- Adjust the power transmitted by the transmitter according to the various radii of detection.
- Select manual mode on the receiver and a suitable receive sensitivity to locate the circuit precisely.

3.3.3 SHORT-CIRCUIT DETECTION

Precondition: The circuit must be de-energized.

1. Connect the transmitter as shown in figure 20.
2. The measurement method is identical to that used in §3.1.

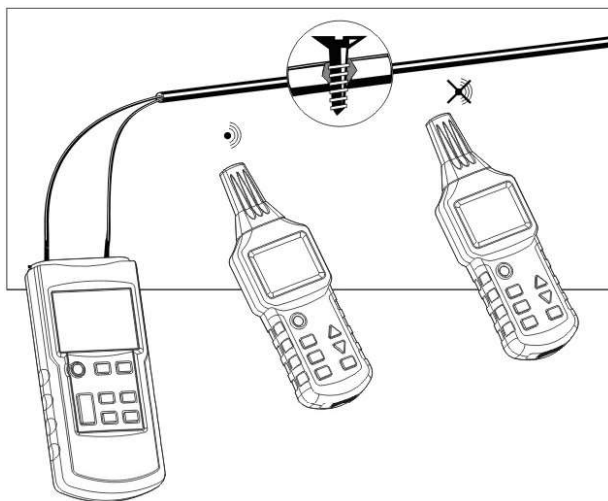

Fig. 20

NOTES:

- During searches for short-circuits in sheathed wires and cables, the depth of detection vary because the wires are twisted together in the sheath. Only short-circuits with an impedance less than 20Ω can be detected correctly. The impedance of the short-circuit can be measured with a multimeter.
- During the detection process along the circuit, if the signals received are suddenly attenuated, the position detected is where the short-circuit is located.
- If the impedance of the short-circuit is greater than 20Ω , try using the method of searching for a break in a circuit (see §3.2.2) to find the court-circuit.

3.3.4 DEEP UNDERGROUND CABLES DETECTION

The magnetic field produced by the signal from the transmitter is strongly conditioned by the shape and size (area) of the loop formed by the "forward" conductor (connected to the "+" terminal of the transmitter) and the "return" conductor (connected to the COM terminal of the transmitter).

For this reason, the depth of detection is severely limited in two-pole applications on a small multi-conductor cable. Since the two conductors are very close together, the area of the loop is often insufficient. In this case, it is best to use an "auxiliary" conductor, not one of the conductors of the multi-conductor cable, for the return path.

The important point is that the distance between the conductor connected to the + terminal and the "return" conductor connected to the COM terminal should be greater than the depth underground, and in practice this distance is routinely at least 6'.

Precondition: The circuit must be de-energized.

1. Connect the transmitter as shown in Fig. 21. The distance between the supply line and the loopback line must be at least 6 to 7.5'.
2. The measurement method is identical to that used in §3.1.

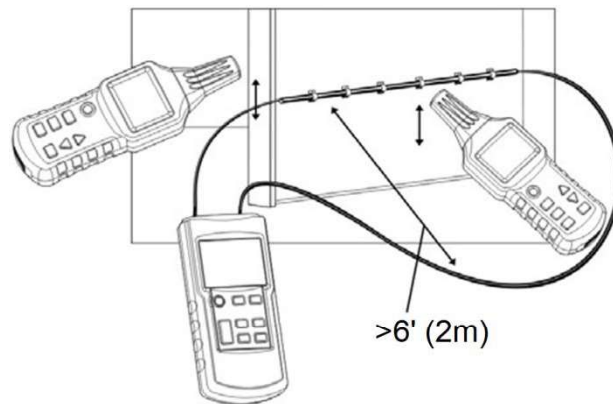

Fig. 21

NOTE: In this application, the influence of the moisture in the floor or wall on the depth of detection is negligible.

3.3.5 SORTING OR IDENTIFICATION OF CONDUCTOR PAIRS

Preconditions:

- The circuit must be de-energized.
 - The ends of the wires of each pair must be twisted together and be equally conducting; each pair remains insulated from the others.
1. Connect the transmitter as shown in Fig. 22.
 2. The measurement method is the same as in the example.

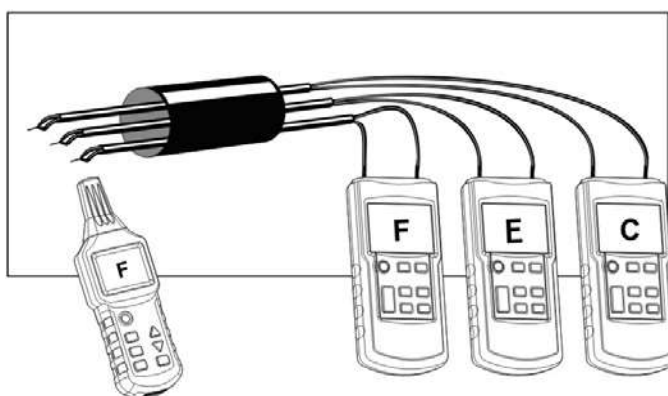

Fig. 22

NOTES:

- The ends of each pair must be twisted together to ensure correct continuity.
- When several transmitters are used, each transmitter must be set to a different transmission code.
- If only one transmitter is used, make several measurements with different connections between the transmitter and the various pairs.

3.4 INCREASING THE EFFECTIVE RADIUS OF DETECTION OF LIVE CIRCUITS

The magnetic field produced by the signal from the transmitter is strongly conditioned by the shape and size (area) of the loop formed by the conductor connected to the "+" of the transmitter and the "return" conductor connected to the "COM" terminal of the transmitter. Consequently, in a configuration where the transmitter is connected to the phase and neutral conductors, constituted by two parallel wires (as shown in Fig. 23), the effective radius (distance) of detection is not more than 1.5'.

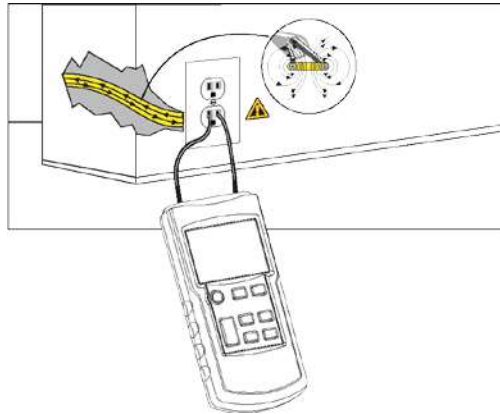

Fig. 23

To eliminate this effect, connect as shown in Fig. 24, where the loopback line uses a separate cable to increase the effective radius of detection. With a cable extender (see Fig. 24), it is possible to obtain a detection distance of up to 7.45'.

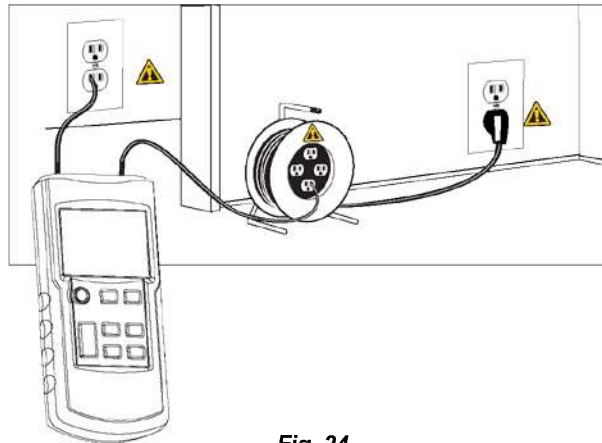

Fig. 24

3.5 LINE VOLTAGE IDENTIFICATION/SEARCHING FOR BREAKS IN THE CIRCUIT

This application does not need the transmitter (unless you want to use its voltmeter function to measure the voltage in the circuit precisely).

Preconditions:

- The circuit must be connected to an energized line.
- The measurement must be made as shown in Fig. 25.

Set the receiver to the "Identification of line voltage" mode (designated "UAC mode").

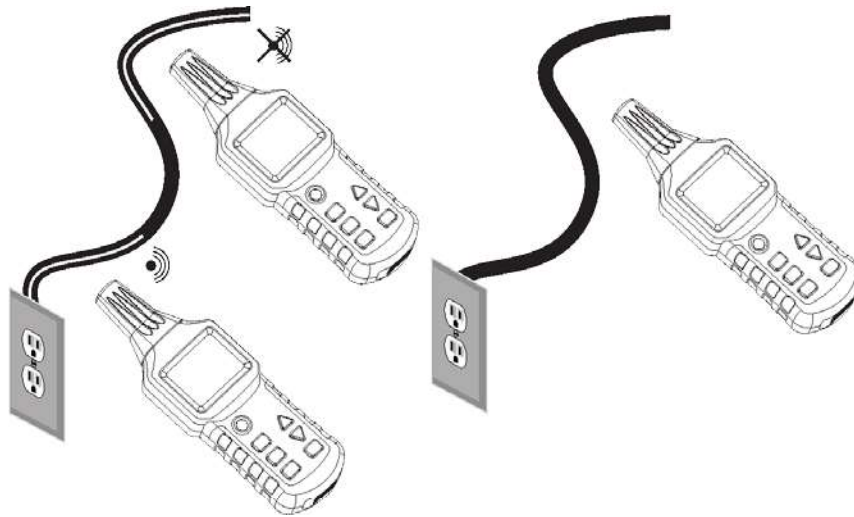

Fig. 25

NOTES:

- The AC signals detected by the receiver in UAC mode indicate only that the circuit is energized. For a precise measurement of the voltage, use the voltmeter function of the transmitter.
- During the search for the ends of several supply lines, the lines must be connected separately, one at a time.
- The number of bars indicating the strength of the received signal and the frequency of the audible signal emitted depend on the voltage in the circuit to be detected and on the distance from this circuit. The higher the voltage and the shorter the distance from the circuit, the more bars are displayed and the higher the frequency of the audible signal.

4. ADDITIONAL FUNCTIONS

4.1 TRANSMITTER VOLTMETER FUNCTION

If the transmitter is connected to an energized circuit and the voltage measured is greater than 12V, the actual voltage will be displayed on the bottom left side of the screen with AC or DC indication, and the danger triangle is displayed in the upper part of the screen (see §2.1.1). The measurement range is 12 to 300V, DC or AC (50/60Hz).

4.2 FLASHLIGHT FUNCTION



Press the flashlight button  on the transmitter or on the receiver to activate the flashlight; press it again to de-activate the function.

4.3 BACK-LIGHT FUNCTION



Press the back-light button  on the receiver to turn the back-light on; press the button again to turn it off. The transmitter does not have a back-light function.

4.4 BUZZER ACTIVATION/DE-ACTIVATION

4.4.1 TRANSMITTER

Press the silent mode button  on the transmitter to de-activate the buzzer. In this mode, key presses are silent. Press  again to reactivate the buzzer.

4.4.2 RECEIVER

Press the back-light/silent mode button  on the receiver for longer than one second to de-activate the audible signal. Press  for one second to re-activate the audible signal.

4.5 AUTOMATIC POWER-OFF FUNCTION

4.5.1 TRANSMITTER

The transmitter does not have an automatic power-off function.

4.5.2 RECEIVER

If you have not pressed a button on the receiver within 10 minutes, the receiver automatically powers OFF. Press the ON/OFF key to turn it back ON.

5. SPECIFICATIONS

5.1 TRANSMITTER SPECIFICATIONS

Output Signal Frequency	125kHz
Voltage Measurement Range	12 to 300V _{DC} ± 2.5%; 12 to 300V _{AC} (50/60Hz) ± 2.5%
Display	LCD with display of functions and bar graph
Electrical Safety	300V CAT III; Pollution class 2
Power Supply	One 9V battery, IEC 6LR61
Power Consumption	Between approximately 31mA and 115mA depending on use
Fuse	F 0.5A 500V, 0.25 × 1.26" (6.3 × 32mm)
Operating Temperature Range	32° to 104°F (0° to 40°C) with a maximum relative humidity of 80% (without condensation)
Storage Temperature	-4° to 140°F (-20° to +60°C) with a maximum relative humidity of 80% (without condensation)
Altitude	6562 ft (2000m) max
Dimensions (H × W × D)	7.48 × 3.5 × 1.67" (190 × 89 × 42.5mm)
Weight	Approximately 12 oz (360g) without battery Approximately 15 oz (420g) with battery

5.2 RECEIVER SPECIFICATIONS

Depth of Detection	Single-pole application: 0 to approximately 6.6' (2m) Two-pole application: 0 to approximately 19.7" (0.5m) Single loopback line: up to 8.2' (2.5m)
Identification of Line Voltage	Approximately 0 to 15.7" (0.4m)
Display	LCD, with display of functions and bar graph
Power Supply	Six 1.5V batteries, IEC LR03
Consumption	Between approximately 32mA and 89mA depending on use
Operating Temperature Range	32° to 104°F (0° to 40°C) with a maximum relative humidity of 80% (without condensation)
Storage Temperature	-4° to 140°F (-20° to +60°C) with a maximum relative humidity of 80% (without condensation)
Altitude	6562ft (2000m) max.
Dimensions (H × W × D)	9.5 × 3.07 × 1.52" (241.5 × 78 × 38.5mm)
Weight	Approximately 9.8 oz (280g) without battery Approximately 12 oz (360g) with battery

NOTE: The depth of detection also depends on the material and the specific application.

5.3 COMPLIANCE WITH INTERNATIONAL STANDARDS

Electrical Safety	Compliant with standards EN 61010-1
Electromagnetic Compatibility	Compliant with standard EN 61326-1

6. MAINTENANCE



Other than the fuse and batteries, the instrument contains no parts that can be replaced by a person who is not trained and certified. Any non-certified work, or parts replacement using unapproved components, may gravely impair safety.

6.1 CLEANING

Wipe the instrument with a cloth dampened with clean water or neutral detergent, then wipe dry with a cloth. Do not use the instrument until it is completely dry.

6.2 BATTERY REPLACEMENT

If the battery symbol  on the LCD blinks (on the transmitter or on the receiver) and the buzzer emits a warning, the battery(ies) must be replaced (one battery for transmitter, six for receiver). The following steps apply to both the transmitter and the receiver:

1. Switch the instrument OFF and disconnect it from all circuits being measured.
2. Remove the screw on the back of the instrument and remove the battery compartment cover.
3. Remove the old battery(ies).
4. Install the new battery(ies); observing polarity.
5. Replace the battery compartment cover and screw it back in.

6.3 TRANSMITTER FUSE CHECK

The transmitter fuse (F 0.5A 500V, 0.25 × 1.26" (6.3 × 32mm)) protects the instrument from overloads and operator errors. If the fuse is blown, the transmitter can only transmit weak signals. If the transmitter self-test is OK and the transmitted signal is weak, the fuse has blown. If no signal is transmitted during the self-test, and battery voltage is normal, the transmitter is damaged and must be repaired by an authorized technician. To check the transmitter fuse:

1. Disconnect all circuits from the transmitter.
2. Turn ON the transmitter and set it to transmit mode.
3. Set **LEVEL SEL** to Level I.
4. Connect a test lead between the two transmitted terminals.
5. Switch the receiver ON to search for the signals from the test lead, and move the receiver probe towards the test lead.
6. If the fuse is good, the value displayed by the receiver will double.

If the fuse is blown, replace it with a fuse of the same specifications. This fuse is a fast-blow type. Do not replace it with a slow-blow or wire type, because this could jeopardize the safety of the instrument.

WARRANTY REPAIRS

What you must do to return an instrument for Warranty Repair:

First, request a Customer Service Authorization Number (CSA#) by phone or by fax from our Service Department (see address below), then return the instrument along with the signed CSA Form. Please write the CSA# on the outside of the shipping container. Return the instrument, postage or shipment pre-paid to:

Ship To:

CAUTION: To protect yourself against in-transit loss, we recommend you insure your returned material.

NOTE: You must obtain a CSA# before returning any instrument.