

6471



DIGITAL GROUND RESISTANCE AND SOIL RESISTIVITY TESTER

Measure Up
WITH AEMC[®] INSTRUMENTS



Statement of Compliance

Chauvin Arnoux®, Inc. d.b.a. AEMC® Instruments certifies that this instrument has been calibrated using standards and instruments traceable to international standards.

We guarantee that at the time of shipping your instrument has met its published specifications.

An NIST traceable certificate may be requested at the time of purchase, or obtained by returning the instrument to our repair and calibration facility, for a nominal charge.

The recommended calibration interval for this instrument is 12 months and begins on the date of receipt by the customer. For recalibration, please use our calibration services. Refer to our repair and calibration section at .

Serial #: _____

Catalog #: 2135.48, 2135.49, 2135.50,
2135.60 & 2135.61

Model #: 6471

Please fill in the appropriate date as indicated:

Date Received: _____

Date Calibration Due: _____





READ CAREFULLY BEFORE USING FOR THE FIRST TIME

Your instrument is equipped with a NiMH battery. This technology offers several advantages:

- **Long battery charge life for a limited volume and weight.**
- **Possibility of quickly recharging your battery.**
- **Significantly reduced memory effect: you can recharge your battery even if it is not fully discharged.**
- **Respect for the environment: no pollutant materials such as lead or cadmium, in compliance with the applicable regulations.**

After prolonged storage, the battery may be completely discharged. If so, it must be completely recharged.

Your instrument may not function during part of this recharging operation.

Full recharging of a completely discharged battery may take several hours.



NOTE: In this case, at least 5 charge/discharge cycles will be necessary for your battery to recover 95% of its capacity.

To make the best possible use of your battery and extend its effective service life:

- **Only use the charger supplied with your instrument. Use of another charger may be dangerous.**
- **Only charge your instrument at temperatures between 0° and 40°C.**
- **Comply with the conditions of use defined in the operating manual.**
- **Comply with the storage conditions specified in the operating manual.**

NiMH technology allows a limited number of charge/discharge cycles depending significantly on:

- **The conditions of use.**
- **The charging conditions.**



Please refer to § 9.5 for correct replacement of the battery.



Do not dispose of the battery pack with other solid waste. Used batteries must be entrusted to a qualified recycling company or to a company specialized in processing hazardous materials.

Table of Contents

1. INTRODUCTION.....	6
1.1 International Electrical Symbols.....	7
1.2 Definition of Measurement Categories.....	7
1.3 Receiving Your Shipment.....	7
1.4 Ordering Information.....	8
1.4.1 Kits, Accessories and Replacement Parts.....	8
2. PRODUCT FEATURES.....	10
2.1 Description.....	10
2.2 Key Features.....	11
2.3 Control Features.....	12
2.4 Display.....	13
2.5 Button Functions.....	15
3. SPECIFICATIONS.....	16
3.1 Reference Conditions.....	16
3.2 Electrical.....	16
3.2.1 Frequency Measurements.....	16
3.2.2 Voltage Measurements.....	16
3.2.3 Current Measurements.....	17
3.2.4 DC Resistance Measurements.....	18
3.2.5 AC Earth/Ground Resistance Measurements.....	19
3.2.6 Soil Resistivity Measurement ρ	21
3.2.7 Earth/Ground Measurements with 2 Clamps.....	22
3.3 Data Storage.....	22
3.4 Power.....	23
3.5 Mechanical.....	23
3.6 Environmental.....	24
3.7 Safety.....	24
4. OPERATION.....	25
4.1 General Operating Instructions.....	25
4.1.1 Automatic Mode.....	25
4.1.2 Manual (Expert) Mode.....	25
4.2 Instrument Configuration (SET-UP mode).....	26

5. AUTOMATIC MODE.....	27
5.1 Switching the Test Voltage	27
5.2 Resistance Measurement m Ω (2-Wire).....	27
5.2.1 Lead Compensation Measurement	28
5.2.2 Alarm Function.....	29
5.3 Resistance Measurement m Ω (4-Wire).....	30
5.4 Earth/Ground Measurement (3-Pole).....	31
5.4.1 62% Method.....	31
5.4.2 Full Method	33
5.4.3 Recommendations for a Reliable Measurement.....	34
5.5 Earth/Ground Measurement (4-Pole).....	35
5.5.1 Measurement without a Clamp	35
5.5.2 Measurements with a Clamp	36
5.6 Soil Resistivity Measurements (ρ Position).....	38
5.6.1 Advantages/Disadvantages of Wenner & Schlumberger.....	38
5.6.2 Changing the Measurement Method.....	39
5.6.3 Programming the Distance for Electrode Placement.....	39
5.6.4 Wenner Method	40
5.6.5 Schlumberger Method.....	41
5.7 Earth/Ground Measurements with Two Clamps.....	43
6. MANUAL MODE	45
6.1 Switching the Test Voltage	45
6.2 Measurement Frequency Selection	45
6.3 Manual Settings for m Ω Measurements	46
6.3.1 Continuity Test	46
6.4 3-Pole Earth/Ground Measurements & Coupling.....	47
6.4.1 3-Pole Earth/Ground Measurements	47
6.4.2 Earth/Ground Coupling Measurements	47
6.5 4-Pole Earth/Ground Measurements	49
6.6 Soil Resistivity Measurements	49
6.7 Measurements with Two Clamps	49
6.8 Smoothing.....	49
7. MEMORY FUNCTION	50
7.1 Saving Measurements into Memory.....	50
7.2 Recalling Measurements from Memory	51
7.3 Erasing Measurements from Memory.....	51

7.3.1	Erasing All Measurements	51
7.3.2	Erasing Selective Measurements	51
8.	DATAVIEW® SOFTWARE	52
8.1	Installing DataView®	52
8.2	Ground Tester Control Panel.....	54
9.	MAINTENANCE	55
9.1	Maintenance.....	55
9.2	Cleaning	55
9.3	Fuse Replacement.....	55
9.4	Recharging the Battery	57
9.5	Replacing the Battery.....	58
10.	TROUBLESHOOTING.....	60
10.1	Error Reporting.....	60
10.1.1	Electrode Resistance Too High.....	60
10.1.2	Out of Range.....	60
10.1.3	Misconnection	60
10.1.4	Out of Limits Indicators	60
10.1.5	Error Messages.....	63
APPENDIX A:	GLOSSARY OF TERMS.....	64
Basic Terminologies		64
Glossary		65
Repair and Calibration.....		68
Technical and Sales Assistance		68
Limited Warranty		69
Warranty Repairs.....		69





INTRODUCTION

WARNING

These safety warnings are provided to ensure the safety of personnel. Please **read** and **comply** with these precautions:

- This instrument is protected from accidental voltages of not more than 50V with respect to earth in measurement CAT IV. The guaranteed level of protection of this equipment may be compromised if used in a manner not specified by the manufacturer.
- Safety is the responsibility of the operator.
- All metal objects or wires connected to the electrical system should be assumed to be lethal until tested. Grounding systems are no exception.
- Never exceed the maximum rated voltage and current, and the measurement category.
- Never exceed the protection limits, and always comply with the conditions and place of use, indicated in the specifications.
- Do not use the instrument or its accessories if they appear damaged.
- Use accessories that have overvoltage category and service voltages greater than or equal to those of the instrument (CAT IV 50V). Use only accessories that comply with safety standards (IEC 61010).
- Wear the appropriate protective gear (insulating boots and gloves).
- Check that no terminal is connected and the switch is set to OFF before opening the device.
- Use only the charging unit supplied with the instrument to recharge the battery.
- Troubleshooting and metrological verification procedures must only be performed by qualified, approved personnel, or the factory.
- **NOTE:** The potentials on the various rods used for an earth measurement may be different if a nearby electrical installation is defective or certain weather conditions prevail (thunderstorms). It is up to the operator to decide whether to continue or postpone measurements in these situations.

1.1 International Electrical Symbols

	Signifies that the instrument is protected by double or reinforced insulation.
	This symbol on the instrument indicates a WARNING that the operator must refer to the user manual for instructions before operating the instrument. In this manual, the symbol preceding instructions indicates that if the instructions are not followed, bodily injury, installation/sample and/or product damage may result.
	Risk of electric shock. The voltage at the parts marked with this symbol may be dangerous.
	Ground/Earth symbol
	In conformity with WEEE 2002/96/EC

1.2 Definition of Measurement Categories

CAT II: For measurements performed on circuits directly connected to the electrical distribution system. Examples are measurements on household appliances or portable tools.

CAT III: For measurements performed in the building installation at the distribution level such as on hardwired equipment in fixed installation and circuit breakers.

CAT IV: For measurements performed at the primary electrical supply (<1000V) such as on primary overcurrent protection devices, ripple control units, or meters.

1.3 Receiving Your Shipment

Upon receiving your shipment, make sure that the contents are consistent with the packing list. Notify your distributor of any missing items. If the equipment appears to be damaged, file a claim immediately with the carrier and notify your distributor at once, giving a detailed description of any damage. Save the damaged packing container to substantiate your claim.

1.4 Ordering Information

Ground Resistance Tester Model 6471 (no probes included) Cat. #2135.48

Includes carrying bag 110/240V power adapter with US power cord, optical USB cable, rechargeable NiMH battery, and a USB stick with DataView® software, ground tester workbook and user manual.

Ground Tester Model 6471 (probes included) Cat. #2135.49

Includes carrying bag, set of two SR182 current probes, 110/240V power adapter with US power cord, optical USB cable, rechargeable NiMH battery, and a USB stick with DataView® software, ground tester workbook and user manual.

Ground Tester Model 6471 Kit (300 ft - probes included) Cat. #2135.50

Includes meter, one carrying bag, two 300 ft color-coded leads on spools (red/blue), two 100 ft color-coded leads (hand-tied, green/black), two 5 ft color-coded leads (red/blue), set of two SR182 current probes, 110/240V power adapter with US power cord, optical USB cable, four T-shaped auxiliary ground electrodes, set of five spaded lugs, one 100 ft tape measure, rechargeable NiMH battery, and a USB stick with DataView® software, ground tester workbook and user manual.

Ground Tester Model 6471 Kit (300 ft - no probes included)..... Cat. #2135.60

Includes meter, two carrying bags, two 300 ft color-coded leads on spools (red/blue), two 100 ft color-coded leads (hand-tied, green/black), two 5 ft color-coded leads (red/blue), 110/240V power adapter with US power cord, optical USB cable, four T-shaped auxiliary ground electrodes, set of five spaded lugs, one 100 ft tape measure, rechargeable NiMH battery, and a USB stick with DataView® software, ground tester workbook and user manual.

Ground Tester Model 6471 Kit (500 ft - no probes included)..... Cat. #2135.61

Includes meter, two carrying bags, two 500 ft color-coded leads on spools (red/blue), two 100 ft color-coded leads (hand-tied, green/black), two 5 ft color-coded leads (red/blue), 110/240V power adapter with US power cord, optical USB cable, four T-shaped auxiliary ground electrodes, set of five spaded lugs, one 100 ft tape measure, rechargeable NiMH battery, and a USB stick with DataView® software, ground tester workbook and user manual.

1.4.1 Kits, Accessories and Replacement Parts

Test Kit for 3-Pole (3-Point) Testing (150 ft) Cat. #2135.35

Includes carrying bag, two 150 ft color-coded leads on spools (red/blue), one 30 ft lead (green), two 5 ft color-coded leads (red/blue), two T-shaped auxiliary ground electrodes, set of five spaded lugs and one 100 ft tape measure.

Test Kit for 4-Pole (4-Point) Testing (300 ft) Cat. #2135.36

Includes carrying bag, two 300 ft color-coded leads on spools (red/blue), two 100 ft color-coded leads (hand-tied, green/black), two 5 ft color-coded leads (red/blue), four T-shaped auxiliary ground electrodes, set of five spaded lugs and one 100 ft tape measure.

Test Kit for 4-Pole (4-Point) Testing (500 ft) Cat. #2135.37

Includes carrying bag, two 500 ft color-coded leads on spools (red/blue), two 100 ft color-coded leads (hand-tied, green/black), one 30 ft lead (green), two 5 ft color-coded leads (red/blue), four T-shaped auxiliary ground electrodes, set of five spaded lugs and one 100 ft tape measure.

Test Kit for 3-Pole (3-Point) Testing

(Supplemental for 4-Pole (4-Point) Testing) **Cat. #2135.38**

Includes carrying bag, two 100 ft color-coded leads (hand-tied, green/black), one 30 ft lead (green), two T-shaped auxiliary ground electrodes, set of five spaded lugs and one 100 ft tape measure.

Extra Large Classic Tool Bag **Cat. #2133.73**

Tape Measure - AEMC® (100 ft) **Cat. #2130.60**

Ground Tester DVD/Workbook Set..... **Cat. #2130.64**

Set of two, 14.5" T-shaped Auxiliary Ground Electrodes **Cat. #2135.39**

Replacement - Carrying Bag for Ground Tester **Cat. #2135.40**

Optical USB Cable..... **Cat. #2135.41**

Inverter – 12V DC to 120V AC 200 Watt for vehicle use **Cat. #2135.43**

AC Current Probe Model MN82..... **Cat. #2135.71**

AC Current Probe Model SR182 **Cat. #2135.72**

Replacement - Fuse, set of 5, 0.63A 250V 5x10 1.5kA..... **Cat. #2135.81**

Safety Alligator Clip - Black (Rated 600V CAT IV, 10A)..... **Cat. #2140.53**

Safety Alligator Clip - Green (Rated 600V CAT IV, 10A) **Cat. #2140.69**

Replacement - Battery, Rechargeable NiMH 9.6V **Cat. #2960.21**

Replacement - Power Adapter 110/240V & Power Cord 115V US... **Cat. #5000.13**

Replacement - Power Cord 115V US Plug..... **Cat. #5000.14**

PRODUCT FEATURES

2.1 Description

The Ground Resistance Tester Model 6471 is a portable measurement instrument designed to measure:

- Ground Resistance with 2 clamps (no auxiliary rods needed)
- Bond/Connection Resistance (2-Pole and 4-Pole Kelvin sensing)
- Ground Resistance (3-Pole or 4-Pole)
- Ground Coupling Resistance
- Selective Ground Resistance
- Soil Resistivity (Wenner or Schlumberger method)

The Model 6471 measures from 0.01 to 99.99k Ω and is auto-ranging, automatically seeking out the optimum measurement range, test frequency and test current.

Easy-to-use - Simply connect the leads, select the test mode, press Start and read the results. Up to 512 test results can be stored in internal memory for later recall to the display or downloaded to a PC via DataView[®] software.

The large LCD is easy-to-read and indicates ground electrode resistance, test voltage, current and frequency as well as individual electrode resistance, battery status and more.

The Model 6471 is CAT IV rated to 50V and is over voltage protected to more than 250VAC against accidental connection to live circuits. The voltage is also displayed on screen. In the event of a system fault, the Model 6471 can withstand 250VAC.

Additional features of the Model 6471 include a heavy-duty field case sealed against dust and water when closed (the test button is also sealed against the elements); manual and automatic test frequency selection from 41 to 513Hz; 4-Pole Soil Resistivity test methods and user selectable 2-Pole or 4-Pole Bond Resistance test method.

The Model 6471 is powered by 9.6V, 3.5 Ah NiMH rechargeable batteries. An external recharger powered from 120/230V, 50/60Hz is included and provides for testing while recharging.

The Ground Resistance Tester Model 6471 is rugged, easy-to-use and ideal for maintenance crews performing numerous tests. It exceeds mechanical and safety specifications for shock, vibration and drop tests per IEC standards. The adjustable test frequency provides for rejection of high levels of interference, allowing it to be used under difficult conditions such as high stray currents that affect accuracy.

2.2 Key Features

- Ground Resistance testing using the 2 clamp method (no auxiliary rods needed)
- 2- and 4-Pole Bond Resistance/Continuity measurement (DC Resistance) with automatic polarity reversal
- 4-Pole Soil Resistivity measurement with automatic calculation of Rho (ρ) and user selection of the Wenner or Schlumberger test method
- 3-Pole Earth Coupling measurement
- Manual and Automatic frequency scan from 41 to 513Hz for optimum test accuracy in electrically noisy environments
- Selectable test voltage of 16 or 32V up to 250mA of test current
- Auto-off power management
- Automatic recognition of all electrode connections and their resistance value
- Stores up to 512 complete test results in internal memory
- Optically isolated USB communication
- Remote set up and operation of all measurements using DataView® software
- Rechargeable NiMH batteries from wall charger or vehicle power
- Rugged dustproof and rainproof field case – IP53 rated in closed position
- Grounding standards IEC 61557 parts 4 and 5 compliant
- Includes DataView® software for data storage, real-time display, analysis, report generation and system configuration

2.3 Control Features

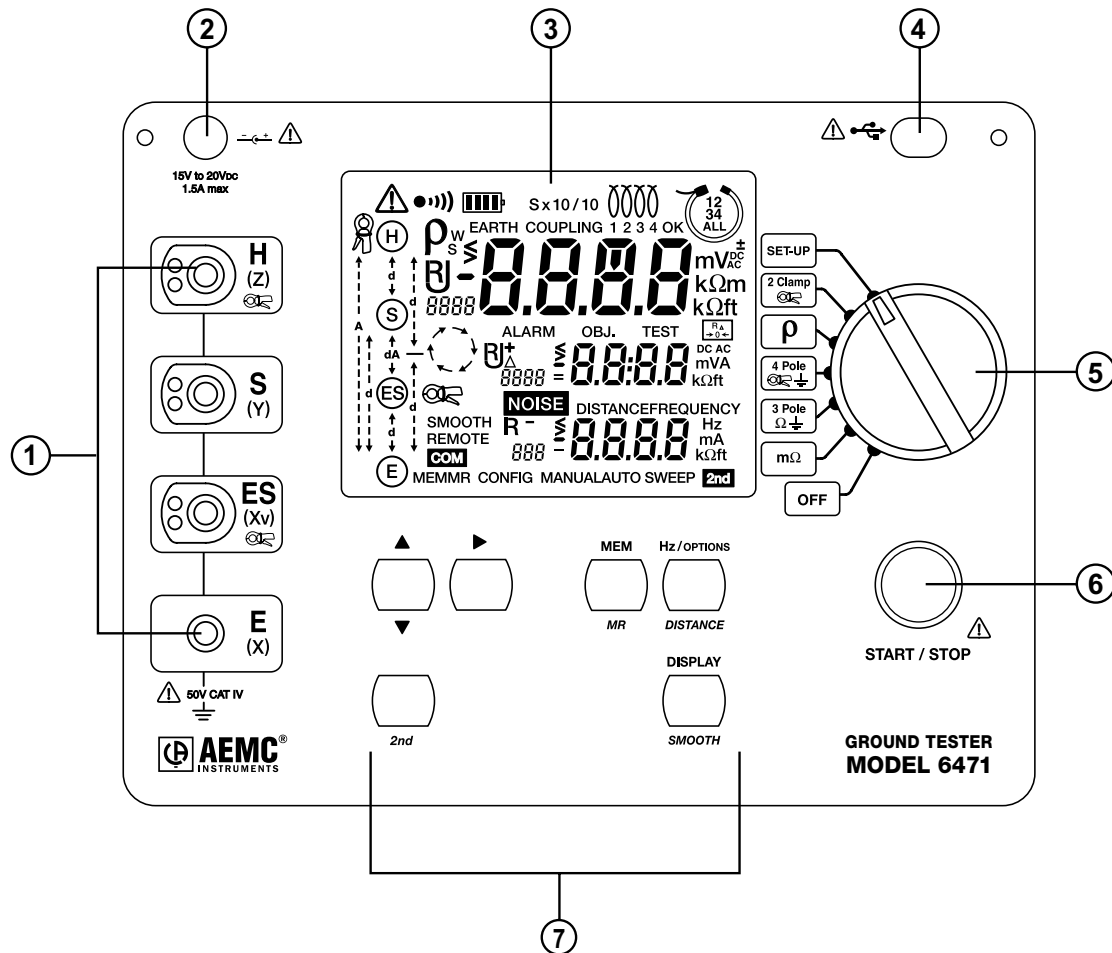

Figure 2-1

1. Four terminals: **H (Z)** (auxiliary electrode), **S (Y)** (electrode), **ES (Xv)** (earth/ground electrode) and **E (X)** (earth/ground electrode)
All terminals accept 4mm Ø banana plugs. Terminals **H (Z)** and **ES (Xv)** also accept special plugs for current clamps. **S (Y)** will take a shielded cable.
2. Connector for charging the battery (see § 9.4).
3. 256 segment multi-line backlit LCD (see § 2.4).
4. Connector for an optical interface to a PC. Either an RS-232 or USB connection can be used (see § 8 - DataView®).
5. Rotary switch: OFF position, 5 measurement functions (see § 5 and 6) and SET-UP function (see § 4.2).
6. START/STOP button: Starts the measurement and compensates for the leads (in the mΩ measurement function - see § 5.2.1).
7. Six function buttons (see § 2.5).

2.4 Display

NOTE: External voltages will be displayed only on the small displays (A2 and A3) without the view of the main display (A1). This helps to rapidly recognize that these are measurements of external voltages.

Backlight: The backlight turns ON automatically when entering a function and turns OFF after the function is complete. Press the **DISPLAY** button to turn it back on.

NOTE: In the Set-up mode, pressing the **DISPLAY** button also selects the next configurable parameter.

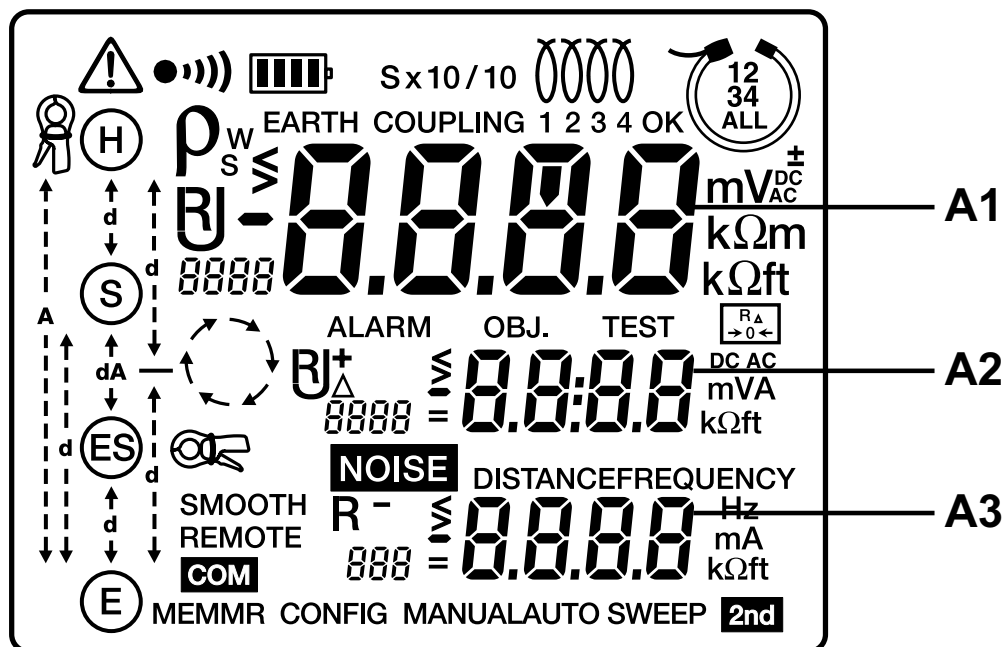













Figure 2-2

A1	Top main display
A2	Middle small display
A3	Bottom small display
	<p>If this symbol <u>blinks</u> during a <u>passive</u> measurement, a voltage of more than 42V is present at the tester's inputs.</p> <p>If this symbol <u>blinks</u> during an <u>active</u> measurement, the limits of use have been exceeded.</p> <p>If the symbol <u>appears constant</u> during an <u>active</u> measurement, the values to be measured are unstable.</p>
	Warning buzzer is activated

> or <	<p>A blinking symbol > (greater than) or < (less than) indicates that the measurement range is exceeded.</p> <p>If both symbols are blinking during a <u>passive</u> measurement, the values of voltage and/or current are too small and are beyond the limits of use. The resistance R_{PASS} displayed by the tester is then highly uncertain.</p> <p>If both symbols are blinking during an <u>active</u> measurement, the values to be measured are strongly varying (remedy: switch on smoothing of measured values with SMOOTH function).</p>
	Indicates the battery charge condition; the segments represent the energy.
EARTH COUPLING	Indicates whether the 3-Pole EARTH measurement or the EARTH COUPLING measurement has been selected.
S x 1/10	Symbol not used in Model 6471
	Symbol not used in Model 6471
	Symbol not used in Model 6471
OBJ:TEST	Object and test number for storage in memory.
	Indicates lead compensation for 2-Pole measurement is active
DISTANCE	If blinking, indicates the value is ready to be overwritten with a new value or that a new value will be entered. If more than one value has to be entered, use the CHANGE ▲ ▼ buttons to move to the next one.
FREQUENCY	Indicates the test frequency.
2nd	Indicates that the secondary function of a button will be used.
SWEEP	Symbol not used in Model 6471
MANUAL	Indicates MANUAL mode - the user has to stop the measurement, otherwise the measurement keeps on running.
AUTO	Indicates AUTO mode - measurement stops immediately after all results are available.
NOISE	If blinking, indicates the measurement had a disturbance when the measurement was started.
CONFIG	Indicates that the blinking value of AUTO/MANUAL mode, frequency, voltage or DC current direction can be changed.
MR	Memory recall - indicates the displaying of stored results is active
MEM	Indicates that there is recorded data in memory. When blinking, it indicates that the results need to be saved by pressing the MEM button.
REMOTE	Indicates the instrument is remotely controlled by the RS-232/USB interface.

SMOOTH	Indicates SMOOTHing of the displayed measurement results.
	Indicates that a clamp is (steady) or should be (flashing) connected to ES.
U	Measured value (R, U, I).
	Indicates that the measurement is running.
ALARM	Indicates the alarm is activated. An audible alarm will sound if the value measured is above the limit defined in the SET-UP mode.
	Distances to be entered between earth electrode and supplementary electrodes or between earth electrodes.
	Clamp should be connected to H. If this clamp symbol blinks, the instrument is refusing measurement because the clamp is not connected correctly.
ρ	Symbolizes the soil resistivity value (Rho): W or S indicates that Wenner or Schlumberger method is used for the measurement (changed by the Hz/OPTIONS button).

2.5 Button Functions

START/STOP	Starts a measurement and compensates for lead resistance (§ 5.2.1). Measurement stops automatically (AUTO) or is stopped by pressing this button again (MANUAL).
2nd	Selects the second function highlighted in yellow under the buttons.
	Increases or decreases the value of the flashing parameter displayed or selects the next parameter. Press the button for a longer time to increase the change of value speed at a faster rate.
	Selects the parameter to be modified or moves the cursor to the right.
MEM/MR	MEM: Stores measurements to memory. MR: Retrieves measurements from memory.
DISPLAY/SMOOTH	DISPLAY: Displays all parameters of a measurement. SMOOTH: Smooths the display of measurement providing a more stable result.
Hz/OPTIONS/DISTANCE	Hz/OPTIONS: Enables configuration of measurement functions. DISTANCE: Available for soil resistivity and V potential measurements. It allows the setting of values of distances used for Rho (ρ) calculation.

SPECIFICATIONS

3.1 Reference Conditions

Influencing Parameters	Reference Values
Temperature	68°F ± 5.5°F (20°C ± 3°C)
Relative Humidity	45 to 55% RH
Power Supply	9 to 11.2V
Frequency Range of Input Signal	0 to 440Hz
Capacitance Parallel to Input Resistance	0 uF
Electric Field	<1 V/m
Magnetic Field	< 40 A/m

3.2 Electrical

3.2.1 Frequency Measurements

Measuring method: Digital with a sampling frequency of 4028Hz, low pass, FFT. The frequency of the strongest spectral component is displayed.

Measuring rate: Display updates approx. 3 times per s.

Measurement Range	5 to 450Hz
Resolution	1Hz
Operating error	± 2Hz
Min. input voltage	10mV
Min. current through a clamp	0.5mA

3.2.2 Voltage Measurements

Overvoltages up to 75Vrms are displayed as ">65V". Permanent overvoltages between 70 and 75V at terminals **H (Z)** and **E (X)** can cause overheating of the overvoltage protection varistor.

Voltages of more than 75Vrms lead to error message 31 (excessive external voltage) or 32 (voltage measurement overrange).

If terminals **H (Z)** and **E (X)** are put into contact with the line voltage, the protection fuse will blow.

External Voltage Measurements

Measuring Method: Digital by sampling at 4028Hz, low pass filter, FFT.
The frequency of the strongest spectral component is displayed.

Measuring Rate: Display updates approx. 3 times per s.

Signal Conversion: TRMS or sum of all harmonics 10 to 450Hz during selective earth measurements with a clamp.

Measured Range	0.00 to 9.99V	10 to 65V
Resolution	0.01V	0.1V
Intrinsic error	$\pm (2\% + 1\text{ct})$	
Operating error	$\pm (5\% + 1\text{ct})$	
Input impedance Z_{H-E} , Z_{S-E} (Z_{S-ES})	1.2M Ω	
Operating frequency	DC and 15 to 440Hz	

3.2.3 Current Measurements

External Current Measurements

Measuring Method: Digital by sampling at 4028Hz, low pass filter, FFT.

Measuring Rate: Display updates approx. 3 times per s.

Signal Conversion: Sum of all harmonics 10 to 450Hz

With Current Probe SR182

Measurement Range	0.00 to 9.99mA	10.0 to 99.9mA	100 to 999mA	1.00 to 9.99A	10 to 40A
Resolution	0.01mA	0.1mA	1mA	0.01A	0.1A
Frequency range	16 to 49Hz		50 to 99Hz		100 to 400Hz
Operating error from 0.5 to 100mA	$\pm (10\% + 2\text{cts})$		$\pm (5\% + 2\text{cts})$		$\pm (3\% + 2\text{cts})$
Operating error from 0.1 to 40.0A	> 20%		$\pm (10\% + 2\text{cts})$		$\pm (5\% + 2\text{cts})$

With Current Probe MN82

Measurement Range	0.00 to 9.99mA	10.0 to 99.9mA	100 to 999mA	1.00 to 9.99A	10 to 40A ⁽¹⁾
Resolution	0.01mA	0.1mA	1mA	0.01A	0.1A
Frequency range	16 to 49Hz ⁽¹⁾		50 to 99Hz ⁽¹⁾		100 to 400Hz
Operating error from 0.5 to 100mA	± (15% + 2cts)		± (7% + 2cts)		± (5% + 2cts)
Operating error from 0.1 to 40.0A	> 20%		± (15% + 2cts)		± (7% + 2cts)

(1): The Model 6471 cannot detect whether a current clamp SR182 or MN82 is connected. In the case of the MN82 clamp, with currents > 10A and frequencies < 100Hz the instrument will not display any warning messages. It is the operator's responsibility to observe the limits of use when using the MN82 clamp.

3.2.4 DC Resistance Measurements

Measuring method: Voltage/Current measurement (Standard EN 61557 part 4)

Nominal output voltage: 16VDC (if resistance < 22Ω the output voltage is reduced to 10VDC)

Max output current: > 200mADC for resistances < 20Ω

Max overload (permanent): 50Vrms (protection up to 250V is guaranteed)

Max inductive load: 2 H

Max interfering voltage: 60Vpeak > 10Hz

Time for auto range selecting: approx 5 s

Measuring time: 8 s with automatic polarity inversion

Measuring rate: 3 per s in manual mode

Lead compensation: Possible from 0 to 5Ω

Alarm setting: ">" or "<" from 1 to 999Ω (max 3 digits)

2-Pole mΩ measurement

Measurement Range	0.12 to 9.99Ω	10.0 to 99.9Ω	100 to 999Ω	1.00 to 9.99kΩ	10.0 to 99.9kΩ
Resolution	0.01Ω	0.1Ω	1Ω	10Ω	100Ω
Intrinsic error	± (2% + 2cts)				
Operating error	± (5% + 3cts)				

4-Pole mΩ measurement

Measurement Range	0.020 to 9.999Ω	10.00 to 99.99Ω	100.0 to 999.9Ω	1.000 to 9.999kΩ	10.00 to 99.99kΩ
Resolution	0.001Ω	0.01Ω	0.1Ω	1Ω	10Ω
Intrinsic error	± (2% + 2cts)				
Operating error	± (5% + 5cts)				

3.2.5 AC Earth/Ground Resistance Measurements

Measuring method: Voltage/Current measurement (EN 61557 part 5)

Open circuit voltage: 16 or 32Vrms square wave (if current > 240mA the output voltage is reduced to 10Vrms)

Test frequency: Selectable from 41 to 513Hz (see table in § 6.2)

Short circuit current: > 200mAAC

Noise suppression: > 80 dB for frequencies 20% or more above or below the test frequency

Max. overload: 250Vrms

Max. value for R_H & R_S : 100kΩ

Measuring time: **Short push on START:** approx. 7 s for first value of R_E at 128Hz, then 3 measurements per s.

Long push on START: approx. 15 s for first value of R_E at 128Hz, then 3 measurements per s.

The following error indications refer to reference conditions with a test voltage of 32V, test frequency of 128Hz, R_H and $R_S = 1kΩ$, no external voltage.

The operating error of AC resistance measurements can be less than that specified for voltage or current because frequency characteristics of the voltage channel are matched to those of the current channel.

Measurement of auxiliary electrodes R_H , R_S , R_{ES} , R_E

Measurement Range	0.14 to 9.99Ω	10.0 to 99.9Ω	100 to 999Ω	1.00 to 9.99kΩ	10.0 to 99.9kΩ
Resolution	0.1Ω	0.1Ω	1Ω	10Ω	100Ω
Operating error	± (10% + 2cts)				

The **START** button must be pressed for more than 2 s. For frequencies between 41 and 256Hz, the resistance of the auxiliary earth electrodes is measured at the test frequency set. At higher frequencies the resistance is measured at 256Hz.

3-Pole earth resistance measurement R_E

Measurement Range	0.09 to 9.99 Ω	10.0 to 99.9 Ω	100 to 999 Ω	1.00 to 9.99k Ω	10.0 to 99.9k Ω
Resolution	0.01 Ω	0.1 Ω	1 Ω	10 Ω	100 Ω
Intrinsic error	$\pm (2\% + 1ct)$				

Operating conditions: $R_E < 3 \times R_H$, $U_{OUT} = 32V$			Operating error for R_E
Values for R_H , R_S and R_E		Frequency (Hz)	
$(R_H + R_S) / R_E < 3000$	$R_H \geq 0\Omega$, $R_S \leq 3k\Omega$	41 to 513	$\pm (3\% + 2cts)$
	$R_H > 3k\Omega$, $R_S \leq 30k\Omega$	41 to 513	$\pm (10\% + 2cts)$
$(R_H + R_S) / R_E < 5000$	$R_H > 30k\Omega$, $R_S < 100k\Omega$	41 to 128	$\pm (10\% + 3cts)$

Note: For a test voltage U_{OUT} of 16V, halve the value for R_H .

4-Pole earth resistance measurement R_E

Measurement Range	0.01 to 9,999 Ω	10.00 to 99.99 Ω	100.0 to 999.9 Ω	1.000 to 9.999k Ω	10.00 to 99.99k Ω
Resolution	0.001 Ω	0.01 Ω	0.1 Ω	1 Ω	10 Ω
Intrinsic error	$\pm (2\% + 1ct)$				

Operating conditions: $R_E < 3 \times R_H$, $U_{OUT} = 32V$			Operating error for R_E
Values for R_H , R_S and R_E		Frequency (Hz)	
$(R_H + R_S) / R_E < 3000$	$R_H \geq 0\Omega$, $R_S \leq 3k\Omega$	41 to 513	$\pm (3\% + 2cts)$
	$R_H > 3k\Omega$, $R_S \leq 30k\Omega$	41 to 513	$\pm (10\% + 2cts)$
$(R_H + R_S) / R_E < 5000$	$R_H > 30k\Omega$, $R_S < 100k\Omega$	41 to 128	$\pm (10\% + 3cts)$

Note: With a test voltage U_{OUT} of 16V, halve the value of R_H .

Selective 4-Pole earth resistance measurement with SR182 or MN82 clamp

Same characteristics as 4-Pole earth measurements with the following particular conditions:

Minimum current: SR182, $I_{ES} > 0.5mA$
 MN82, $I_{ES} > 2mA$

Maximum R_{SEL} / R_E ratio: SR182, $(R_{SEL} / R_E) < 500$
 MN82, $(R_{SEL} / R_E) < 120$
 with $R_H + R_E < 20\Omega$

3.2.6 Soil Resistivity Measurement ρ

Measuring method: Voltage/Current measurement (EN 61557 part 5)

Open circuit voltage: 16 or 32Vrms square wave

Test frequency: Selectable from 41 to 128Hz (see table in § 6.2)

Short circuit current: > 200mAAC

Noise suppression: > 80 dB for frequencies 20% or more above or below the test frequency

Max. overload: 250Vrms

Max. value for R_H , R_S , R_{ES} , R_E : 100k Ω

Calculation formula, Wenner: $\rho_W = 2\pi d R_{S-ES}$

Calculation formula, Schlumberger: $\rho_S = (\pi (d^2 - (A/2)^2) / A) R_{S-ES}$

Maximum value of ρ : 999k Ω m (display in k Ω ft is not possible)

Measuring time: **Short push on START:** approx. 8 s for first value of R_{S-ES} at 128 Hz, then 3 measurements per s.

Long push on START: approx. 20 s for first value of R_{S-ES} at 128 Hz, then 3 measurements per s.

Measurement Range	0.00 to 9.99 Ω	10.0 to 99.9 Ω	100 to 999 Ω	1.00 to 9.99k Ω	10.0 to 99.9k Ω
Resolution	0.01 Ω	0.1 Ω	1 Ω	10 Ω	100 Ω
Intrinsic error	$\pm (2\% + 1ct)$				

The intrinsic error specified refers to reference conditions with a test voltage of 32V, test frequency of 128Hz, $R_{\rho-H}$, $R_{\rho-S}$, $R_{\rho-ES}$ and $R_{\rho-E} = 1k\Omega$, no external voltage.

Operating conditions : $R_{S-ES} < 3 \times R_{\rho-H}$ and:	Operating error for R_{S-ES}
$R_{\text{electrode}} \leq 100k\Omega$ $R_{\text{electrode}} / R_{S-ES} \leq 2000$	$\pm (7\% + 2cts)$
$R_{\text{electrode}} \leq 50k\Omega$ $R_{\text{electrode}} / R_{S-ES} \leq 10,000$	$\pm (15\% + 3cts)$
$R_{\text{electrode}} \leq 10k\Omega$ $R_{\text{electrode}} / R_{S-ES} \leq 20,000$	$\pm (20\% + 1ct)$

R_{rod} is the resistance of the earth rods $R_{\rho-E}$, $R_{\rho-ES}$, $R_{\rho-E}$, $R_{\rho-H}$ assumed to be identical.

Note: With a test voltage U_{OUT} of 16V, halve the value of R_{rod} .

Measurement of auxiliary electrodes $R_{\rho-H}$, $R_{\rho-S}$, $R_{\rho-ES}$, $R_{\rho-E}$

Measurement Range	0.14 to 9.99 Ω	10.0 to 99.9 Ω	100 to 999 Ω	1.00 to 9.99k Ω	10.0 to 99.9k Ω
Resolution	0.1 Ω	0.1 Ω	1 Ω	10 Ω	100 Ω
Operating error	$\pm (10\% + 2\text{cts})$				

The **START** button must be pressed for more than 2 s. For frequencies between 41 and 128Hz, the resistance of the auxiliary earth electrodes is measured at the test frequency set. At higher frequencies the resistance is measured at 128Hz.

3.2.7 Earth/Ground Measurements with 2 Clamps

Measuring method: Voltage/Current measurement with a rectangular AC signal

Induced short circuit current: < 26Arms (with SR182) < 5Arms (with MN82)

Signal frequency: Automatic: 1611Hz - Manual: 128, 1367, 1611 or 1758Hz

Noise suppression: > 80 dB at frequencies differing by 20% or more from the test frequency

Max. interfering current: 20A_{peak}

Max. value for R_H , R_S : 100k Ω

Measuring time: approx. 7 s for the first value of R_{Loop} , then 3 meas. per s.

Measurement Range		0.10 to 9.99 Ω	10.0 to 99.9 Ω	100 to 500 Ω
Measurement frequency		1367Hz - 1611Hz - 1758Hz		
Resolution		0.01 Ω	0.1 Ω	1 Ω
Operating error ⁽¹⁾ (without external current)	SR182	$\pm (10\% + 1\text{cts})$		
	MN82	$\pm (20\% + 2\text{cts})$		

Measurement Range		0.10 to 9.99 Ω	10 to 30 Ω
Measurement frequency		128Hz	
Resolution		0.01 Ω	0.1 Ω
Operating error ⁽¹⁾ (without external current)	SR182	$\pm (20\% + 2\text{cts})$	
	MN82	not specified	

(1): Observe the minimum distance between the two clamps according to table in § 5.7.

3.3 Data Storage

Memory Capacity: 512 test results (64kB)

Communication: Optically isolated USB

3.4 Power

Power Source: Rechargeable 9.6V, 3.5Ah NiMH Battery Pack

Power Supply: 110/220, 50/60Hz external charger with 18VDC, 1.9A output or 12VDC vehicle power

Fuse: 0.63A, 250V, 5x20mm, 1.5kA

Battery Life:

Function	Power consumed	Typical number of measurements ⁽¹⁾
Device off	< 5 mW	—
Voltage Measurement	1.5 W	4500
mΩ ⁽²⁾	4.9 W	1500
3-Poles, 4-Pole ⁽³⁾	4.9 W	1500
ρ ⁽⁴⁾	4.9 W	1500
2 Clamps	3.7 W	2000

(1): Measurements in automatic mode at 25-s intervals

(2): With R = 1Ω

(3): With R_H + R_E = 100Ω

(4): With R_H + R_{S-ES} = 100Ω

3.5 Mechanical

Dimensions: 10.7 x 9.76 x 5.12" (272 x 248 x 130mm)

Weight: 7 lbs (3.2kg) approx

Case Material: ULV0 Polypropylene

Terminals: 4mm recessed banana jacks

Case Protection: EN 60529 - IP53 (cover closed)

Drop Test: Per EN 61010

Vibration Test: Per EN 61557-1

3.6 Environmental

Operating Temperature: 32° to 113°F (0° to 45°C); 0 to 90% RH

Specified Operating Temperature⁽¹⁾: 0° to 95°F (0° to 35°C); 0 to 75% RH

Storage Temperature: -40° to 158°F (-40° to 70°C); 0 to 90% RH

Altitude: < 3000m

(1): This range corresponds to the one defined by standard EN 61557, for which an operating error including the quantities of influence is defined. When the device is used outside this range, 1.5%/10°C and 1.5% between 75 and 90% RH must be added to the operating error.

3.7 Safety

Electromagnetic Compatibility

This instrument satisfies the EMC and LVD directives required for the CE marking and product standard IEC 61326.

- Immunity in industrial environment
- Emissions in residential environment.

Electrical safety according to EN 61010

Measurement according to EN 61557.

CAT IV, 50V

Pollution Degree 2

**Specifications are subject to change at any time without notice*

OPERATION



NOTE: For detailed information regarding ground resistance testing, see the *Understanding Ground Resistance Testing Workbook CD* that was included with the instrument.

4.1 General Operating Instructions

The Model 6471 has operating modes:

- **Automatic** mode for routine applications.
- **Manual (Expert)** mode in which the user can change the parameters of the measurement functions.



NOTE: Fully charge the battery before the first use (see § 9.4)

4.1.1 Automatic Mode

- Set the switch to the desired function.
- Make the connections appropriate to the function.
- Press the **START/STOP** button. The device makes the measurement and stops automatically.
- Read the measurement result on the display and the relevant parameters using the **DISPLAY** button.
- To save the information in memory, use the **MEM** button (see § 7.1).

4.1.2 Manual (Expert) Mode

- Set the switch to the desired function.
- Make the connections appropriate to the function.
- Select **MANUAL** mode.
- Choose various measurement parameters using the **Hz/OPTIONS** button.
- Press the **START/STOP** button. The measurement frequency or the direction of the current (resistance measurement) can be changed during the measurement. To view their impact upon the measurement and the parameters relevant to the measurement use the **DISPLAY** button.

- When the measurement results are acceptable, stop the measurement by pressing the **START/STOP** button.
- View the result on the display and toggle through the relevant parameters using the **DISPLAY** button.
- To record the information into memory, use the **MEM** button (see § 7).

4.2 Instrument Configuration (SET-UP mode)

To configure the Model 6471 parameters, turn the rotary switch to **SET-UP**:

- All the segments on the display are activated for 1 second and then the “PUSH button” message appears on the display.
- Various parameters are accessible by pressing the corresponding button.
- The number or symbol which can be modified flashes. These are changed using the **SELECT button [▶]** and **CHANGE buttons [▲ ▼]**.
- **To exit SET-UP**, turn the rotary switch to another position.
- All of the parameters that are modified are permanently saved until a new instrument configuration is performed.

Parameter to be modified	Button	Possible values
Date and Month	HZ/OPTIONS (1 st press)	yyyy.mm.dd*
Time	HZ/OPTIONS (2 nd press)	hh : mm*
Baud Rate	HZ/OPTIONS (3 rd press)	9.6k / 19.2k / 38.4k
Default configuration	HZ/OPTIONS (4 th press)	yes / no
Distance unit	DISPLAY (1 st press)	m (meter) or ft (feet)
Alarm (for mΩ and 2-Pole measurements only)	DISPLAY (2 nd press)	ON / OFF direction (< or >) value (1 to 999Ω)
Buzzer	DISPLAY (3 rd press)	ON / OFF
Modbus address	DISPLAY (4 th press)	1 to 247
Memory used	MEM (1 st press)	000 to 512 (total number of locations)
Memory location	MR (1 st press)	OBJ:TEST

**International format date and time only*

AUTOMATIC MODE



VOLTAGE CHECK: The tester first checks for possible interference. If there is an external voltage of more than 42V, the warning triangle  will be displayed. If measurements are being performed in **AUTO** mode and a disturbance frequency is detected, the tester will automatically look for a frequency that is different from the default 128Hz.

5.1 Switching the Test Voltage

Available in all functions except $m\Omega$ and 2 Clamp.

If necessary, the test voltages can be switched to either 16 or 32V as follows:

- Press the **Hz/OPTIONS** button, then press it again to make the output voltage (Uout) blink.
- Use the **▶** button to switch to 16 or 32V, then press **Hz/OPTIONS** again.

This setting is retained when the unit is turned off.

5.2 Resistance Measurement $m\Omega$ (2-Wire)



WARNING: Before performing the resistance test, verify that the sample under test is not energized.

1. Set the switch to .
2. Connect the resistance to terminals **H (Z)** and **E (X)**.

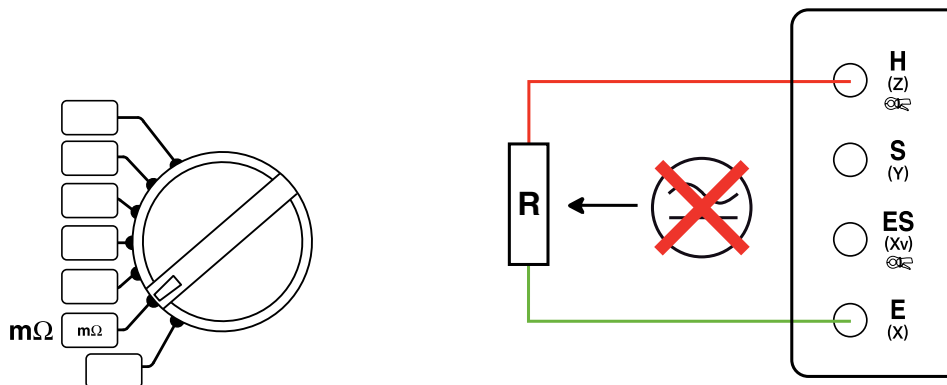

3. The 6471 makes a measurement with a positive current (R+), then reverses the direction of the current and makes another measurement with negative (R-).

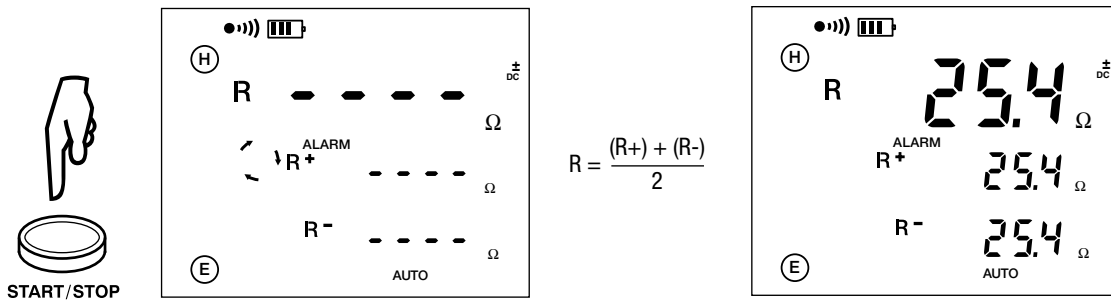

4. To display the measurement parameters, press **DISPLAY** several times.

The device displays the following parameters:

R+, R-, +U_{H-E}, +I_{H-E}, -U_{H-E}, -I_{H-E}, U-Act (U_{H-E} and its frequency) and R_{Δ0} if there is compensation for the measurement leads.

5.2.1 Lead Compensation Measurement

Lead compensation subtracts the resistance of the test leads from the measured result.

- Short the two measurement leads connected to **H (Z)** and **E (X)** terminals.
- Press the **2nd** button, then the **START/STOP** button to start the measurement.
- This value will be deducted from all resistance values measured thereafter until the rotary switch is turned to another function.

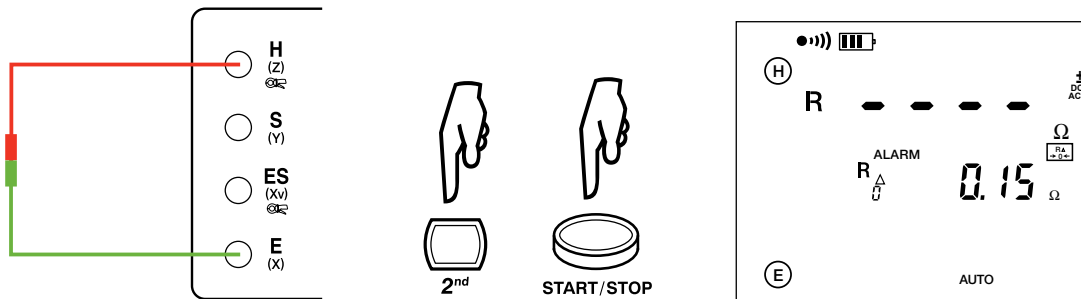

$R_{\Delta} \rightarrow 0 \leftarrow$ appears on the display after the compensation value has been measured.



NOTE: If the compensation resistance is > 5Ω, or if the leads are not shorted when the measurement is started, the value of compensation will be canceled.

5.2.2 Alarm Function

This function is active only for 2-Pole resistance measurements. By default, the visual alarm (ALARM symbol flashes) and the audible alarm (buzzer sounds for a few seconds) are triggered when $R < 2\Omega$.

This threshold can be changed using the **SET-UP** function:

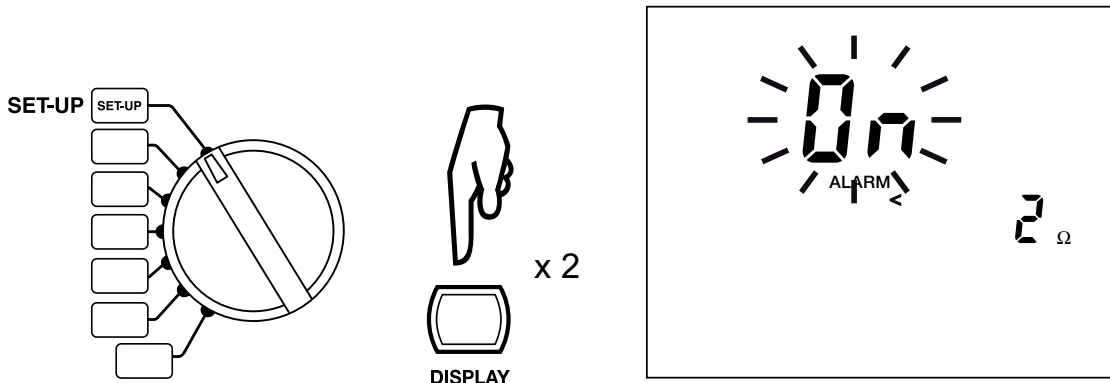

Turn the alarm
ON or OFF



Access the
type of alarm



Choose a low (<) or
high (>) alarm



Set the value of the alarm
between 1 and 999Ω

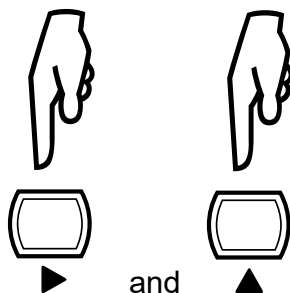

Complete the adjustment
of the alarm setting

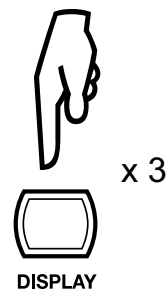

5.3 Resistance Measurement mΩ (4-Wire)

This measurement is used to improve the resolution (10x better than the 2-Wire measurement) for weak resistance values.

To perform a 4-Wire measurement:

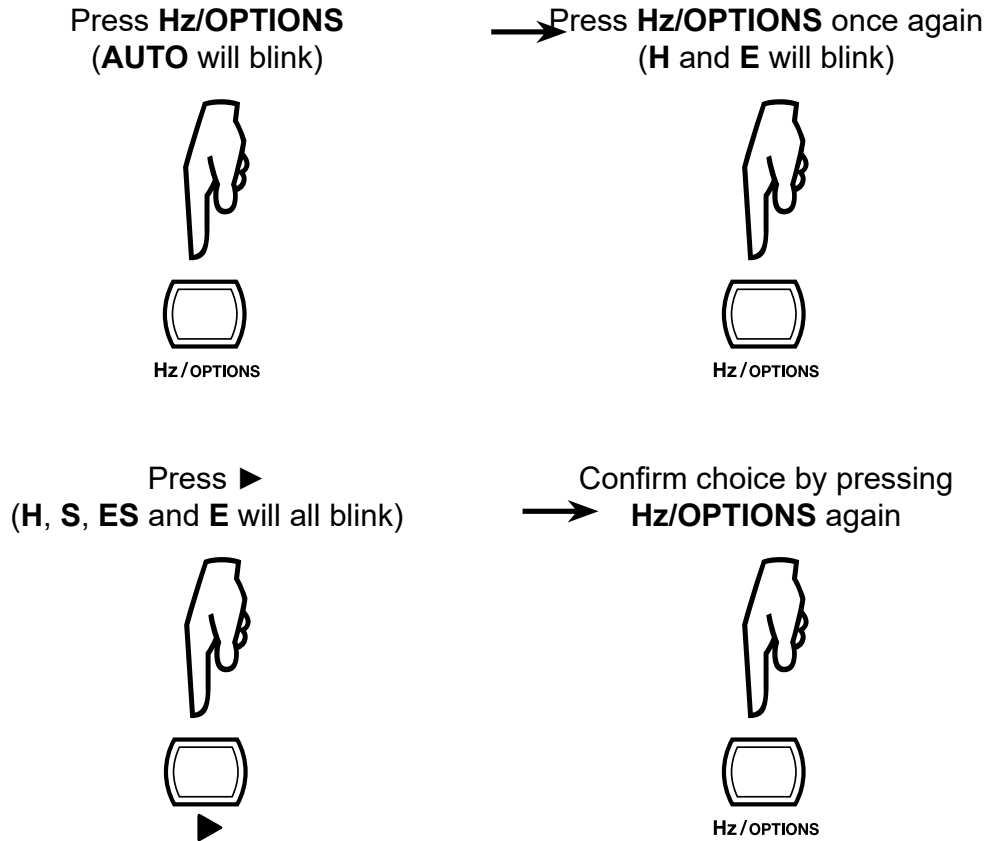

WARNING: Before performing the resistance test, verify that the sample under test is not energized.

1. Set the switch to mΩ.
2. Connect the resistance to all 4 terminals.

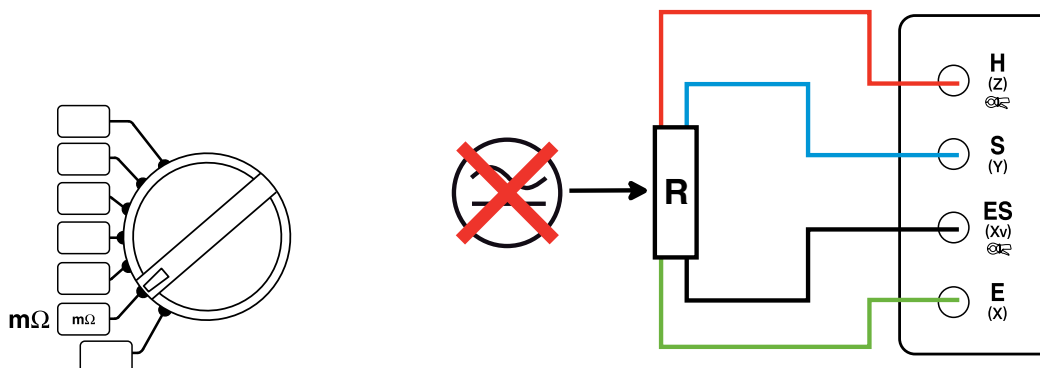

3. Start the measurement by pressing the **START/STOP** button.

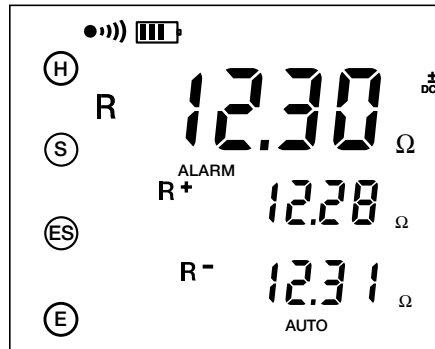
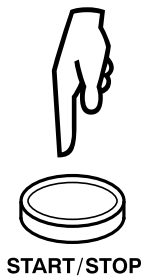

4. To display the measurement parameters, press **DISPLAY** several times.

The device displays the following parameters:

R^+ , R^- , $+U_{H-E}$, $+I_{H-E}$, $-U_{H-E}$, $-I_{H-E}$, U-Act (U_{H-E} and its frequency)

5.4 Earth/Ground Measurement (3-Pole)

This function is used to measure an earth (ground) resistance with 2 auxiliary electrodes.

There are several measurement methods, the full and simplified (62% method) will be discussed in this section.

5.4.1 62% Method

1. Set the switch to .
2. Place electrodes **H (Z)** and **S (Y)** to form a straight line with the earth electrode under test.

The distance between electrode **S (Y)** and the earth electrode is 62% of the distance between electrode **H (Z)** and the earth electrode; the distance between the electrodes **H (Z)** and **E (X)** should be 8 to 10 times the depth of the rod you are testing.

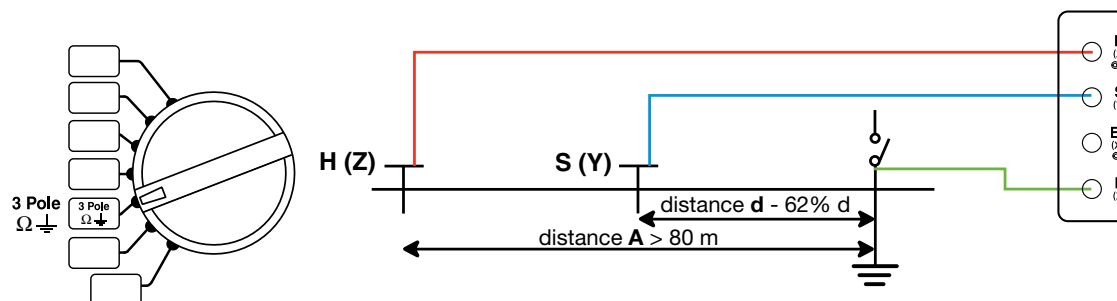

In order to avoid electromagnetic interference, it is best to unwind the full length of each cable from the reel, to keep the cables as far apart as possible on the ground,

taking care not to form loops, and to avoid placing the cables near or parallel to metallic conductors (cables, rails, fences, etc.).

Connect the cables to terminals **H (Z)** and **S (Y)** (red and blue respectively); disconnect the earth strap from the rod under test, then connect terminal **E** (green) to the rod or electrode system to be tested.

3. Press the **2nd** button, then the **DISTANCE** button. The "hundredths" will blink.

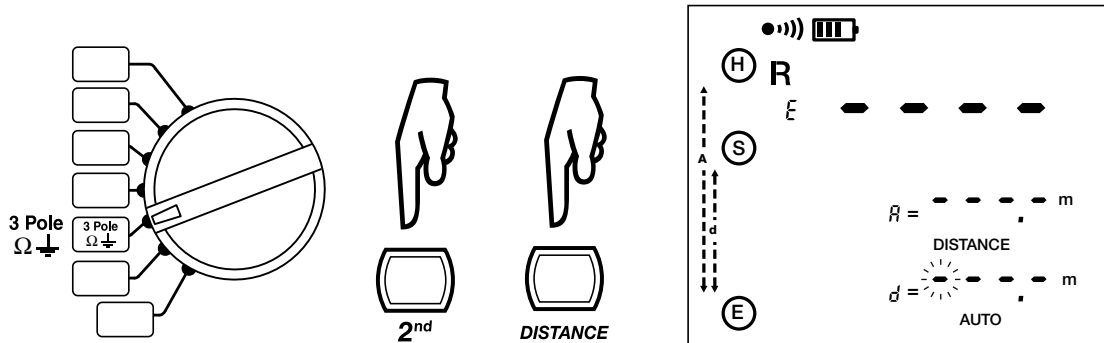

4. To modify the hundredths (of meters or feet), press the ▲ button until the desired digit is displayed (0-9).
5. To select and modify the tens, press the ► button and then the ▲ button until the desired digit is displayed (0-9).
6. To select and modify the units and tenths of a unit, press the ► button and then the ▲ button until the desired digits are displayed (0.0-9.9).
7. To terminate the programming of distance, press the **2nd** button and then the **DISTANCE** button.

It is also necessary to program distance **A**. This is done in the same way as for distance **d**.

8. Start the measurement by pressing the **START/STOP** button.

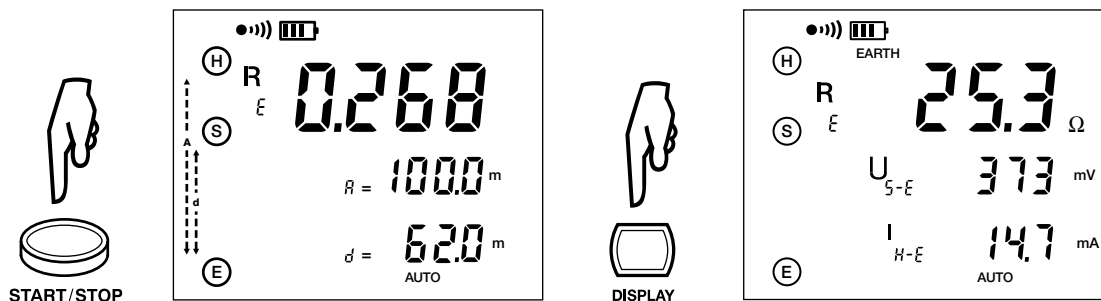

9. To display the measurement parameters, press **DISPLAY** several times.

The device displays the following parameters:

R_E , U_{S-E} , I_{H-E} , U-Act (U_{H-E} and its frequency, U_{S-E} and its frequency).

To measure the resistances of auxiliary electrodes **H (Z)** and **S (Y)**, or if the resistance of the electrodes is too high (see § 10.1), start the measurement with a long press of the **START/STOP** button.

R_H , R_S will be displayed.

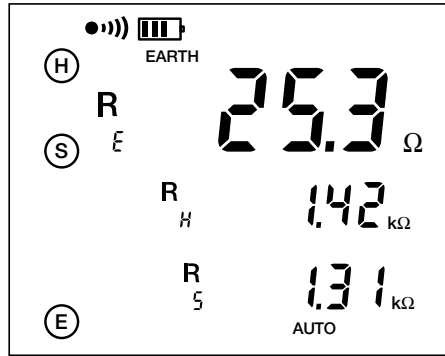
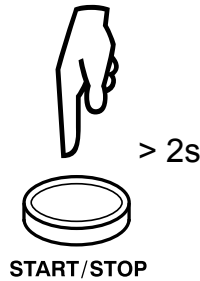

NOTE: Repeat the process at 52% and at 72% for the S electrode.

5.4.2 Full Method

A more thorough measurement can be obtained by taking measurement by moving the **S (Y)** auxiliary electrode every 10% between **H (Z)** and **E (X)** and plotting the results. A distinct plateau should result as shown below.

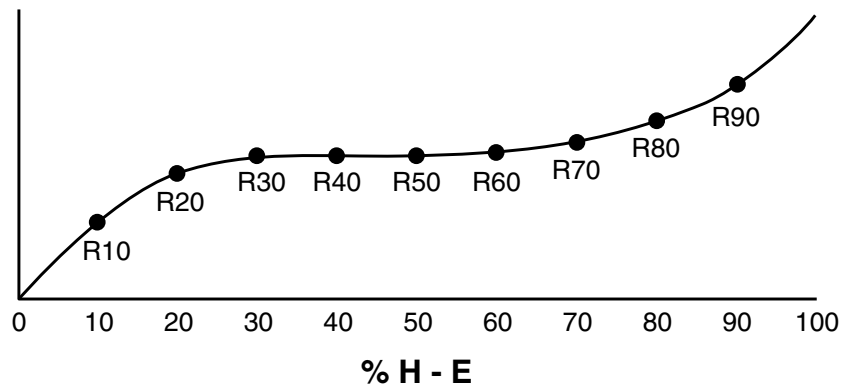

Take the average of the 3 or 4 readings on the plateau to obtain the earth electrode resistance.

$$R = \frac{R_{40} + R_{50} + R_{60} + R_{70}}{4}$$

5.4.3 Recommendations for a Reliable Measurement

Moving the Auxiliary Electrodes

Move electrode **S (Y)** towards electrode **H (Z)** by a distance equal to 10% of **d** and make another measurement. Then move electrode **S (Y)** again by a distance equal to 10% of **d**, but towards the earth electrode.

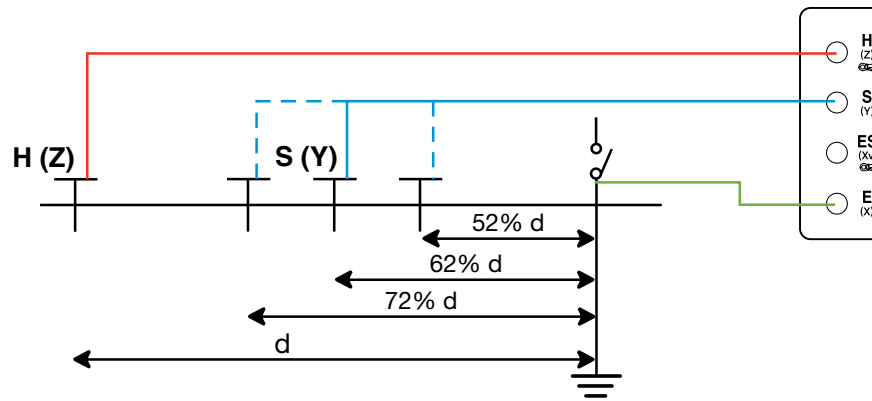

The 3 measurement results should be the same to within a few percent. If this is the case, the measurement is valid.

If not, electrode **S (Y)** is in the zone of influence of the earth electrode. It will be necessary to increase distance **d** for the **H (Z)** auxiliary electrode and repeat the measurements.

Positioning of the Auxiliary Electrodes

To make sure that your earth measurements are not distorted by interference, we recommend repeating the measurement with the auxiliary electrodes placed at a different distance and in another direction (for example, rotated 90° from the first alignment).

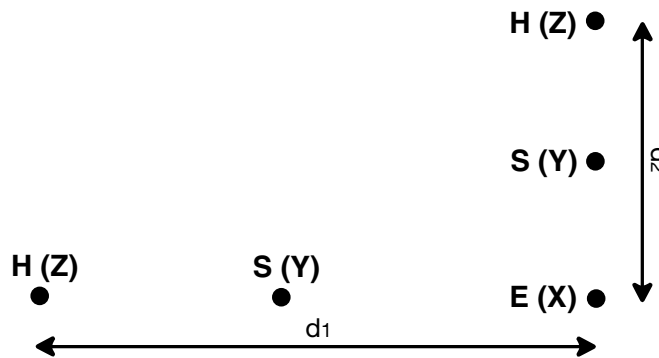

If you find the same values, your measurement is reliable. If the measured values are substantially different, it is likely that they were influenced by earth currents or a groundwater source. It may be useful to drive the electrodes deeper and/or wet the ground near them to reduce their contact resistance with the soil.

Avoid routing the connecting cables of the earth electrodes near or parallel to other cables (transmission or supply), metallic conductors, rails, or fences: high test frequencies may cause cross-talk and affect the measurements.

5.5 Earth/Ground Measurement (4-Pole)

5.5.1 Measurement without a Clamp

This function is suited to the measurement of very low earth resistances. It provides better resolution (10x better than 3P measurement) and there is no need to compensate for the resistance of the measurement leads.

1. Set the switch to .
2. Place electrodes **H (Z)** and **S (Y)** at least 30m apart.

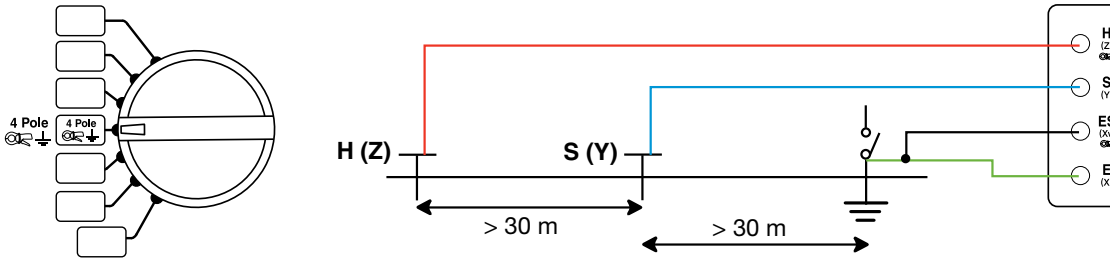

In order to avoid electromagnetic interference, it is best to unwind the full length of each cable from the reel, to keep the cables as far apart as possible on the ground, taking care not to form loops, and to avoid placing the cables near or parallel to metallic conductors (cables, rails, fences, etc.). Connect the cables to terminals **H (Z)** and **S (Y)**; disconnect the earth strap from the rod under test, then connect terminals **E (X)** and **ES (Xv)** to the earth electrode to be tested.

3. Start the measurement by pressing the **START/STOP** button.

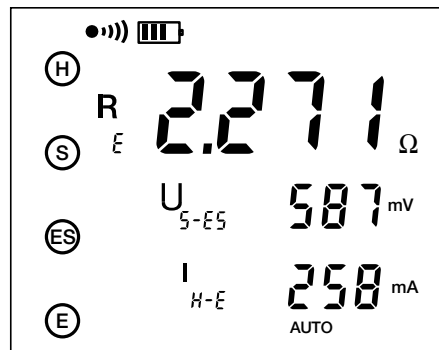
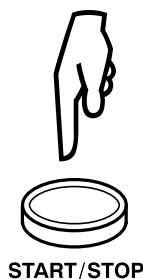

4. To display the measurement parameters, press **DISPLAY** several times.

The device displays the following parameters:

R_E , U_{S-E} , I_{H-E} , U-Act (U_{H-E} and its frequency, U_{S-E} and its frequency).

To measure the resistances of auxiliary electrodes **H (Z)** and **S (Y)**, or if the resistance of the electrodes is too large (see § 10.1), start the measurement with a long press of the **START/STOP** button.

R_H , R_S , U_{H-E} will be displayed.

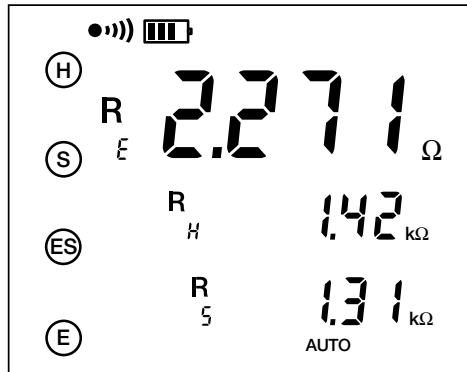
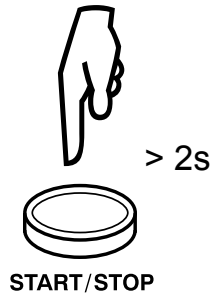

We recommend repeating the measurement with the auxiliary electrodes placed at a different distance and in another direction (see § 5.4.3).

5.5.2 Measurements with a Clamp

For this selective earth measurement you need a current clamp, either an SR182 (provided) or an MN82 (available as an accessory). These two types of current clamps are specially designed to work with the 6471 ground tester.

The SR182 is more precise, suited to the measurement of higher currents (up to 40Arms) and for use on thicker conductors, while the MN82 (which is easier to handle) accepts currents up to 10Arms and can be placed on conductors up to 3/4" (20mm) in diameter.

1. Set the switch to .
2. Place electrodes **H (Z)** and **S (Y)** at least 30m (98 ft) apart so that there is no interference between them.

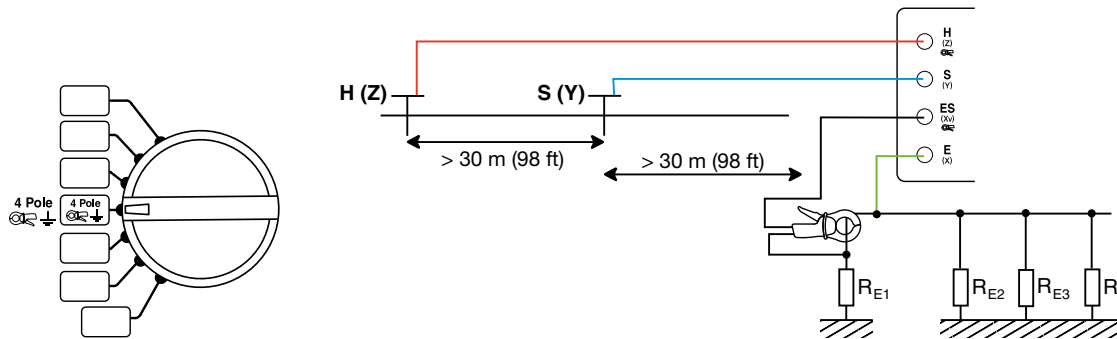

In order to avoid electromagnetic interference, it is best to unwind the full length of each cable from the reel, to keep the cables as far apart as possible on the ground, taking care not to form loops, and to avoid placing the cables near or parallel to metallic conductors (cables, rails, fences, etc).

3. Connect the cables to terminals **H (Z)** and **S (Y)**, connect a cable between terminal **E (X)** and the earth electrode under test, then connect the clamp to terminal **ES (Xv)**. The device recognizes it automatically.

- Clamp to the path of the earth electrode to be checked, then connect a lead from the current clamp to this same point [connection to terminal **ES (XV)**]. Take care not to place the cable of electrode **H (Z)** too close to the current clamp in order to avoid any transmission of the AC signal to the clamp (especially when using an MN82 clamp).
- Start the measurement by pressing the **START/STOP** button.

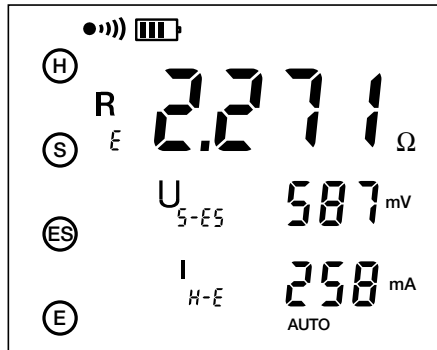
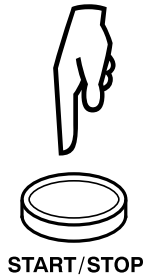

$$R_{SEL} = R_{E1}$$

- You can now move the clamp and its lead to measure the other earth resistances, R_{E2} , R_{E3} , etc.
- To display the measurement parameters, press **DISPLAY** several times.

The device displays the following parameters:

R_{SEL} , U_{S-ES} , I_{H-E} , R-Act (R_{PASS}), U-Act (U_{H-E} and its frequency), I-Act (I_{ES} and its frequency).

To measure the resistances of auxiliary electrodes **H (Z)** and **S (Y)**, or if the resistance of the electrodes is too large (see § 10.1), start the measurement with a long press of the **START/STOP** button.

R_E , R_H , R_S , U_{E-S} will be displayed.

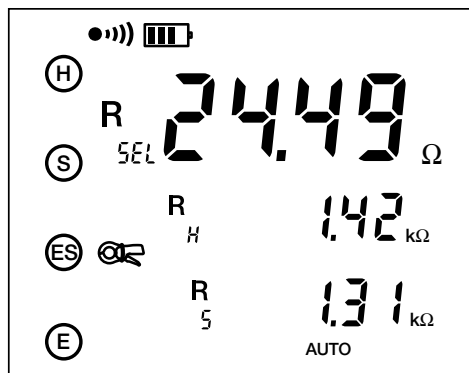
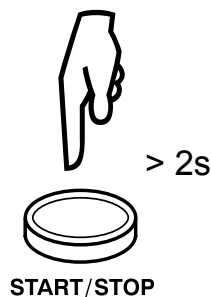

5.6 Soil Resistivity Measurements (ρ Position)

To measure the resistivity of the soil, two measurement methods are possible: **Wenner** and **Schlumberger**

The difference between the two methods lies in the positioning of the electrodes. By default, the device selects the Wenner method. The Schlumberger method, which allows you to move only 2 measurement electrodes rather than 3, is better suited for measuring soil resistivity at multiple depths.

The soil resistivity measurement with different distances **d**, and therefore in different layers (in depth) of the soil, can be used to establish resistivity profiles of the soil in question, which can be useful for geological analysis, the exploration of deposits, hydrological studies, etc., and to determine the location of an earth electrode.

5.6.1 Advantages and Disadvantages of Wenner and Schlumberger

Schlumberger		Wenner	
Advantage	Disadvantage	Advantage	Disadvantage
Need to move the two potential electrodes ES (Xv) and S (Y) only for most readings. This can significantly decrease the time required to acquire a sounding			All four electrodes, the two current E (X) and H (Z) and the two potential ES (Xv) and S (Y) must be moved equally to acquire each reading.
	Because the potential electrode spacing is small compared to the current electrode spacings, higher meter sensitivity is required.	Potential electrode spacing increases as current electrode spacing increases. Less sensitive meters may be used.	
Because the potential electrodes remain in fixed locations, the effects of the near surface lateral variations in resistivity are reduced.			Because all electrodes are moved for each reading, this method can be more susceptible to near-surface, lateral, and variations in resistivity. These near surface lateral variations could potentially be misinterpreted in terms of depth variations in resistivity.
	In general, interpretations based on DC soundings will be limited to simple, horizontal; layered structures		In general, interpretations based on DC soundings will be limited to simple, horizontal; layered structures.

Source: DC Resistivity - T. Boyd

5.6.2 Changing the Measurement Method

1. Set the switch to ρ .
2. Press the **Hz/OPTIONS** button. "AUTO" will blink.

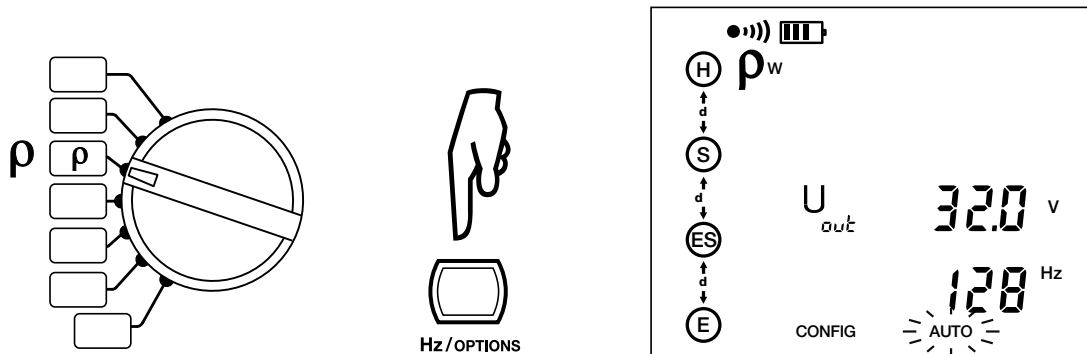

3. Press the **Hz/OPTIONS** button again. "W" will blink.
4. Press the \blacktriangleright button to change to the Schlumberger method.
5. To confirm and exit, press the **Hz/OPTIONS** button twice.

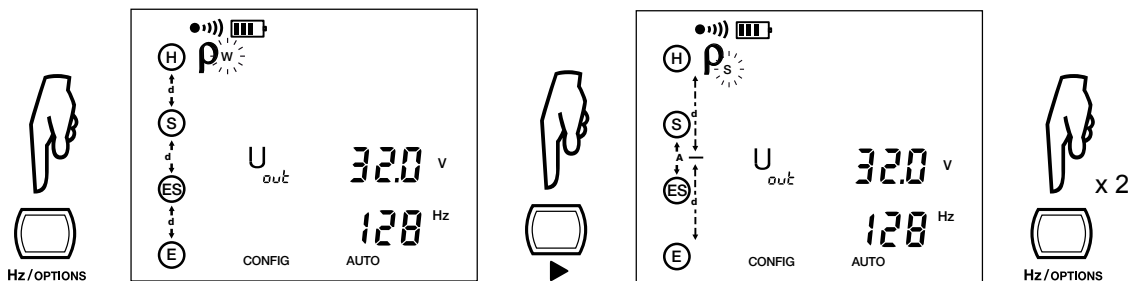

To switch back to the Wenner method, simply repeat this procedure.

The last measurement method selected (Wenner or Schlumberger) is stored in memory when the device is switched off.

5.6.3 Programming the Distance for Electrode Placement

The distance can be programmed before or after the measurement. If it is not programmed, only the value of R_{S-ES} will be displayed, since the value of ρ remains indeterminate.

1. Set the switch to ρ .
2. Press the **2nd** button, then the **DISTANCE** button. The "hundredths" will blink.

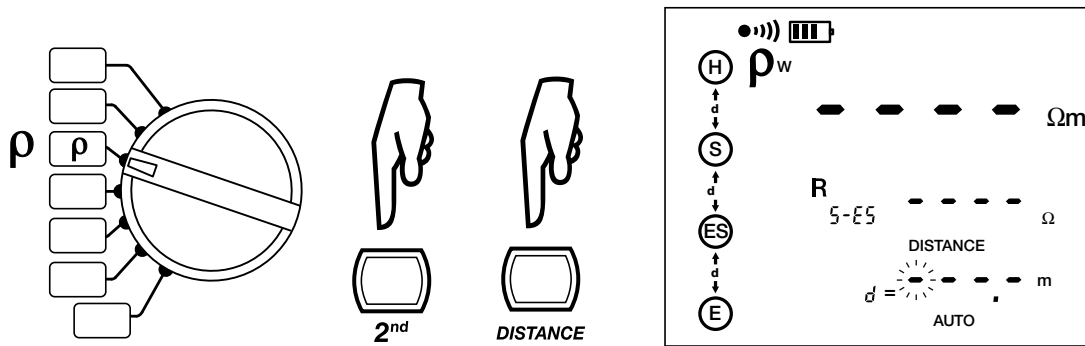

3. To modify the hundredths (of meters or feet), press the ▲ button until the desired digit is displayed (0-9).
4. To select and modify the tens, press the ► button and then the ▲ button until the desired digit is displayed (0-9).
5. To select and modify the units and tenths of a unit, press the ► button and then the ▲ button until the desired digits are displayed (0.0-9.9).
6. To terminate the programming of distance, press the **2nd** button and then the **DISTANCE** button.

In the case of the Schlumberger method, it is also necessary to program distance **A**. This is done in the same way as for distance **d**.

5.6.4 Wenner Method

1. Set the switch to ρ .
2. Place the 4 earth electrodes on a straight line, at a distance **d** from one another and at a depth $p < 1/20 d$. Distance **d** must be between 2 and 30m.
3. Connect the cables to the electrodes, then to terminals **H (Z)**, **S (Y)**, **ES (Xv)**, and **E (X)** in sequence.
4. Program the distance into the instrument as described in § 5.6.3.

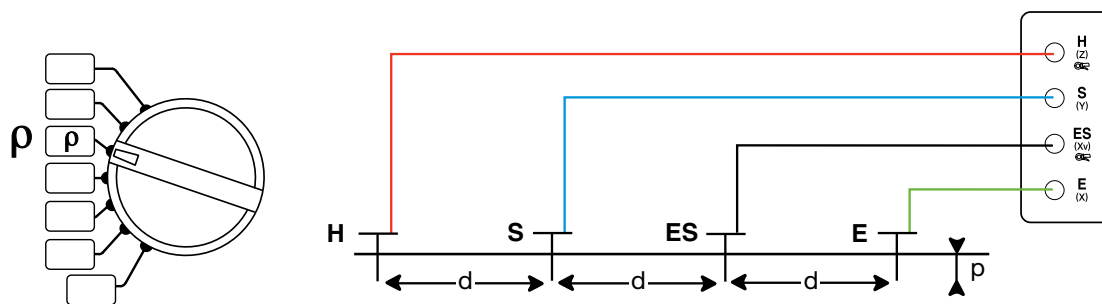

In order to avoid electromagnetic interference, it is best to unwind the full length of each cable from the reel, to keep the cables as far apart as possible on the ground,

taking care not to form loops, and to avoid placing the cables near or parallel to metallic conductors (cables, rails, fences, etc.).

5. Start the measurement by pressing the **START/STOP** button.

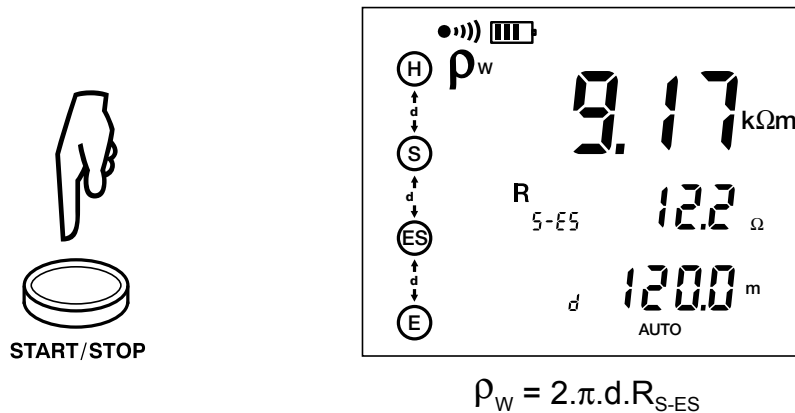

To display the measurement parameters, press **DISPLAY** several times.

The device displays the following parameters:

ρ_w , R_{S-ES} , d , U_{S-ES} , I_{H-E} , U_{Act} (U_{S-ES} and its frequency, U_{H-E} and its frequency).

To measure the resistances of the auxiliary electrodes **H (Z)**, **S (Y)**, **ES (Xv)** and **E (X)**, or if the resistance of the electrodes is too high (see § 10.1), start the measurement by a long press of the **START/STOP** button.

R_{P-E} and R_{P-H} , then R_{P-ES} and R_{P-S} will be displayed.

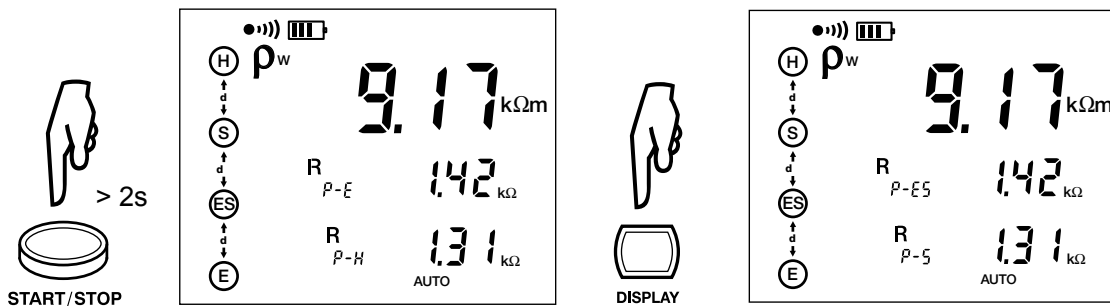

5.6.5 Schlumberger Method

1. Set the switch to ρ .
2. Place electrodes **S (Y)** and **ES (Xv)** at a distance **A** apart, then place electrodes **H (Z)** and **E (X)** in the same straight line, at a distance **d** measured from the midpoint of distance **A**. Distance **d** must be between 2 and 30m.
3. Drive the electrodes to a depth **p** of not more than **1/20 of d**.
4. Connect the cables to the electrodes, then to terminals **H (Z)**, **S (Y)**, **ES (Xv)**, and **E (X)**.

5. Program the distance into the instrument as described in § 5.6.3.

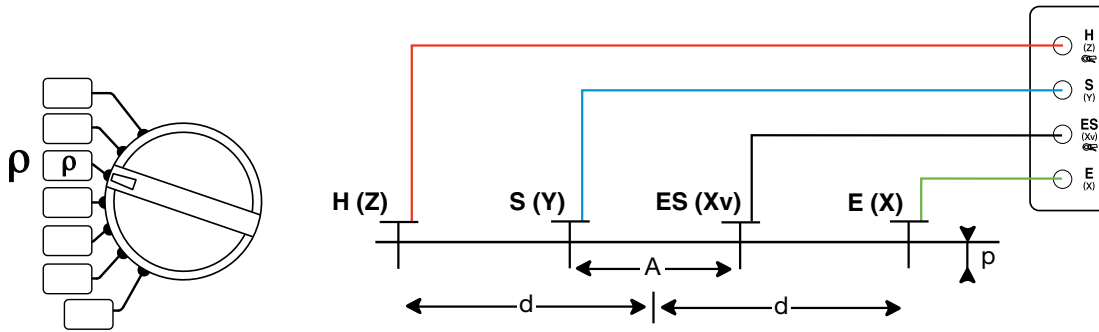

In order to avoid electromagnetic interference, it is best to unwind the full length of each cable from the reel, to keep the cables as far apart as possible on the ground, taking care not to form loops, and to avoid placing the cables near or parallel to metallic conductors (cables, rails, fences, etc.).

6. Start the measurement by pressing the **START/STOP** button.

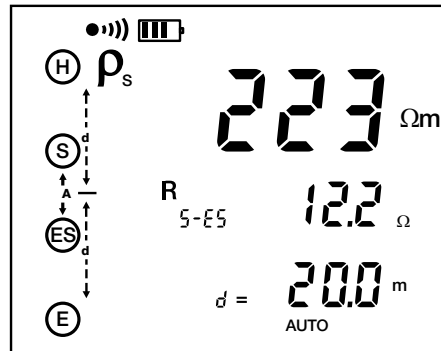

$$\rho_s = \pi \cdot \frac{d^2 - \frac{A^2}{4}}{A} \cdot R_{S-ES}$$

To display the measurement parameters, press **DISPLAY** several times.

The device displays the following parameters:

ρ_s , R_{S-ES} , d , U_{S-ES} , I_{H-E} , U_{Act} (U_{S-ES} and its frequency, U_{H-E} and its frequency).

To measure the resistances of the auxiliary electrodes **H (Z)**, **S (Y)**, **ES (Xv)**, and **E (X)**, or if the resistance of the electrodes is too high (see § 10.1), start the measurement by a long press of the **START/STOP** button.

R_{P-E} and R_{P-H} , then R_{P-ES} and R_{P-S} will be displayed.

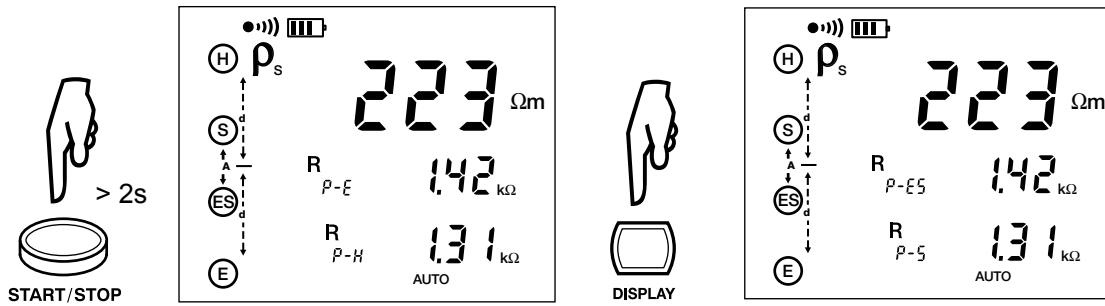

5.7 Earth/Ground Measurements with Two Clamps

This is a quick way to measure the value of the earth.

NOTE: The two clamp method typically yields a measurement higher than the fall of potential method since it uses a higher frequency to perform the test, resulting in an impedance measurement.

The current clamp connected to terminal **H (Z)** applies a voltage to the circuit to be measured. The value of the resulting current is determined by the impedance of the circuit to be measured. The current flowing in the loop is measured using the clamp connected to terminal **ES (Xv)**. The device then calculates loop resistance R_{LOOP} from these quantities.

NOTE: Use only SR182 or MN82 current clamps, which are specially designed to operate with the Model 6471.

1. Set the switch to .
2. Connect a clamp to terminal **H (Z)** and clamp it to a point down stream from the rod under test that is a serial path to the earth.
3. Connect the other clamp to terminal **ES (Xv)** and clamp it to the rod or electrode system to be measured.

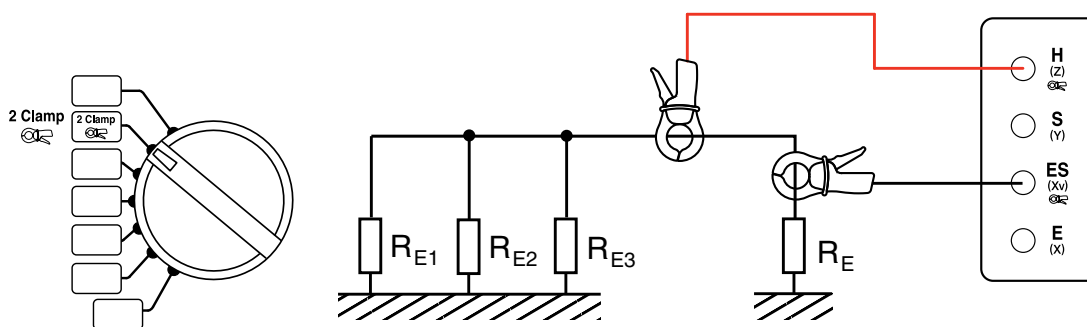

Observe the following minimum distances between the two clamps in order to avoid direct electromagnetic influences between the transmitting clamp and the receiving clamp:

Value measured (Ω)	Minimum separation	
	MN82	SR182
0 to 1	0.1m (4")	0m (0")
1 to 5	0.4m (1' 04")	0.1m (4")
5 to 10	0.5m (1' 08")	0.2m (8")
10 to 50	0.7m (2' 04")	0.3m (1')
50 to 100	0.9m (3')	0.5m (1' 08")
100 to 500	1.2m (4')	0.5m (1' 08")

1. Start the measurement by pressing the **START/STOP** button.

In the case of the diagram below, the earth impedance measured is equal to:

$$R_{\text{LOOP}} = R_E + (R_{E1} // R_{E2} // R_{E3})$$

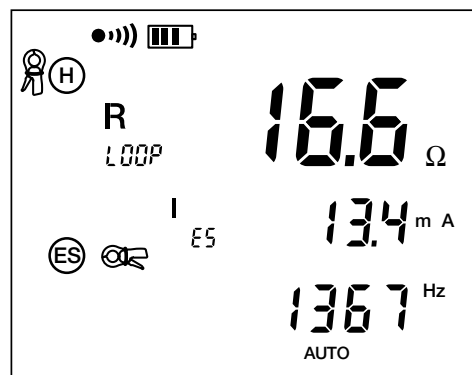
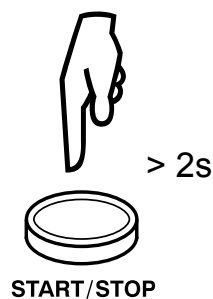

NOTE: In the AUTO mode, the measurement frequency is 1611Hz. To make an earth measurement that is free of inductive effects, you must change to MANUAL mode and choose a lower measurement frequency (see §6.2).

MANUAL MODE

All of the measurement functions described in § 5 (**AUTO mode**) can be performed in **MANUAL** mode if necessary.

To access **MANUAL** mode:

- Press the **Hz/OPTIONS** button once. The **Hz/OPTIONS** symbol appears and the **AUTO** indicator blinks.
- Use the ► button to switch from **AUTO** to **MANUAL**.
- When the tester is in **MANUAL** mode you can press **Hz/OPTIONS** repeatedly to see various parameters that can be set, depending on the measurement function selected.

When a measurement is performed by a short or long press on the **START/STOP** button (the circular arrows  on the display will rotate), the measurement can be stopped by a second press of this button.

Whenever a new measurement function is selected, the device automatically changes back to **AUTO** mode.

6.1 Switching the Test Voltage

Available in all functions except mΩ and 2 Clamp.

If necessary, the test voltages can be switched to either 16 or 32V as follows:

- Press the **Hz/OPTIONS** button, then press it again to make the output voltage (Uout) blink.
- Use the ► button to switch to 16 or 32V, then press **Hz/OPTIONS** again.

This setting is retained when the unit is turned off.

6.2 Measurement Frequency Selection

If there are signals with a frequency that could interfere with the chosen test frequency, the **NOISE** symbol will appear.

While in **MANUAL** mode, change the frequency by pressing the **Hz/OPTIONS** button until the frequency flashes.

Press the ► button to choose the following frequencies:

- USr, 55, 92, 110, 119, 128 Hz (128 Hz is default).

To change the user frequency (USr), press the ▲▼ buttons (▲▼ raises the value, and 2nd + ▲▼ lowers it).

Table of possible USr frequencies (48 values from 41 to 513Hz):

41	43	46	49	50	55	60	61	64	67	69	73	79	82	85	92
98	101	110	119	122	128	134	137	146	159	165	171	183	195	201	220
238	244	256	269	275	293	317	330	342	366	391	403	439	476	488	513

There are two user frequencies: one for resistivity and one for earth and soil potential measurements. These two values remain in memory even after the device is switched off.

For soil resistivity measurements, the user frequency is limited to 128 Hz.

6.3 Manual Settings for mΩ Measurements

Pressing **Hz/OPTIONS** in **MANUAL** mode allows the following parameters to be changed using the ► button:

- Terminal symbols H and E blink → H S ES E blink (4-Pole measurement)
- POS on H and DC+ blinks → neg on H and DC- (reversal of polarity at terminal H)

In **MANUAL** mode the tester does not reverse polarity automatically during the measurement; however, the polarity can be reversed during the measurement by pressing the **Hz/OPTIONS** button.

6.3.1 Continuity Test

The 2-wire mΩ measurement gives a quick measurement result, accompanied by an audible beep, during a continuity check.

The display is in the sensitivity range (0.5Ω to 1.99kΩ) and the terminal check is limited to terminal **H (Z)** (a cable must be connected to it), making it possible to start the measurement with an open circuit.

For a continuity check, the following settings are mandatory:

- The 2-wire mΩ measurement function must be selected.
- The device must be in manual mode.
- The alarm function must be active (On).
- The alarm threshold must be low (<).
- The buzzer must be activated (bBEEP On).

6.4 3-Pole Earth/Ground Measurements & Coupling

6.4.1 3-Pole Earth/Ground Measurements

Pressing on **Hz/OPTIONS** in **MANUAL** mode allows the following parameters to be changed using the ► button:

- EARTH blinks → Earth Coupling Measurement
- 128 Hz blinks → Test Frequency Measurement
- Test voltage blinks → Test Voltage Selection

6.4.2 Earth/Ground Coupling Measurements

This measurement calls for making and storing three intermediate measurements (at the same frequency). It is available only in **MANUAL** mode.

Connection diagram:

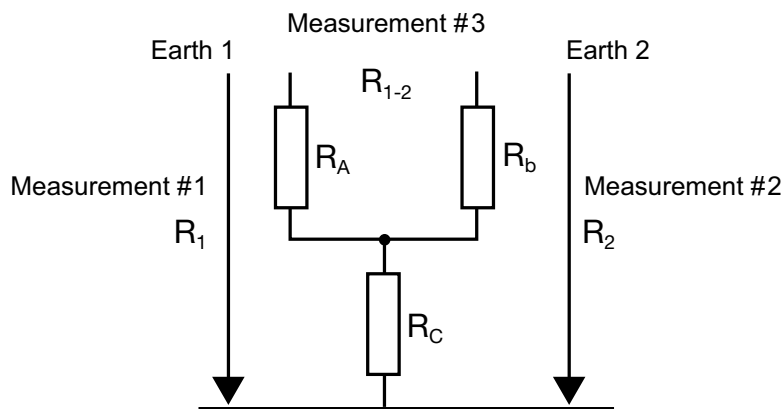

Press **Hz/OPTIONS** and use the ► button to switch from **EARTH** to **EARTH COUPLING**. Proceed as follows:

- If you want to eliminate the resistance of the measurement leads, you can use lead compensation (**2nd + START**) before starting the actual coupling measurement (see § 5.2.1).
- Turn the rotary switch to 3-Pole.
- Select a test frequency and a test voltage (if desired).
- The screen displays **EARTH COUPLING 1**. Make a 3-pole earth measurement on the first earth system (measurement of R_1 in the connection diagram on previous page).
- Stop the measurement by pressing the **START/STOP** button. The **MEM** symbol flashes to indicate that this result must be recorded in memory. Press the **MEM** button twice. To save to another location, refer to §7.1.

- The screen now displays **EARTH COUPLING 2**. Make a 3-pole earth measurement on the second earth system (measurement of R_2). For this second measurement, leave the **H (Z)** and **S (Y)** electrodes in the same positions as for the first measurement.
- Store this result in the same memory location as before by pressing the **MEM** button twice.
- The screen now displays the message **EARTH COUPLING 3**. Disconnect terminal **S (Y)** and make a 2-wire resistance measurement with terminal **H (Z)** connected to earth 1 and terminal **E (X)** to earth 2.
- Record this result by pressing the **MEM** button twice.
- **EARTH COUPLING 4** and the results of the measurements are displayed.

The calculation is based on the following formulas:

$$R_C = (R_1 + R_2 - R_{1-2})/2$$

$$C_1 = R_C/R_1 \text{ and } C_2 = R_C/R_2 \quad R_A = R_1 - R_C$$

$$R_b = R_2 - R_C$$

- To display all of the measurement parameters, press the **MR** button.
- To scroll through all of the measurements, use the **▶** and **▲** buttons.

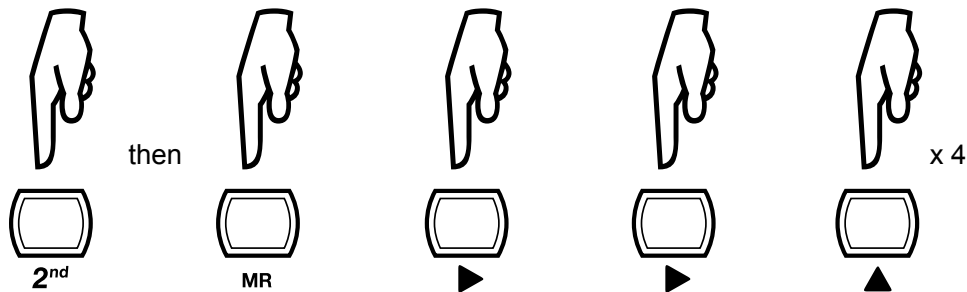

Press **DISPLAY** several times to display the following parameters:

EARTH COUPLING 1	R_1 , U_{OUT} and frequency, U_{S-E} , I_{H-E} , U_{-ln} (U_{S-E} and frequency) R_H and R_S if long press of START/STOP
EARTH COUPLING 2	R_2 , U_{OUT} and frequency, U_{S-E} , I_{H-E} , U_{-ln} (U_{S-E} and frequency) R_H and R_S if long press of START/STOP
EARTH COUPLING 3	R_{1-2} , U_{H-E} and frequency, I_{H-E} , U_{-ln} (U_{H-E} and frequency).
EARTH COUPLING 4	R_C , C_1 , C_2 , R_A , R_b , U_{out} and its frequency.

6.5 4-Pole Earth/Ground Measurements

Pressing the **Hz/OPTIONS** button allows the following parameters to be changed using the ► button:

- 128Hz blinks → Change the test frequency
- Test voltage blinks → Switch between 16 and 32V

6.6 Soil Resistivity Measurements

Pressing the **Hz/OPTIONS** button allows the following parameters to be changed using the ► button:

- ρ_W blinks (Wenner method) → Switch to ρ_S (Schlumberger method)
- 128Hz blinks → Change the test frequency
- Test voltage blinks → Switch between 16 and 32V

6.7 Measurements with Two Clamps

Pressing the **Hz/OPTIONS** button allows the following parameters to be changed using the ► button:

- 1611Hz blinks → Change the test frequency

6.8 Smoothing

In the manual mode, you can activate or deactivate the smoothing of the measurement results by pressing the **2nd + DISPLAY (SMOOTH)** buttons. This smoothing consists in displaying an exponential mean value, a significant help with highly fluctuating values.

MEMORY FUNCTION

The instrument has a total of 512 memory locations. Each of these locations is defined by an object number (OBJ) from 01 to 99 and by a TEST number from 01 to 99.

For 3- and 4-pole earth measurements, the sweep mode (SWEEP) can record several measurement results at the same memory location, with the frequency as third addressing criterion.

During soil potential or resistivity measurements (Wenner or Schlumberger methods), several measurement results are recorded at the same memory location, with the distance between electrodes as the third addressing criterion.

For earth coupling measurements (EARTH COUPLING 1, 2, 3, 4), the four measurements provide the third addressing criterion for the same memory location.

None of the other measurements has an additional addressing criterion, so each occupies only one memory address.

Since each measurement is dated, you must set the date and time of the device before any storage in memory (see § 4.2).

7.1 Saving Measurements into Memory

Measurement results can be saved by performing the following:

- Press the **MEM** button. The tester will automatically suggest the next free memory location (FrEE message).
- Press the **MEM** button a second time to save to the OBJ/TEST location.
- If you decide not to save your results, press **DISPLAY** to exit MEM mode.
- To change the OBJ and TEST location, use the ► and ▲▼ buttons.

NOTE: If a memory location is already occupied, the message  will be displayed. Pressing the **MEM** button will overwrite the measurement record.

For soil resistivity and potential measurements, if several measurements are made with different distances **d**, you can store them under the same OBJ:TEST number, with the distance as third addressing criterion.

It will be possible to overwrite values already stored with new ones having the same distance **d**, or even to add new results having other values for the distance **d** provided that all of the other measurement parameters are identical.

7.2 Recalling Measurements from Memory

To recall saved measurements, perform the following:

- Select a measurement function, then press the **2nd** and **MR** buttons.
- Use the **▶** and **▲▼** buttons to choose the OBJ and TEST numbers.
- Press the **DISPLAY** button to display the time (tiME) and date (dAtE).
- Press **DISPLAY** again to display the measurement and its parameters.
- Press the **MR** button again to exit the recall mode.

The SET-UP function lets you read all memory addresses one after the other independently of which measurement function is chosen.

Any measurement stored in the tester can be retrieved individually using Data-View[®] software (see § 8).

7.3 Erasing Measurements from Memory

There are two ways to erase measurements - complete and selective.

7.3.1 Erasing All Measurements

- Set the switch to SET-UP.
- Push once on the **MEM** button to display the number of free and available records.
- Push a second time on the **MEM** button.
- The display will show “**dEL ALL**”. Change the blinking **NO** to **YES** with the **▲** button, then perform a long press (>2s) on the **MEM** button.



WARNING: This will delete ALL saved records.

- To exit without erasing, perform a short press on the **MEM** button.

7.3.2 Erasing Selective Measurements

- Set the switch to SET-UP.
- Press the **2nd** button.
- Press the **MR** button. The Object and Test numbers of the last stored test appear, with the Object number blinking.

- If you need to change the Object number, press the ▲ button until the desired number is displayed. Then press the ► button; the Test number now blinks.
- Press the ▲ button until the desired test is displayed.
- Press the **MEM** button to display the **dEL** screen. By default, the blinking word **NO** appears on the screen, indicating the test is not to be deleted. To delete the test, press the ▲ button to change the blinking **NO** to **YES**, then press and hold down (>2s) the **MEM** button. To exit without erasing, perform a short press on the **MEM** button.

Note that if the test stored in this Object/Test number is a sweep test (which consists of multiple measurements taken at different frequencies) this procedure only deletes a single measurement. The remaining sweep measurements will still be stored in this Object/Test. You must delete all individual measurements to completely remove a sweep test.

When a test is deleted, its Object/Test number is removed from memory. When you subsequently view stored tests, this number will be skipped. This Object/Test number combination remains unavailable for storing tests until you completely erase memory, as instructed in Section 7.3.1.

DATAVIEW® SOFTWARE

8.1 Installing DataView®



DO NOT CONNECT THE INSTRUMENT TO THE PC BEFORE INSTALLING THE SOFTWARE AND DRIVERS.

NOTE: When installing, the user must have Administrative access rights during the installation. The users access rights can be changed after the installation is complete. DataView® must be reinstalled for each user in a multi-user system.

1. Insert the DataView thumb drive into an available USB port on your computer. If Autorun is enabled, an AutoPlay window appears on your screen. Click “Open folder to view files” to display the DataView folder. If Autorun is not enabled or allowed, use Windows Explorer to locate and open the USB drive labeled “DataView.”
2. When the DataView folder is open, find the file Setup.exe located in the root directory of the USB drive, and double-click it to run the installation program.
3. The DataView setup screen appears.

In the upper left corner of the screen, choose the language version of the Setup interface. (All Setup screens and dialogs will immediately appear in the selected language.)

In the lower left corner are the available installation options. In addition to the DataView software, you can select “Adobe Reader.” This links to the Adobe web site where you can download the latest version of Reader. This program is required to view DataView .pdf documents. The option Firmware Upgrades links to the website where you can check for new firmware updates for the instrument. Finally, User Manuals displays a list of .pdf files contained in the USB drive that accompanies DataView. (DataView also comes with a Help system that is installed with the program files.)

To install DataView, select DataView in the Options list and click Install.

4. Select the language version of DataView you want to install (English, French, or Spanish) then click Next. (By default, the language selected in step 3 is highlighted.)
5. You are now prompted to select the software you want to install. Each AEMC product family has its own specially designed Control Panel. If you are performing a Complete install, by default all available Control Panels are selected (a check mark next to the Control Panel indicates it is selected). Control Panels take up disk space on the computer; so unless you have other types of AEMC instruments, we recommend that you select Ground Tester and deselect the rest. You should also check the option DataView Core, which is a requirement if you plan to create DataView reports.

After you finish selecting and deselecting Control Panels and/or DataView Core, click Next.

6. The Setup program now informs you that it is ready to install DataView. If you want to review any of your previous selections, click the Previous button to return to earlier screens. Otherwise, click Install to begin installation.
7. The InstallShield program installs the selected software. If an earlier version of the software is already installed on your computer, for each selected program the InstallShield program will:
 - (a) Ask you to confirm the installation of the program. Click Next.
 - (b) Display a status bar indicating the progress of the installation.
 - (c) Inform you when the program is installed. Click Finish to install the next selected program.

If the software is not installed (or if the installed software is the same version as the selected software), the software is installed without requesting confirmation.

When all programs are installed, a message appears informing you of this. Click Finish to return to the Setup screen.

8. You can now select additional Setup options to install (see step 3 above). When finished, click Exit.
9. The DataView folder now appears on your computer desktop, within which is the Ground Tester  icon and the icon(s) for any other Control Panel(s) you have installed.

8.2 Ground Tester Control Panel

Clicking the DataView icon in the DataView folder on your desktop opens the core DataView program. Clicking the Ground Tester Control Panel icon opens the Ground Tester Control Panel.

In general, core DataView features are for creating, viewing, editing, and storing DataView reports; while the Control Panel is for connecting to, configuring, viewing measurements on, and downloading data from the instrument. You can access all DataView features through either the DataView icon or the Control Panel icon. For users who interact with ground tester instruments, we recommend primarily using the Control Panel. However, there are situations where using the core DataView icon may be more convenient for some users, such as when viewing multiple archived reports from different AEMC product families.

For further information about using the Ground Tester Control Panel, consult the Help system that comes with the product. Access this Help by clicking the option Help in the Control Panel's menu bar at the top of the screen.

MAINTENANCE

9.1 Maintenance



Please make sure that you have read and fully understand the **WARNING** section on page 3.

- To avoid electrical shock, do not attempt to perform any servicing unless you are qualified to do so.
- To avoid electrical shock and/or damage to the instrument, do not get water or other foreign agents into the case.
- Turn the instrument OFF and disconnect the unit from all circuits before opening the case.
- Use specified spare parts only.

9.2 Cleaning



Disconnect the instrument from any source of electricity.

Use a soft cloth lightly moistened with soapy water. Wipe with a moist cloth and then dry with a dry cloth. Never use alcohol, solvents or hydrocarbons.

9.3 Fuse Replacement

The unit is protected from overloads by two identical fuses:

- **Fuse for terminal H (Z):**

If this fuse is defective, the unit will no longer produce an output voltage, making it impossible to perform resistance measurements.

To test this fuse, turn the switch to the $m\Omega$ position (2-Wire), connect measurement leads to terminals **H (Z)** and **E (X)** and start a measurement. If the unit refuses to operate and the symbol for terminal **H (Z)** blinks, the fuse must be replaced.

- **Fuse for clamp terminal ES (Xv):**

If this fuse is defective, the unit will no longer recognize a clamp that is connected to terminal **ES (Xv)**, making it impossible to perform a 4-Pole earth measurement with a clamp or an earth measurement with 2 clamps.

To test this fuse, select the 4-Pole measurement function and connect a test clamp to terminal **ES (Xv)**. If a clamp symbol does not appear next to the symbol for terminal **ES (Xv)** in the display, the fuse must be replaced.



NOTE: For safety reasons this fuse must always be replaced by an identical model: 0.63 A F 250V 5x20mm 1.5kA (Cat. #2135.81)

Procedure for replacing fuses:

1. Disconnect the unit completely, turn the rotary switch to OFF, and close the lid.
2. Loosen the four permanent screws at the bottom of the unit, but do not remove them.
3. Open the lid and carefully turn the housing upside-down, making sure the front panel does not fall out. Then carefully pull the front panel and the unit all the way out of the housing.
4. The fuse for terminal **H (Z)** is accessible at the back of the unit (in the corner near the terminal for the battery charger).
5. If only the fuse for terminal **H (Z)** needs to be replaced, jump ahead to step 13. To replace the fuse for the clamp terminal **ES (Xv)**, continue on.
6. Loosen the two screws on the lid of the battery case and remove the lid.
7. Pull the battery a short way out of the case without overstressing the connection leads, and loosen the two screws at the bottom of the case. Then put the battery back into the case.
8. Making sure the battery leads are not overstretched and that the battery does not fall out, carefully lift off the back of the unit, turn it over and place it next to the front panel with the electronic components.
9. The fuse for the clamp terminal **ES (Xv)** is now accessible on the printed circuit board [in the corner near terminal **E (X)**]. When replacing the fuse, avoid touching the circuitry or components.
10. Return the back of the unit to the front panel with the components, taking care not to stretch the battery leads. Carefully lower the back of the unit and make sure that it is aligned correctly (the four cylindrical holes on the back must slip over the four mounting pins on the front panel). Also make sure you do not pinch the battery leads or other wires or components.

11. Pull the battery a short way out of the case without overstretching the connection leads, and retighten the two screws at the bottom of the case. Then put the battery back into the case.
12. Put the lid back onto the battery case and screw it shut.
13. Wipe off any dirt on the seal and housing rim.
14. Put the unit back into the housing and screw it into place.

9.4 Recharging the Battery



NOTE: To make the best use of the battery and prolong its service life, observe the following rules.

- Use only the battery charger supplied with the unit; other chargers may be hazardous!
- Recharge the battery only at temperatures between 32° and 104°F (0° and +40°C).
- Observe the conditions of use and storage defined in the specifications.

Even an NiMH battery can be recharged only a limited number of times. This number, and thus the service life of the battery, is highly dependent on the following factors:

- the operating conditions
- the recharging conditions

As the earth tester might go some time without use and the battery has a natural tendency to run down, you should check the battery level at regular intervals. To do this, turn on the unit and check the battery level indicator  at the top of the display. If there is only one bar in the symbol or if there are no bars at all, the battery should be recharged.

If the unit is not used for a long time, the battery might run down all the way. In this case, recharging can take several hours. In addition, the unit might not work properly at the start of recharging.

The capacity and lifetime of the battery may also be diminished. After about five charging/discharging cycles the battery will recover its initial capacity.

To recharge the battery, plug the charging unit into the connector at the upper left (connector ② in Fig. 2-1) and connect the charging unit to a 100 to 240VAC power source (suitable for Europe and the U.S.). The frame of the battery symbol will blink during charging. Charging goes faster when the tester is turned off. The battery voltage is shown on the large display next to Ubatt.

At the middle and bottom of the display you will see one of the following messages:

bAtt CHRg	Fast charging is active (normal state)
bAtt LOW	Battery voltage is too low for a fast charge - charging at a lower current
bAtt	Battery voltage is too high for a fast charge - charging at a lower current
bAtt HOT	Battery is too warm for a fast charge (>40°C) - charging at a lower current
bAtt COLd	Battery is too cold for a fast charge (<0°C) - charging at a lower current
bAtt FULL	Battery is full - switch to trickle charging

The 6471 tester can also be recharged from a 12VDC car outlet with a special charging unit.



NOTE: In this case the low-potential of the vehicle's 12V outlet is at the potential of terminals **E (X)** and **ES (Xv)** of the ground tester. For safety reasons, do not connect or use the unit if there is a possibility that voltages at **E (X)** or **ES (Xv)** could exceed 32V.

9.5 Replacing the Battery

The battery in this unit is a special product with customized safety features and protective devices. It should be replaced only by the same model. If a different model is used, there is a danger of fire or explosion, leading to possible damage or injury.



NOTE: For safety reasons, replace the battery with an identical model: NiMH Custom Pack 9.6 V / 3.5 Ah (Cat. #2960.21)

Procedure for replacing the battery:

1. Disconnect the unit completely, turn the rotary switch to OFF, and close the lid.
2. Loosen the four permanent screws at the bottom of the unit, but do not remove them.
3. Open the lid and carefully turn the housing upside-down, making sure the front panel does not fall out. Then carefully pull the front panel and the unit all the way out of the housing.
4. Loosen the two screws on the lid of the battery case and remove the lid.
5. Pull the battery a short way out of the case without overstressing the connection leads, and loosen the two screws at the bottom of the case. Then put the battery back into the case.
6. Making sure the battery leads are not overstretched and that the battery

does not fall out, carefully lift off the back of the unit, turn it over and place it next to the front panel with the electronic components.

7. Press the clip off the plug, and pull out the plug with the four battery leads (in the corner, near the terminal for the optical interface). Avoid touching the circuitry or components.
8. Remove the old battery from the case and put in a new one. Run the leads with the plug through the largest slot in the battery case.
9. Insert the battery plug (in the corner, near the terminal for the optical interface). The two pins should point towards the clip. Avoid touching the circuitry or components.
10. Return the back of the unit (with the new battery in the case) to the front panel with the components, taking care not to stretch the battery leads. Carefully lower the back of the unit and make sure that it is aligned correctly (the four cylindrical holes on the back must slip over the four mounting pins on the front panel). Also make sure you do not pinch the battery leads or other wires or components.
11. Pull the battery a short way out of the case without overstretching the connection leads, and retighten the two screws at the bottom of the case. Then put the battery back into the case.
12. Put the lid back onto the battery case and screw it shut.
13. Wipe off any dirt on the seal and housing rim.
14. Put the unit back into the housing and screw it into place.
15. Fully charge the new battery in the unit before using it.
16. Reset the time and date.



NOTE: If the instrument is not used for long periods of time (more than 6 months), it is recommended, in order to recover the initial capacity of the battery, to make several charge-discharge cycles (3 to 5 times). Discharge cycle (15 H) can be made with the instrument in **MANUAL** mode, DC 2-Pole (2-Pole) resistance measurement and a short-circuit between **H (Z)** and **E (X)** plugs.

TROUBLESHOOTING

10.1 Error Reporting



10.1.1 Electrode Resistance Too High



This can happen in a 3- or 4-pole earth measurement, a resistivity measurement, or an earth potential measurement.

This message is displayed when the measurement is triggered by a short press of the **START/STOP** button and the resistances of the auxiliary electrodes are too high.

The measurement must then be started by a long press on the **START/STOP** button. The device then measures the values of the electrodes and compensates for them to display the correct result.

10.1.2 Out of Range

 or  The flashing > or < symbol indicates the measurement is out of range.

 and  If both symbols flash together, it means that the accuracy of the value displayed is outside of the instrument specification or is subject to large fluctuations. Activating the smoothing function (SMOOTH) may correct this. Press the **2nd** button, then the **SMOOTH** button to activate smoothing.

10.1.3 Misconnection

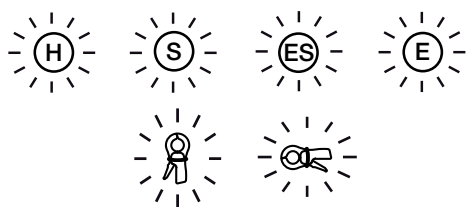

This flashing indicates that a terminal or a current clamp needs to be either connected or disconnected. You must correct the connections or the measurement will not proceed. The flashing of terminal H may also indicate that current I_{H-E} is too low. The flashing of terminal S may also indicate that resistance R_S is too high. The flashing of terminal ES may also indicate that the current I_{ES} measured by the clamp is too low.

To reduce R_H , you can add one or more electrodes, 2 meters apart from each other, in the **H (Z)** leg of the circuit, or increase the test voltage.

To reduce R_S , you can add one or more electrodes, 2 meters apart from each other, in the **S (Y)** leg of the circuit.

To reduce the resistance of the electrodes, you can also drive them deeper, pack the ground around them well, or dampen them with water.

10.1.4 Out of Limits Indicators



This flashing during a **passive** measurement means that the device has detected the presence of an external voltage exceeding 42V on the terminals and that the measurement is impossible.



This flashing during an **active** measurement means that the operating limits have been exceeded.



If this symbol remains lit during an active measurement, it means that the values measured are subject to large fluctuations or that there is an incorrect connection.

NOISE











The display of an indefinite value for a passive measurement indicates that measurement current I_{ES} or I_{SEL} or voltage U_{S-ES} is too low.

The display of the NOISE symbol indicates that a stray external voltage is likely to interfere with the measurement. You should change to manual mode and change the measurement voltage and/or frequency in order to make a valid measurement.

After the measurement has started there are indicators of when:

- Values R_H and/or R_S are too high,
- Measurement current I_{H-E} , I_{ES} or I_{SEL} is too low,
- The instability of the measurement is large.

Conditions that may give uncertain results are indicated on the display of the unit as follows:

Frequency	Function	Triggering threshold	Indication on the display unit
f > 513Hz	3P, 4P, V pot.	$I_{H-E} < 6 \text{ mA}$	 flashes ⁽³⁾  flashes
	4Psel	$I_{H-E}' < 6 \text{ mA}^{(1)}$	
f ≤ 513Hz	3P, 4P, ρ, V pot	$I_{H-E} < 1 \text{ mA}$	 flashes
	4Psel	$I_{H-E}' < 1 \text{ mA}^{(1)}$	
f > 513Hz	All (except ρ and 2 clamps)	$R_s > 5 \text{ k}\Omega$	 flashes ⁽³⁾  flashes
f ≤ 513Hz	All	$R_s > 30 \text{ k}\Omega$	
	4P sel	$I_{ES} < 1 \text{ mA}$	 flashes ⁽³⁾  flashes
	All	Values measured (U, I, R) unstable, varying by more than 5% about their mean values. ⁽²⁾	 steady ⁽³⁾  flashes
	R_{PASS}	$I_{ES} < 3 \text{ mA}$ $I_{SEL} < 30 \text{ mA}$ $U_{S-ES} < 10 \text{ mV}$	 flashes
	R_{PASS}	$I_{ES} < 0,3 \text{ mA}$ $I_{SEL} < 3 \text{ mA}$ $U_{S-ES} < 1 \text{ mV}$	-.--- (undefined)
	All	$U_{S-ES}, U_{S-E}, U_{H-E} > 42 \text{ V}$	 flashes ⁽³⁾
	All	Stray voltage of which the frequency and/or value is likely to interfere with the measurement.	NOISE ⁽⁴⁾

(1) I_{H-E}' : current I_{H-E} measured at the start of the measurement before I_{SEL} .

(2) Not active if the SMOOTH function is selected.

(3) The  symbol may also appear if there is an external voltage > 42 V on the terminals of the device.

(4) You should change to manual mode and modify the measurement voltage and/or frequency to make a valid measurement (when the NOISE symbol is no longer illuminated).

10.1.5 Error Messages

When started up, the Model 6471 device automatically performs a self-test. If a fault appears during this self-test or during a measurement, the device displays a message in the form Err XX.

There are 3 categories of errors:

- **Harmless** Errors **6, 7, 11** and **17**
The message appears for approximately 1 second to inform the user. Consider a repair if the error recurs.
 - Errors **6** and **7** are always preceded by an automatic reset.
 - During Error **11**, the tester automatically resets to the factory default settings.

- **Correctable** Errors **5, 9, 14, 15, 18, 19, 30, 31, 32** and **33**
These errors concern the current measurement function and disappear if the function is changed. The device can therefore be used, but a repair will be necessary if the error persists.
 - Error **18** indicates that the rechargeable battery in the tester cannot be recharged. If this error occurs during recharging, disconnect the tester from the charger and follow the procedure described in the “fatal” errors.
 - Error **19** can be corrected by clearing the entire memory of the unit (see section 8.3).
 - Errors **31, 32** and **33** indicate excessive voltage or excessive current during a measurement. Check the measurement setup for faults.

- **Fatal** Errors **0, 1, 2, 3, 8, 12, 13, 15, 16, 18** (during battery recharge) and **21**
These errors make operation of the unit impossible. Turn off the unit and turn it on again. If the error persists, repair is necessary.

GLOSSARY OF TERMS

Basic Terminologies

Explanations for some of the basic terms related to earth measurements follow:

Auxiliary electrode - H (Z)

A supplementary electrode through which a measurement current flows.

Earth conductor

The conductor which connects the installation to be earthed to the earth electrode.

Earth connection

A locally restricted group of electrically connected earth contacts. It also includes metal parts of installations such as pylon footings, bracings, cable sheathing and earth conductors.

Earth electrode - E (X)

A conductor which is buried in the earth and makes electrical contact with it.

Earth potential

The potential difference measured between the earth connection and a reference earth electrode.

Earth electrode - ES (Xv)

A connection on the earth electrode or earthing system used for measuring the potential of the earth electrode.

Earth resistance

The resistance measured between the earth connection and a reference earth electrode (cf. selective earth resistance).

Earth

The location of an earth connection (see also reference earth).

Earthing system

The set of all installations connected to the earth.

Electrode - S (Y)

An auxiliary electrode used for measuring the potential of the reference earth. The voltage, which is proportional to the resistance of the earth connection, is measured between this electrode and the earth electrode.

Reference earth

The area of earth (especially at the surface) which is outside the range of influence of the earth electrode or earthing system.

Resistivity of the earth (ρ)

Resistivity is defined as the resistance from wall to opposite wall of a cubic meter of soil. It is measured in ohm-meters (Ωm).

Selective earth resistance

The parallel partial resistance of an earth connection or earthing system. It is measured by selective measurements of current in the corresponding resistance branch. A selective earth resistance is always greater than the total earth resistance (parallel connection).

Step voltage

The potential difference bridged by a person who takes a step of 1m (approx. 3 ft), with the resulting current flowing through the body from one foot to the other (cf. touch voltage).

Supplementary electrode

An additional earth electrode (earth stake, earth rod).

Touch voltage

The potential difference which a person is able to bridge with his or her body, the resulting current being limited by the body and the local earth resistance (cf. step voltage).

The general term earth measurement can refer to measurements of individual earth electrodes, earth connections or entire earthing systems, depending on the object of interest.

Glossary

This glossary lists the terms and abbreviations used on the instrument and the digital display.

- 3-Poles** : measurement of earth resistance with 2 auxiliary stakes (3-Pole method)
- 4-Poles** : 4-Pole measurement of low earth resistance with 2 auxiliary stakes (4-Pole method)
- C_1** : earth coupling coefficient R_A with earth R_b ($C_1 = R_C / R_1$)
- C_2** : earth coupling coefficient R_b with earth R_A ($C_2 = R_C / R_2$)
- d, A** : distances to be programmed to calculate resistivity according to the measuring method used
- m Ω** : measurement of low resistance /continuity

E	: terminal E (X) - earth socket; current measurement return terminal
EARTH	: earth measurement (3 or 4 poles)
EARTH COUPLING	: coupling measurement between two earth sockets
ES	: ES (Xv) terminal (measurement potential socket for calculating earth resistance)
H	: H (Z) terminal (measurement current injection terminal)
I-Act ⁽¹⁾	: external current circulating at present between the instrument terminals
I_{ES}	: current measured by the clamp connected to the ES terminal (selective earth measurement with clamp)
I_{H-E}	: measurement current circulating between the H and E terminals
NOISE	: indicates the presence of external interference causing misrepresentation of the earth or resistivity measurement
R	: average resistance calculated from R+ and R-
R+	: resistance measured with a positive current circulation from terminal H to E
R-	: resistance measured with a negative current circulation from terminal H to E
R-Act ⁽¹⁾	: resistance currently calculated from values U-Act and I-Act
R₁	: first value measured to calculate the coupling between 2 earth sockets ($R_1 = R_A + R_C$)
R₂	: second value measured to calculate the coupling between 2 earth sockets ($R_2 = R_b + R_C$)
R₁₋₂	: third value measured to calculate the coupling between 2 earth sockets ($R_{1-2} = R_A + R_b$)
R_A	: first earth value calculated ($R_A = R_1 - R_C$)
R_b	: second earth value calculated ($R_b = R_2 - R_C$)
R_C	: coupling resistance between earths R _A and R _b ($R_C = (R_1 + R_2 - R_{1-2}) / 2$)
R_E	: earth resistance connected to terminal E
R_H	: resistance of the stake connected to terminal H
R_{LOOP}	: resistance of the earth loop measured with the "2 clamps" function
R_{PASS}	: value of the R-Act resistance (PASS for "passive" measurement with interference current circulating in the

	installation)
R_S	: resistance of the stake connected to terminal S
R_{SEL}	: selective earth resistance (measurement of the current with a clamp)
$R_{S-ES}^{(2)}$: resistance between stakes S and ES (used for resistivity measurement)
$R_{\Delta 0}$: measuring lead compensation resistance
S	: S (Y) terminal (reference potential socket for calculating earth resistance)
U-Act ⁽¹⁾	: external voltage currently present on the instrument terminals
U_{H-E}	: voltage measured between terminals H and E
U_{OUT}	: voltage generated by the instrument between terminals H and E (32V or 16V)
U_{S-E}	: voltage measured between terminals S and E
U_{S-ES}	: voltage measured between terminals S and ES
U_{SR}	: frequency chosen by the user
U_{SrEL}	: voltage of terminal S (compared with E) expressed as a relative value (rEL); value without unit
V pot.	: ground potential measurement
ρ_S	: ground resistivity measured according to the Schlumberger method (expressed as $\Omega.m$)
ρ_W	: ground resistivity measured according to the Wenner method (expressed as $\Omega.m$)

(1) The suffix **Act** becomes **In** (for "Input" in English) when this value is recorded by the instrument and then read, to make a distinction between the current and recorded values. In both cases, this value on the display is associated with its frequency.

(2) In this case, the resistances of the 4 stakes used for measurement are indicated by R_{P-H} , R_{P-S} , R_{P-ES} , R_{P-E} .

Repair and Calibration

To ensure that your instrument meets factory specifications, we recommend that it be sent back to our factory Service Center at one-year intervals for recalibration, or as required by other standards or internal procedures.

For instrument repair and calibration:

You must contact our Service Center for a Customer Service Authorization Number (CSA#). This will ensure that when your instrument arrives, it will be tracked and processed promptly. Please write the CSA# on the outside of the shipping container. If the instrument is returned for calibration, we need to know if you want a standard calibration, or a calibration traceable to N.I.S.T. (includes calibration certificate plus recorded calibration data).

Ship To:

(Or contact your authorized distributor.)

Contact us for the costs for repair, standard calibration, and calibration traceable to N.I.S.T.

NOTE: You must obtain a CSA# before returning any instrument.

Technical and Sales Assistance

If you are experiencing any technical problems, or require any assistance with the proper operation or application of your instrument, please call, mail, fax, or e-mail our technical support team:

□ _____

Limited Warranty

The instrument is warrantied to the owner for a period of two years from the date of original purchase against defects in manufacture, unless the instrument was registered within 30 days of the purchase date (see warranty note below). This limited warranty is given by AEMC® Instruments, not by the distributor from whom it was purchased. This warranty is void if the unit has been tampered with, abused, or if the defect is related to service not performed by AEMC® Instruments.

IMPORTANT WARRANTY NOTE:

By registering online within 30 days of the purchase date, your warranty will be extended to 3 years.

Please print the online Warranty Coverage Information for your records.

What AEMC® Instruments will do:

If a malfunction occurs within the warranty period, you may return the instrument to us for repair, provided we have your warranty registration information on file or a proof of purchase. AEMC® Instruments will repair or replace the faulty material at their discretion.

Warranty Repairs

What you must do to return an Instrument for Warranty Repair:

First, request a Customer Service Authorization Number (CSA#) by phone or by fax from our Service Department (see address below), then return the instrument along with the signed CSA Form. Please write the CSA# on the outside of the shipping container. Return the instrument, postage or shipment pre-paid to:

Caution: To protect yourself against in-transit loss, we recommend you insure your returned material.

NOTE: You must obtain a CSA# before returning any instrument.