

Power & Energy Logger Models PEL 102 & PEL 103



POWER & ENERGY LOGGERS (PEL)

Measure Up
WITH AEMC[®] INSTRUMENTS



Statement of Compliance

Chauvin Arnoux®, Inc. d.b.a. AEMC® Instruments certifies that this instrument has been calibrated using standards and instruments traceable to international standards.

We guarantee that at the time of shipping your instrument has met its published specification.

An NIST traceable certificate may be requested at the time of purchase, or obtained by returning the instrument to our repair and calibration facility, for a nominal charge.

The recommended calibration interval for this instrument is 12 months and begins on the date of receipt by the customer. For recalibration, please use our calibration services. Refer to our repair and calibration section at www.aemc.com.

Serial #: _____

Catalog #: 2137.51 / 2137.52 / 2137.61 / 2137.62

Model #: PEL 102 / PEL 103

Please fill in the appropriate date as indicated:

Date Received: _____

Date Calibration Due: _____



Chauvin Arnoux®, Inc.
d.b.a AEMC® Instruments
www.aemc.com

Copyright© Chauvin Arnoux®, Inc. d.b.a. AEMC® Instruments. All rights reserved.







No part of this documentation may be reproduced in any form or by any means (including electronic storage and retrieval or translation into any other language) without prior agreement and written consent from Chauvin Arnoux®, Inc., as governed by United States and International copyright laws.

Chauvin Arnoux®, Inc. d.b.a. AEMC® Instruments
15 Faraday Drive • Dover, NH 03820 USA
Tel: (800) 945-2362 or (603) 749-6434 • Fax: (603) 742-2346

This documentation is provided “as is,” without warranty of any kind, express, implied, or otherwise. Chauvin Arnoux®, Inc. has made every reasonable effort to ensure that this documentation is accurate; but does not warrant the accuracy or completeness of the text, graphics, or other information contained in this documentation. Chauvin Arnoux®, Inc. shall not be liable for any damages, special, indirect, incidental, or inconsequential; including (but not limited to) physical, emotional or monetary damages due to lost revenues or lost profits that may result from the use of this documentation, whether or not the user of the documentation has been advised of the possibility of such damages.

TABLE OF CONTENTS

1. INTRODUCTION	8
1.1 PRECAUTIONS FOR USE	9
1.2 RECEIVING YOUR SHIPMENT	9
1.3 ORDERING INFORMATION	9
1.3.1 Accessories	10
1.3.2 Replacement Parts	11
2. PRODUCT FEATURES	12
2.1 DESCRIPTION	12
2.2 FRONT PANEL FEATURES	13
2.3 BACK PANEL FEATURES	14
2.4 LEAD INPUTS	15
2.5 INSTALLATION OF THE COLOR-CODED ID MARKERS	15
2.6 CONNECTION FEATURES	16
2.7 MOUNTING AND LOCATION	16
2.8 BUTTON FUNCTIONS	16
2.9 LCD DISPLAY (PEL 103)	17
2.10 LED STATUS	18
2.11 MEMORY CAPACITY	19
3. OPERATION	20
3.1 CHARGING THE BATTERY	20
3.2 OPERATING THE PEL	20
3.3 TURNING THE INSTRUMENT ON/OFF 	21
3.3.1 Turning the PEL ON	21
3.3.2 Turning the PEL OFF	21
3.4 STARTING/STOPPING A RECORDING AND ENABLING BLUETOOTH	22
3.5 CONNECTIONS	22
3.5.1 Power Supply	22
3.5.2 Standby Mode (and Display Brightness)	23
3.5.3 Memory Card (SD-Card)	23
3.5.4 USB Connection to the PEL	23
3.5.5 LAN Ethernet Connection to the PEL	23
3.5.6 Bluetooth Connection to the PEL	24
3.5.6.1 Pairing using Windows 7	24

3.6	DISTRIBUTION SYSTEMS AND PEL HOOK-UPS	25
3.6.1	Single Phase 2-Wire	25
3.6.2	Single Phase 3-Wire (Split Phase from a center tap transformer).....	26
3.6.3	3-Phase 3-Wire Power Networks	26
3.6.3.1	3-Phase 3-Wire Δ (with 2 current sensors)	26
3.6.3.2	3-Phase 3-Wire Δ (with 3 current sensors)	27
3.6.3.3	3-Phase 3-Wire Open Δ (with 2 current sensors)	27
3.6.3.4	3-Phase 3-Wire Open Δ (with 3 current sensors].....	28
3.6.3.5	3-Phase 3-Wire Y (with 2 current sensors)	28
3.6.3.6	3-Phase 3-Wire Y (with 3 current sensors]	29
3.6.3.7	3-Phase 3-Wire Δ Balanced (with 1 current sensor).....	29
3.6.4	3-Phase 4-Wire Y Power Networks	30
3.6.4.1	3-Phase 4-Wire Y (with 3 current sensors)	30
3.6.4.2	3-Phase 4-Wire Y Balanced.....	30
3.6.4.3	3-Phase 4-Wire Y 2½ Element.....	31
3.6.5	3-Phase 4-Wire Δ	31
3.6.5.1	3-Phase 4-Wire Δ	31
3.6.5.2	3-Phase 4-Wire Open Δ	32
3.6.6	DC Power Networks	32
3.6.6.1	DC 2-Wire	32
3.6.6.2	DC 3-Wire	33
3.6.6.3	DC 4-Wire	33
3.7	LCD DISPLAY MODES (PEL 103 ONLY).....	34
3.7.1	Base Measurements - Displayed Values 	34
3.7.2	Energy - Displayed Values 	36
3.7.3	Harmonic Display Values 	40
3.7.4	Max Display Values 	41
3.7.5	Information Display Values 	42
3.7.6	Configuration  (PEL 103).....	43
4.	PEL CONTROL PANEL - DATAVIEW® SOFTWARE	45
4.1	INSTALLING DATAVIEW	45
4.2	PEL CONTROL PANEL.....	47
4.3	POWER & ENERGY LOGGER (PEL) ANDROID APP	48
5.	SPECIFICATIONS	49
5.1	REFERENCE CONDITIONS	49
5.2	ELECTRICAL SPECIFICATIONS	49
5.2.1	Voltage Inputs	49
5.2.2	Current Inputs	49
5.2.3	Accuracy Specifications (excluding current sensors)	50
5.2.3.1	Specifications at 50/60 Hz	50

5.2.3.2	Specifications @ 400 Hz.....	52
5.2.3.3	Specifications @ DC.....	52
5.2.3.4	Temperature.....	52
5.2.3.5	Common Mode Rejection	53
5.2.3.6	Magnetic Field Influence	53
5.2.4	Current Sensors.....	53
5.2.4.1	Precautions for Use	53
5.2.4.2	Use and Characteristics.....	53
5.2.4.3	MiniFlex® MA193 & MA194.....	53
5.2.4.4	Other Current Sensors.....	54
5.2.4.5	Accuracy	56
5.3	BLUETOOTH	58
5.4	POWER SUPPLY	58
5.5	MECHANICAL SPECIFICATIONS.....	58
5.6	ENVIRONMENTAL SPECIFICATIONS.....	58
5.7	SAFETY SPECIFICATIONS	59
5.8	ELECTROMAGNETIC COMPATIBILITY	59
6.	MAINTENANCE	60
6.1	BATTERY	60
6.2	BATTERY INDICATOR.....	60
6.3	CLEANING.....	60
6.4	UPDATING THE FIRMWARE	60
6.5	REPAIR AND CALIBRATION.....	62
6.6	TECHNICAL AND SALES ASSISTANCE	62
6.7	LIMITED WARRANTY	62
6.8	WARRANTY REPAIRS.....	63
7.	APPENDIX A.....	64
7.1	MEASUREMENTS	64
7.1.1	Definition.....	64
7.2	SAMPLING.....	65
7.2.1	Sampling Period	65
7.2.2	Locking of Sampling Frequency	65
7.2.3	AC/DC.....	65















7.2.4 Measurement of Neutral Current	65
7.2.5 "1 second" Quantities.....	65
7.2.6 Aggregation	66
7.2.7 Max	66
7.2.8 Energy Calculations.....	66
7.3 MEASUREMENT FORMULAS	66
7.4 AGGREGATION	68
7.5 SUPPORTED ELECTRICAL NETWORKS.....	70
7.6 PHASE ORDER.....	72
7.7 CURRENT PHASE ORDER	72
7.8 VOLTAGE PHASE ORDER.....	73
7.9 CURRENT VS VOLTAGE PHASE ORDER.....	74
7.10QUANTITIES ACCORDING TO THE SUPPLY SYSTEMS	75
7.11GLOSSARY OF TERMS	78

1. INTRODUCTION

Thank you for purchasing a **Power Energy Logger Model PEL 102 or PEL 103**.

For best results from your instrument and for your safety, read the enclosed operating instructions carefully and comply with the precautions for use. Only qualified and trained operators should use this product.

Symbols

	CAUTION - Risk of Danger! Indicates a WARNING . Whenever this symbol is present, the operator must refer to the user manual before operation
	Indicates a risk of electric shock. The voltage at the parts marked with this symbol may be dangerous
	Signifies that the instrument is protected by double or reinforced insulation
	USB socket
	SD Card.
	Ethernet socket (RJ45)
	Main power supply input.
	Ground/Earth.
	Important information to acknowledge
	Magnetic fields can damage hard drives and medical devices
	Important instructions to read and understand completely
	Refers to a type B current sensor. Application or withdrawal not authorized on conductors carrying dangerous voltages. Type B current sensor as per IEC 61010-2-032
	The product has been declared recyclable after analysis of its life cycle in accordance with the ISO14040 standard.
	This product complies with the Low Voltage & Electromagnetic Compatibility European directives (73/23/CEE & 89/336/CEE)
	In the European Union, this product is subject to a separate collection system for recycling electrical and electronic components in accordance with directive WEEE 2002/96/EC

Definition of Measurement Categories (CAT)

CAT IV corresponds to measurements performed at the primary electrical supply (<1000 V).

Example: primary overcurrent protection devices, ripple control units, and meters.

CAT III corresponds to measurements performed in the building installation at the distribution level.

Example: hardwired equipment in fixed installation and circuit breakers.

CAT II corresponds to measurements performed on circuits directly connected to the electrical distribution system.

Example: measurements on household appliances and portable tools.

1.1 Precautions For Use

This instrument complies with safety standard IEC 61010-2-030, the leads comply with IEC 61010-031 for voltages of 1000V in measurement category III or 600V in measurement category IV and the current sensors comply with IEC 61010-2-032. Failure to observe the safety instructions may result in electric shock, fire, explosion, and destruction of the instrument and of the installations.

- The operator and/or the responsible authority must carefully read and clearly understand the various precautions to be taken in use. Sound knowledge and a keen awareness of electrical hazards are essential when using this instrument.
- For your safety, use only the compatible leads and accessories delivered with the instrument, which comply with IEC standard 61010-031 (2002). When sensors or accessories having a lower voltage rating and/or category are connected to the instrument, the lower voltage and/or category applies to the system so constituted.
- Before each use, check that the leads, enclosures, and accessories are in perfect condition. Any lead, sensor or accessory on which the insulation is damaged (even partially) must be repaired or scrapped.

Do not use the instrument on networks for which the voltage or category exceeds those mentioned.

- Do not use the instrument if it seems to be damaged, incomplete, or poorly closed.
- Use only the AC power adapter and battery pack supplied by the manufacturer, which include specific safety features.
- When removing and replacing the battery and/or the SD-Card, make sure that the device is disconnected and switched off.
- We recommend using Personal Protection Equipment where required.
- Keep your hands away from unused terminals.
- If the instrument is wet, dry it before connecting it.
- All troubleshooting and metrological checks must be performed by authorized (competent and accredited) personnel, with the instrument completely disconnected.

1.2 Receiving Your Shipment

Upon receiving your shipment, make sure that the contents are consistent with the packing list. Notify your distributor of any missing items. If the equipment appears to be damaged, file a claim immediately with the carrier and notify your distributor at once, giving a detailed description of any damage. Save the damaged packing container to substantiate your claim.

1.3 Ordering Information

Power & Energy Logger Model PEL 102 (no LCD, w/3 MA193-10-BK sensors)	Cat. #2137.51
Power & Energy Logger Model PEL 103 (with LCD, w/3 MA193-10-BK sensors)	Cat. #2137.52
Power & Energy Logger Model PEL 102 (no LCD, no sensors).....	Cat. #2137.61
Power & Energy Logger Model PEL 103 (with LCD, no sensors)	Cat. #2137.62

Shipping Contents:



OR

(1) of the following:

Power Energy Logger Model PEL 102
 Power Energy Logger Model PEL 103
 Cat. #2137.51 or Cat. #2137.52



(4) Black Test Leads
 and Alligator Clips



(3) MiniFlex® MA193-10-BK
 Cat. #2140.48

(included only with the purchase of)
 Cat. 2137.51 or Cat. #2137.52



(1) Power Cord, 5 ft 115 V
 Cat. #5000.14



(12) Color-coded ID Markers
 Cat. #2140.45



(1) Small Classic Tool Bag
 Cat. #2133.72



(1) 5 ft USB Cable
 Cat. #2140.46



(1) USB SD-Card Adapter
 Cat. #5000.45

Also Included:

- (1) Safety Sheet for the PEL
- (1) Safety Sheet for the MiniFlex® Sensors
- (1) Compliance Sheet
- (1) 8 GB SD-Card
- (1) Quick Start User Guide
- (1) 4 GB USB Stick with User Manual & Dataview® Software
- (1) Battery (NiMH AAA 8.4 V) - Cat. #2137.81

1.3.1 Accessories

USB cable, A/B 10 ft (3m).....	Cat. #2136.80
600 V CAT III Power Adapter for use with PEL 102 & PEL 103	Cat. #2137.98
AC/DC Current Probe Model MR193-BK	Cat. #2140.28
AC Current Probe Model MN93-BK.....	Cat. #2140.32
AC Current Probe Model SR193-BK	Cat. #2140.33
AmpFlex® Sensor 24 in Model 193-24-BK (black connector)	Cat. #2140.34
AmpFlex® Sensor 36 in Model 193-36-BK (black connector)	Cat. #2140.35
AC Current Probe Model MN193-BK (black connector)	Cat. #2140.36
MiniFlex® Current Sensor 10 in Model MA193-10-BK (black connector)	Cat. #2140.48
MiniFlex® Current Sensor 14 in Model MA193-14-BK (black connector)	Cat. #2140.50
MiniFlex® Current Sensor 24 in Model MA194-24-BK (black connector)	Cat. #2140.80
AC/DC Current Probe Model SL261*	Cat. #1201.51
*BNC Adapter for Current Probe Model SL261	Cat. #2140.40

1.3.2 Replacement Parts

Small Classic Tool Bag	Cat. #2133.72
Battery (custom factory replacement NiMH AAA 8.4 V)	Cat. #2137.81
Set of 12 Color-coded Input ID Markers	Cat. #2140.45
USB Cable A/B, 5 ft (1.5 m).....	Cat. #2140.46
Power Cord, 5 ft (1.5 m) 115 V	Cat. #5000.14
USB SD-card Adapter.....	Cat. #5000.45
Lead, one, 10 ft (3 m) black lead with one black alligator clip	Cat. #2140.44

DataView® Software Updates are Available at www.aemc.com

**PEL Android App Available on the Google Play Store at
<https://play.google.com/store/apps/details?id=com.aemc.pel&hl=en>**

2. PRODUCT FEATURES

2.1 Description

PEL: Power and Energy Logger

The PEL 102 and PEL 103 are simple-to-use, single, dual (split-phase) and three phase (Y, Δ) power and energy loggers.

The PEL offers all the necessary functions for Power/Energy data logging for most of the 50 Hz, 60 Hz, and 400 Hz and DC distribution systems worldwide offering numerous distribution set-ups. The PEL is designed to work in 1000 V CAT III and 600 V CAT IV environments.

The PEL is compact in size and fits in many distribution panels.

The PEL provides the following measurements (or calculations):

- Direct voltage measurements up to 1000 V CAT III and 600 V CAT IV
- AC current measurements from 200 mA up to 10,000 A with MA193 external current sensors
- Power measurements: VA, W and var
- Energy measurements: VAh, Wh (source, load) and varh (4 quadrants)
- Power Factor (PF), Cos ϕ , and Tan Φ
- Crest Factor
- Total Harmonic Distortion (THD) for voltages and currents
- Harmonics from the fundamental signal up to the 50th order for 50/60 Hz voltages and currents
- Frequency measurements
- RMS and DC measurements @ 128 samples/cycle – each phase simultaneously
- Bright triple LCD on the Model PEL 103 (3 phases shown simultaneously)
- Storage of measured and calculated values on a SD-Card or SDHC-Card
- Automatic recognition of the different types of current sensors
- Configuration of current and voltage ratios with external sensors
- 17 types of supported hook-ups or electrical distribution systems
- USB, LAN, and Bluetooth communication
- DataView® Software for data download, viewing of measurements, real-time communication with a PC and report generation with predefined or custom templates

2.2 Front Panel Features

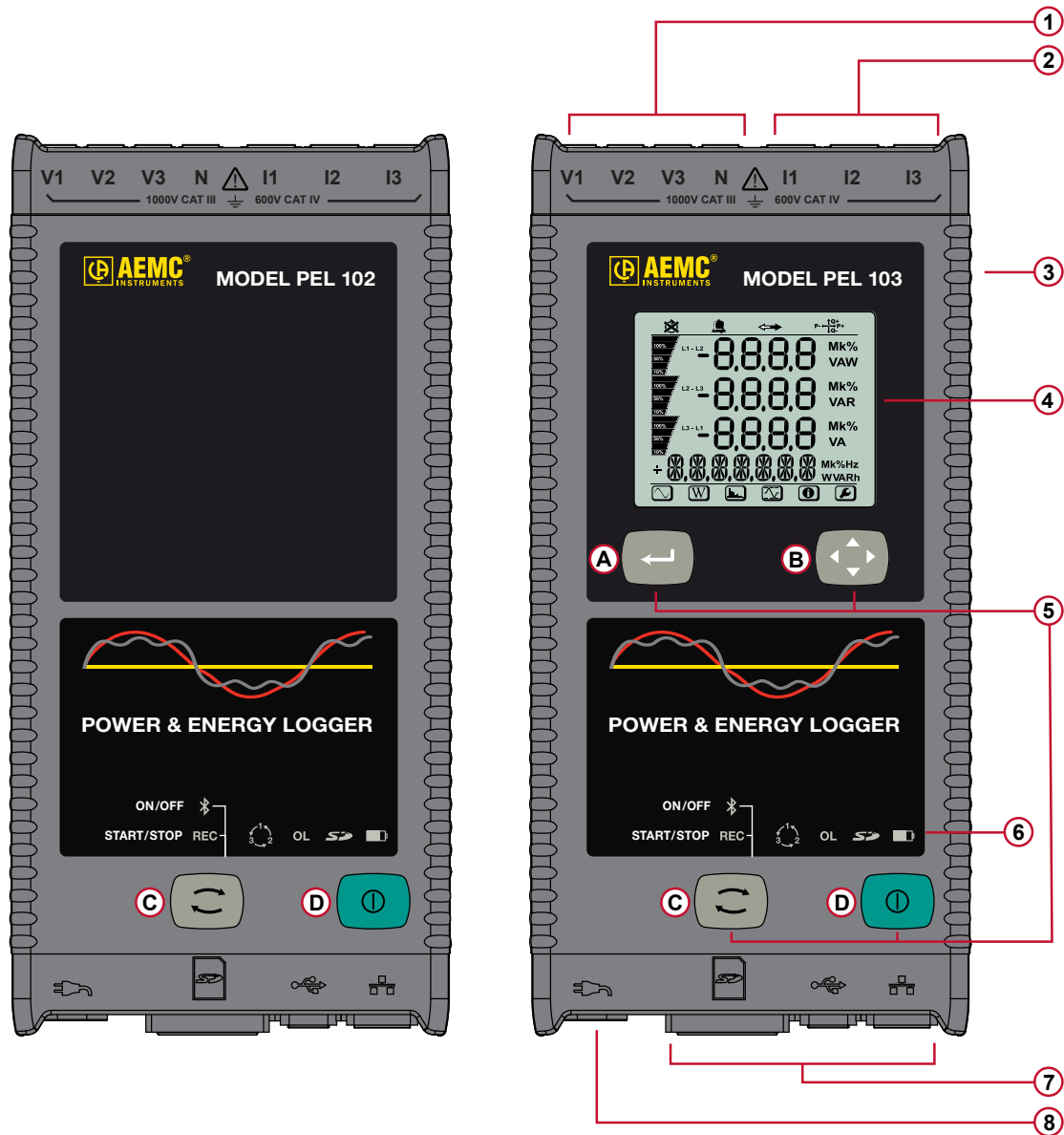

Figure 1

- ① Four voltage input terminals.
- ② Three current input terminals.
- ③ Rigid molded casing over-molded with thermo-adhesive rubber.
- ④ Digital LCD displaying measured, calculated and parameterizing quantities (see § 2.9).
- ⑤ Two (PEL 102) or Four (PEL 103) function buttons (see § 2.8).
 - Ⓐ Enter Button Ⓑ Navigation Button Ⓒ Control button Ⓓ On/Off button
- ⑥ Nine LEDs for status information (see § 2.10).
- ⑦ Connections for USB, Ethernet, SD memory card and terminal cover caps.
- ⑧ Standard (IEC C7 figure 8 terminal – non polarized) power connector for 110/250 VAC power source.

2.3 Back Panel Features

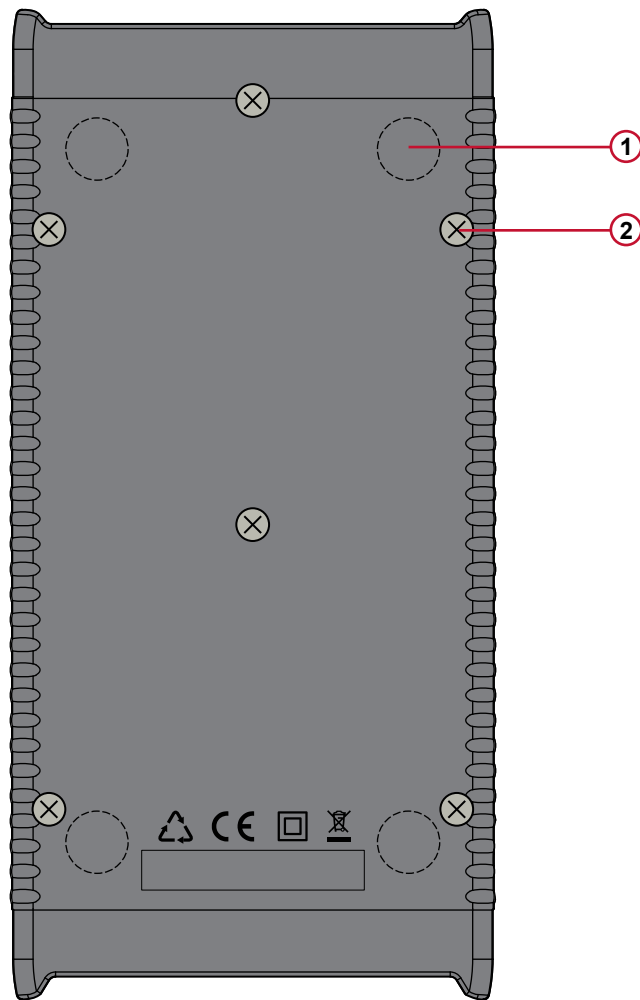

Figure 2

- ① Four magnets (molded into the rubber casing).
- ② Six recessed Torx® screws (for factory service use only).

2.4 Lead Inputs

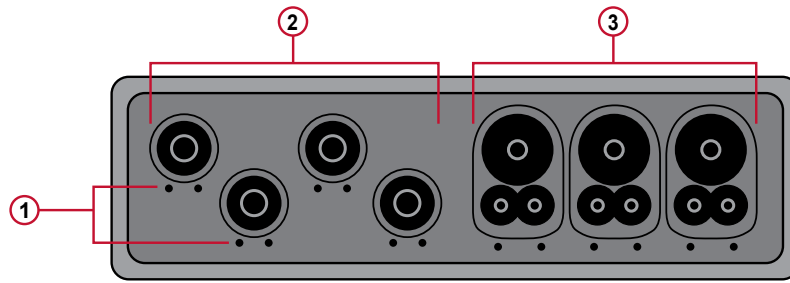

Figure 3

- ① (• •) are the color-coded ID marker insertion locations for the current or voltage inputs.
- ② Voltage input connectors (safety banana plug inputs).
- ③ Current sensor input connectors.

For multiple-phase measurements, start by marking the accessories using the color-coded ID markers supplied with the device; a different color for each current terminal.

Connect the measuring leads to your PEL as follows:

- Current measurement: I1, I2, I3 4-point connectors
- Voltage measurement: V1, V2, V3 and N terminals

The measuring leads must be connected to the circuit to be monitored according to the selected hook-up diagram. Do not forget to define the voltage and current transformer's ratios when necessary.

2.5 Installation of the Color-coded ID Markers

 Refer to the current sensor's safety sheet or user manual before connecting it.

Twelve sets of color-coded rings and inserts are supplied with your PEL instrument. Use these ID markers to identify the leads and input terminals.

- Detach the appropriate inserts from the color-coded marker and place them in the holes provided under the terminals (larger inserts for current terminals, smaller inserts for voltage terminals).
- Clip the rings of the same color to the ends of the lead you will be connecting to the terminal.

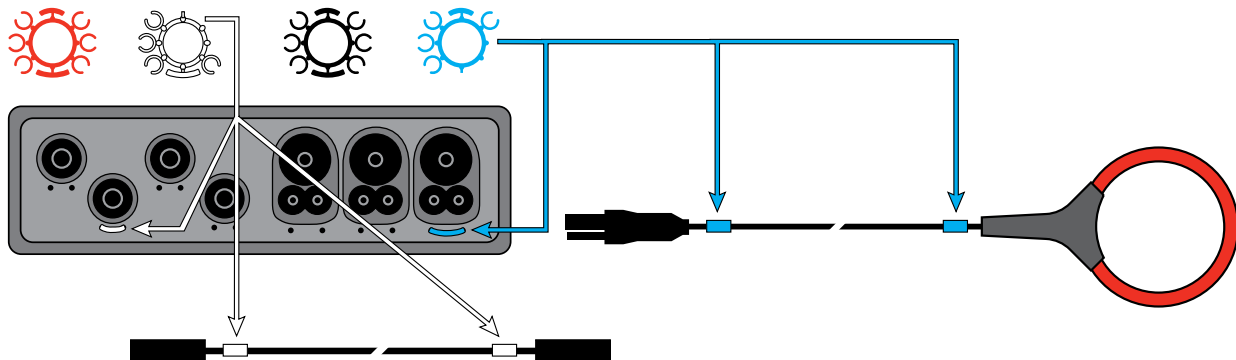

Figure 4

2.6 Connection Features

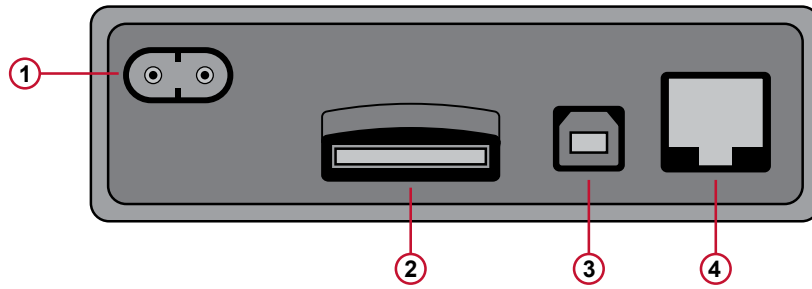

Figure 5

- ① Power cord connection (see § 3.5.1).
- ② SD card slot (see § 3.5.3).
- ③ USB connector (see § 3.5.4).
- ④ Ethernet RJ 45 connector (see § 3.5.5).

2.7 Mounting and Location



NOTE: Magnetic fields can damage hard drives and medical devices.

The PEL should be placed in a well-ventilated room; temperature not to exceed those specified in § 5.6.

The PEL 102 and PEL 103 can be mounted to a flat ferromagnetic vertical surface using the molded-in magnets.



Figure 6

2.8 Button Functions

BUTTON	DESCRIPTION
	ON/OFF Button: <ul style="list-style-type: none"> - Turns the instrument ON or OFF (see § 3.1). NOTE: The instrument cannot be turned OFF while connected to an AC outlet or if a recording is in progress.
	Control Button: <ul style="list-style-type: none"> - Starts/Stops the recording session and Enables/Disables Bluetooth (see § 3.4).
	Enter Button (PEL103): <ul style="list-style-type: none"> - Displays phase angle values and partial energies (long push) (see § 3.7.2)
	Navigation Button (PEL103): <ul style="list-style-type: none"> - Enables browsing and the selection of data displayed on the LCD (see § 3.7).

Table 1

2.9 LCD Display (PEL 103)

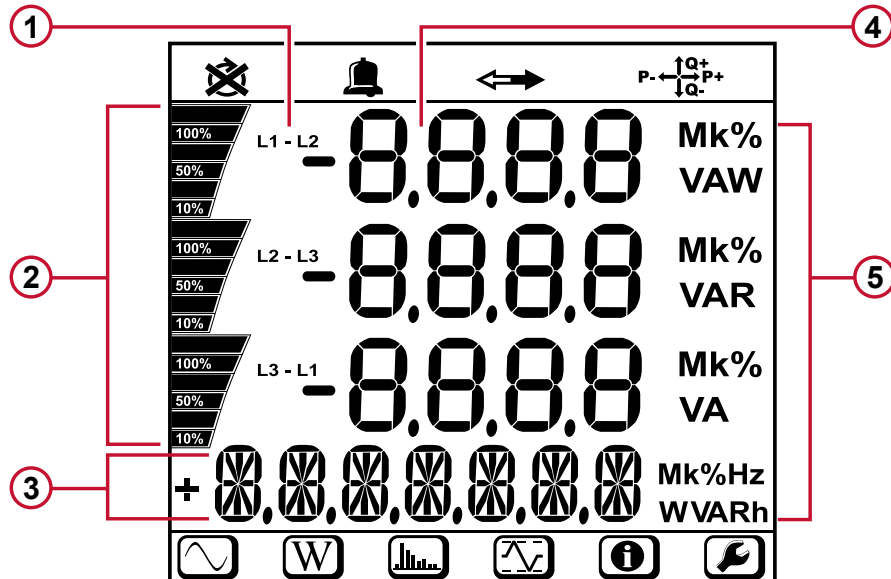

Figure 7

- ① Measured phase indicator.
- ② Bargraph (Load factor - Min - Max). The bargraph indicates the percentage (0 % to 100 %) of full range or full load as programmed into the PEL by the user through the DataView® software.
- ③ Measurements or page title.
- ④ Measurement values.
- ⑤ Measurement units.

Top and bottom display bars indicate the following:

ICON	DESCRIPTION
	Phase Sequence reversal indicator or missing phase (displayed only in Real-Time Measurement Mode)
	Data are available for recording (non-display indicates possible internal problem)
	Power quadrant indicator
	Real-time Measurement Mode
	Power and Energy Mode
	Harmonics Mode
	Max Mode
	Information Mode
	Configuration Mode

Table 2

2.10 LED Status

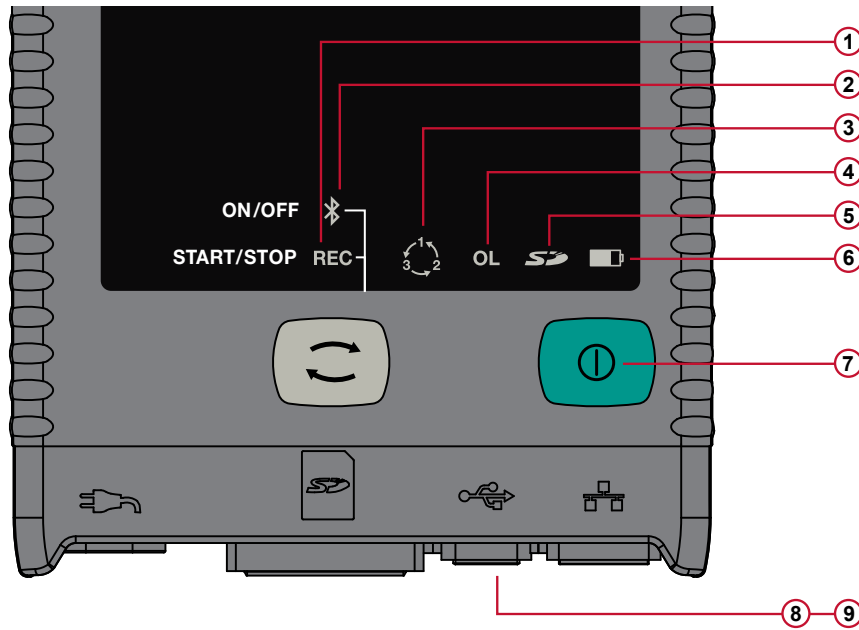

Figure 8

LED & COLOR	STATUS
①	Green LED: Recording Status <ul style="list-style-type: none"> - LED blinks once per second every 5 s: Logger in standby (not recording) - LED blinks twice per second every 5 s: Logger in recording mode
②	Blue LED: Bluetooth <ul style="list-style-type: none"> - LED OFF: Bluetooth OFF (disabled) - LED ON: Bluetooth ON (enabled - not transmitting) - LED blinks twice per second: Bluetooth ON (enabled - transmitting)
③	Red LED: Phase Order <ul style="list-style-type: none"> - OFF: Phase rotation order correct - LED blinks once per second: the order of phase rotation is incorrect. In this case, there are three possibilities: <ul style="list-style-type: none"> ■ Phase difference between the phase currents is 30° greater than normal (120° in three-phase and 180° in two-phase). ■ Phase difference between the phase voltages is 10° greater than normal. ■ Phase difference between the currents and voltages of each phase is 60° greater than 0° (load) or 180° (source).
④	Red LED: Overload <ul style="list-style-type: none"> - OFF: No input overload - LED blinks once per second: At least one input is in overload - LED ON: Indicates a current probe is either mismatched or missing
⑤	Red/Green LED: SD-Card Status <ul style="list-style-type: none"> - Green LED ON: SD-Card is OK - Red LED blinks five times every 5 s: SD-Card is full - Red LED blinks four times every 5 s: less than 1 week capacity remaining - Red LED blinks three times every 5 s: less than 2 weeks capacity remaining - Red LED blinks twice every 5 s: less than 3 weeks capacity remaining - Red LED blinks once every 5 s: less than 4 weeks capacity remaining - Red LED ON: SD-Card is not present or locked

LED & COLOR	STATUS
⑥	Yellow/Red LED: Battery Status <ul style="list-style-type: none"> - When the AC power cord is connected, the battery charges until it is full. - LED OFF: Battery full (with or without power supply) - Yellow LED ON: Battery is charging - Yellow LED blinks once per second: Battery is recovering from a full discharge - Red LED blinks twice per second: Low battery (and no power supply)
⑦ <i>under ON/OFF button</i>	Green LED: ON/OFF <ul style="list-style-type: none"> - LED ON: External power supply present - LED OFF: No external power supply
⑧ <i>embedded in the connector</i>	Green LED: Ethernet <ul style="list-style-type: none"> - LED OFF: No activity - LED blinking: Activity
⑨ <i>embedded in the connector</i>	Yellow LED: Ethernet <ul style="list-style-type: none"> - LED OFF: The stack failed to initialize or the Ethernet controller failed to initialize - Blink Slow, toggle every second: The stack initialized properly - Blink Fast, toggle 10 times per second: The Ethernet controller initialized properly - Blink Twice, toggle 2 times, then pause: DHCP Error - LED ON: Network initialized and ready for use

Table 3

2.11 Memory Capacity

The PEL accepts FAT32 formatted SD or SDHC cards 8 GB to 32 GB in size. This much data can require a lot of demand on a computer and a long download time (depending on the performance of the PC and connection type being used). Furthermore, some computers may have problems handling such a large amount of data and spreadsheets can only accept a limited amount of data.

Recording rates for the different types of session data are as follows:

- 1s Harmonics: 83 MB per day.
- 1s Trends: 17 MB per day.
- Aggregated data: 1.2 MB per day for 1 minute periods.
For longer periods, this rate is divided by the period in minutes.
Example: for an aggregation period of 10 minutes, the rate will be 0.12 MB per day.

We recommend managing the data on the SD card and only recording that which is needed. For reference purposes, a 5 day recording, with a 15 minute demand interval and recording 1 second data and harmonics on a 3-phase 4-wire network would consume approximately 530 MB of storage space. If harmonics are not needed and the recording of them is disabled, the space requirement is reduced to about 87 MB.

The recommended maximum recording times are:

- seven days when the recording includes the aggregated values, 1-second data, and harmonics.
- one month when the recording includes the aggregated values and 1-second data but not the harmonics.
- one year when the recording contains only the aggregated values.

Also avoid exceeding 32 recorded sessions on the SD card.

NOTE: For recordings with harmonics or with a duration longer than one week, please use class 4 or higher SDHC cards.

We recommend not downloading large sessions through Bluetooth as it will take a very long time. If a Bluetooth download is required, consider not recording 1 second trends and harmonics. The same 30 day recording would be reduced to just 2.5 MB.

Downloading over USB and Ethernet may be acceptable depending on the session size and network speed. We recommend putting the SD card into your PC directly or with the external card reader for fastest download time.

3. OPERATION

3.1 Charging the Battery

Before the first use, start by fully charging the battery.

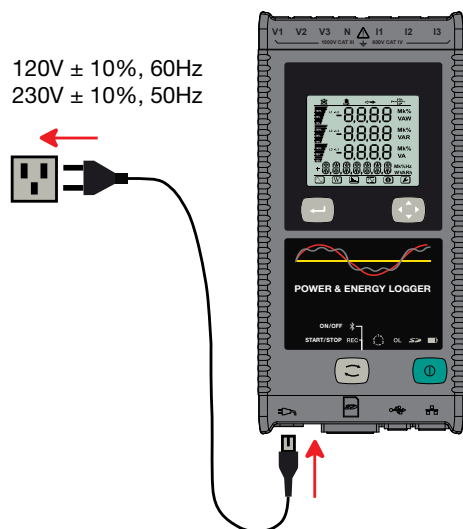





Figure 9

- Connect the supplied power cord to the instrument and AC power.
- The device will automatically turn ON.
- The  LED lights; it will go out only when the battery is fully charged.
- A low battery charging takes approximately 5 hours.

The Yellow/Red LED (see #6 Figure 8) is used to indicate the status of the battery.

- When the power is on, the battery is charging until it is full.
- LED OFF: Battery full (with or without power supply).
- Yellow LED ON/No blinks: Battery is charging.
- Yellow LED blinks twice per second: Battery is recovering after a full discharge.
- Red LED blinks twice per second: Low battery (and no power supply).

 After prolonged storage, the battery may be completely discharged. If so, the  LED blinks twice per second. In this case, at least 5 charge/discharge cycles will be necessary for your battery to recover 95 % of its capacity.

3.2 Operating the PEL

 **IMPORTANT:** The following OPERATION instructions assume that the PEL has been configured by the user prior to use. The PEL can only be fully configured through the PEL Control Panel distributed with the DataView® software, although on the PEL 103 some parameters (such as hookup type) can also be set through the LCD display on the device itself. Please refer to § 4.2 for setup instructions using DataView®, and § 3.7.6 for setup through the PEL 103 LCD display.

- The PEL must first be programmed before recording. This is done through the PEL Control Panel (see § 4.2) or, for the PEL 103, this can also be done on the LCD display (see § 3.7.6).
- The PEL is then connected to a power supply and will turn on automatically (see § 3.3.1).
- Recording is started by pressing the **Control** button  (see § 3.4).
- The PEL can be turned OFF when disconnected from the power supply (and when the recording session is completed - see § 3.3.2).

3.3 Turning the Instrument ON/OFF

3.3.1 Turning the PEL ON

To turn the PEL ON:

- Connect the PEL to a power outlet with the AC power cord and the PEL will turn ON automatically. If it does not, press the ON/OFF button for >2 seconds.
- The GREEN LED under the **ON/OFF** button turns ON when the PEL is connected to a live supply source.

 **NOTE:** The batteries automatically begin recharging when the PEL is connected to a live power outlet. Battery life is limited to approximately 1/2 hour when the battery is completely charged. This enables ride through during brief power outages and power shutdowns.

3.3.2 Turning the PEL OFF

The PEL will not turn OFF as long as it is connected to a power supply source and if a recording is ON.

NOTE: This is done as a precaution to ensure that the PEL is not accidentally turned OFF when recording and to ensure that the PEL turns on when the power supply is turned back on after an outage.

To turn the PEL OFF:

- Unplug the AC power supply outlet.
- Press the **ON/OFF** button for more than 2 seconds until all LEDs turn on. Then release the **ON/OFF** button.
- All LEDs and the display will turn off as the PEL powers down.
- If the PEL has supply power present it will not turn OFF.
- If a recording is pending or in progress it will not turn OFF.

 **NOTE:** Pressing the **ON/OFF** button when the instrument is powered and/or recording (or pending) does not stop the instrument. This is done to avoid any accidental or unintentional recording stoppage by the user. You must first unplug the power cord from the supply outlet, stop any recording session, power down by pushing the **ON/OFF** button for more than 2 seconds until all LEDs light up and then release the **ON/OFF** button.

3.4 Starting/Stopping a Recording and Enabling Bluetooth

Recordings are stored only on the SD card.

To Start a Recording:

- Insert the SD-card into the PEL.
- Use the **Control** button  to start or stop a recording session and to enable or disable Bluetooth.
- Press the **Control** button for more than 2 seconds and hold it down.
- The green REC LED (see #1 Figure 8) will light up for 3 s, followed by the lighting of the blue Bluetooth LED (see #2 Figure 8) for 3 s - one after another. During the time these LEDs are lit, you will be able to control their respective function as described below.
- Releasing the **Control** button during (and only during) the 3 s lighting of a particular LED performs the associated function:
 - **REC LED (START/STOP)**
 - A release while LED is lit starts a recording (if recording is OFF)
 - A release while LED is lit stops a recording (if recording is ON)
 - **BLUETOOTH LED (ON/OFF)**
 - A release while LED is lit turns ON Bluetooth (if Bluetooth is OFF)
 - A release while LED is lit turns OFF Bluetooth (if Bluetooth is ON)

If you want to make changes to both the Recording and Bluetooth, you need to go through the process twice.

 **NOTE:** If the **Control** button is locked (disabled) by the PEL Control Panel (see § 4), you cannot use it to start or stop a recording, or enable/disable Bluetooth. Instead, upon pressing the **Control** button while it is locked you will see the Bluetooth and REC lights blink twice, with no changes taking effect on the instrument. To enable the **Control** button, you must open the PEL Control Panel on your PC and de-select the “Lock out the Control button...” option in the Configure Instrument dialog box, as explained in the PEL Control Panel online Help.

3.5 Connections

3.5.1 Power Supply

The PEL is powered by standard AC power through an external C7 cord (figure-eight type, non-polarized power plug). This power cord is available in many computer or electrical supply stores. It is also referred to as a Laptop or Netbook C7 power cable. For replacement, be sure to buy the non-polarized cord. Replacement power cords are also available from the factory.

The PEL can be supplied from nominal 110 V to 250 V (accepts $\pm 10\%$) 50/60 Hz to accommodate available supply voltages globally.

 **NOTE:** Never use power cords with inadequate ratings.

- When the instrument is powered by AC power, the instrument is always ON.
- Applying AC power to the PEL turns the instrument ON if it was OFF and starts recharging the batteries automatically.
- When AC power is not present (power supply OFF or disconnected from a power supply), the instrument will run on battery power for approximately 30 minutes or less when Auto Power Off is enabled (see below).
- The PEL has a built in Auto Power OFF, which can be set to 3 to 15 min or disabled.

- When the battery level is too low and a Low Bat condition occurs (the red LED  blinks twice per second), the instrument will eventually turn OFF. The PEL will start up again once it has been reconnected to a power supply.
- When the instrument is not powered by AC power, it can be turned ON with the **ON/OFF** button (see § 3.3.1).
- When the instrument is not powered by AC power and no recording is pending or in progress, it can be turned OFF with the **ON/OFF** button (see § 3.3.2).

3.5.2 Standby Mode (and Display Brightness)

When the instrument is ON and there is no activity for a definite time period, the LCD (PEL 103) automatically goes into Standby mode.

The measurements and recording stay active, but the LCD backlight brightness diminishes to a user preset level. The Standby LCD brightness level is user programmed through the PEL Control Panel.

To re-establish the LCD Brightness, press the Enter or Navigation buttons.

Note that the overall display brightness is also programmed through the PEL Control Panel.

3.5.3 Memory Card (SD-Card)

The PEL 102 and PEL 103 use an SD card for data storage. SD or SDHC-Cards (8 GB up to 32 GB) formatted FAT32 are supported. The PEL is delivered with a formatted SD card in the instrument. If you want to install a new SD card, you must format the card before use.

- Formatting the SD-Card is possible through the PEL DataView Control Panel when connected to the instrument and if no recording is pending or in progress.
- Hot extraction from the PEL is possible when no recording is in progress.
- PEL files use short names (8 characters), such as Ses00004.

3.5.4 USB Connection to the PEL

The PEL 102 and PEL 103 can be connected to a computer through a USB (type A/Type B connectors) to configure the PEL, prepare a recording session (real-time connection) and download recording sessions.

 **NOTE:** Connecting the USB between the PC and the PEL will not power the logger or recharge the batteries.

3.5.5 LAN Ethernet Connection to the PEL

A LAN connection can be used to view real-time data, instrument status, configure the PEL, setup and start a recording session and download recorded sessions.

The PEL has an IP address. When configuring the PEL with the PEL Control Panel, if the checkbox next to “Enable DHCP” is checked in the Communication tab of the Configure Instrument dialog box, the instrument sends a request to the network DHCP server to automatically obtain an IP address.

If for any reason the DHCP server is not available, after 60 seconds the PEL Control Panel will enter auto-IP mode, using the default IP address **169.254.0.100** (the same IP address used when “Enable DHCP” is not selected). This auto-IP mode is compatible with APIPA (Automatic Private IP Addressing). A cross-over cable may be needed in auto-IP mode.

The Internet Protocol used is UDP. Port **3041** is used by default, but it can be modified in the PEL Control Panel (see § 4.2) to allow multiple PC connections to multiple PEL instruments behind a router.

 **NOTE:** The LAN parameters cannot be modified while connected over a LAN link. A USB connection must be used to modify them.

3.5.6 Bluetooth Connection to the PEL

The PEL 102 and PEL 103 are designed for a Bluetooth wireless connection to a computer. The Bluetooth connection can be used to configure the PEL, to prepare a recording session and to download recorded sessions.

To communicate using the Bluetooth connection you will need a computer with Bluetooth capability. Some computers are supplied with this capability, while others will need to have an external Bluetooth adapter.

The pairing procedure varies depending on your operating system, Bluetooth equipment and driver software.

The default pairing code is **0000** if needed. The pairing code cannot be modified through the PEL Control Panel (DataView® software).

NOTE: The information in the following section is only necessary the first time an instrument is connected.

3.5.6.1 Pairing using Windows 7

The following example uses the Windows 7 operating system procedure. The pairing procedure for other versions of Windows may vary.

1. First, make sure Bluetooth is enabled on the instrument.
2. Connect the USB adapter to the PC.
3. A Bluetooth symbol, similar to this , will appear in the taskbar (bottom-right side of your computer screen) once the driver is installed.
4. Double-click on the icon and select **“Add a Device”**.
5. In the **“Add a Device”** window, select the PEL model you wish to connect to and select **“Next”**.

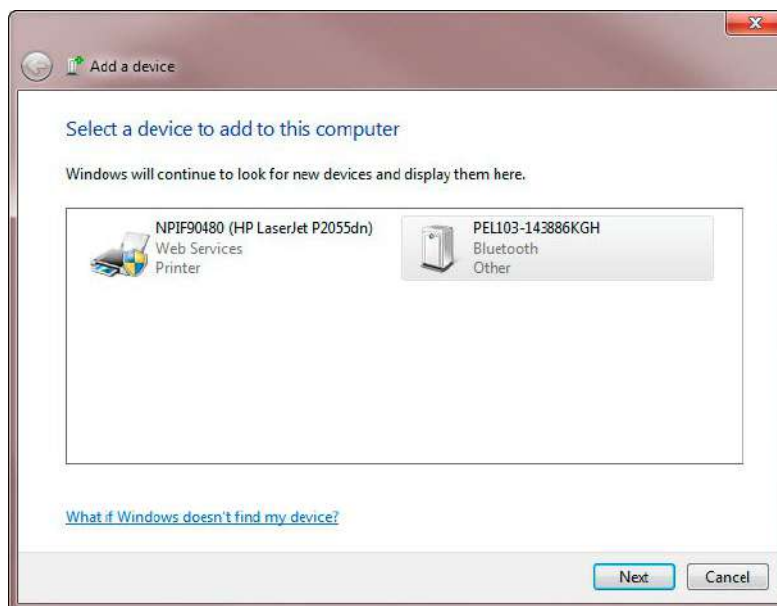

Figure 10

NOTE: Depending on the Bluetooth setup and operating system, it may be necessary to enter a passkey to finalize the instrument connection. If so, the default passkey is: **0000**.



6. Once the instrument has been successfully added to the computer, a window similar to Figure 11 will be displayed. Select “Close”.



Figure 11

7. Launch the PEL Control Panel using the icon placed on the desktop during the Dataview® software installation, then connect the instrument via Bluetooth by performing the steps in § 4.2.

3.6 Distribution Systems and PEL Hook-ups

This section describes how the current sensors and voltage test leads have to be connected to your installation according to its distribution system. The PEL shall also be configured for the selected distribution system. Source  →  Load

Single Phase 2-Wire

For Single Phase 2-Wire measurements:

- Connect the terminal N test lead to the neutral conductor
- Connect the terminal V1 test lead to the L1 phase conductor
- Connect the current probe to the L1 phase conductor

Ensure that the current arrow on the sensor is directed towards the load. This ensures proper phase angle for power measurements and other phase sensitive measurements.

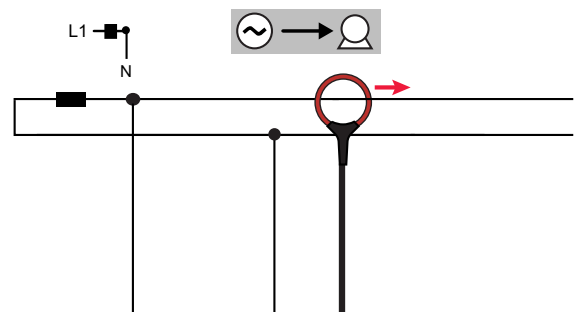

Figure 12

3.6.1 Single Phase 3-Wire (Split Phase from a center tap transformer)

For Single Phase 3-Wire (Split Phase) measurements:

- Connect the terminal N test lead to the neutral conductor
- Connect the terminal V1 test lead to the L1 phase conductor
- Connect the terminal V2 test lead to the L2 phase conductor
- Connect the terminal I1 current probe to the L1 phase conductor
- Connect the terminal I2 current probe to the L2 phase conductor

Ensure that the current arrow on the sensor is directed towards the load. This ensures proper phase angle for power measurements and other phase sensitive measurements.

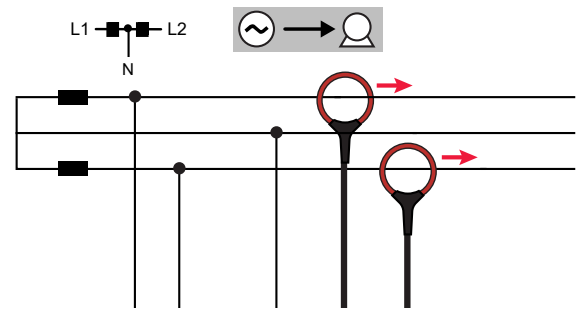

Figure 13

3.6.2 3-Phase 3-Wire Power Networks

3.6.2.1 3-Phase 3-Wire Δ (with 2 current sensors)

For 3-Phase 3-Wire Δ measurements using two current sensors:

- Connect the terminal V1 test lead to the L1 phase conductor
- Connect the terminal V2 test lead to the L2 phase conductor
- Connect the terminal V3 test lead to the L3 phase conductor
- Connect the terminal I1 current probe to the L1 phase conductor
- Connect the terminal I3 current probe to the L3 phase conductor

Ensure that the current arrow on the sensor is directed towards the load. This ensures proper phase angle for power measurements and other phase sensitive measurements.

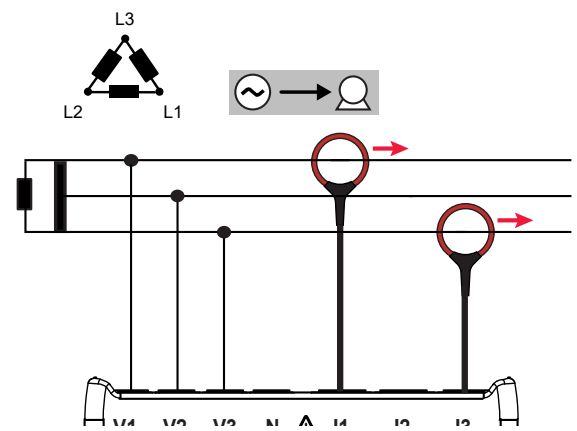

Figure 14

3.6.2.2 3-Phase 3-Wire Δ (with 3 current sensors)

For 3-Phase 3-Wire Δ measurements using three current sensors:

- Connect the terminal V1 test lead to the L1 phase conductor
- Connect the terminal V2 test lead to the L2 phase conductor
- Connect the terminal V3 test lead to the L3 phase conductor
- Connect the terminal I1 current probe to the L1 phase conductor.
- Connect the terminal I2 current probe to the L2 phase conductor
- Connect the terminal I3 current probe to the L3 phase conductor

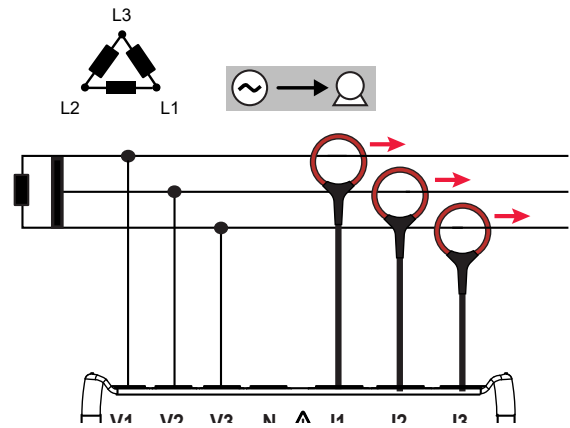

Figure 15

Ensure that the current arrow on the sensor is directed towards the load. This ensures proper phase angle for power measurements and other phase sensitive measurements.

3.6.2.3 3-Phase 3-Wire Open Δ (with 2 current sensors)

For 3-Phase 3-Wire Open Δ measurements using two current sensors:

- Connect the terminal V1 test lead to the L1 phase conductor
- Connect the terminal V2 test lead to the L2 phase conductor
- Connect the terminal V3 test lead to the L3 phase conductor
- Connect the terminal I1 current probe to the L1 phase conductor
- Connect the terminal I3 current probe to the L3 phase conductor

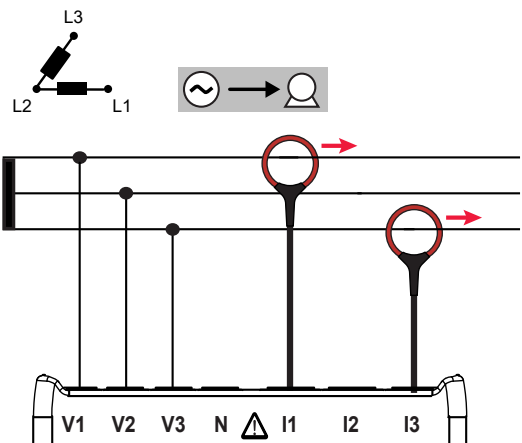

Figure 16

Ensure that the current arrow on the sensor is directed towards the load. This ensures proper phase angle for power measurements and other phase sensitive measurements.

3.6.2.4 3-Phase 3-Wire Open Δ (with 3 current sensors)

For 3-Phase 3-Wire Open Δ measurements using three current sensors:

- Connect the terminal V1 test lead to the L1 phase conductor
- Connect the terminal V2 test lead to the L2 phase conductor
- Connect the terminal V3 test lead to the L3 phase conductor
- Connect the terminal I1 current probe to the L1 phase conductor
- Connect the terminal I2 current probe to the L2 phase conductor
- Connect the terminal I3 current probe to the L3 phase conductor

Ensure that the current arrow on the sensor is directed towards the load. This ensures proper phase angle for power measurements and other phase sensitive measurements.

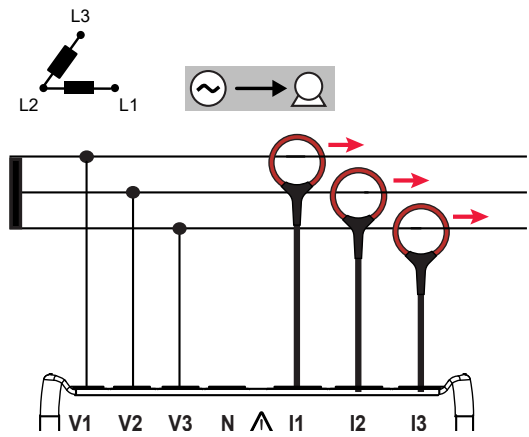

Figure 17

3.6.2.5 3-Phase 3-Wire Y (with 2 current sensors)

For 3-Phase 3-Wire Y measurements using two current sensors:

- Connect the terminal V1 test lead to the L1 phase conductor
- Connect the terminal V2 test lead to the L2 phase conductor
- Connect the terminal V3 test lead to the L3 phase conductor
- Connect the terminal I1 current probe to the L1 phase conductor
- Connect the terminal I3 current probe to the L3 phase conductor

Ensure that the current arrow on the sensor is directed towards the load. This ensures proper phase angle for power measurements and other phase sensitive measurements.

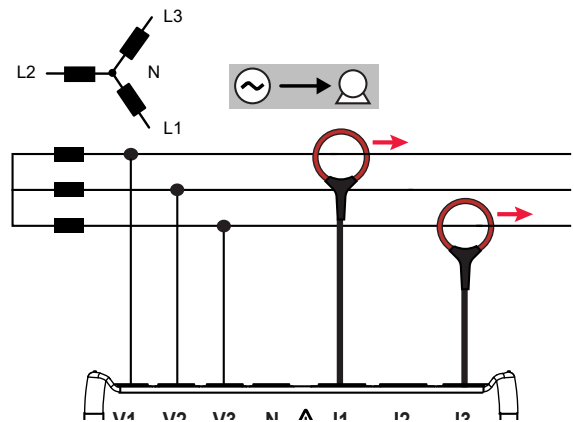

Figure 18

3.6.2.6 3-Phase 3-Wire Y (with 3 current sensors)

For 3-Phase 3-Wire Y measurements using three current sensors:

- Connect the terminal V1 test lead to the L1 phase conductor
- Connect the terminal V2 test lead to the L2 phase conductor
- Connect the terminal V3 test lead to the L3 phase conductor
- Connect the terminal I1 current probe to the L1 phase conductor
- Connect the terminal I2 current probe to the L2 phase conductor
- Connect the terminal I3 current probe to the L3 phase conductor

Ensure that the current arrow on the sensor is directed towards the load. This ensures proper phase angle for power measurements and other phase sensitive measurements.

3.6.2.7 3-Phase 3-Wire Δ Balanced (with 1 current sensor)

For 3-Phase 3-Wire Δ Balanced measurements using one current sensor:

- Connect the terminal V1 test lead to the L1 phase conductor
- Connect the terminal V2 test lead to the L2 phase conductor
- Connect the terminal I3 current probe to the L3 phase conductor

Ensure that the current arrow on the sensor is directed towards the load. This ensures proper phase angle for power measurements and other phase sensitive measurements.

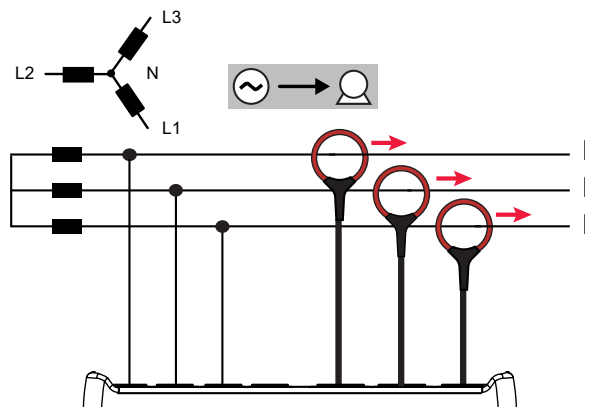

Figure 19

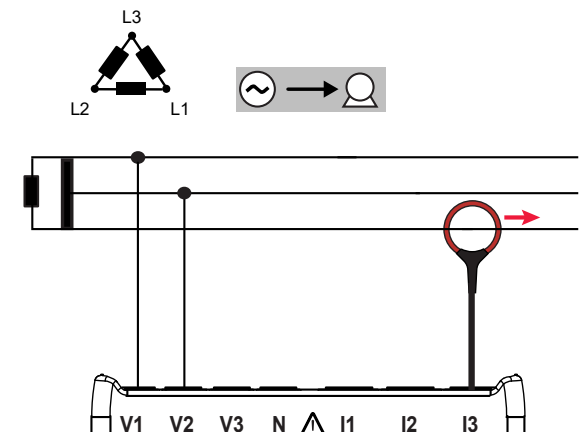

Figure 20

3.6.3 3-Phase 4-Wire Y Power Networks

3.6.3.1 3-Phase 4-Wire Y (with 3 current sensors)

For 3-Phase 4-Wire Y measurements using three current sensors:

- Connect the terminal N test lead to the neutral conductor
- Connect the terminal V1 test lead to the L1 phase conductor
- Connect the terminal V2 test lead to the L2 phase conductor
- Connect the terminal V3 test lead to the L3 phase conductor
- Connect the terminal I1 current probe to the L1 phase conductor
- Connect the terminal I2 current probe to the L2 phase conductor
- Connect the terminal I3 current probe to the L3 phase conductor

Ensure that the current arrow on the sensor is directed towards the load. This ensures proper phase angle for power measurements and other phase sensitive measurements.

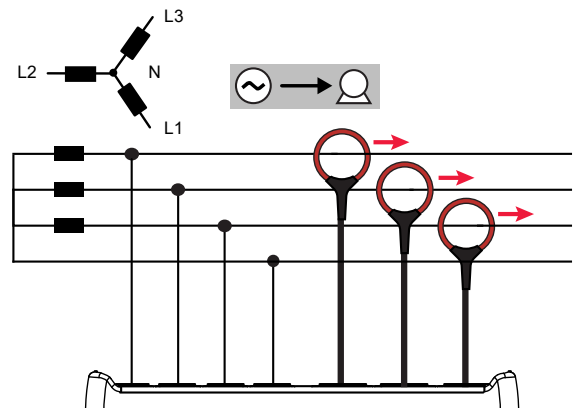

Figure 21

3.6.3.2 3-Phase 4-Wire Y Balanced

For 3-Phase 3-Wire Balanced Y measurements using one current sensor:

- Connect the terminal N test lead to the neutral conductor
- Connect the terminal V1 test lead to the L1 phase conductor
- Connect the terminal I1 current probe to the L1 phase conductor

Ensure that the current arrow on the sensor is directed towards the load. This ensures proper phase angle for power measurements and other phase.

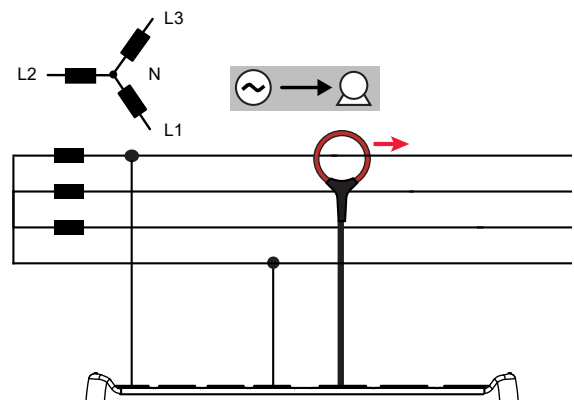

Figure 22

3.6.3.3 3-Phase 4-Wire Y 2½ Element

For 3-Phase 4-Wire Y 2½ Element measurements and using three current sensors:

- Connect the terminal N test lead to the neutral conductor
- Connect the terminal V1 test lead to the L1 phase conductor
- Connect the terminal V3 test lead to the the L3 phase conductor
- Connect the terminal I1 current probe to the L1 phase conductor
- Connect the terminal I2 current probe to the L2 phase conductor
- Connect the terminal I3 current probe to the L3 phase conductor

Ensure that the current arrow on the sensor is directed towards the load. This ensures proper phase angle for power measurements and other phase sensitive measurements.

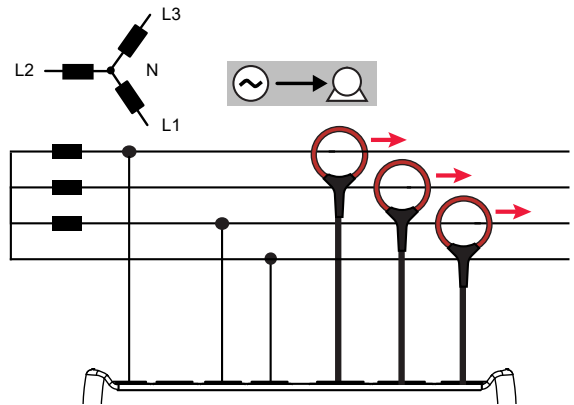

Figure 23

3.6.4 3-Phase 4-Wire Δ

High Leg configuration. No Potential Transformer (Voltage Transformer) is connected; the installation under test is supposed to be a low voltage distribution system.

3.6.4.1 3-Phase 4-Wire Δ

For 3-Phase 4-Wire Δ measurements and using three current sensors:

- Connect the terminal N test lead to the neutral conductor
- Connect the terminal V1 test lead to the L1 phase conductor
- Connect the terminal V2 test lead to the L2 phase conductor
- Connect the terminal V3 test lead to the L3 phase conductor
- Connect the terminal I1 current probe to the L1 phase conductor
- Connect the terminal I2 current probe to the L2 phase conductor
- Connect the terminal I3 current probe to the L3 phase conductor

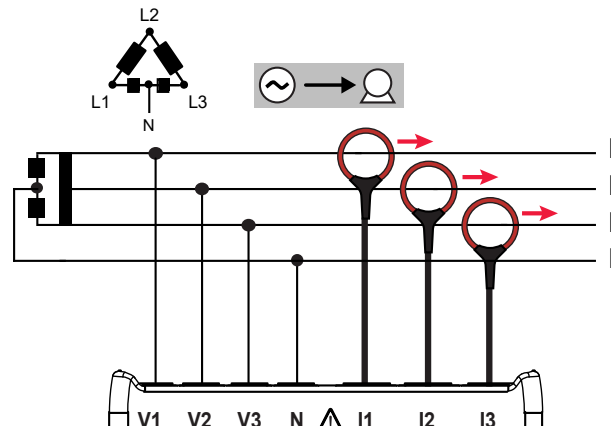

Figure 24

Ensure that the current arrow on the sensor is directed towards the load. This ensures proper phase angle for power measurements and other phase sensitive measurements.

3.6.4.2 3-Phase 4-Wire Open Δ

For 3-Phase 4-Wire Open Δ measurements and using three current sensors:

- Connect the terminal N test lead to the neutral conductor
- Connect the terminal V1 test lead to the L1 phase conductor
- Connect the terminal V2 test lead to the L2 phase conductor
- Connect the terminal V3 test lead to the L3 phase conductor
- Connect the terminal I1 current probe to the L1 phase conductor
- Connect the terminal I2 current probe to the L2 phase conductor
- Connect the terminal I3 current probe to the L3 phase conductor

Ensure that the current arrow on the sensor is directed towards the load. This ensures proper phase angle for power measurements and other phase sensitive measurements.

3.6.5 DC Power Networks

3.6.5.1 DC 2-Wire

For DC 2- Wire measurements:

- Connect the terminal N test lead to the common conductor
- Connect the terminal V1 test lead to conductor +1
- Connect the terminal I1 current probe to conductor +1

Ensure that the current arrow on the sensor is directed towards the load. This ensures proper measurements for power and other sign sensitive quantities.

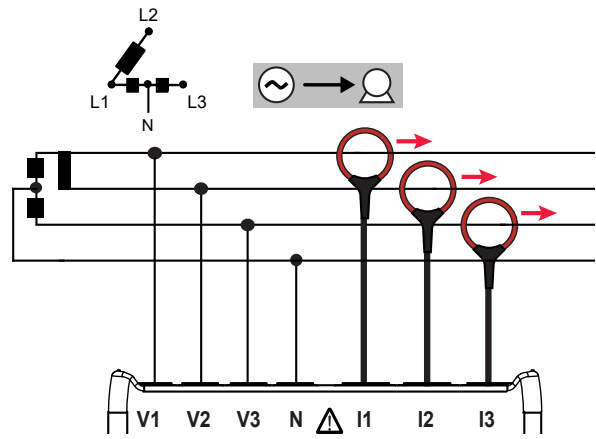

Figure 25

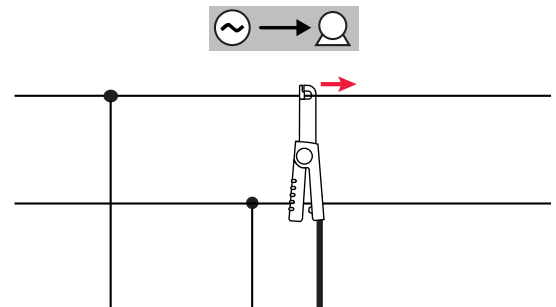

Figure 26

3.6.5.2 DC 3-Wire

For DC 3- Wire measurements:

- Connect the terminal N test lead to the common conductor
- Connect the terminal V1 test lead to conductor +1
- Connect the terminal V2 test lead to conductor +2
- Connect the terminal I1 current probe to conductor +1
- Connect the terminal I2 current probe to conductor +2

Ensure that the current arrow on the sensor is directed towards the load. This ensures proper measurements for power and other sign sensitive quantities.

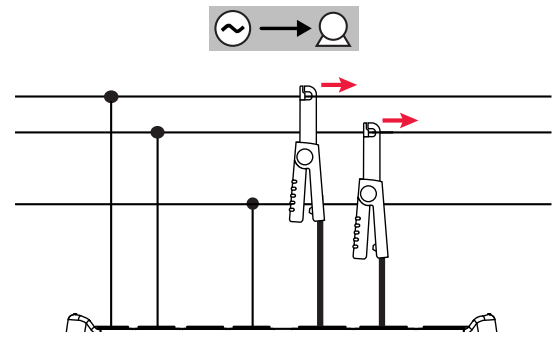

Figure 27

3.6.5.3 DC 4-Wire

For DC 4-Wire measurements and using three current sensors

- Connect the terminal N test lead to the common conductor
- Connect the terminal V1 test lead to conductor +1
- Connect the terminal V2 test lead to conductor +2
- Connect the terminal V3 test lead to conductor +3
- Connect the terminal I1 current probe to conductor +1
- Connect the terminal I2 current probe to conductor +2
- Connect the terminal I3 current probe to conductor +3

Ensure that the current arrow on the sensor is directed towards the load. This ensures proper measurements for power and other sign sensitive quantities.

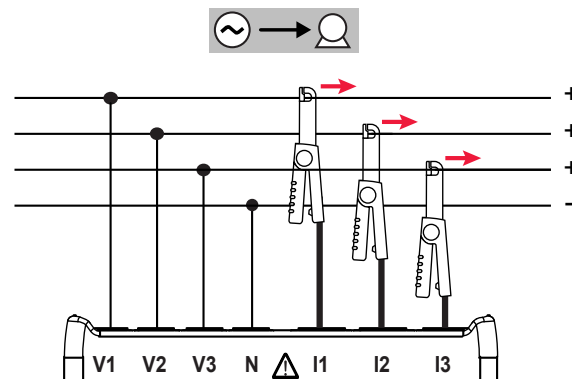



Figure 28

3.7 LCD Display Modes (PEL 103 Only)

The PEL 103 includes an LCD display that allows you to view a variety of measurement values and set-up parameters. The display also lets you change several configuration settings.

 **NOTE:** Although the PEL 103 LCD display allows you to enter a limited number of set-up values, the PEL can only be fully configured through the PEL Control Panel (DataView® software). Note that the PEL 102 can only be configured with the PEL Control Panel. For detailed instructions on configuring, recording and downloading measurements, refer to § 4.

The ◀ and ▶ navigation buttons are used to scroll through the available modes LCD Display modes.

Five of these modes allow you to view several types of data:

 **(Base Measurements)** displays the measurement values V, A, Power, Frequency, Power Factor, and Tangent Angle

 **(Energy)** displays the energy values kWk, Vah, and Varh

 **(Harmonics)** displays harmonics for current and voltage

 **(Max)** displays the maximum values for the measurement, energy, and harmonic values

 **(Information)** displays hook-up and system information

In addition:

 **(Configuration)** allows you to enter several setup parameters, described later in this section.

3.7.1 Base Measurements - Displayed Values

The base measurements, or instantaneous readings, are displayed sequentially in screens showing all phases. The display sequence varies per type of power network. Table 4 shows the readings per network.

To navigate through the displays, use the **Navigation**  and **Enter**  buttons.

- Use the up and down arrows (▲ or ▼) on the **Navigation** button to step through the displays.
- Use the **Enter** button to display additional information. Note that this does not advance the display to the next step. Instead, a screen displayed by Enter can be considered a “sub step” in the display cycle.
- To exit a display called up by Enter, press the **Navigation** button once. This returns you to the previous screen; you can then use ▲ or ▼ to continue navigating through the displays.
- To exit and move to a different display mode, press ◀ or ▶ on the **Navigation** button.

 **NOTE:** In some distribution systems and steps, pressing Enter has no effect.

Table 4 displays the LCD (PEL 103) sequence for each type of hook-up. The displays on the left show an example of a 3-Phase 4-Wire network type. The Step column shows which button to use to display the step, either ▼ to display a main step or ◀ to display a “sub step” (1a, 2a, and so on).

Step	1-Phase 2-Wire	DC 2-Wire	1-Phase 3-Wire	DC 3-Wire	3-Phase 3-Wire ^(*)	3-Phase 3-Wire Balanced	3-Phase 4-Wire (3P-4WY; 3P-4WY2)	3-phase 4-wire Δ (3P-4WΔ; 3P-4W0Δ)	3-Phase 4-Wire Balanced	DC 4-Wire
1 ◀▶	P I V F	P DC I DC V DC	I1 I2 F	I1 DC I2 DC	I1 I2 I3	I3 I3 I3	I1 I2 I3 «IN» IN	I1 I2 I3 «IN» IN	I1 I1 I1	I1 DC I2 DC I3 DC
1a ◀	ϕ (I1, V1) «V-I ANGLE»		ϕ (I2, I1) «I ANGLE»		ϕ (I2, I1) ϕ (I3, I2) ϕ (I1, I3) «I ANGLE»		ϕ (I2, I1) ϕ (I3, I2) ϕ (I1, I3) «I ANGLE»	ϕ (I2, I1) ϕ (I3, I2) ϕ (I1, I3) «I ANGLE»		
2 ▼	P Q S «PF» PF		V1 V2 U12	V1 DC V2 DC	U12 U23 U31 F	U12 U12 U12 F	V1 V2 V3	V1 - V3	V1 V1 V1	V1 DC V2 DC V3 DC
2a ◀			ϕ (V2, V1) «V ANGLE»		ϕ (U31, U 23) ϕ (U12, U31) ϕ (U23, U12) «U ANGLE»		ϕ (V2, V1) ϕ (V3, V2) ϕ (V1, V3) «V ANGLE»	- - ϕ (V1, V3) «V ANGLE»		
3 ▼	P Q S «TAN» TAN		P Q S «<<PF>> PF	P DC	P Q S «PF» PF	P Q S «PF» PF	U12 U23 U31 F	U12 U23 U31 F	U12 U23 U31 F	P DC
3a ◀			ϕ (I1, V1) ϕ (I2, V2) «V-I ANGLE»		ϕ (I1, U12) ϕ (I2, U23) ϕ (I3, U31) «U-I ANGLE»	ϕ (I3, U12) «U-I ANGLE»	ϕ (U31, U23) ϕ (U12, U31) ϕ (U23, U12) «U ANGLE»	ϕ (U31, U23) ϕ (U12, U31) ϕ (U23, U12) «U ANGLE»		

4 ▼			P Q S «<<TAN>> TAN		P Q S «TAN» TAN	P Q S «TAN» TAN	P Q S «PF» PF	P Q S «PF» PF	P Q S «PF» PF	
4a 							φ (I1, V1) φ (I2, V2) φ (I3, V3) «V-I ANGLE»	φ (I1, V1) - φ (I3, V3) «V-I ANGLE»	φ (I1, V1) «V-I ANGLE»	
5 ▼							P Q S «TAN» TAN	P Q S «TAN» TAN	P Q S «TAN» TAN	

Table 4

Note « ... » = displayed text

* 3-Phase 3-Wire includes:

- 3-Phase 3-Wire Δ (with 2 current sensors)
- 3-Phase 3-Wire Δ (with 3 current sensors)
- 3-Phase 3-Wire Open Δ (with 2 current sensors)
- 3-Phase 3-Wire Open Δ (with 3 current sensors]
- 3-Phase 3-Wire Y (with 2 current sensors)
- 3-Phase 3-Wire Y (with 3 current sensors]

3.7.2 Energy - Displayed Values

The PEL measures the typical energy readings used. In addition, it enables advanced measurements for specialists or individuals doing in-depth analysis.

Individual power magnitudes for Power Flow Quadrants (per IEC 62053-23) are available by simply scrolling through each screen display. The values in each quadrant are often used by engineers addressing power flow issues

Energy measurements, which are time dependent (typically 10 or 15 minute integration or aggregation periods), are displayed sequentially in screens showing all phases. Table 2 shows the readings per network type.

- The down arrow ▼ scrolls downward and the up arrow ▲ scrolls upward through the displays.
- Each display is reached by pressing the down arrow ▼.

Energies are measured from the beginning of the recording session. Partial energies are the energies measured for a defined period.

- Partial Energy is reached by pressing the  button for > 2 sec.
- To reenter the Energy setting, simply push the down arrow ▼.

Definitions:

- **P+**: Total Active Energy Imported (used by load) in kWh
- **P-**: Total Active Energy Exported (to source) in kWh
- **q1**: Active Energy Imported (by load) in Inductive Quadrant (Quadrant 1) in kvarh
- **q2**: Active Energy Exported (to source) in Capacitive Quadrant (Quadrant 2) in kvarh
- **q3**: Active Energy Exported (to source) in Inductive Quadrant (Quadrant 3) in kvarh
- **q4**: Active Energy Imported (by load) in Capacitive Quadrant (Quadrant 4) in kvarh
- **S+**: Total Apparent Energy Imported (by load) in kVAh
- **S-**: Total Apparent Energy Exported (to source) in kVAh

Typically, industrial users will focus on the following values. The other values are used for load analysis and utilities.

- **kWh**: Ep+ which is the traditional load Active Energy
- **kvarh**: Eq1 which is the traditional load Reactive Energy
- **kVAh**: Es+ which is the traditional load Apparent Energy

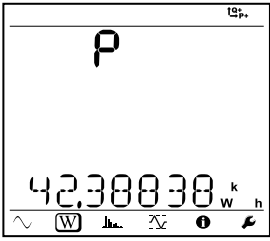
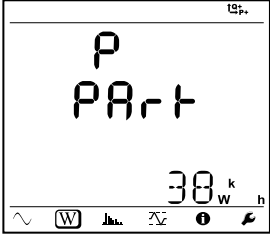
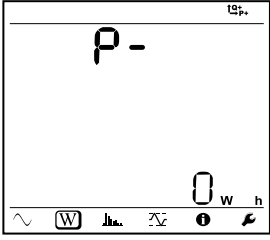
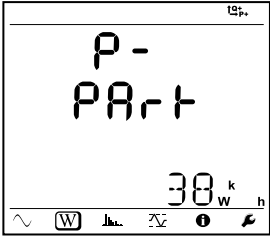
Step	Display AC	AC	DC
<p>1</p> <p>↔</p> <p>↩</p>	 	<p><<P>></p> <p>P</p>	<p><<P>></p> <p>P</p>
<p>2</p> <p>▼</p> <p>↩</p>	 	<p><<P->></p> <p>P-</p>	<p><<P->></p> <p>P-</p>

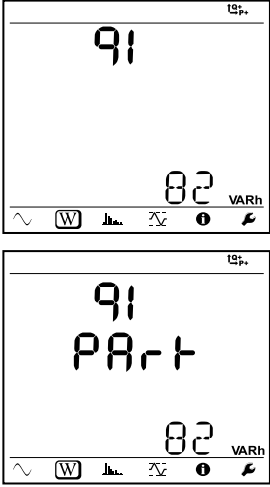
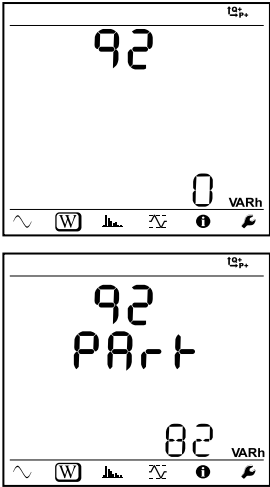
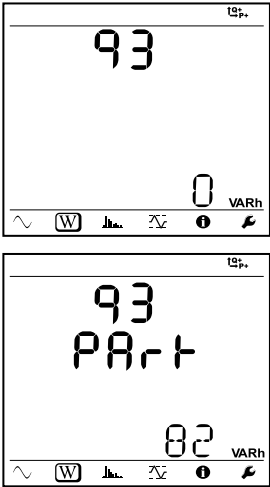
Step	Display AC	AC	DC
<p data-bbox="180 239 201 289">3 ▼</p> <p data-bbox="164 495 217 533">←</p>		<p data-bbox="808 197 894 226"><<q1>></p> <p data-bbox="834 281 867 310">q1</p>	
<p data-bbox="180 749 201 800">4 ▼</p> <p data-bbox="164 1010 217 1047">←</p>		<p data-bbox="808 707 894 737"><<q2>></p> <p data-bbox="834 791 867 821">q2</p>	
<p data-bbox="180 1276 201 1327">5 ▼</p> <p data-bbox="164 1516 217 1554">←</p>		<p data-bbox="808 1220 894 1249"><<q3>></p> <p data-bbox="834 1304 867 1333">q3</p>	

Step	Display AC	AC	DC
<p>6 ▼</p> <p>←</p>		<p><<q4>></p> <p>q4</p>	
<p>7 ▼</p> <p>←</p>		<p><<S>></p> <p>S</p>	
<p>8 ▼</p> <p>←</p>		<p><<S->></p> <p>S-</p>	

Table 5

3.7.3 Harmonic Display Values

Table 6 displays the LCD (PEL 103) sequence for each type of hook-up.

Step	1-Phase 2-Wire	1-Phase 3-Wire	3-Phase 3-Wire ⁽¹⁾	3-Phase 3-Wire Balanced	3-Phase 4-Wire ⁽²⁾	3-Phase 4-Wire Balanced
1	THD_I THD_V <<THD I-V>>	THD_I1 THD_I2 « THD I»	THD_I1 THD_I2 THD_I3 « THD I»	THD_I3 THD_I3 THD_I3 <<THD I>>	THD_I1 THD_I2 THD_I3 « THD IN» IN	THD_I1 THD_I1 THD_I1 <<THD I>>
2		THD_V1 THD_V2 THD_U12 «THD V-U»	THD_U12 THD_U23 THD_U31 <<THD U>>	THD_U12 THD_U12 THD_U12 <<THD U>>	THD_V1 THD_V2 THD_V3 «THD V»	THD_V1 THD_V1 THD_V1 <<THD V>>

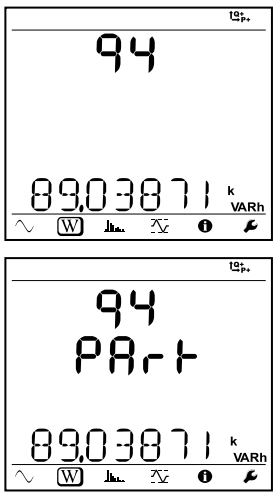
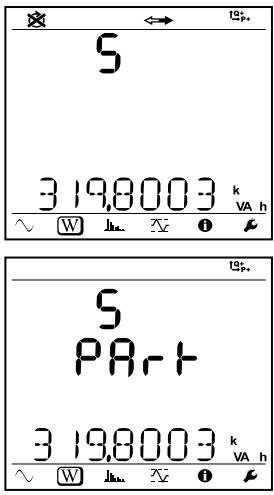
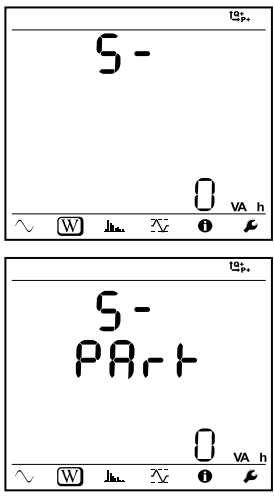
Table 6

Harmonics function is disabled in DC

(1) 3-Phase 3-Wire includes:

- 3-Phase 3-Wire Δ (with 2 current sensors)
- 3-Phase 3-Wire Δ (with 3 current sensors)
- 3-Phase 3-Wire Open Δ (with 2 current sensors)
- 3-Phase 3-Wire Open Δ (with 3 current sensors]
- 3-Phase 3-Wire Y (with 2 current sensors)
- 3-Phase 3-Wire Y (with 3 current sensors]

(2) 3-Phase 4-Wire includes:

- 3-Phase 4-Wire Y (with 3 current sensors)
- 3-Phase 4-Wire Y 2½ Element
- 3-Phase 4-Wire Δ
- 3-Phase 4-Wire Open- Δ

3.7.4 Max Display Values

Table 7 displays the LCD (PEL 103) sequence for each type of hook-up. Note that when a recording is in progress, Max is the maximum of the one second measurements during an aggregation period. This is reset either (1) when a new aggregation period starts, or (2) continuously, depending on how this setting is configured. You can also reset this value manually through the PEL Control Panel (see § 4.4.1). When no recording is in progress, Max represents the maximum of the one second measurements since the end of the last recording.

Step	1-Phase 2-Wire	DC 2-Wire	1-Phase 3-Wire	DC 3-Wire	3-Phase 3-Wire ⁽¹⁾	3-Phase 3-Wire Balanced	3-Phase 4-Wire ⁽²⁾	3-Phase 4-Wire Balanced	DC 4-Wire
1	I V	«DC Mode no max»	I1 I2	«DC Mode no max»	I1 I2 I3	I3 I3 I3	I1 I2 I3 «IN» IN	I1 I1 I1	«DC Mode no max»
2	P Q S «LOAD»		V1 V2 U12		U12 U23 U31	U12 U12 U12	V1 V2 V3	V1 V1 V1	
3	P Q S «SOURCE»		P Q S «LOAD»		P Q S «LOAD»	P Q S «LOAD»	U12 U23 U31	U12 U23 U31	
4			P Q S «SOURCE»		P Q S «SOURCE»	P Q S «SOURCE»	P Q S «LOAD»	P Q S «LOAD»	
5							P Q S «SOURCE»	P Q S «SOURCE»	

Table 7

(1) 3-Phase 3-Wire includes:

- 3-Phase 3-Wire Δ (with 2 current sensors)
- 3-Phase 3-Wire Δ (with 3 current sensors)
- 3-Phase 3-Wire Open Δ (with 2 current sensors)
- 3-Phase 3-Wire Open Δ (with 3 current sensors]
- 3-Phase 3-Wire Y (with 2 current sensors)
- 3-Phase 3-Wire Y (with 3 current sensors]

(2) 3-Phase 4-Wire includes:

- 3-Phase 4-Wire Y (with 3 current sensors)
- 3-Phase 4-Wire Y 2½ Element
- 3-Phase 4-Wire Δ
- 3-Phase 4-Wire Open-Δ

3.7.5 Information Display Values

This screen is disabled if three minutes elapse with no activity on the Enter or Navigation buttons. The display then returns to the Base Measurements screen.

Step	Value	Units
1	<<HOOK UP>> Distribution System Type	1P-2W = 1-phase 2-wire 1P-3W = 1-phase 3-wire 3P-3WΔ3 = 3-phase 3-wire Δ (3 current sensors) 3P-3WΔ2 = 3-phase 3-wire Δ (2 current sensors) 3P-3W02 = 3-phase 3-wire Open Δ (2 current sensors) 3P-3W03 = 3-phase 3-wire Open Δ (3 current sensors) 3P-3WΔB = 3-phase 3-wire Δ balanced 3P-3WY = 3-phase 3-wire Y (3 current sensors) 3P-3WY2 = 3-phase 3-wire Y (2 current sensors) 3P-4WY = 3-phase 4-wire Y 3P-4WYB = 3-phase 4-wire Y balanced (fixed, voltage measurement) 3P-4WY2 = 3-phase 4-wire Y 2½ 3P-4WΔ = 3-phase 4-wire Δ 3P-4W0Δ = 3-phase 4-wire Open Δ DC-2W = DC 2-wire DC-3W = DC 3-wire DC-4W = DC 4-wire
2	«PT PRIM» Primary VT	V / kV = Primary nominal voltage: 50V to 650kV
3	«PT SEC» Secondary VT	V = Secondary nominal voltage: 50V to 1000V
4	«CT PRIM» Primary CT	A / kA = Primary nominal line current for the connected sensor <ul style="list-style-type: none"> ■ For AmpFlex®: 100A, 400A, 2000A, 10,000A ■ For MN93A 5A range: 5A to 25,000A ■ For 5 A adapter box: 5A to 25,000A ■ For E3N clamp: 1A to 25,000A
5	«AGG.PERIOD» Aggregation period	Displays the aggregation period in minutes (1, 2, 3, 4, 5, 6, 10, 12, 15, 20, 30, 60)
6	Year Month Day Time	Displays the date/time
7	<<IP Addr>> IP address	Scrolling IP address
8	<<Soft>> Software Version Serial Number	1st number = DSP firmware version 2nd number = Microprocessor firmware version Scrolling serial number (a label is also pasted inside the PEL on the main board)

Table 8



3.7.6 Configuration (PEL 103)

The Configuration mode lets you select the distribution system (hook up), voltage ratio and primary current value, primary CT value, and aggregation period on the Model PEL 103 instrument. This screen is inactive when:

- The PEL is recording (pending or in progress).
- Configuration via the DataView PEL Control Panel is in progress.
- The button is locked through an option in the PEL Control Panel.
- Configuration is disabled by the **Control** button on the front panel.

 **NOTE:** To avoid conflicts, when the Configuration screen is displayed, configuration through the PEL Control Panel is disabled. You also cannot start a recording session with the **Control** button while the Configuration screen is displayed. If you attempt to use the **Control** button while it is locked by the PEL Control Panel, the Bluetooth ON/OFF indicator and the REC START/STOP light will flash twice simultaneously. The instrument will then continue its operation with no changes taking effect.

To change configuration settings on the Model PEL 103, enter the Configuration mode and do the following:

1. Scroll to the setting you want to change using the down arrow ▼ and up arrow ▲ buttons.
2. Press the **Enter**  button. The displayed setting will start blinking.
3. Use the **Navigation**  button to scroll through the allowable values for the setting.
4. When the desired value appears, press the **Enter** button. The setting will stop blinking.

As with the Information screen, the Configuration screen is disabled if three minutes elapse with no activity on the Enter or arrow buttons. The display then returns to the Base Measurements screen.

Step	Value	Units
1	<<HOOK UP>> Distribution System Type	1P-2W = 1-phase 2-wire 1P-3W = 1-phase 3-wire 3P-3WΔ3 = 3-phase 3-wire Δ (3 current sensors) 3P-3WΔ2 = 3-phase 3-wire Δ (2 current sensors) 3P-3W02 = 3-phase 3-wire Open Δ (2 current sensors) 3P-3W03 = 3-phase 3-wire Open Δ (3 current sensors) 3P-3WΔB = 3-phase 3-wire Δ balanced 3P-3WY = 3-phase 3-wire Y (3 current sensors) 3P-3WY2 = 3-phase 3-wire Y (2 current sensors) 3P-4WY = 3-phase 4-wire Y 3P-4WYB = 3-phase 4-wire Y balanced (fixed, voltage measurement) 3P-4WY2 = 3-phase 4-wire Y 2½ 3P-4WΔ = 3-phase 4-wire Δ 3P-4W0Δ = 3-phase 4-wire Open Δ DC-2W = DC 2-wire DC-3W = DC 3-wire DC-4W = DC 4-wire
2	«PT PRIM» Primary VT	V / kV = Primary nominal voltage: 50V to 650kV

3	«PT SEC» Secondary VT	V = Secondary nominal voltage: 50V to 1000V
4	«CT PRIM» Primary CT	<p>Primary nominal line current for the connected sensor. For AmpFlex: 100A, 400A, 2000A, 10,000A For MN193 5A range: 5A to 25,000A For 5A adapter box: 5A to 25,000A For BNC Adapter: 1A to 25,000A</p> <p>NOTE: This screen does not appear if no probe is connected to the PEL 103. If you want to configure the CT PRI setting in a PEL with no probes connected, you must use the DataView PEL Control Panel.</p>
5	«AGG.PERIOD» Aggregation period	Displays the aggregation period in minutes (1, 2, 3, 4, 5, 6, 10, 12, 15, 20, 30, 60)

Table 9

4. PEL CONTROL PANEL - DATAVIEW® SOFTWARE

 For contextual information on using DataView, refer to the Help Menu within the software.

4.1 Installing DataView

When you purchase the instrument, the product package includes a USB thumb drive containing DataView program files. To begin installation:

1. Insert the DataView thumb drive into an available USB port on your computer. If Autorun is enabled, an AutoPlay window appears on your screen. Click “Open folder to view files” to display the DataView folder. If Autorun is not enabled or allowed, use Windows Explorer to locate and open the USB drive labeled “DataView.”
2. When the DataView folder is open, find the file Setup.exe located in the root directory of the USB drive, and double-click it to run the installation program.
3. The DataView setup screen appears.

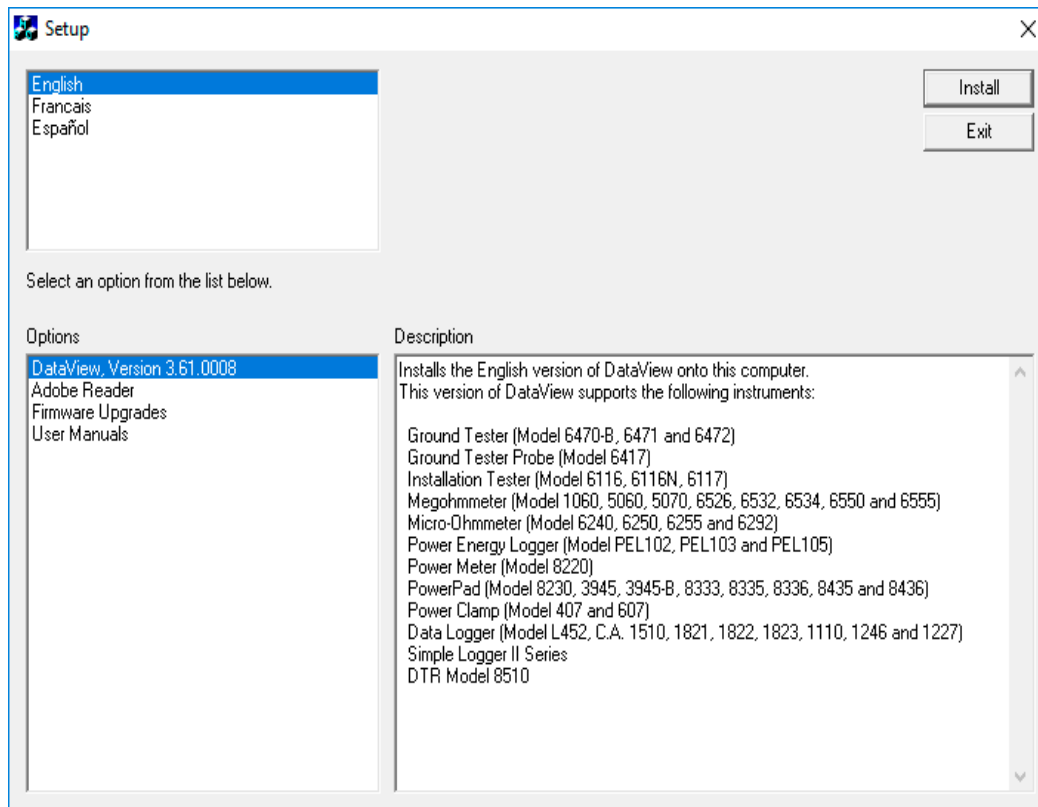

Figure 29

In the upper left corner of the screen, choose the language version of the Setup interface. (All Setup screens and dialogs will immediately appear in the selected language.)

In the lower left corner are the available installation options. In addition to the DataView software, you can select “Adobe Reader.” This links to the Adobe web site where you can download the latest version of Reader. This program is required to view DataView .pdf documents. The option Firmware Upgrades links to the website where you can check for new firmware updates for the PEL. Finally, User Manuals displays a list of .pdf files contained in the USB drive that accompanies DataView. (DataView also comes with a Help system that is installed with the program files.)

To install DataView, select DataView in the Options list and click Install.

4. Select the language version of DataView you want to install (English, French, or Spanish) then click Next. (By default, the language selected in step 3 is highlighted.)

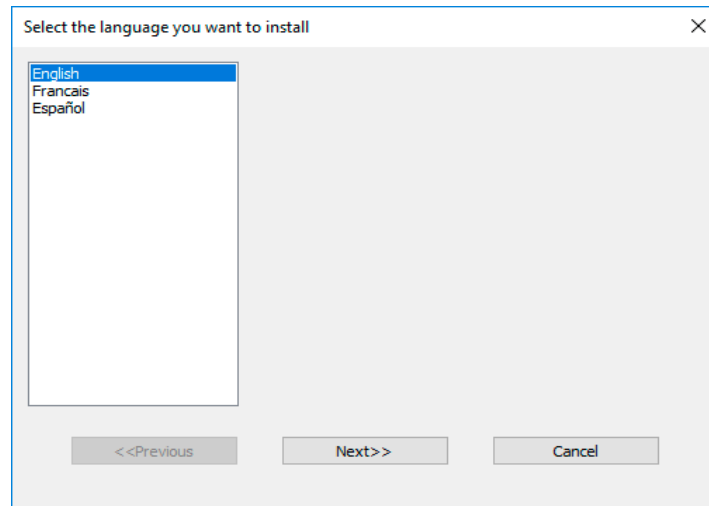

Figure 30

5. You are now prompted to select the software you want to install.

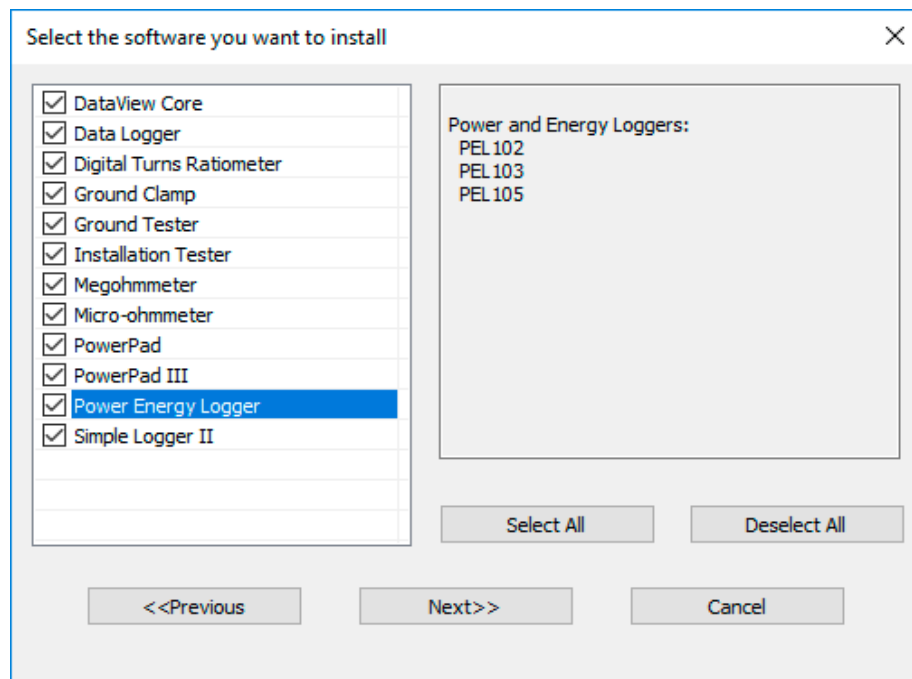

Figure 31

Each AEMC product family has its own specially designed Control Panel. If you are performing a Complete install, by default all available Control Panels are selected (a check mark next to the Control Panel indicates it is selected). Control Panels take up disk space on the computer; so unless you have other types of AEMC instruments, we recommend that you select Power Energy Logger and deselect the rest. You should also check the option DataView Core, which is a requirement if you plan to create DataView reports.

After you finish selecting and deselecting Control Panels and/or DataView Core, click Next.

6. The Setup program now informs you that it is ready to install DataView. If you want to review any of your previous selections, click the Previous button to return to earlier screens. Otherwise, click Install to begin installation.
7. The InstallShield program installs the selected software. If an earlier version of the software is already installed on your computer, for each selected program the InstallShield program will:
 - (a) Ask you to confirm the installation of the program. Click Next.
 - (b) Display a status bar indicating the progress of the installation.
 - (c) Inform you when the program is installed. Click Finish to install the next selected program.

If the software is not installed (or if the installed software is the same version as the selected software), the software is installed without requesting confirmation.

When all programs are installed, a message appears informing you of this. Click Finish to return to the Setup screen

8. You can now select additional Setup options to install (see step 3 above). When finished, click Exit.
9. The DataView folder now appears on your computer desktop, within which is the PEL Control Panel icon  and the icon(s) for any other Control Panel(s) you have installed.

4.2 PEL Control Panel

Clicking the DataView icon in the DataView folder on your desktop opens the core DataView program. Clicking the PEL Control Panel icon opens the PEL Control Panel:

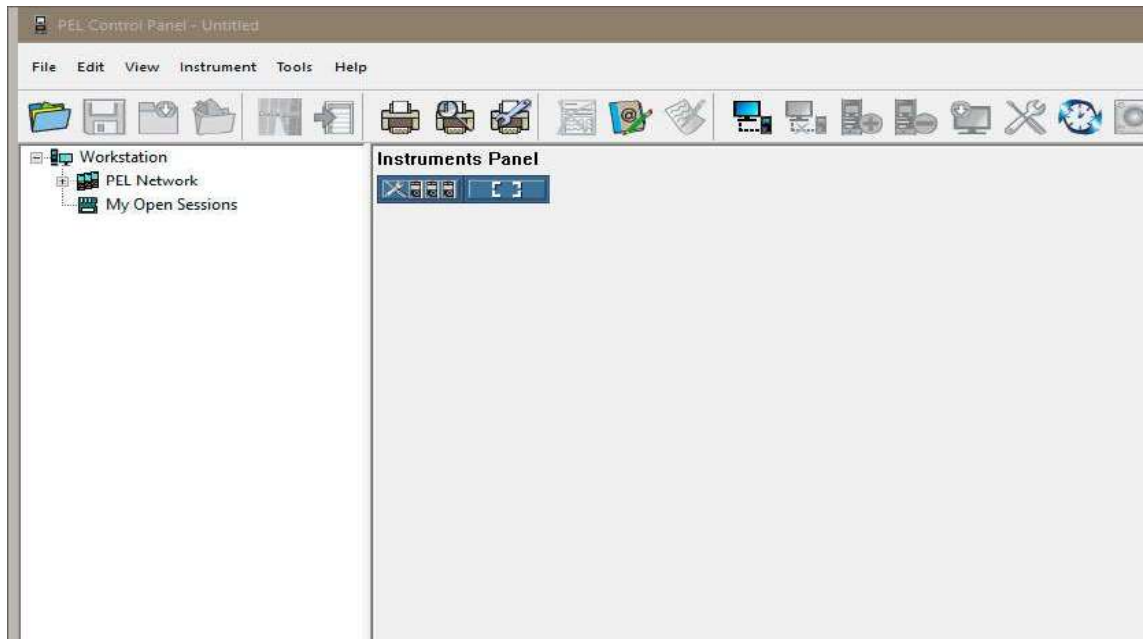

Figure 32

In general, core DataView features are for creating, viewing, editing, and storing DataView reports; while the PEL Control Panel is for connecting to, configuring, viewing measurements on, and downloading data from the instrument. You can access all DataView features through either the DataView icon or the Control Panel icon. For users who interact with PEL 100 series instruments, we recommend primarily using the PEL Control Panel. However, there are situations where using the core DataView icon may be more convenient for some users, such as when viewing multiple archived reports from different AEMC product families.

For further information about using the PEL Control Panel, consult the Help system that comes with the product. Access this Help by clicking the option Help in the PEL Control Panel's menu bar at the top of the screen.

4.3 Power & Energy Logger (PEL) Android App

Another way to connect to a PEL instrument is through the Power & Energy Logger (PEL) Android app. This app, which can be downloaded free from the Google Play Store (<https://play.google.com/store/apps/details?id=com.aemc.pel&hl=en>) enables you to work with a PEL instrument from an Android mobile device. Android is a platform for “touch screen” mobile devices such as tablets and smartphones. Introduced in 2007, Android has grown to become the most popular mobile operating system in the world, with over one billion devices sold globally.

The PEL app connects to the PEL via Bluetooth. And if the PEL is connected to a LAN network, you can also communicate with the instrument over Wi-Fi.

The PEL app provides a substantial subset of the functionality provided by the PEL Control Panel. For example, you can view data currently being measured by the instrument in real-time. This includes the type of distribution system currently being measured, and (for AC systems) the phasor diagram appropriate for this setup. Real-time data is organized in tables of related measurements for quick navigation and reference, and updated continuously from the instrument.

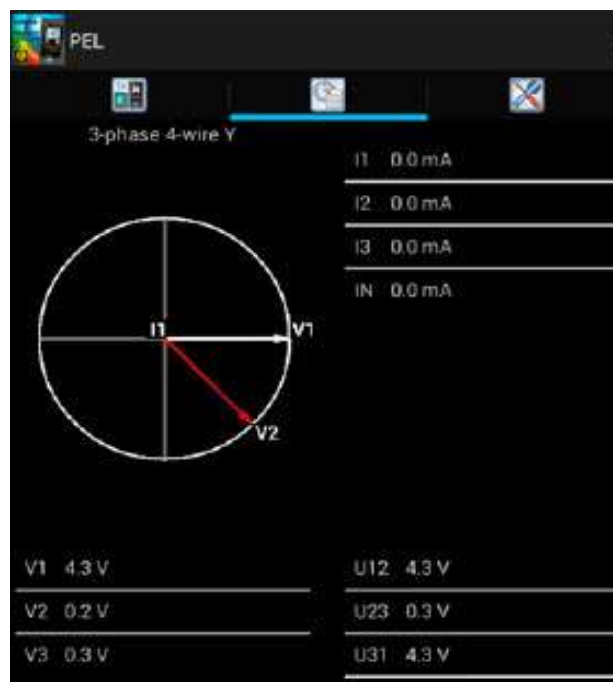

Figure 33

These data tables, which can require several pages to display, depend on the current distribution system. Different data appears for different distribution systems; the above example shows the first page of real-time data for a 3-phase 4-wire system.

You can also set parameters to schedule a recording session and specify what data will be recorded. This can be a recording that starts immediately, or at a future date and time. You can also choose which data to record. Recorded data is stored on the PEL instrument, where it can subsequently be downloaded to a PC and analyzed in detail using DataView.

In addition, you can view and/or set configuration variables on the PEL instrument. The PEL Android app enables you to review the current configuration settings on your PEL, and change these settings as required. You can change the type of distribution system being measured, voltage ratios, nominal frequency, current sensors options, communication-related settings, and other information related to the instrument and its operation.

The app is provided with a complete online Help system, which can be viewed independently at <http://www.pel100.us/help-en/index.html>. Consult this Help system for a complete description of the PEL app and all its capabilities.

5. SPECIFICATIONS

5.1 Reference Conditions

Parameter	Reference Conditions
Ambient temperature	73 °F (23 °C) ± 2 °F/C
Relative humidity	(45 to 75) % RH
Voltage	No DC component in AC, no AC component in DC (< 0.1 %)
Current	No DC component in AC, no AC component in DC (< 0.1 %)
Phase voltage	(100 to 1000) Vrms, without DC (< 0.5 %)
Input voltage of current inputs (except AmpFlex®/MiniFlex®)	50 m V to 1.2 V without DC (< 0.5 %) for AC measurement, without AC (< 0.5 %) for DC measurement
Harmonics	< 0.1 %
Voltage unbalance	0 %
Preheating	Device powered for at least an hour
Common mode	Neutral input and enclosure are held at earth potential
	Instrument powered on battery, USB disconnected
Magnetic field	0 A/m AC
Electric field	0 V/m AC

Table 10

5.2 Electrical Specifications

5.2.1 Voltage Inputs

Operating Range: up to 1000 Vrms for phase-to-neutral voltages
up to 1700 Vrms for phase-to-phase voltages

 **NOTE:** Phase-to-neutral voltages lower than 2 V and phase-to-phase voltages lower than $2\sqrt{3}$ are zeroed.

Input Impedance: 1908 k Ω (phase-to-neutral and neutral-to-earth/ground)

Max Overload: 1100 Vrms

5.2.2 Current Inputs

 **NOTE:** Current sensor inputs are “voltage” inputs (current probes have a voltage output).

Operating Range: 0.5 mV to 1.2 V (1 V = I_{nom}) with crest factor = $\sqrt{2}$

Input Impedance: 1 M Ω (except for AmpFlex®/MiniFlex® current sensors)
12.4 k Ω (AmpFlex®/MiniFlex® current sensors)

Max Overload: 1.7 V

5.2.3 Accuracy Specifications (excluding current sensors)

5.2.3.1 Specifications at 50/60 Hz

Quantity	Measurement Range	Intrinsic Uncertainty
Frequency (f)	42.5 Hz to 69 Hz	± 0.1 Hz
Phase to neutral voltage (V)	10 V to 100 V	$\pm 0.2\% \pm 0.2$ V **
	100 V to 1000 V	$\pm 0.2\% \pm 0.2$ V
Phase to phase voltage (U)	17 V to 170 V	$\pm 0.2\% \pm 0.4$ V **
	170 V to 1700 V	$\pm 0.2\% \pm 0.4$ V
Current (I) independent of current sensor *	(0.2 to 5) % Inom	$\pm 0.2\% \pm 0.02\%$ Inom **
	(5 to 120) % Inom	$\pm 0.2\% \pm 0.02\%$ Inom
Active power (P)	PF = 1 V = 100 to 1000 V I = (5 to 120) % Inom	$\pm 0.5\% \pm 0.005\%$ Pnom
	PF = [0.5 inductive ; 0.8 capacitive] V = 100 to 1000 V I = (5 to 120) % Inom	$\pm 0.7\% \pm 0.007\%$ Pnom
Reactive power (Q)	Sin ϕ = 1 V = 100 to 1000 V I = (5 to 120) % Inom	$\pm 1\% \pm 0.01\%$ Qnom
	Sin ϕ = [0.5 inductive ; 0.5 capacitive] V = 100 to 1000 V I = (5 to 120) % Inom	$\pm 1\% \pm 0.015\%$ Qnom
	Sin ϕ = [0.5 inductive ; 0.5 capacitive] V = 100 to 1000 V I = (5 to 120) % Inom	$\pm 1.5\% \pm 0.015\%$ Qnom
	Sin ϕ = [0.25 inductive ; 0.25 capacitive] V = 100 to 1000 V I = (5 to 120) % Inom	$\pm 3.5\% \pm 0.003\%$ Qnom
Apparent power (S)	V = 100 to 1000 V I = (5 to 120) % Inom	$\pm 0.5\% \pm 0.005\%$ Snom
Power factor (PF)	PF = [0.5 inductive ; 0.5 capacitive] V = 100 to 1000V I = (5 to 120) % Inom	± 0.05
	PF = [0.2 inductive ; 0.2 capacitive] V = 100 to 1000V I = (5 to 120) % Inom	± 0.1
Tan Φ	Tan Φ = [$\sqrt{3}$ inductive ; $\sqrt{3}$ capacitive] V = 100 to 1000 V I = (5 to 120) % Inom	± 0.02
	Tan Φ = [3.2 inductive ; 3.2 capacitive] V = 100 to 1000 V I = (5 to 120) % Inom	± 0.05
Active energy (Ep)	PF = 1 V = 100 to 1000 V I = (5 to 120) % Inom	$\pm 0.5\%$
	PF = [0.5 inductive ; 0.8 capacitive] V = 100 to 1000 V I = (5 to 120) % Inom	$\pm 0.6\%$

Quantity	Measurement Range	Intrinsic Uncertainty
Reactive energy (Eq)	$\text{Sin } \varphi = 1$ $V = 100 \text{ to } 1000 \text{ V}$ $I = (5 \text{ to } 120) \% I_{nom}$	$\pm 2 \%$
	$\text{Sin } \varphi = [0.5 \text{ inductive ; } 0.5 \text{ capacitive}]$ $V = 100 \text{ to } 1000 \text{ V}$ $I = (5 \text{ to } 120) \% I_{nom}$	$\pm 2 \%$
	$\text{Sin } \varphi = [0.5 \text{ inductive ; } 0.5 \text{ capacitive}]$ $V = 100 \text{ to } 1000 \text{ V}$ $I = (5 \text{ to } 120) \% I_{nom}$	$\pm 2.5 \%$
	$\text{Sin } \varphi = [0.25 \text{ inductive ; } 0.25 \text{ capacitive}]$ $V = 100 \text{ to } 1000 \text{ V}$ $I = (5 \text{ to } 120) \% I_{nom}$	$\pm 2.5 \%$
Apparent energy (Es)	$V = 100 \text{ to } 1000 \text{ V}$ $I = (5 \text{ to } 120) \% I_{nom}$	$\pm 0.5 \%$
Harmonics number (1 to 25)	$PF = 1$ $V = 100 \text{ to } 1000 \text{ V}$ $I = (5 \text{ to } 120) \% I_{nom}$	$\pm 1 \%$
Total Harmonic Distortion (THD)	$PF = 1$ $V = 100 \text{ to } 1000 \text{ V}$ $I = (5 \text{ to } 120) \% I_{nom}$	$\pm 1 \%$

Table 11

- *Inom* is the value of the measured current for a current sensor output of 1 V. See Table 23 for the nominal current values.
- *Pnom* and *Snom* are the active power and apparent power for $V = 1000 \text{ V}$, $I = I_{nom}$ and $PF = 1$.
- *Qnom* is the reactive power for $V = 1000 \text{ V}$, $I = I_{nom}$, and $\text{Sin } \varphi = 1$.
- * The intrinsic uncertainty for input current (*I*) is specified for an isolated input voltage of $1 \text{ V} = I_{nom}$. The intrinsic uncertainty of the connected current sensor should be added to this intrinsic uncertainty to determine the total intrinsic uncertainty. In the case of using sensors AmpFlex® and MiniFlex®, intrinsic uncertainty is given in Table 24.
The intrinsic uncertainty for neutral current is the maximum intrinsic uncertainty on I1, I2 and I3.
- ** Indicative maximum value of the intrinsic uncertainty. Higher uncertainties can be noted, in particular with EMI.

5.2.3.2 Specifications @ 400 Hz

Quantity	Measurement Range	Intrinsic Uncertainty
Frequency (F)	340 Hz to 460 Hz	± 0.1 Hz
Phase to neutral voltage (V)	10 V to 100 V	± 0.5 % ± 0.5 V **
	100 V to 600 V	± 0.5 % ± 0.5 V
Phase to phase voltage (U)	17 V to 170 V	± 0.5 % ± 0.5 V **
	170 V to 1700 V	± 0.5 % ± 0.5 V
Current (I) independent of current sensor *	(0.2 to 5) % Inom	± 0.5 % ± 0.05 % Inom **
	(5 to 120) % Inom ***	± 0.5 % ± 0.05 % Inom
Active power (P)	PF = 1 V = 100 to 600 V I = (5 to 120) % Inom	±2 % ± 0.02 % Pnom **
	PF = [0.5 inductive ; 0.8 capacitive] V = 100 to 600 V I = (5 to 120) % Inom	±3 % ± 0.03 % Pnom **
Active energy (Ep)	PF = 1 V = 100 to 600 V I = (5 to 120) % Inom	± 2 % **

Table 12

- Inom is the value of the measured current for a current sensor output at 50/60 Hz. See Table 23 for the nominal current values.
- Pnom is the active power for V = 600 V, I = Inom and PF = 1.
- * The intrinsic uncertainty for input current (I) is specified for an isolated input voltage of 1 V = Inom. The intrinsic uncertainty of the connected current sensor should be added to this intrinsic uncertainty to determine the total intrinsic uncertainty. In the case of using sensors AmpFlex® and MiniFlex®, intrinsic uncertainty is given in Table 24. The intrinsic uncertainty for neutral current is the maximum intrinsic uncertainty on I1, I2 and I3.
- ** Indicative maximum value of the intrinsic uncertainty. Higher uncertainties can be noted, in particular with EMI.
- *** For AmpFlex® and MiniFlex®, the maximum current is limited to 60 % Inom at 50/60 Hz, because of higher sensitivity.

5.2.3.3 Specifications @ DC

Quantity	Measurement Range	Typical Intrinsic Uncertainty **
Voltage (V)	V = 100 V to 1000 V	± 1 % ± 3 V
Current (I) independent of current sensor *	I = (5 to 120) % Inom	± 1 % ± 0.3 % Inom
Power (P)	V = 100 to 1000 V I = (5 to 120) % Inom	± 1 % ± 0.3 % Pnom
Energy (Ep)	V = 100 to 1000 V I = (5 to 120) % Inom	± 1.5 %

Table 13

- Inom is the value of the measured current for a current sensor output of 1 V. See Table 23 for the nominal current values.
- Pnom is the power for V = 1000 V and I = Inom.
- * The intrinsic uncertainty for input current (I) is specified for an isolated input voltage of 1 V = Inom. The intrinsic uncertainty of the connected current sensor should be added to this intrinsic uncertainty to determine the total intrinsic uncertainty. In the case of using sensors AmpFlex® and MiniFlex®, intrinsic uncertainty is given in Table 24.
- The intrinsic uncertainty for neutral current is the maximum intrinsic uncertainty on I1, I2 and I3.
- ** Indicative maximum value of the intrinsic uncertainty. Higher uncertainties can be noted, in particular with EMI.

5.2.3.4 Temperature

For V, U, I, P, Q, S, FP and E:

- 300 ppm / °C, with 5 % < I < 120 % and PF = 1
- 500 ppm / °C, with 10 % < I < 120 % and PF = 0.5 inductive
- Typical DC offset V: 10 mV / °C
I: 30 ppm x Inom / °C

5.2.3.5 Common Mode Rejection

The common mode rejection ratio on neutral input is typically 140 dB. For example, 110 V applied on the neutral input will add 11 μ V to AmpFlex®/MiniFlex® values, which is a 230 mA error at 60 Hz. A voltage of 110 V applied on the neutral input will add 11 μ V to other current sensors' values, resulting in an additional of 0.01 % I_{nom} .

5.2.3.6 Magnetic Field Influence

For Rogowski inputs (without sensors): 10 mA/A/m typical at 50/60 Hz.

5.2.4 Current Sensors

5.2.4.1 Precautions for Use

Refer to the safety sheet or user manual that was supplied with your current sensors for more information.

5.2.4.2 Use and Characteristics

Current clamps and flexible current sensors are used to measure the current flowing in a cable without opening the circuit. They also insulate the user from dangerous voltages in the circuit.

- The choice of current sensor to be used depends on the current to be measured and the diameter of the cables.
- When installing current sensors, face the arrow on the probe or the sensor in the direction of the load.

5.2.4.3 MiniFlex® MA193 & MA194

The Flexible Current Sensor MiniFlex® Model MA193 can be used to measure the current in a cable without opening the circuit. It also serves to isolate the user from hazardous voltages in the circuit. This sensor can only be used as an accessory of an instrument. Before connecting it, if you have several sensors, you can mark each of them using one of the color-coded ID markers supplied with the instrument to identify the phase. Then connect the sensor to the instrument.

- Press the yellow opening device to open the Flexible coil. Then, place it around the conductor through which the current to be measured flows (only one conductor in the sensor).
- Close the coil. In order to optimize measurement quality, it is best to center the conductor in the coil and make the shape of the coil as circular as possible.
- To disconnect the coil, open it and withdraw it from the conductor. Then, disconnect the sensor from the instrument.

MiniFlex® MA193 & MA194	
Nominal Range	(100/400/2000/10,000) AAC
Measurement Range	200 mA to 3000 AAC
Sensor	MA193-10-BK: Length = 10 in (250 mm); \varnothing = 2.75 in (70 mm) MA193-14-BK: Length = 14 in (350 mm); \varnothing = 3.9 in (100 mm) MA194-24-BK: Length = 24 in (609 mm); \varnothing = 7.4 in (190 mm)
Variation of the position of the conductor in the sensor	\leq 1.5 % typical, 2.5 % max
Adjacent conductor carrying alternating current	\leq 1 % for a conductor in contact with sensor and \leq 2% near the snap device
Safety	EN 61010-2-032, Pollution Degree 2, 600 V CAT IV, 1000 V CAT III

Table 14

NOTE: Currents $<$ 0.05 % of the nominal range (100, 400, 2000 or 10,000) A will be displayed as zero.

The nominal ranges are reduced to (50/200/1000/5000) AAC at 400 Hz. MiniFlex® will operate when 10,000 A is selected.

5.2.4.4 Other Current Sensors

The measurement ranges are those of the sensors. In some cases, they may differ from the ranges that can be measured by the PEL. For use, see the manual distributed with the current sensor

NOTE: Power calculations will be zeroed when the current is zeroed.

Model MR193	
Nominal Range	1000 AAC, 1400 ADC max
Measurement Range	1 A to 1000 AAC, (10 to 1300) A _{PEAK} AC+DC
Maximum Clamping Diameter	One 1.6 in (42 mm) or two 0.98 in (25.4 mm) or two bus bars (1.96 x 0.19) in (50 x 5) mm
Variation of the position of the conductor in the sensor	< 0.5 % DC to 440 Hz
Adjacent conductor carrying alternating current	< 10 mA/A at 50/60 Hz
Safety	EN 61010-2-032, Pollution Degree 2, 300 V CAT IV, 600 V CAT III

Table 15

NOTE: Currents < 1 AAC/DC will be displayed as zero.

Model SR193	
Nominal Range	1000 AAC for $f \leq 1$ kHz
Measurement Range	1 to 1200 AAC max ($I > 1000$ A not continuously)
Maximum Clamping Diameter	2 in (52 mm)
Variation of the position of the conductor in the sensor	< 0.5 % DC to 440 Hz
Adjacent conductor carrying alternating current	< 10 mA/A at 50/60 Hz
Safety	EN 61010-2-032, Pollution Degree 2, 600 V CAT IV, 1000 V CAT III

Table 16

NOTE: Currents < 0.5A will be displayed as zero.

AmpFlex® Sensors	
Nominal Range	(100/400/2000/10,000) AAC
Measurement Range	50 mA to 12000 AAC
Sensor	Length = 24 in (610 mm); $\varnothing = 7.64$ in (190 mm) Length = 36 in (910 mm); $\varnothing = 11.46$ in (290 mm)
Variation of the position of the conductor in the sensor	≤ 2 % any position and ≤ 4 % near snap device
Adjacent conductor carrying alternating current	≤ 1 % any position and ≤ 2 % near snap device
Safety	EN 61010-2-032, Pollution Degree 2, 600 V CAT IV, 1000 V CAT III

Table 17

NOTE: Currents < 0.05 % for nominal range (100, 400, 2000 or 10,000) A will be displayed as zero. The nominal ranges are reduced to (50/200/1000/5000) AAC at 400 Hz.

Model MN93	
Nominal Range	200 AAC for $f \leq 1$ kHz
Measurement Range	0.5 A to 240 AAC max ($I > 200$ A not permanent)
Maximum Clamping Diameter	0.8 in (20 mm)
Variation of the position of the conductor in the sensor	< 0.5 % at 50/60 Hz
Adjacent conductor carrying alternating current	≤ 15 mA/A
Safety	EN 61010-2-032, Pollution Degree 2, 300 V CAT IV, 600 V CAT III

Table 18

NOTE: Currents < 0.1 A will be displayed as zero.

Model MN193	
Nominal Range	5 A and 100 AAC
Measurement Range	5 A: (0.005 to 6) AAC max 100 A: (0.2 to 120) AAC max
Maximum Clamping Diameter	0.8 in (20 mm)
Variation of the position of the conductor in the sensor	< 0.5 % at 50/60 Hz
Adjacent conductor carrying alternating current	≤ 15 mA/A at 50/60 Hz
Safety	EN 61010-2-032, Pollution Degree 2, 300 V CAT IV, 600 V CAT III

Table 19

The 5 A range of the MN193 is designed to work with secondary current transformers.

NOTE: Currents < 2.5 mA x ratio on the 5 A range and < 0.05 A on the 100 A range will be displayed as zero with this probe.

Model SL261	
Nominal Range	10 A and 100 AAC/DC
Measurement Range	100 mV/A: 100 mA to 10 A peak 10 mV/A: 1 to 100 A peak
Probe Output Signal	1000 mV peak max
Maximum Clamping Diameter	0.46 in (11.8 mm)
Variation of the position of the conductor in the sensor	< 0.5 %
Adjacent conductor carrying alternating current	-33 dB typical, DC to 1 kHz
Safety	EN 61010-2-032, Pollution Degree 2, 600 V CAT III

Table 20

5A Adapter Box /Essailec® adapter	
Nominal Range	5 AAC
Measurement Range	250 mAac to 6 AAC
Probe Output Signal	200 mVac/AAC
Number of transformer inputs	3
Safety	EN 61010-2-032, Pollution degree 2, 300 V CAT III

Table 21

NOTE: Currents < 2.5 mA will be displayed as zero.

5.2.4.5 Accuracy

The RMS current measurement accuracy and the phase accuracy correspond to addition values (which must therefore be added to the instrument's accuracy), indicated as influences on the calculations carried out by the instrument (powers, energies, power factors, tangents, etc.).

The following specifications are considered to be in the conditions of references of the current sensor.

Current sensors with 1 V output at Inom specifications

Model	I nominal	Current (RMS or DC)	Intrinsic uncertainty at 50/60 Hz	Intrinsic uncertainty on ϕ at 50/60 Hz	Typical uncertainty on ϕ at 50/60 Hz	Typical uncertainty on ϕ at 400 Hz
MR193	1000 ADC	(1 to 50) A	$\pm 1.5 \% \pm 1 \text{ A}^{**}$	-	-	- 4.5 ° @ 100 A
		(50 to 100) A	$\pm 1.5 \% \pm 1 \text{ A}$	$\pm 2.5^\circ$	-0.9 °	
		(100 to 800) A	$\pm 2.5 \%$	$\pm 2^\circ$	- 0.8 °	
		(800 to 1000) A	$\pm 4 \%$		- 0.65 °	
SR193	1000 AAC	(1 to 50) A	$\pm 1 \%^{**}$	-	-	+ 0.1 ° @ 1000 A
		(50 to 100) A	$\pm 0.5 \%$	$\pm 1^\circ$	+ 0.25 °	
		(100 to 1200) A	$\pm 0.3 \%$	$\pm 0.7^\circ$	+ 0.2 °	
MN93	200 AAC	(0.5 to 5) A	$\pm 3 \% \pm 1 \text{ A}^{**}$	-	-	-
		(5 to 40) A	$\pm 2.5 \% \pm 1 \text{ A}$	$\pm 5^\circ$	+ 2 °	- 1.5 ° @ 40 A
		(40 to 100) A	$\pm 2 \% \pm 1 \text{ A}$	$\pm 3^\circ$	+ 1.2 °	- 0.8 ° @ 100 A
		(100 to 240) A	$\pm 1 \% + 1 \text{ A}$	$\pm 2.5^\circ$	$\pm 0.8^\circ$	- 1 ° @ 200 A
MN193	100 AAC	200 mA to 5A	$\pm 1 \% \pm 2 \text{ mA}^{**}$	$\pm 4^\circ$	-	-
		(5 to 120) A	$\pm 1 \%$	$\pm 2.5^\circ$	+ 0.75 °	- 0.5 ° @ 100 A
	5 AAC	(5 to 250) mA	$\pm 1.5 \% \pm 0.1 \text{ mA}^{**}$	-	-	-
		255 mA to 6A	$\pm 1 \%$	$\pm 5^\circ$	+ 1.7 °	- 0.5 ° @ 5 A
SL261	100 AAC/DC	(5 to 40) A	$\pm 4 \% \pm 50 \text{ mA}$	$\pm 1^\circ$	-	-
		(40 to 100) A	$\pm 15 \%$	$\pm 1^\circ$	-	-
	10 AAC/DC	50 mA to 10 A	$\pm 3 \% \pm 50 \text{ mA}$	$\pm 1.5^\circ$	-	-
5 A Adapter	5 AAC	(5 to 250) mA	$\pm 0.5 \% \pm 2 \text{ mA}^{**}$	-	-	-
		250 mA to 6 A	$\pm 0.5 \% \pm 1 \text{ mA}$	$\pm 0.5^\circ$	-	-

Table 22

** Indicative maximum value of the intrinsic uncertainty. Higher uncertainties can be noted, in particular, with EMI.

AmpFlex® and MiniFlex® Specifications

Sensor type	I nominal	Current (RMS or DC)	Typical intrinsic uncertainty at 50/60 Hz	Intrinsic uncertainty at 400 Hz	Intrinsic uncertainty on φ at 50/60 Hz	Typical uncertainty on φ at 400 Hz
AmpFlex® A193 *	100 AAC	200 mA to 5 A	± 1.2 % ± 50 mA **	± 2 % ± 0.1 A **	-	-
		(5 to 120) A *	± 1.2 % ± 50 mA	± 2 % ± 0.1 A	± 0.5 °	- 0.5 °
	400 AAC	(0.8 to 20) A	± 1.2 % ± 0.2 A **	± 2 % ± 0.4 A **	-	-
		(20 to 500) A *	± 1.2 % ± 0.2 A	± 2 % ± 0.4 A	± 0.5 °	- 0.5 °
	2000 AAC	(4 to 100) A	± 1.2 % ± 1 A **	± 2 % ± 2 A **	-	-
		(100 to 2400) A *	± 1.2 % ± 1 A	± 2 % ± 2 A	± 0.5 °	- 0.5 °
10,000 AAC	(20 to 500) A	± 1.2 % ± 5 A **	± 2 % ± 10 A **	-	-	
	(500 to 12,000) A *	± 1.2 % ± 5 A	± 2 % ± 10 A	± 0.5 °	- 0.5 °	
MiniFlex® MA193 * MA194 *	100 AAC	200 mA to 5 A	± 1.2 % ± 50 mA **	± 2 % ± 0.1 A **	-	-
		(5 to 120) A *	± 1.2 % ± 50 mA	± 2 % ± 0.1 A	± 0.5 °	- 0.5 °
	400 AAC	(0.8 to 20) A	± 1.2 % ± 0.2 A **	± 2 % ± 0.4 A **	-	-
		(20 to 500) A *	± 1.2 % ± 0.2 A	± 2 % ± 0.4 A	± 0.5 °	- 0.5 °
	2000 AAC	(4 to 100) A	± 1.2 % ± 1 A **	± 2 % ± 2 A **	-	-
		(100 to 2400) A *	± 1.2 % ± 1 A	± 2 % ± 2 A	± 0.5 °	- 0.5 °
3000 AAC	(20 to 500) A	± 1.2 % ± 5 A **	± 2 % ± 10 A **	-	-	
	(500 to 3000) A *	± 1.2 % ± 5 A	± 2 % ± 10 A	± 0.5 °	- 0.5 °	

Table 23

* The nominal ranges are reduced to (50/200/1000/5000) AAC at 400 Hz.

** Indicative maximum value of the intrinsic uncertainty. Higher uncertainties can be noted, in particular with EMI.

NOTE: When no current sensor is connected, the current values are forced to zero.

Distribution system	Abbreviation	I ₁	I ₂	I ₃
Split phase (1-phase 2-wire)	1P-2W	•	-	-
Split phase (1-phase 3-wire)	1P-3W	•	•	-
3-phase 3-wire Δ	3P-3WΔ2	•	-	•
3-phase 3-wire Open Δ	3P-3W02	•	-	•
3-phase 3-wire Y 2	3P-3WY2	•	-	•
3-phase 3-wire Δ	3P-3WΔ3	•	•	•
3-phase 3-wire Open Δ	3P-3W03	•	•	•
3-phase 3-wire Y	3P-3WY	•	•	•
3-phase 3-wire Δ balanced	3P-3WΔB	-	-	•
3-phase 4-wire Y	3P-4WY	•	•	•
3-phase 4-wire Y balanced	3P-4WYB	•	-	-
3-phase 4-wire Y 2½	3P-4WY2	•	•	•
3-phase 4-wire Δ	3P-4WΔ	•	•	•
3-phase 4-wire Open Δ	3P-4W0Δ	•	•	•
DC 2-wire	DC-2W	•	-	-
DC 3-wire	DC-3W	•	•	-
DC 4-wire	DC-4W	•	•	•

5.3 Bluetooth

Bluetooth 2.1

- Class 1 range: 328 ft (100 m) n Nominal sensitivity: -82 dBm
- Nominal output power: +15 dBm n Rate : 115.2 kbits/s

5.4 Power Supply

AC Power (external power supply) - Overvoltage CAT II

- **Operating Range:** 110 V / 230 V ($\pm 10\%$) @ 50 / 60 Hz
- **Max Power:** 15 VA (rated to 30 VA max)

Battery Power

- **Type:** Rechargeable NiMH battery
- **Charge Time:** 5 hours approx
- **Recharging Temperature:** (50 to 104) °F (10 to 40) °C



NOTE: Configuration data is saved for up to 5 years during a low battery condition.
When the instrument is off, the real-time clock is maintained for two weeks or longer.

Autonomy

- 30 minutes minimum
- 60 minutes typical

5.5 Mechanical Specifications

Dimensions: (10.08 x 4.92 x 1.46) in (256 x 125 x 37) mm

Weight: < 1 kg

Drop Test: 1 m in the most severe position without permanent mechanical damage and functional deterioration

Degrees of Protection: Provided by enclosure (IP code) according to IEC 60529

IP 54 instrument not connected (de-energized) / not including the terminals
IP20 instrument connected (operating)

5.6 Environmental Specifications

Reference Temperature: (20 to 26) °C (68 to 78.8) °F from (45 to 75) % RH

Operating Temperature: (0 to 42.5) °C (32 to 108.5) °F from (10 to 85) % RH
(0 to 50) °C (32 to 122) °F from (45 to 75) % RH

Storage Temperature:

With batteries: (-20 to 35) °C (-4 to 95) °F from (0 to 95) % RH
(-20 to 50) °C (-4 to 122) °F from (0 to 75) % RH

Without batteries: (-20 to 70) °C (-4 to 158) °F from (0 to 75) % RH

Recharging Temperature: n/a

Altitude: Operating: 0 to 2000 m (6560 ft); Non-Operating: 0 to 10000 m (32800 ft)

5.7 Safety Specifications

Electrical Safety

The instrument complies with IEC 61010-1, and IEC 61010-2-030 for the following:

- Measurement inputs and enclosure: 600 V CAT IV / 1000 V CAT III, pollution degree 2
- Power supply: 300 V overvoltage category II, pollution degree 2



Conforms to UL Std. UL 61010-1
Conforms to UL Std. UL 61010-2-030
Cert. to CAN/CSA Std. C22.2 No. 61010-1
Cert. to CSA Std. C22.2#61010-2-030

For current sensors, see § 5.2.4.4

The current sensors comply with IEC 61010-2-032

The test leads and alligator clips comply with IEC 61010-031

5.8 Electromagnetic Compatibility

- Emissions and immunity in an industrial setting compliant with IEC 61326-1 (with an influence of 0.5 % typical of the full scale)

Specifications are subject to change without notice.

6. MAINTENANCE

6.1 Battery

Your instrument is equipped with a NiMH battery. This technology offers several advantages:

- Long battery charge life for a limited volume and weight.
- Possibility of quickly recharging your battery.
- Significantly reduced memory effect: you can recharge your battery even if it is not fully discharged.
- Respect for the environment: no pollutant materials such as lead or cadmium, in compliance with the applicable regulations.

After prolonged storage, the battery may be completely discharged. If so, it must be completely recharged.

Your instrument may not function during part of this recharging operation.

Full recharging of a completely discharged battery may take several hours.

 In this case, at least 5 charge/discharge cycles will be necessary for your battery to recover 95 % of its capacity.

To make the best possible use of your battery and extend its effective service life:

- Only charge your instrument at temperatures between 50 °F and 104 °F (10 °C and 40 °C).
- Comply with the conditions of use defined in the operating manual.
- Comply with the storage conditions specified in the operating manual.

 Before first use, charge and discharge the instrument one or two cycles to ensure the proper level display of the battery indicator.

Note that if you are unsure about changing the battery, we recommend having this done at our Service Center as part of the PEL instrument's regular maintenance.

6.2 Battery Indicator

The Yellow/Red LED (see #6 Figure 8) is used to indicate the status of the battery.

When the power is on, the battery is charging until it is full.

- LED OFF: Battery full (with or without power supply).
- Yellow LED ON/No blinks: Battery is charging.
- Yellow LED blinks twice per second: Battery is recovering after a full discharge.
- Red LED blinks twice per second: Low battery (and no power supply).

6.3 Cleaning

 **Disconnect the instrument from any source of electricity.**

The instrument should be cleaned periodically to keep the LCD clear and prevent the buildup of dirt and grease around the instrument's buttons.

- Clean the body of the instrument with a damp and soapy cloth
- Do not submerge the instrument in water
- Do not use solvents

6.4 Updating the Firmware

The PEL 102 and 103 firmware controls the features and functionality of the instrument. AEMC provides firmware updates free of charge to download through our DataView PEL Control Panel software.

 **NOTE:** Updating the firmware could reset the configuration and cause loss of stored data. As a precaution, save the stored data to a computer before updating the firmware.

To update the firmware, your computer must be running DataView with the PEL Control Panel (V2.2.9665 or later).

1. Power ON the instrument using external power, to ensure the instrument remains ON throughout the update procedure. Also ensure that the battery is at least 50% charged. **Do not perform an update with the instrument running on battery power, or with low battery charge. If the instrument turns OFF while firmware updating is in progress, it could become inoperative. External power with a sufficiently charged battery for backup helps minimize the risk of power interruptions during updating.**
2. Connect the PEL instrument to the computer using the USB cable.
3. Launch the DataView PEL Control Panel.
4. Ensure the instrument is listed in the PEL Network navigation tree. If it is, skip this step and go to step 5 below. If not, click **Instrument** in the menu bar and select **Add an Instrument**, then connect the instrument using the Add an Instrument Wizard. (Press F1 if you need assistance.)
5. Ensure the instrument is listed with a green check next to its name, indicating it is connected. If not, select the instrument and click **Instrument > Reconnect Instrument**. When the instrument is connected, select it.
6. By default, the PEL Control Panel automatically checks the connected instrument's firmware. If it is out of date, the Firmware Update dialog box appears, listing the instrument and any others running out-of-date firmware. Click **Update** (or **Select All** to update multiple instruments). This displays the Firmware Upgrade dialog box listing the latest firmware revisions for the PEL DSP and microprocessor; proceed as instructed in Step 7 below.

If the PEL Control Panel option "Check automatically for new firmware for connected instruments upon start of program" has been previously de-selected, the automatic firmware check does not occur. In this case, click **Instrument** in the menu bar. This includes the option **Firmware Upgrade**. If the selected instrument is running the latest firmware, this option is grayed out and inactive. If the instrument is not running the latest firmware, click Firmware Upgrade to display the Firmware Upgrade dialog box.

7. Click the **Start** button to begin the update. During this process, status bars display the progress of the DSP and microprocessor firmware updates. (Note that if only one of these requires updating, only its status bar appears.)
8. When the firmware update is complete, click the **Close** button to exit.

6.5 Repair and Calibration

To ensure that your instrument meets factory specifications, we recommend that it be sent back to our factory Service Center at one-year intervals for recalibration or as required by other standards or internal procedure.

For instrument repair and calibration:

You must contact our Service Center for a Customer Service Authorization Number (CSA#). Send an email to repair@aemc.com requesting a CSA#, you will be provided a CSA Form and other required paperwork along with the next steps to complete the request. Then return the instrument along with the signed CSA Form. This will ensure that when your instrument arrives, it will be tracked and processed promptly. Please write the CSA# on the outside of the shipping container. If the instrument is returned for calibration, we need to know if you want a standard calibration or a calibration traceable to N.I.S.T. (includes calibration certificate plus recorded calibration data).

Ship To: Chauvin Arnoux®, Inc. d.b.a. AEMC® Instruments
15 Faraday Drive • Dover, NH 03820 USA
Phone: (800) 945-2362 (Ext. 360) / (603) 749-6434 (Ext. 360)
Fax: (603) 742-2346
E-mail: repair@aemc.com

(Or contact your authorized distributor.)

Contact us for the costs for repair, standard calibration, and calibration traceable to N.I.S.T.



NOTE: You must obtain a CSA# before returning any instrument.

6.6 Technical and Sales Assistance

If you are experiencing any technical problems, or require any assistance with the proper operation or application of your instrument, please call, e-mail or fax our technical support team:

Chauvin Arnoux®, Inc. d.b.a. AEMC® Instruments
Phone: (800) 343-1391 (Ext. 351)
Fax: (603) 742-2346
E-mail: techsupport@aemc.com
www.aemc.com

6.7 Limited Warranty

The instrument is warranted to the owner for a period of two years from the date of original purchase against defects in manufacture. This limited warranty is given by AEMC® Instruments, not by the distributor from whom it was purchased. This warranty is void if the unit has been tampered with, abused, or if the defect is related to service not performed by AEMC® Instruments.

Full warranty coverage and product registration is available on our website at: www.aemc.com/warranty.html.

Please print the online Warranty Coverage Information for your records.

What AEMC® Instruments will do:

If a malfunction occurs within the warranty period, you may return the instrument to us for repair, provided we have your warranty registration information on file or a proof of purchase. AEMC® Instruments will repair or replace the faulty material at our discretion.

REGISTER ONLINE AT: www.aemc.com/warranty.html

6.8 Warranty Repairs

What you must do to return an Instrument for Warranty Repair:

First, send an email to repair@aemc.com requesting a Customer Service Authorization Number (CSA#) from our Service Department. You will be provided a CSA Form and other required paperwork along with the next steps to complete the request. Then return the instrument along with the signed CSA Form. Please write the CSA# on the outside of the shipping container. Return the instrument, postage or shipment pre-paid to:

Ship To: Chauvin Arnoux®, Inc. d.b.a. AEMC® Instruments
15 Faraday Drive • Dover, NH 03820 USA
Phone: (800) 945-2362 (Ext. 360)
(603) 749-6434 (Ext. 360)
Fax: (603) 742-2346
E-mail: repair@aemc.com

Caution: To protect yourself against in-transit loss, we recommend you insure your returned material..



NOTE: You must obtain a CSA# before returning any instrument.

7. APPENDIX A

7.1 Measurements

7.1.1 Definition

Calculations are done according to IEC 61557-12 and IEC 61010-4-30.

Geometric representation of active and reactive power:

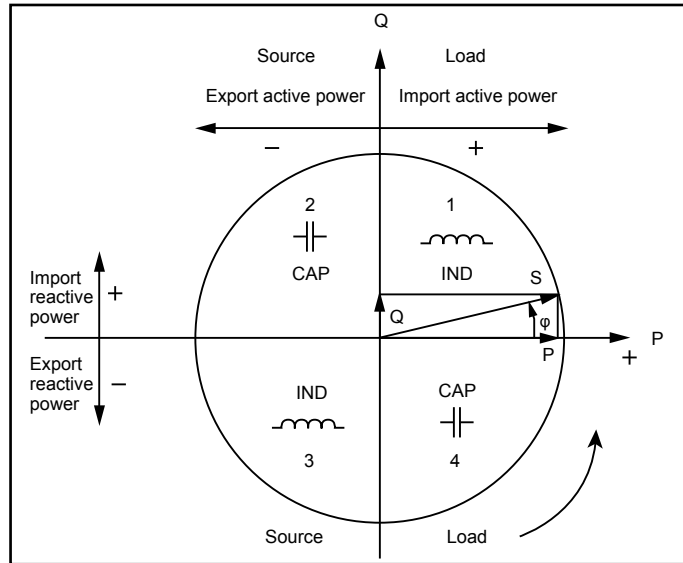

Figure 34

Diagram in accordance with clauses 12 and 14 of IEC 60375.

Reference of this diagram is the current vector (fixed on right-hand line).

The voltage vector V varies its direction according to the phase angle φ .

The phase angle φ between voltage V and current I is taken to be positive in the mathematical sense (counter-clockwise).

7.2 Sampling

7.2.1 Sampling Period

Depends on main frequency: 50 Hz, 60 Hz or 400 Hz

Sampling period is calculated every second

- Main frequency $f = 50$ Hz
 - Inside 42.5 Hz to 57.5 Hz ($50 \text{ Hz} \pm 15 \%$), sampling period is locked to main frequency. 128 samples are available for each main cycle.
 - Outside 42.5 Hz to 57.5 Hz, sampling period is 128×50 Hz.
- Main frequency $f = 60$ Hz
 - Inside 51 Hz to 69 Hz ($60 \text{ Hz} \pm 15 \%$), sampling period is locked to main frequency. 128 samples are available for each main cycle.
 - Outside 51 Hz to 69 Hz, sampling period is 128×60 Hz.
- Main frequency $f = 400$ Hz
 - Inside 340 Hz to 460 Hz ($400 \text{ Hz} \pm 15 \%$), sampling period is locked to main frequency. 16 samples are available for each main cycle.
 - Outside 340 Hz to 460 Hz, sampling period is 16×400 Hz.

DC is not a frequency parameter for sampling. A pure DC measured signal is considered to be outside the frequency ranges. Then, the sampling frequency is, according to the preselected main frequency, 6.4 kHz (50/400 Hz) or 7.68 kHz (60 Hz).

7.2.2 Locking of Sampling Frequency

- By default, sampling frequency is locked on V1
- If V1 is missing, sampling frequency tries to lock to V2, then V3, I1, I2 and I3

7.2.3 AC/DC

The PEL performs AC and DC measurements for alternative current and/or direct current distribution systems. Selection of AC or DC is done by the user.

AC +DC values are not available with PEL.



NOTE: AC+DC values could be calculated after download using the DataView® software.

7.2.4 Measurement of Neutral Current

For the PEL 102 and PEL 103, according to the distribution system, neutral current is calculated.

7.2.5 “1 second” Quantities

The instrument calculates the following quantities every second, according to § A.2.

“1 second” quantities are used for:

- Real time values
- “1 second” trends
- Aggregation of values for “aggregated” trends (see § A.1.2.6)
- Min and max determination for “aggregated” trends

All “1 second” quantities are saved on the SD-Card, during the recording time.

7.2.6 Aggregation

An aggregated quantity is a value calculated for a defined period, according to the formulas specified in Table 26. Aggregation periods always start on rounded hours/minutes. Aggregation period is the same for all quantities. The period is one of the following: (1, 2, 3, 4, 5, 6, 10, 12, 15, 20, 30 and 60) mn.

All aggregated quantities are saved on the SD-Card, during the recording session. They can be displayed in the PEL Control Panel (see § 4.2).

7.2.7 Max

Max represents the maximum values of the “1 second” quantities for the considered aggregation period. They are saved with the date and time of the Max (see Table 25 for the available values).

7.2.8 Energy Calculations

Energies are calculated every second.

The “Total” energy is the demand during the recording session.

The “Partial” energy can be determined during an integration period with the following values: 1 h, 1 day, 1 week, 1 month. The partial energy index is available only in real-time. It is not recorded.

However, the “Total” energy is available with the recording session data.

7.3 Measurement Formulas

PEL measures 128 samples per cycle (except 400 Hz with 16 samples) and calculates the voltage, current and active power quantities on a cycle.

PEL instruments measure or calculate the following quantities on a cycle (128 samples per cycle, except 400 Hz with 16 samples). Then the PEL calculates an aggregated value for 10 cycles (50 Hz), 12 cycles (60 Hz) or 80 cycles (400 Hz).

The 10/12 cycles quantities (50 Hz) are aggregated for 50/60 cycles (“1 second” quantities).

Quantities	Formula	Comments
AC RMS Line-to-neutral voltage (V_L)	$V_L [1s] = \sqrt{\frac{1}{N} \times \sum_1^N v_L^2}$	$v_L = v_1, v_2$ or v_3 elementary sample N = Number of samples
DC voltage (V_L)	$V_L [1s] = \frac{1}{N} \times \sum_1^N v_L$	L = v_1, v_2 or v_3 elementary sample N = Number of samples
AC RMS Line-to-line voltage (U_L)	$U_{ab} [1s] = \sqrt{\frac{1}{N} \times \sum_1^N u_{ab}^2}$	ab = u_{12}, u_{23} or u_{31} elementary sample N = Number of samples
AC RMS Current (I_L)	$I_L [1s] = \sqrt{\frac{1}{N} \times \sum_1^N i_L^2}$	$i_L = i_1, i_2$ or i_3 elementary sample N = Number of samples
DC Current (I_L)	$I_L [1s] = \frac{1}{N} \times \sum_1^N i_L$	$i_L = i_1, i_2$ or i_3 elementary sample N = Number of samples
Voltage crest factor (V-CF)	$V-CF [1s] = \frac{1}{5} \times \sum_1^5 CF_{VL}$	CF_{vL} is the ratio of average crest values and rms value of 10/12 periods
Current crest factor (I-CF)	$I-CF [1s] = \frac{1}{5} \times \sum_1^5 CF_{IL}$	CF_{iL} is the ratio of average crest values and rms value of 10/12 periods

Quantities	Formula	Comments
Unbalance (u_2) (real-time only)	$u_2[1s] = \sqrt{\frac{1 - \sqrt{3 - 6\beta}}{1 + \sqrt{3 - 6\beta}}}$ <p>with $\beta = \frac{U_{12fund}^4 + U_{23fund}^4 + U_{31fund}^4}{(U_{12fund}^2 + U_{23fund}^2 + U_{31fund}^2)^2}$</p>	
Active Power (P_L)	$P_L[1s] = \frac{1}{N} \times \sum_1^N (v_L \times i_L)$	L = 11, 12 or 13 elementary sample N = Number of samples $P_T[1s] = P_1[1s] + P_2[1s] + P_3[1s]$
Reactive Power (Q_L)	$Q_L[1s] = sign[1s] \times \sqrt{S_L^2[1s] - P_L^2[1s]}$	Reactive power includes harmonics. "sign[1s]" is the reactive power sign
	$Q_T[1s] = Q_1[1s] + Q_2[1s] + Q_3[1s]$	Total reactive power calculation $Q_r[1s]$ is vector.
Apparent Power (S_L)	$S_L[1s] = V_L[1s] \times I_L[1s]$	
	$S_T[1s] = S_1[1s] + S_2[1s] + S_3[1s]$	Total apparent power $S_r[1s]$ is an arithmetic value
Power Factor (PF_L)	$PF_L[1s] = \frac{P_L[1s]}{S_L[1s]}$	
Cos φ_L	$\cos(\varphi_L)[1s] = \frac{1}{5} \times \sum_1^5 \cos(\varphi_L)[10/12]$	Cos φ [10/12] is the cosinus of the difference between the phase of the fundamental of the current I and the phase of the fundamental of the line-to-neutral voltage V for 10/12 cycles values
TAN Φ	$tg(\varphi)[1s] = \frac{1}{5} \times \sum_1^5 \frac{Q[10/12]}{P[10/12]}$	Q[10/12] and P[10/12] are the 10/12 periods value for Q and P.
Line-to-neutral voltage harmonic distortion rate THD_VL (%)	$THD_V = 100 \times \sqrt{\frac{(V_{eff}^2 - V_m^2)}{V_m^2}}$	THD is calculated as % of fundamental VH1 is the value of fundamental
Line-to-line voltage harmonic distortion rate THD_Uab (%)	$THD_U = 100 \times \sqrt{\frac{(U_{eff}^2 - U_m^2)}{U_m^2}}$	THD is calculated as % of fundamental UH1 is the value of fundamental
Current harmonic distortion rate THD_IL (%)	$THD_I = 100 \times \sqrt{\frac{(I_{eff}^2 - I_m^2)}{I_m^2}}$	THD is calculated as % of fundamental IH1 is the value of fundamental

Table 24

7.4 Aggregation

Aggregated quantities are calculated for a defined period according to the following formulas based on 50/60 cycles. Aggregation can be averaging or quadratic averaging, or other methods.

Quantities	Formula
Line-to-neutral voltage (V_L) (RMS)	$V_{L[agg]} = \sqrt{\frac{1}{N} \times \sum_{x=0}^{N-1} V_{Lx}^2[1s]}$
Line-to-neutral voltage (V_L) (DC)	$V_{L[agg]} = \frac{1}{N} \times \sum_{x=0}^{N-1} V_{Lx}[200ms]$
Line-to-line voltage (U_{ab}) (RMS)	$U_{ab[agg]} = \sqrt{\frac{1}{N} \times \sum_{x=0}^{N-1} U_{abx}^2[1s]}$ ab = 12, 23 or 31
Current (I_L) (RMS)	$I_{L[agg]} = \sqrt{\frac{1}{N} \times \sum_{x=0}^{N-1} I_{Lx}^2[1s]}$
Current (I_L) (DC)	$I_{L[agg]} = \frac{1}{N} \times \sum_{x=0}^{N-1} I_{Lx}[200ms]$
Voltage crest factor (CF_{VL})	$CF_{VL[agg]} = \frac{1}{N} \times \sum_{x=0}^{N-1} CF_{VLx}[1s]$
Current crest factor (CF_{IL})	$CF_{IL[agg]} = \frac{1}{N} \times \sum_{x=0}^{N-1} CF_{ILx}[1s]$
Frequency (F)	$F[agg] = \frac{1}{N} \times \sum_{x=0}^{N-1} F_x[1s]$
Active Power on source (P_L)	$P_{SL[agg]} = \frac{1}{N} \times \sum_{x=0}^{N-1} P_{SLx}[1s]$
Active Power on load (P_L)	$P_{SL[agg]} = \frac{1}{N} \times \sum_{x=0}^{N-1} P_{SLx}[1s]$
Reactive Power on source (Q_L)	$Q_{SL[agg]} = \frac{1}{N} \times \sum_{x=0}^{N-1} Q_{SLx}[1s]$
Reactive Power on load (Q_L)	$Q_{RL[agg]} = \frac{1}{N} \times \sum_{x=0}^{N-1} Q_{RLx}[1s]$
Apparent Power (S_L)	$S_{L[agg]} = \frac{1}{N} \times \sum_{x=0}^{N-1} S_{Lx}[1s]$
Power Factor on source (PF _L) with associated quadrant	$PF_{SL[agg]} = \frac{1}{N} \times \sum_{x=0}^{N-1} PF_{SLx}[1s]$
Active Power on load (P_L)	$P_{SL[agg]} = \frac{1}{N} \times \sum_{x=0}^{N-1} P_{SLx}[1s]$
Reactive Power on source (Q_L)	$Q_{SL[agg]} = \frac{1}{N} \times \sum_{x=0}^{N-1} Q_{SLx}[1s]$
Reactive Power on load (Q_L)	$Q_{RL[agg]} = \frac{1}{N} \times \sum_{x=0}^{N-1} Q_{RLx}[1s]$
Apparent Power (S_L)	$S_{L[agg]} = \frac{1}{N} \times \sum_{x=0}^{N-1} S_{Lx}[1s]$

Quantities	Formula
Power Factor on source (PF _L) with associated quadrant	$PF_{SL}[agg] = \frac{1}{N} \times \sum_{x=0}^{N-1} PF_{SLx}[1s]$
Power Factor on load (PF _{LL}) with associated quadrant	$PF_{RL}[agg] = \frac{1}{N} \times \sum_{x=0}^{N-1} PF_{RLx}[1s]$
Cos φ _L on source with associated quadrant	$\text{Cos}(\varphi_L)_S[agg] = \frac{1}{N} \times \sum_{x=0}^{N-1} \text{Cos}(\varphi_L)_{Sx}[1s]$
Cos φ _L on load with associated quadrant	$\text{Cos}(\varphi_L)_R[agg] = \frac{1}{N} \times \sum_{x=0}^{N-1} \text{Cos}(\varphi_L)_{Rx}[1s]$
Tan Φ _S on source	$\text{Tan}(\varphi)_S[agg] = \frac{1}{N} \times \sum_{x=0}^{N-1} \text{Tan}(\varphi)_{Sx}[1s]$
Tan Φ _L on load	$\text{Tan}(\varphi)_R[agg] = \frac{1}{N} \times \sum_{x=0}^{N-1} \text{Tan}(\varphi)_{Rx}[1s]$
Line-to-neutral voltage harmonic distortion rate THD _{V_L} (%)	$THD_{V_L}[agg] = \frac{1}{N} \times \sum_{x=0}^{N-1} THD_{V_{Lx}}[1s]$
Line-to-line voltage harmonic distortion rate THD _{U_{ab}} (%)	$THD_{U_{ab}}[agg] = \frac{1}{N} \times \sum_{x=0}^{N-1} THD_{U_{abx}}[1s]$
Current harmonic distortion rate THD _{I_L} (%)	$THD_{I_L}[agg] = \frac{1}{N} \times \sum_{x=0}^{N-1} THD_{I_{Lx}}[1s]$

Table 25

NOTE: N is the number of “1 second” values for the considered aggregation period (1, 2, 3, 4, 5, 6, 10, 12, 15, 20, 30 or 60 min).

7.5 Supported Electrical Networks

The following types of distribution systems are supported:



- V1, V2, V3 are the line-to-neutral voltages of the installation under test
- [V1=VL1-N; V2=VL2-N; V3=VL3-N].
- Low caps v1, v2, v3 are used for time values
- U12, U23, U31 are the line-to-line voltages of the installation under test.
- Low caps are used for time values [u12 = v1-v2; u23= v2-v3, u31=v3-v1]
- I1, I2, I3 are the currents flowing in the line conductors of the installation under test.
- Low caps i1, i2, i3 are used for time values

Distribution System	Abbreviation	Comments	Reference Diagram
Single phase (1-Phase 2-Wire)	1P-2W	Voltage measurements are performed between L1 and N. Current measurements are performed on L1 conductor.	see § 3.6.1
Split phase (1-Phase 3-Wire)	1P-3W	Voltage measurements are performed between L1, L2 and N. Current measurements are performed on L1 and L2 conductors. Neutral current is calculated: $i_N = i_1 + i_2$	see § 3.6.2
3-Phase 3-Wire Δ [2 current sensors]	3P-3W Δ 2	Power measurement method is based on 3 wattmeters method with virtual neutral.	see § 3.6.3.1
3-Phase 3-Wire Open- Δ [2 current sensors]	3P-3WO2	Voltage measurements are performed between L1, L2 and L3. Current measurements are performed on L1 and L3 conductors.	see § 3.6.3.3
3-Phase 3-Wire Y [2 current sensors]	3P-3WY2	I2 current is calculated (no current sensor connected on L2): $i_2 = -i_1 - i_3$ Neutral is not available for current and voltage measurement	see § 3.6.3.5
3-Phase 3-Wire Δ	3P-3W Δ 3	Power measurement method is based on 3 wattmeters method with virtual neutral.	see § 3.6.3.2
3-Phase 3-Wire Open- Δ	3P-3WO3	Voltage measurements are performed between L1, L2 and L3.	see § 3.6.3.4
3-Phase 3-Wire Y	3P-3WY3	Current measurements are performed on L1, L2 and L3 conductors. Neutral is not available for current and voltage measurement	see § 3.6.3.6
3-Phase 3-Wire Δ balanced	3P-3W Δ B	Power measurement is based on 1 wattmeter method. Voltage measurements are performed between L1 and L2. Current measurements are performed on L3 conductor. $U_{23} = U_{31} = U_{12}$. $I_1 = I_2 = I_3$	see § 3.6.3.7
3-Phase 4-Wire Y	3P-4WY	Power measurement method is based on 3 wattmeters method with neutral. Voltage measurements are performed between L1, L2 and L3. Current measurements are performed on L1, L2 and L3 conductors. Neutral current is calculated: $i_N = i_1 + i_2 + i_3$.	see § 3.6.4.1

3-Phase 4-Wire Y balanced	3P-4WYB	<p>Power measurement is based on single phase wattmeter method.</p> <p>Voltage measurements are performed between L1 and N.</p> <p>Current measurements are performed on L1 conductor.</p> <p>$V1 = V2 = V3$</p> <p>$U23 = U31 = U12 = V1 \times \sqrt{3}$.</p> <p>$I1 = I2 = I3$</p>	see § 3.6.4.2
3-Phase 4-Wire Y 2½	3P-4WY2	<p>This method is named 2½ element method.</p> <p>Power measurement method is based on 3 wattmeters method with virtual neutral.</p> <p>Voltage measurements are performed between L1, L3 and N.</p> <p>V2 is calculated: $v2 = -v1 - v3$, $u12 = 2 \cdot v1 + v3$, $u23 = -v1 - 2 \cdot v3$. It supposes that V2 is balanced.</p> <p>Current measurements are performed on L1, L2 and L3 conductors.</p> <p>Neutral current is calculated: $iN = i1 + i2 + i3$</p>	see § 3.6.4.3
3-Phase 4-Wire Δ	3P-4WΔ	<p>Power measurement method is based on 3 wattmeters method with neutral, but no power information for each phase is available.</p>	see § 3.6.5.1
3-Phase 4-Wire Open-Δ	3P-4WOΔ	<p>Voltage measurements are performed between L1, L2 and L3.</p> <p>Current measurements are performed on L1, L2 and L3 conductors.</p> <p>Neutral current is calculated only for a transformer branch: $iN = i1 + i2$</p>	see § 3.6.5.2
DC 2-Wire	DC-2W	<p>Voltage measurements are performed between L1 and N.</p> <p>Current measurements are performed on L1 conductor.</p>	see § 3.6.6.1
DC 3-Wire	DC-3W	<p>Voltage measurements are performed between L1, L2 and N.</p> <p>Current measurements are performed on L1 and L2 conductors.</p> <p>Negative (return) current is calculated : $iN = i1 + i2$</p>	see § 3.6.6.2
DC 4-Wire	DC-4W	<p>Voltage measurements are performed between L1, L2, L3 and N.</p> <p>Current measurements are performed on L1, L2 and L3 conductors.</p> <p>Negative (return) current is calculated : $iN = i1 + i2 + i3$</p>	see § 3.6.6.3

Table 26

7.6 Phase Order

Every second, the PEL determines the phase order. If the phase order is incorrect, the red Phase Order indicator  on the PEL front panel blinks (see § 2.11). In addition, on the PEL 103, the Phase Order Incorrect icon  appears on the LCD Display screen.

Setting the correct phase order for a distribution system requires that the current phase order, voltage phase order, and current vs voltage phase order for that distribution system are all correct. Note that:

- Phase order for voltage channels only is displayed when voltages are displayed on the LCD screen. The voltage phase order is derived from the FFT analysis.
- Phase order for current channels only is displayed when currents are displayed.
- Phase order for voltage and current channels is displayed when the other screens are displayed.
- Load or Source is set by the DataView PEL Control Panel.

In some distribution systems (such as DC) the phase order does not apply in every instance.

The following three tables show information for each distribution system for setting the correct current phase order, voltage phase order, and current vs voltage phase order respectively.

7.7 Current Phase Order

Distribution System	Abbreviation	Current Phase Order	Comments
Single phase (1-Phase 2-Wire)	1P-2W	No	
Split phase (1-Phase 3-Wire)	1P-3W	Yes	$\phi (I2, I1) = 180^\circ \pm 30^\circ$
3-Phase 3-Wire Δ [2 current sensors]	3P-3W Δ 2	Yes	$\phi (I1, I3) = 120^\circ \pm 30^\circ$ No I2 current sensors
3-Phase 3-Wire Open- Δ [2 current sensors]	3P-3WO2		
3-Phase 3-Wire Y [2 current sensors]	3P-3WY2		
3-Phase 3-Wire Δ	3P-3W Δ 3	Yes	$[\phi (I1, I3), \phi (I3, I2), \phi (I2, I1)] = 120^\circ \pm 30^\circ$
3-Phase 3-Wire Open- Δ	3P-3WO3		
3-Phase 3-Wire Y	3P-3WY3		
3-Phase 3-Wire Δ balanced	3P-3W Δ B	No	
3-Phase 4-Wire Y	3P-4WY	Yes	$[\phi (I1, I3), \phi (I3, I2), \phi (I2, I1)] = 120^\circ \pm 30^\circ$
3-Phase 4-Wire Y balanced	3P-4WYB	No	
3-Phase 4-Wire Y 2½	3P-4WY2	Yes	$[\phi (I1, I3), \phi (I3, I2), \phi (I2, I1)] = 120^\circ \pm 30^\circ$
3-Phase 4-Wire Δ	3P-4W Δ	Yes	$[\phi (I1, I3), \phi (I3, I2), \phi (I2, I1)] = 120^\circ \pm 30^\circ$
3-Phase 4-Wire Open- Δ	3P-4WO Δ		
DC 2-Wire	DC-2W	No	
DC 3-Wire	DC-3W	No	
DC 4-Wire	DC-4W	No	

7.8 Voltage Phase Order

Distribution System	Abbreviation	Current Phase Order	Comments
Single phase (1-Phase 2-Wire)	1P-2W	No	
Split phase (1-Phase 3-Wire)	1P -3W	Yes	$\phi (V2, V1) = 180^\circ \pm 10^\circ$
3-Phase 3-Wire Δ [2 current sensors]	3P-3W Δ 2	Yes (on U)	$[\phi (U12, U31), \phi (U31, U23), \phi (U23, U12)] = 120^\circ \pm 10^\circ$
3-Phase 3-Wire Open- Δ [2 current sensors]	3P-3WO2		
3-Phase 3-Wire Y [2 current sensors]	3P-3WY2		
3-Phase 3-Wire Δ	3P-3W Δ 3		
3-Phase 3-Wire Open- Δ	3P-3WO3		
3-Phase 3-Wire Y	3P-3WY3		
3-Phase 3-Wire Δ balanced	3P-3W Δ B	No	
3-Phase 4-Wire Y	3P-4WY	Yes (on V)	$[\phi (V1, V3), \phi (V3, V2), \phi (V2, V1)] = 120^\circ \pm 10^\circ$
3-Phase 4-Wire Y balanced	3P-4WYB	No	
3-Phase 4-Wire Y 2½	3P-4WY2	Yes (on V)	$\phi (V1, V3) = 120^\circ \pm 10^\circ$ No V2
3-Phase 4-Wire Δ	3P-4W Δ	Yes (on U)	$\phi (V1, V3) = 180^\circ \pm 10^\circ$ $[\phi (U12, U31), \phi (U31, U23), \phi (U23, U12)] = 120^\circ \pm 10^\circ$
3-Phase 4-Wire Open- Δ	3P-4WO Δ		
DC 2-Wire	DC-2W	No	
DC 3-Wire	DC-3W	No	
DC 4-Wire	DC-4W	No	

7.9 Current vs Voltage Phase Order

Distribution System	Abbreviation	Current Phase Order	Comments
Single phase (1-Phase 2-Wire)	1P-2W	Yes	$\phi (I1, V1) = 0^\circ \pm 60^\circ$ for load $\phi (I1, V1) = 180^\circ \pm 60^\circ$ for source
Split phase (1-Phase 3-Wire)	1P -3W	Yes	$[\phi (I1, V1), \phi (I2, V2)] = 0^\circ \pm 60^\circ$ for load $[\phi (I1, V1), \phi (I2, V2)] = 180^\circ \pm 60^\circ$ for source
3-Phase 3-Wire Δ [2 current sensors]	3P-3W Δ 2	Yes	$[\phi (I1, U12), \phi (I3, U31)] = 30^\circ \pm 60^\circ$ for load $[\phi (I1, U12), \phi (I3, U31)] = 210^\circ \pm 60^\circ$ for source No I2 current sensor
3-Phase 3-Wire Open- Δ [2 current sensors]	3P-3WO2		
3-Phase 3-Wire Y [2 current sensors]	3P-3WY2		
3-Phase 3-Wire Δ	3P-3W Δ 3	Yes	$[\phi (I1, U12), \phi (I2, U23), \phi (I3, U31)] = 30^\circ \pm 60^\circ$ for load $[\phi (I1, U12), \phi (I2, U23), \phi (I3, U31)] = 210^\circ \pm 60^\circ$ for source
3-Phase 3-Wire Open- Δ	3P-3WO3		
3-Phase 3-Wire Y	3P-3WY3		
3-Phase 3-Wire Δ balanced	3P-3W Δ B	Yes	$\phi (I3, U12) = 90^\circ \pm 60^\circ$ for load $\phi (I3, U12) = 270^\circ \pm 60^\circ$ for source
3-Phase 4-Wire Y	3P-4WY	Yes	$[\phi (I1, V1), \phi (I2, V2), \phi (I3, V3)] = 0^\circ \pm 60^\circ$ for load $[\phi (I1, V1), \phi (I2, V2), \phi (I3, V3)] = 180^\circ \pm 60^\circ$ for source
3-Phase 4-Wire Y balanced	3P-4WYB	Yes	$\phi (I1, V1) = 0^\circ \pm 60^\circ$ for load $\phi (I1, V1) = 180^\circ \pm 60^\circ$ for source
3-Phase 4-Wire Y 2½	3P-4WY2	Yes	$[\phi (I1, V1), \phi (I3, V3)] = 0^\circ \pm 60^\circ$ for load $[\phi (I1, V1), \phi (I3, V3)] = 180^\circ \pm 60^\circ$ for source No V2
3-Phase 4-Wire Δ	3P-4W Δ	Yes	$[\phi (I1, U12), \phi (I2, U23), \phi (I3, U31)] = 30^\circ \pm 60^\circ$ for load $[\phi (I1, U12), \phi (I2, U23), \phi (I3, U31)] = 210^\circ \pm 60^\circ$ for source
3-Phase 4-Wire Open- Δ	3P-4WO Δ		
DC 2-Wire	DC-2W	No	
DC 3-Wire	DC-3W	No	
DC 4-Wire	DC-4W	No	

7.10 Quantities According to the Supply Systems

● = YES

Quantities		1P-2W	1P-3W	3P-3W Δ 2 3P-3WO2 3P-3WY2	3P-3W Δ 3 3P-3WO3 3P-3WY3	3P-3W Δ B	3P-4WY	3P-4WYB	3P-4WY2	3P-4W Δ 3P-4WO Δ	DC-2W	DC-3W	DC-4W
V ₁	RMS	●	●				●	●	●	●			
V ₂	RMS		●				●	●(1)	●(1)	●			
V ₃	RMS						●	●(1)	●	●			
V ₁	DC										●	●	●
V ₂	DC											●	●
V ₃	DC												●
U ₁₂	RMS		●	●	●	●	●	●(1)	●(1)	●			
U ₂₃	RMS			●	●	●(1)	●	●(1)	●(1)	●			
U ₃₁	RMS			●	●	●(1)	●	●(1)	●	●			
I ₁	RMS	●	●	●	●	●	●	●	●	●			
I ₂	RMS		●	●(2)	●	●(1)	●	●(1)	●	●			
I ₃	RMS			●	●	●(1)	●	●(1)	●	●			
I _N	RMS		●(5)				●(5)	●(1)	●(5)	●(5)			
I ₁	DC										●	●	●
I ₂	DC											●	●
I ₃	DC												●
I _N	DC											●(5)	●(5)
V _{1CF}		●	●				●	●	●	●			
V _{2CF}			●				●	●(1)	●	●			
V _{3CF}							●	●(1)	●	●			
I _{1CF}		●	●	●	●	●	●	●	●	●			
I _{2CF}			●	●(2)	●	●(1)	●	●(1)	●	●			
I _{3CF}				●	●	●	●	●(1)	●	●			
u ₂				●	●	●(4)	●	●(4)	●(4)	●(3)			
F		●	●	●	●	●	●	●	●	●			
P ₁		●	●				●	●	●	●	●	●	●
P ₂			●				●	●(1)	●(1)	●(3)		●	●
P ₃							●	●(1)	●	●			●
P _T			●	●	●	●	●	●(1)	●	●		●	●
P ₁	Source	●	●				●	●	●	●	●	●	●
P ₂	Source		●				●	●(1)	●(1)	●(3)		●	●
P ₃	Source						●	●(1)	●	●			●
P _T	Source		●	●	●	●	●	●(1)	●	●		●	●
P ₁	Load	●	●				●	●	●	●	●	●	●
P ₂	Load		●				●	●(1)	●(1)	●(3)		●	●
P ₃	Load						●	●(1)	●	●			●
P _T	Load		●	●	●	●	●	●(1)	●	●		●	●
Q ₁		●	●				●	●	●	●			
Q ₂			●				●	●(1)	●(1)	●(3)			
Q ₃							●	●(1)	●	●			
Q _T			●	●	●	●	●	●(1)	●	●			
Q ₁	Source	●	●				●	●	●	●			
Q ₂	Source		●				●	●(1)	●(1)	●(3)			
Q ₃	Source						●	●(1)	●	●			

Quantities		1P-2W	1P-3W	3P-3W Δ 2 3P-3WO2 3P-3WY2	3P-3W Δ 3 3P-3WO3 3P-3WY3	3P-3W Δ B	3P-4WY	3P-4WYB	3P-4WY2	3P-4W Δ 3P-4WO Δ	DC-2W	DC-3W	DC-4W	
Q _T	Source		●	●	●	●	●	●(1)	●	●				
Q ₁	Load	●	●				●	●	●	●				
Q ₂	Load		●				●	●(1)	●(1)	●(3)				
Q ₃	Load						●	●(1)	●	●				
Q _T	Load		●	●	●	●	●	●(1)	●	●				
S ₁		●	●				●	●	●	●				
S ₂			●				●	●(1)	●(1)	●(3)				
S ₃							●	●(1)	●	●				
S _T			●	●	●	●	●	●(1)	●	●				
PF ₁		●	●				●	●	●	●				
PF ₂			●				●	●(1)	●(1)	●(3)				
PF ₃							●	●(1)	●	●				
PF _T			●	●	●	●	●	●(1)	●	●				
PF ₁	Source	●	●				●	●	●	●				
PF ₂	Source		●				●	●(1)	●(1)	●(3)				
PF ₃	Source						●	●(1)	●	●				
PF _T	Source		●	●	●	●	●	●(1)	●	●				
PF ₁	Load	●	●				●	●	●	●				
PF ₂	Load		●				●	●(1)	●(1)	●(3)				
PF ₃	Load						●	●(1)	●	●				
PF _T	Load		●	●	●	●	●	●(1)	●	●				
Cos φ_1		●	●				●	●	●	●				
Cos φ_2			●				●	●(1)	●(1)	●(3)				
Cos φ_3							●	●(1)	●	●				
Cos φ_T			●	●	●	●	●	●(1)	●	●				
Cos φ_1	Source	●	●				●	●	●	●				
Cos φ_2	Source		●				●	●(1)	●(1)	●(3)				
Cos φ_3	Source						●	●(1)	●	●				
Cos φ_M	Source		●	●	●	●	●	●(1)	●	●				
Cos φ_1	Load	●	●				●	●	●	●				
Cos φ_2	Load		●				●	●(1)	●(1)	●(3)				
Cos φ_3	Load						●	●(1)	●	●				
Cos φ_T	Load		●	●	●	●(3)	●	●(1)	●	●				
TAN Φ		●	●	●	●	●(3)	●	●	●(1)	●(3)				
TAN Φ	Source	●	●	●	●	●(3)	●	●	●	●				
TAN Φ	Load	●	●	●	●	●(3)	●	●	●	●				
Hi_V ₁	i=1 to 50(6)	●	●				●	●	●	●				
Hi_V ₂			●				●	●(1)	●	●(3)				
Hi_V ₃								●	●(1)	●	●			
Hi_U ₁₂	i=1 to 50(6)		●	●	●	●	●	●(1)	●(1)	●				
Hi_U ₂₃				●	●	●(1)	●	●(1)	●(1)	●				
Hi_U ₃₁					●	●	●(1)	●	●(1)	●	●			
Hi_I ₁	i=1 to 50(6)	●	●	●	●	●	●	●	●	●				
Hi_I ₂				●(2)	●	●(1)	●	●(1)	●	●				
Hi_I ₃					●	●	●(1)	●	●(1)	●	●			
Hi_I _N				●(2)				●(2)	●(1)	●(2)	●(2)			
THD_V ₁		●	●				●	●	●	●				

Quantities		1P-2W	1P-3W	3P-3W Δ 2 3P-3WO2 3P-3WY2	3P-3W Δ 3 3P-3WO3 3P-3WY3	3P-3W Δ B	3P-4WY	3P-4WYB	3P-4WY2	3P-4W Δ 3P-4WO Δ	DC-2W	DC-3W	DC-4W
THD_V ₂			●				●	●(1)	●	●(3)			
THD_V ₃							●	●(1)	●	●			
THD_U ₁₂			●	●	●	●	●	●(1)	●(1)	●			
THD_U ₂₃				●	●	●(1)	●	●(1)	●(1)	●			
THD_U ₂₃				●	●	●(1)	●	●(1)	●	●			
THD_I ₁		●	●	●	●	●	●	●	●	●			
THD_I ₂			●	●(2)	●	●(1)	●	●(1)	●	●			
THD_I ₃				●	●	●(1)	●	●(1)	●	●			
THD_I _N			●(2)				●(2)	●(1)	●(2)	●(2)			
V ₁ Angle		●	●				●	●	●	●			
V ₂ Angle			●				●	●(1)	●(1)	●(3)			
V ₃ Angle							●	●(1)	●	●			
U ₁₂ Angle			●	●	●	●	●	●(1)	●(1)	●			
U ₂₃ Angle				●	●	●(1)	●	●(1)	●(1)	●			
U ₃₁ Angle				●	●	●(1)	●	●(1)	●	●			
I ₁ Angle		●	●	●	●	●	●	●	●	●			
I ₂ Angle			●	●(2)	●	●(1)	●	●(1)	●	●			
I ₃ Angle				●	●	●(1)	●	●(1)	●	●			

Table 27

- (1) Extrapolated
- (2) Calculated
- (3) Not a significant value
- (4) Always = 0
- (5) Calculated
- (6) Rank 7 for 400Hz

7.11 Glossary of Terms

Symbol or Terminology	Description
\approx	AC and DC components.
\sim	AC component only.
\equiv	DC component only.
$\overset{+}{\sim}$	Inductive phase shift.
$\overset{-}{\sim}$	Capacitive phase shift.
°	Degree.
%	Percentage.
CF	Crest factor (Peak Factor) in current or voltage: ratio of the peak value of a signal to the RMS value.
Cos ϕ	Cosine of the phase shift of the fundamental voltage with respect to the fundamental current.
DC	DC component (current or voltage)
Ep	Abbreviation for active energy.
Eq	Abbreviation for reactive energy.
Es	Abbreviation for apparent energy.
Frequency	Number of full voltage or current cycles in one second.
Fundamental Component	Component at the fundamental frequency.
Harmonics	In electrical systems, voltages and currents at frequencies that are multiples of the fundamental frequency.
Hz	Frequency of network studied.
I	Abbreviation for current.
I-CF	Crest (peak) factor of current.
I-THD	Total harmonic distortion of current.
I_x-H_n	Current value or percentage for harmonic rank n.
L	Phase (Line).
MAX	Maximum value
Measurement Method	All measurement methods associated to an individual measurement.
MIN	Minimum value
Nominal Voltage	Reference voltage of a network.
P	Abbreviation for active power.
PF	Power Factor: ratio of active power to apparent power.
Phase	Temporal relationship between current and voltage in alternating current circuits.
Q	Abbreviation for reactive power.
Rank of a Harmonic	Ratio of the frequency of the harmonic to the fundamental frequency; a whole number.
RMS	RMS (Root Mean Square) value of current or voltage. Square root of the mean of the squares of the instantaneous values of a quantity during a specified interval.
S	Abbreviation for apparent power.
Tan ϕ	Ratio between reactive power and active power.
THD	Total Harmonic Distortion. The total harmonic distortion describes the proportion of the harmonics of a signal with respect to the fundamental RMS value (%f).
U	Phase-to-phase voltage
U-CF	Phase-to-phase voltage crest factor
U_n	Phase-to-phase voltage harmonic
Unbalance in voltage in a polyphased electrical power network	Status where efficient values for voltages between conductors (fundamental component) and/or differences in phase between successive conductors are not equal.
U_x-H_n	Phase-to-phase voltage value or percentage for harmonic rank n.
U_{xy}-THD	Total phase-to-phase voltage harmonic distortion.
V	Abbreviation for phase-to-neutral voltage or the unit "volt".

Symbol or Terminology	Description
V-CF	Voltage crest (peak) factor.
VA	Apparent power unit (Volt - Ampere).
var	Reactive power unit.
varh	Reactive energy unit.
V-THD	Voltage crest (peak) factor.
Vh	Phase-to-neutral voltage harmonic.
V	True RMS phase-to-neutral voltage.
V-THD	Total harmonic distortion of phase-to-neutral voltage.
Vunb	Phase-to-neutral voltage unbalance.
Vx-Hn	Phase-to-neutral voltage value or percentage for harmonic rank n.
W	Active power unit (Watt).
Wh	Active energy unit (Watt - hour).

Table 28

Prefixes of International System (SI) units

Prefix	Symbol	Multiplies by
milli	m	10^{-3}
kilo	k	10^3
Mega	M	10^6
Giga	G	10^9
Tera	T	10^{12}
Peta	P	10^{15}
Exa	E	10^{18}

Table 29