

FLUKE®

— Calibration

2700G Series

Reference Pressure Gauge

Users Manual

September 2012

© 2012 Fluke Corporation. All rights reserved. Specifications are subject to change without notice.
All product names are trademarks of their respective companies.

LIMITED WARRANTY AND LIMITATION OF LIABILITY

Each Fluke product is warranted to be free from defects in material and workmanship under normal use and service. The warranty period is one year and begins on the date of shipment. Parts, product repairs, and services are warranted for 90 days. This warranty extends only to the original buyer or end-user customer of a Fluke authorized reseller, and does not apply to fuses, disposable batteries, or to any product which, in Fluke's opinion, has been misused, altered, neglected, contaminated, or damaged by accident or abnormal conditions of operation or handling. Fluke warrants that software will operate substantially in accordance with its functional specifications for 90 days and that it has been properly recorded on non-defective media. Fluke does not warrant that software will be error free or operate without interruption. Fluke authorized resellers shall extend this warranty on new and unused products to end-user customers only but have no authority to extend a greater or different warranty on behalf of Fluke. Warranty support is available only if product is purchased through a Fluke authorized sales outlet or Buyer has paid the applicable international price. Fluke reserves the right to invoice Buyer for importation costs of repair/replacement parts when product purchased in one country is submitted for repair in another country. Fluke's warranty obligation is limited, at Fluke's option, to refund of the purchase price, free of charge repair, or replacement of a defective product which is returned to a Fluke authorized service center within the warranty period.

Fluke assumes no risk for damage in transit. Following warranty repair, the product will be returned to Buyer, transportation prepaid (FOB Destination). If Fluke determines that failure was caused by neglect, misuse, contamination, alteration, accident, or abnormal condition of operation or handling, including overvoltage failures caused by use outside the product's specified rating, or normal wear and tear of mechanical components, Fluke will provide an estimate of repair costs and obtain authorization before commencing the work. Following repair, the product will be returned to the Buyer transportation prepaid and the Buyer will be billed for the repair and return transportation charges (FOB Shipping Point).

THIS WARRANTY IS BUYER'S SOLE AND EXCLUSIVE REMEDY AND IS IN LIEU OF ALL OTHER WARRANTIES, EXPRESS OR IMPLIED, INCLUDING BUT NOT LIMITED TO ANY IMPLIED WARRANTY OF MERCHANTABILITY OR FITNESS FOR A PARTICULAR PURPOSE. FLUKE SHALL NOT BE LIABLE FOR ANY SPECIAL, INDIRECT, INCIDENTAL, OR CONSEQUENTIAL DAMAGES OR LOSSES, INCLUDING LOSS OF DATA, ARISING FROM ANY CAUSE OR THEORY.

Since some countries or states do not allow limitation of the term of an implied warranty, or exclusion or limitation of incidental or consequential damages, the limitations and exclusions of this warranty may not apply to every buyer. If any provision of this Warranty is held invalid or unenforceable by a court or other decision-maker of competent jurisdiction, such holding will not affect the validity or enforceability of any other provision.

11/99

Table of Contents

Title	Page
Introduction	1
How to Contact Fluke Calibration	1
Standard Equipment.....	2
Safety Information	2
Special Conditions for Safe Use	3
Symbols.....	4
Display and Buttons	5
Operation	6
How to Setup the Product.....	6
Engineering Units	6
Set Auto Off	7
Show Battery Voltage	7
Display Actual Temperature	7
Set Damping	7

2700G Series
Users Manual

Set Sample Rate	7
Set Tare	7
Function Lock	8
Supervisory Mode	8
Available Pressure Ranges	8
How to Set a Custom Engineering Unit or Scale	9
Battery Life	9
Maintenance	9
How to Clean the Product	9
How to Change the Batteries	10
Accessories	11
USB Interface Cable	11
Power Module	11
Serial Interface Instructions	13
Initiating Communication	13
List of Commands	13
Parameter Units	14
Error Codes	15
Units Conversion	16
Specifications	18
Accuracy	18
Media Compatibility	18
Environmental	18
Mechanical Specifications	19
Available Pressure Ranges	20

List of Tables

Table	Title	Page
1.	Symbols.....	4
2.	Display and Buttons	5
3.	Units Conversion.....	16

List of Figures

Figure	Title	Page
1.	The Product.....	5
2.	Change the Batteries.....	10
3.	USB Power Module and Universal Connectors	12

Introduction

The 2700G Series Reference Pressure Gauges (the Product) are high-accuracy digital pressure test gauges. Accurate to 0.02 % FS, the Product can be used as a calibration reference, or in applications where high-accuracy pressure measurement is required.

The Product features user-configurable functions that include:

- Sampling rate
- Tare
- Damping
- Auto off
- Min Max

When the Product is configured, you can lock its settings and use password protection to prevent configuration changes. See the “Supervisory Mode” section.

Standard Equipment

The Product ships with:

- Protective Cover (installed)
- Three AA Alkaline Batteries (installed)
- Safety Information (printed)
- Report of Calibration
- Manuals CD-ROM with translated Users Manuals
- USB Cable
- USB Power Adapter
- NPT to ¼ BSP Male Adapter
- NPT to M20 x 1.5 Male Adapter

Safety Information

A **Warning** identifies conditions and procedures that are dangerous to the user. A **Caution** identifies conditions and procedures that can cause damage to the Product or the equipment under test.

⚠⚠ Warning

To prevent injury, only assemble and operate high-pressure systems if you know the correct safety procedures. High-pressure liquids and gases are hazardous and the energy from them can be released without warning.

To prevent possible electrical shock, fire, or personal injury:

- **Read all safety information before you use the Product.**
- **Use the Product only as specified, or the protection supplied by the Product can be compromised.**
- **Do not use the Product around explosive gas, vapor, or in damp or wet environments.**
- **Do not use and disable the Product if it is damaged.**
- **Remove the batteries if the Product is not used for an extended period of time, or if stored in temperatures above 50 °C. If the batteries are not removed, battery leakage can damage the Product.**

- Replace the batteries when the low battery indicator shows to prevent incorrect measurements.
- The battery door must be closed and locked before you operate the Product.

⚠ Caution

To prevent possible damage to Product or to equipment under test:

- The display reads “OL” when the pressure source is above the Product range limit. The pressure source must immediately be removed.
- Do not apply more than the maximum torque specified. Maximum torque specified is 20 Nm = 15 ft-lb.

Special Conditions for Safe Use

Misuse

If the Product is exposed to overpressure or sudden physical shock (such as being dropped) examine it for damage that can cause a safety issue. If necessary, send the Product for examination to Fluke. Refer to the How to Contact Fluke Calibration section.

⚠ Warning





To prevent possible fire, or personal injury:

- Do not use the Product with flammable substances.
- The Product is intended for installation only in locations with protection against the entry of solid unwanted objects or water that can compromise safety.

Symbols

Symbols used on the Product and in this manual are in Table 1.

Table 1. Symbols

Symbol	Meaning	Symbol	Meaning
	Risk of danger. Important information. See manual.	CE	Conforms to European Union directives.
	Hazardous voltage. Risk of electrical shock.		Conforms to relevant North American Safety Standards.
	Conforms to relevant Australian standards.		This product complies with the WEEE Directive (2002/96/EC) marking requirements. The affixed label indicates that you must not discard this electrical/electronic product in domestic household waste. Product Category: With reference to the equipment types in the WEEE Directive Annex I, this product is classed as category 9 "Monitoring and Control Instrumentation" product. Do not dispose of this product as unsorted municipal waste. Go to Fluke's website for recycling information.

Display and Buttons

The Display and Buttons are shown in Figure 1. The Buttons are in Table 2.

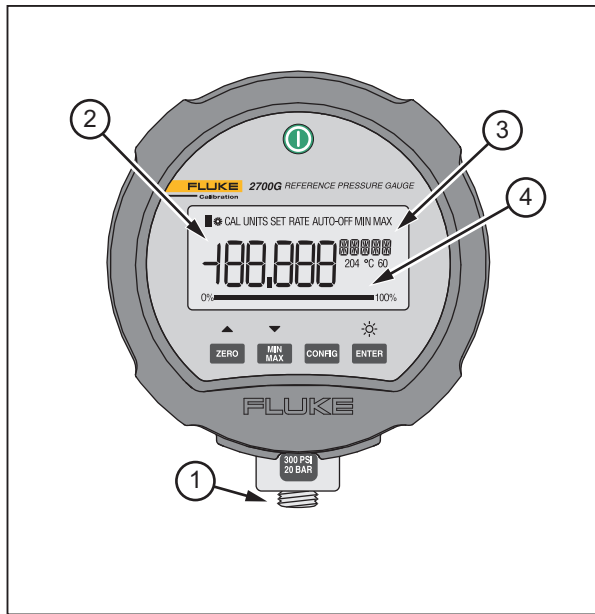



Figure 1. The Product

gsn001.eps

Table 2. Display and Buttons

Item	Function
	Push to turn on the Product. Push again to turn off the Product.
	Zeros the display. In Configure Mode, push the button to move forward through the menus.
	<p>MIN MAX records minimum and maximum pressure values and saves them to memory. Push to show maximum (MAX) indication. Push again to show minimum (MIN) indication. After 2 seconds, the gauge goes back to live operation.</p> <p>To clear the MIN MAX memory values, push and hold for 2 seconds until CLR is shown.</p> <p>In Configure Mode, push (▼) to move backward through the menus.</p>

Table 2. Display and Buttons (cont.)

Item	Function
	Push to go to setup and configuration menus.
	Push to make a selection. When the Product is not in Configuration mode, push to turn on the backlight. Push again to turn off the backlight.
①	NPT Connector
②	Pressure Display
③	Engineering Units
④	Bargraph

Operation

The subsequent sections tell you how to operate the Product. Push  to turn on the Product.





The analog bar graph at the bottom of the display shows the applied-pressure level relative to the full range of the gauge.

Note





If you record a Tare value, the pressure shown is not the actual pressure applied.

How to Setup the Product

Before you use the product, it is necessary to configure it for your application. Push  to go to the Setup menu.

Each time  is pushed, the display goes to the subsequent function. Push  or  to change the parameter value. When a parameter is set, push  to exit the configuration menu or  to move to the next parameter.

Engineering Units

The Product's default engineering unit shows psi. To change this, push  and  to move through the standard engineering units plus one custom unit/scale. When the necessary unit shows, push  or . Pressure now shows in the chosen engineering units. See the Specifications section for a list of available

engineering units. See the Supervisory Mode section for instructions to set up custom units.

Set Auto Off

Auto Off can be set in 1 minute increments from 1 to 30 minutes or you can turn off the function for continuous Product operation. The Product is configured for 30 minutes. Push ▲ and ▼ to set the necessary interval. The “off” position is at the low end of the selections, less than 1 minute.

Show Battery Voltage

Actual battery voltage and a percent-of-life bargraph show the battery charge. No adjustments are made in this parameter.

Display Actual Temperature

The Product is temperature compensated This parameter shows the temperature measured by the internal sensor. Push ▲ or ▼ to show degrees F or C.

Set Damping

Selections are “on” ▲ and “off” ▼. Damping smooths readings from pulsating pressure sources.

Set Sample Rate

This function finds how many times pressure is sampled and the display is updated. Selections are 0.5, 1, 3, and 10 samples/second. Note that 10/second gives the fastest response time.

Set Tare

Use this function to set a constant offset value that is then subtracted from the measured pressure. For example, if a tare is set at 30 psi, and the measured pressure is 37 psi, 7 psi is shown.

A pressure of 27 psi is shown as -3 psi.

Push ▲ and ▼ to set the tare value. The value is in relation to the engineering units and resolution selected for display. Tare value can be set to the maximum range of the gauge.

For safety, the bar graph always shows the actual pressure in relation to the full range of the gauge regardless of the tare position. This is done to make sure that with a “0” reading pressure is being applied to the gauge.

Function Lock

When set, access to each of the settable parameters above can be turned “off” to prevent unauthorized configuration changes. This is done with password protection in Supervisory Mode. Push **ENTER** to access Supervisory Mode or **CONFIG** to go back to normal operation.

Supervisory Mode

If necessary, each user-configurable parameter can be edited when you receive the Product. Some parameters are locked and must be unlocked to configure them. Use Supervisory mode to do this.

When you are in the Configure menu, and **FUnC LOCK** is shown, it means that there are locked parameters.

To disable function lock:

1. Push **▼** **ENTER**. **0 PWRD** is then shown.
2. The password “101” is required to unlock Supervisory mode. Push **▲** to put in the password entry. Hold **▲** or **▼** down to move faster through the selections by a factor of 10. When you stop the counter, push **▲** and **▼** again to move forward or backward by a factor of 1. The password is factory set and cannot be changed.
3. Push **ENTER**.

From this point each parameter can be locked or unlocked. Push **▲** and **▼** to select **UnLOC** or **LOC** for

each parameter. To move to the subsequent parameter, push **CONFIG**.

You can access, lock, or unlock these functions:

- Zero function (enable/disable)
- Set pressure units (enable/disable)
- Auto shutdown adjustment (enable/disable)
- Damping settings (enable/disable)
- Sample rate setting (enable/disable)
- Tare setting (enable/disable)
- Custom engineering units (set scale factor)

When a function is locked, it cannot be accessed or changed from its current condition until you go to Supervisory Mode and unlock it.

Available Pressure Ranges

Available pressure ranges are shown in the Specifications section.

How to Set a Custom Engineering Unit or Scale

The last menu selection in Supervisory Mode is **SET FACTR**. You can set a multiplier factor from 0.001 to 100 to make a custom scale. The set factor is multiplied by the psi measured and the result is shown.

Example: 40 psi is the equivalent of 1000 lbs of product in a tank. It is necessary to show the product weight with a 100 psi gauge. If you set a factor of 25, 40 psi pressure shows as 1000 (40 x 25). The engineering unit shown is **Cust** (custom).

Battery Life

Battery life is approximately 75 hours of operation with the backlight off. When the battery voltage is low, the low-battery icon (🔋) shows on the top left of the display. To replace the batteries, see the How to Change the Batteries section.

Maintenance

How to Clean the Product

Clean the Product with a soft cloth dampened with water or water and weak soap.

⚠ Caution

To prevent possible damage to the Product, do not use solvents or abrasive cleansers.

⚠ Caution

For safe operation and maintenance of the product:

- **Repair the Product before use if the battery leaks.**
- **Remove batteries to prevent battery leakage and damage to the Product if it is not used for an extended period.**
- **Be sure that the battery polarity is correct to prevent battery leakage.**
- **Have an approved technician repair the Product.**

How to Change the Batteries

⚠⚠ Warning

To prevent possible electrical shock, fire, or personal injury, have an approved technician repair the Product.

To change the batteries, see Figure 2:

1. Pull off the Product cover.
2. Use a Phillips screwdriver to loosen the captive screw on the battery door.
3. Remove the battery door.
4. Replace the three AA batteries.
5. Install the battery door again.
6. Tighten the captive screw on the battery door.
7. Return the Product to its Holster.

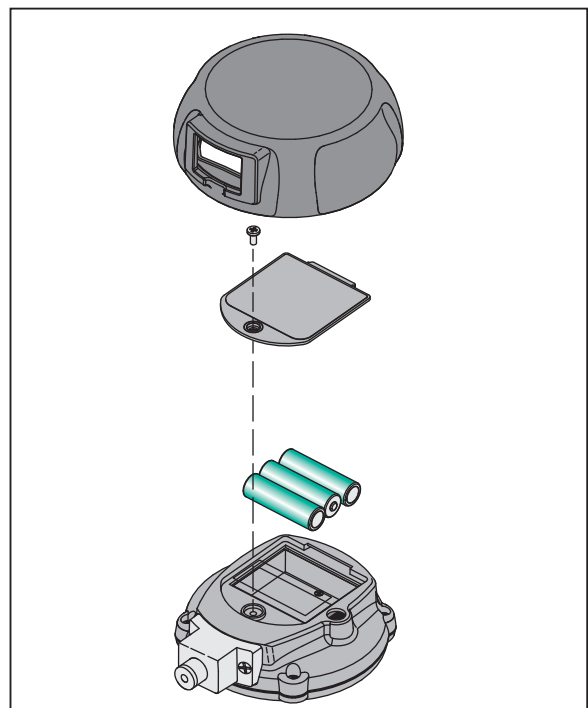

gsn002.eps

Figure 2. Change the Batteries

Accessories

USB Interface Cable

The Product includes an USB interface cable. The input jack is on the back of the Product. You can use serial communication to configure and calibrate the Product and move measurement data from the Product to a PC. For specifications on the interface, see the Specifications section.

Power Module

The Product includes a USB power module. See Figure 3.

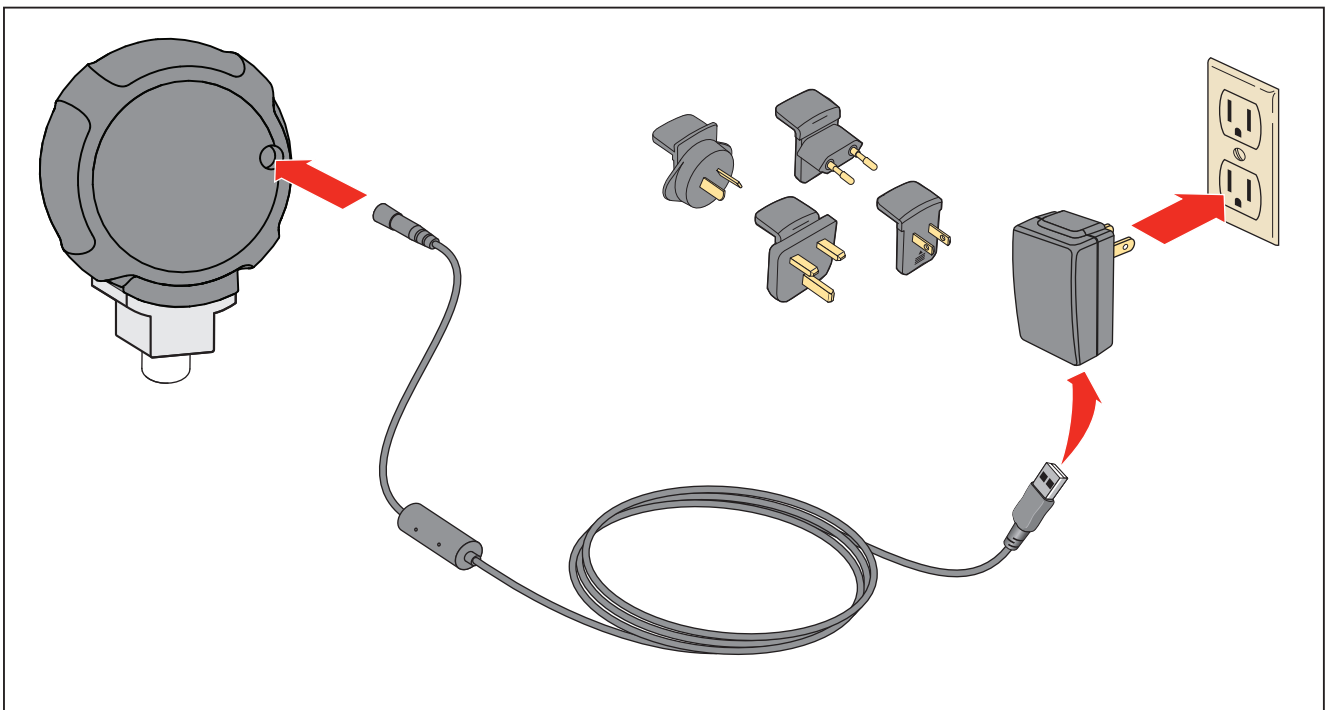

gsn003.eps

Figure 3. USB Power Module and Universal Connectors

Serial Interface Instructions

The subsequent sections tell you how to set up the Product for serial communication.

Initiating Communication

Terminal communication can be setup with terminal communication Software on a PC. The terminal must be set as follows:

- Bits per second: 9600
- Data bits: 8
- Parity: None
- Stop bits: 1
- Flow control: None
- Local echo on

List of Commands

Use the subsequent list of commands to communicate with the Gauge:

*CLS	Clears the error queue
FAULT?	Returns an error code from the error queue
*IDN?	Identification query. Returns the manufacturer, model number, and firmware revision level of the Calibrator.
TARE	Tares the offset pressure of the reading on the calibrator
TARE?	Returns the current tare value
PRES_UNIT?	Returns the pressure unit for the upper display
PRES_UNIT	Sets the pressure unit for the display
ZERO_MEAS	Zeros pressure of the calibrator
ZERO_MEAS?	Returns the current zero offset value
MINMAX_RST	Resets the minimum and maximum recorded values

2700G Series
Users Manual

MIN?	Returns the minimum recorded value
MAX?	Returns the maximum recorded value
TEMP?	Returns temperature in the chosen units
CAL_STORE	Stores calibration data.
CUST_MULT?	Sets the multiplier for the custom unit type
STREAM_OFF	Turns off streaming data
STREAM_ON	Turns on streaming data
VAL?	Returns the measured pressure value in selected units
TEMP_UNIT	Used to set temperature unit
TEMP_UNIT?	Returns temperature unit

Parameter Units

The subsequent list of units is used with the Product:

psi	Pressure in pounds per square inch
bar	Pressure in bars
mBar	Pressure in millibars
kg/cm2	Pressure in kilograms per centimeter squared
inH2O4C	Pressure in inches of water at 4 °C
inH2O20C	Pressure in inches of water at 20 °C
inH2O60F	Pressure in inches of water at 60 °F
mH2O4C	Pressure in meters of water at 4 °C
mH2O20C	Pressure in meters of water at 20 °C
cmH2O4C	Pressure in centimeters of water at 4 °C
cmH2O0C	Pressure in centimeters of water at 20 °C
ftH2O4C	Pressure in feet of water at 4 °C
ftH2O20C	Pressure in feet of water at 20 °C

Units Conversion

See Table 3 for units and their conversion factors.

Table 3. Units Conversion

Unit Name	Conversion Factor (from kPa)	Conversion Factor (to kPa)
psi	0.14503773773	6.894759
bar	0.01	100
MPa	0.001	1000
kgf/cm2	0.010197162130	98.06652
inH2O @ 4 °C	4.014742	0.249082
inH2O @ 20 °C	4.021845	0.248642
inH2O @ 60 °F	4.0185886	0.248844
ftH2O @ 4 °C	0.33456183	2.988984
ftH2O @ 20 °C	0.33515375	2.983705
ftH2O @ 60 °F	0.33488238	2.986123

Table 3. Units Conversion (cont.)

Unit Name	Conversion Factor (from kPa)	Conversion Factor (to kPa)
cmH ₂ O @ 4 °C	10.19744	0.09806383
cmH ₂ O @ 20 °C	10.21549	0.09789056
mH ₂ O @ 4 °C	0.1019744	9.806383
mH ₂ O @ 20 °C	0.1021549	9.789056
kPa	1	1
mbar	10	0.1
inHg @ 0 °C	0.2952998	3.386387
mmHg @ 0 °C	7.500618	0.133322
Torr	7.500618	0.133322
ftSW @ 0 °C	0.325408	3.073062
mSW	0.09918444	10.08222

Specifications



Accuracy

- Positive Pressure..... ±0.02 % FS
 - Vacuum ±0.05 % FS
 - Temperature Compensation 18 °C to 28 °C (65 °F to 82 °F) to rated accuracy
- Note: For temperatures from 0 °C to 18 °C and 28 °C to 50 °C, add .003 % FS/°C

Media Compatibility

- 15, 30 psi any clean dry non-corrosive gas
- 100, 300, 500, 1000 psi any liquids or gases compatible with 316 stainless steel
- Above 1000 psi any non-flammable, non-toxic, non-explosive, non-oxidizing liquid or gas compatible with 316 stainless steel.

Environmental

- Operating Temperature 0 °C to 50 °C (32 °F to 122 °F)
- Storage -20 °C to +70 °C (-4 °F to +158 °F)
- Humidity 10 % to 90 % RH Non-condensing
- Altitude..... 2000 meters (6561.68 ft.)
- Pollution Degree 2
- Agency Approvals.....   

**Reference Pressure Gauge
Specifications**

Mechanical Specifications

Dimensions	(11.4 x 12.7) cm, depth = 3.7 cm (4.5 x 5) in, depth = 1.5 in (Without Protective Cover)
Pressure	
Connection	¼ in NPT Male
Housing	Cast ZNAl
Display	5-1/2 Digits, 16.53 mm (0.65 in) high 20-Segment bar graph, 0 to 100 %
Power	
Battery	three size AA alkaline batteries
Battery Life	75 hours typical without backlight

2700G Series*Users Manual***Available Pressure Ranges**

Model Number	2030-BG100K	2030-BG200K	2030-BG700K	2030-BG2M	2030-BG3.5M	2030-BG7M	2030-G20M	2030-G35M	2030-G70M
Pressure Range (psi)	15	30	100	300	500	1000	3000	5000	10000
Pressure Range (MPa)	0.1	0.2	0.7	2	3.5	7	20	35	70
Vacuum Range (psi)	-15	-15	-12	-12	-12	-12	0	0	0
Vacuum Range (kPa)	-100	-100	-80	-80	-80	-80	0	0	0
Burst Pressure (psi)	45	90	1000	2000	2000	10000	10000	10000	15000
Burst Pressure (MPa)	0.3	0.6	7	14	14	70	70	70	100
Proof Pressure (psi)	30	60	200	600	1000	2000	6000	8000	13000
Proof Pressure (MPa)	0.2	0.4	1.4	4	7	14	40	55	90