



PGM-IR Halogen Monitor

Portable Gas Monitor for Halogen Gases (Refrigerants)

Instruction 3015-4584

Operation and Maintenance

Rev. 12 – March 2016



Patent 6,590,690

Product Leadership • Training • Service • Reliability

WARRANTY

Bacharach, Inc. warrants to Buyer that at the time of delivery this Product will be free from defects in material and manufacture and will conform substantially to Bacharach Inc.'s applicable specifications. Bacharach's liability and Buyer's remedy under this warranty are limited to the repair or replacement, at Bacharach's option, of this Product or parts thereof returned to Seller at the factory of manufacture and shown to Bacharach Inc.'s reasonable satisfaction to have been defective; provided that written notice of the defect shall have been given by Buyer to Bacharach Inc. within two (2) years after the date of delivery of this Product by Bacharach, Inc.

Bacharach, Inc. warrants to Buyer that it will convey good title to this Product. Bacharach's liability and Buyer's remedy under this warranty of title are limited to the removal of any title defects or, at the election of Bacharach, to the replacement of this Product or parts thereof that are defective in title.

The warranty set forth in paragraph 1 does not apply to parts the Operating Instructions designate as having a limited shelf-life or as being expended in normal use (e.g., filters).

THE FOREGOING WARRANTIES ARE EXCLUSIVE AND ARE GIVEN AND ACCEPTED IN LIEU OF (I) ANY AND ALL OTHER WARRANTIES, EXPRESS OR IMPLIED, INCLUDING WITHOUT LIMITATION THE IMPLIED WARRANTIES OF MERCHANTABILITY AND FITNESS FOR A PARTICULAR PURPOSE: AND (II) ANY OBLIGATION, LIABILITY, RIGHT, CLAIM OR REMEDY IN CONTRACT OR TORT, WHETHER OR NOT ARISING FROM BACHARACH'S NEGLIGENCE, ACTUAL OR IMPLIED. The remedies of the Buyer shall be limited to those provided herein to the exclusion of any and all other remedies including, without limitation incidental or consequential damages. No agreement varying or extending the foregoing warranties, remedies or this limitation will be binding upon Bacharach, Inc. unless in writing, signed by a duly authorized officer of Bacharach.

**Register your warranty by visiting
www.mybacharach.com**

Product improvements and enhancements are continuous; therefore the specifications and information contained in this document may change without notice.

Bacharach, Inc. shall not be liable for errors contained herein or for incidental or consequential damages in connection with the furnishing, performance, or use of this material.

No part of this document may be photocopied, reproduced, or translated to another language without the prior written consent of Bacharach, Inc.

Copyright © 2016, Bacharach, Inc., all rights reserved.

BACHARACH[®] is a registered trademark of Bacharach, Inc. All other trademarks, trade names, service marks and logos referenced herein belong to their respective owners.

Table of Contents

1 INTRODUCTION	1
1.1 How to Use This Manual	1
1.2 Warning Statements	1
1.3 Caution Statements	1
1.4 Hazard Symbols on Monitor	1
1.5 Safety Precautions	2
1.6 Unpacking and Initial Checks	2
1.7 Shipping Precaution	3
1.8 Features and Capabilities	3
1.9 Functional Overview	3
1.9.1 General Description	3
1.9.2 Response to the Presence of Multiple Refrigerants	3
1.10 Specifications	4
2 OPERATION.....	5
2.1 Front Panel Display & Controls	5
2.2 Connecting Gas-Sample and Exhaust Lines	5
2.2.1 Overview	5
2.2.2 Connecting the Gas-Sample Line	5
2.2.3 Connecting the Exhaust Line	6
2.3 General Operation	6
2.4 Time Weighted Average (TWA) Operation	7
2.4.1 Overview	7
2.4.2 Starting a New or Continuing TWA/twa	7
2.5 Peak Reading Operation	8
2.6 Leak Detector Operation	8
2.7 Standby Mode	8
2.8 Battery – Charging and Using	8
2.8.1 Charging the Battery	8
2.8.2 Using the Battery	9
2.9 Display Screens.....	9
2.9.1 Initial Power Up	9
2.9.2 Filling the Purge-Air Bag	9
2.9.3 Data Display Screen	10
2.9.4 Function Screens	10
2.10 Gas Alarm.....	12
2.10.1 Gas-Alarm Light	12
2.10.2 Silencing a Gas Alarm.....	13
2.10.3 Viewing the Gas Alarm Log	13
2.11 System Faults.....	13
2.11.1 Functional Overview.....	13
2.11.2 Clearing / Silencing a Fault Alarm.....	13
2.11.3 Viewing the Faults Log.....	14
2.11.4 Fault Codes.....	15
2.12 Clearing the PPM, Alarms and Faults Data	15
2.13 The DIAG Function.....	16
2.13.1 Overview	16
2.13.2 Keypad Functions	16
2.13.3 First Diagnostic Screen	16
2.13.4 Second Diagnostic Screen.....	16
2.14 The Calibration Function	17
2.14.1 Calibration Procedure	17
2.14.2 Adjusting Calibration Factor.....	17
2.15 The P-CHK Function	17
2.15.1 Overview	17
2.15.2 Keypad Functions	17
2.15.3 Screen Display	18
2.16 Print/Plot Logged Gas Levels.....	18
2.17 Downloading Stored Data to a Personal Computer	19

2.18	Importing Saved Data to a Spreadsheet	21
3	MAINTENANCE	23
3.1	Disassembly	23
3.2	Internal Particulate/Hydrophobic Filter Replacement.....	24
3.3	Updating Firmware	24
4	PARTS AND SERVICE	25
4.1	Replacement Parts	25
4.2	Optional Accessories.....	25
4.3	Service Centers	25
Declaration of Conformity		26

1 Introduction

1.1 How to Use This Manual

This manual provides important information on how to operate and service Bacharach's Refrigerant Monitor.

To assure operator safety and the proper use of the monitor, please read, understand, and follow the directions in this manual.

If you have a working knowledge of gas monitors, you will find this manual useful as a reference tool. If you are new to the use of gas monitors, you can educate yourself about the principles of gas detection and the proper operation of this device by reading this manual thoroughly.

1.2 Warning Statements

The use of the word **WARNING** in this manual denotes a potential hazard associated with the use of this equipment. It calls attention to a procedure, practice, or condition, or the like, which if not correctly performed or adhered to, could result in personal injury or death.

1.3 Caution Statements

The use of the word **CAUTION** in this manual denotes a potential hazard associated with the use of this equipment. It calls attention to a procedure, practice, condition, or the like, which if not correctly performed or adhered to, could result in damage to the equipment.

1.4 Hazard Symbols on Monitor

This symbol indicates the need to consult this operating instruction manual when opening the enclosure.



WARNING: A potential risk exists if the operating instructions are not followed.

This symbol indicates the presence of electric shock hazards when the enclosure is opened.



WARNING: To avoid risk of injury from electric shock, do not open the enclosure when power is applied.

1.5 Safety Precautions



HAZARDOUS AREA WARNING: This instrument has not been designed to be intrinsically safe for use in areas classified as hazardous locations. For your safety, **DO NOT** use it in hazardous (classified) locations.



COMBUSTIBLE/FLAMMABLE GAS WARNING: This is NOT a safety device. Some gases which this instrument can detect may be combustible/flammable. When properly configured, this instrument is designed to alarm at concentrations that are lower than the explosive limit of the gas. As such, it is the buyer's responsibility to initiate an immediate planned response to any gas leaks as soon as they are detected. This equipment should NEVER be used to measure or sample gases at or above their respective lower explosive limits.



WARNING: Do not operate this equipment in the presence of flammable liquids, vapors or aerosols. Operation of any electrical equipment in such an environment constitutes a safety hazard.



CAUTION: The protection provided by the monitor may be impaired if the monitor is used in a manner not specified by these instructions. Changes or modifications to this monitor will void the warranty.



IMPORTANT: This device is designed for operation at or below an altitude of 6,562 ft (2,000 m). Do not operate this device above this altitude limit.



NOTE: To clean the outside of the case use a dry cloth. DO NOT use soap and water.

1.6 Unpacking and Initial Checks

Your Refrigerant Monitor was carefully inspected at the factory before shipment, and packed so as to be highly resistant to damage while in transport. When you receive the instrument, however, please unpack it promptly and make a visual inspection to make sure that no damage has occurred during shipment. Also check that all the following items have been received.

Item	Qty	Part Number
Refrigerant Monitor	1	3015-4484
External Filter Assembly	1	3015-5324
Soft Carrying Case with Shoulder Strap	1	3015-5700
Battery Pack & Charger	1	3015-5743
Stainless Steel Probe	1	3015-5326
Instruction Manual	1	3015-4584
Elbow	1	3015-3234
Tubing (3 ft)	1	0003-6182

If damage was found, immediately file a claim with the carrier. If an item is missing, please contact Bacharach's Service Department for assistance (refer to Section *Service Centers*).

1.7 Shipping Precaution

When shipping the instrument by air, deflate the purge-air bag to prevent it from bursting due to changes in air pressure. Deflate the bag by selecting the **EMPTYBAG** function as described on page 10.

1.8 Features and Capabilities

- Detects and measures CFC, HCFC, HFC and halogen gases
- Measures all gases up to 10,000 ppm with a sensitivity of 1 ppm
- Automatically logs up to 200 gas readings that can be recalled later for analysis
- Eliminates false alarms with use of non-dispersive IR source and sample draw system
- Visual and audible gas alarm indicators that are turned ON when the detected gas level exceeds a user defined trip-point
- Extensive self diagnostics, providing both visual and audible indications when a fault occurs
- Battery powered, providing a minimum of 8 hours of operation

1.9 Functional Overview

1.9.1 General Description

The Bacharach Refrigerant Monitor is a portable refrigerant gas monitor. The unit is designed to test for a specific refrigerant gas for the purpose of determining the presence and level of that gas being tested. The monitor self-zeros every 4 minutes to ensure accurate gas measurements.

During normal operation the HM unit displays the type of gas being monitored; along with displaying both the current gas level and the peak gas level detected in that area on its front panel LCD. The monitor retains a log of previous readings that can be easily accessed at a later time for analysis.

Front panel indicators and an audible alarm are provided to signal gas alarm and instrument fault conditions. The audible alarm can temporarily be silenced by a push of a button, but will reactivate if the gas level is still above the alarm trip point after a user defined time period has elapsed.

The HM unit requires only minor periodic maintenance such as the occasional replacement of filters. The monitor incorporates active diagnostics that continuously check the system for proper operation. A front panel indicator is provided to alert an operator of system malfunctions, and fault codes are generated that enable the operator to identify the cause of the fault.

1.9.2 Response to the Presence of Multiple Refrigerants

The HM is a refrigerant level monitor, not a gas analyzer. You must program the monitor to test for a specific refrigerant, and it will only return accurate concentration readings for that particular refrigerant. When other types of refrigerant gas are present, the monitor may return incorrect readings.

Most applications only require detection of a single refrigerant and the problems that are associated with monitoring multiple gases are rarely an issue. If there is a possibility of multiple refrigerants leaking in the same sampling zone, then you should carefully consider which refrigerant compound you program the unit to monitor.

1.10 Specifications

Product Type Portable refrigerant gas monitor

Gas Library:

CFC:	R-11, R-12, R-113, R-114, R-502, HFP
HFC:	R-404a (HP62), R-407a, R-407c (AC9000), R-134a, R-410a (AZ20), R-507 (AZ50), R-508b (SUVA95), R236FA, R125, R245Fa, R422a, R422d, R427a, R424a, R426a and R438a
HCFC:	R-22, R-123, R-124, R-500, R-503, R-401a (MP39), R-402a (HP80), R-402b (HP81), R-408a, R-409a, R-23, R21, R227
HALON:	H1301, H2402, H1211
Other:	FA188, FC72, N1230, H1234YF, H1234ZE, N7000, N7200, N7300, N7600

Measuring Range All gases 0 to 10,000 ppm

Warm-Up Time 5 minutes (300 seconds)

Detector Type Infrared, Non-Dispersive

Sensitivity 1 ppm

Accuracy ± 1 ppm $\pm 10\%$ of reading from 0-1000 ppm

(For R11, R22, R113: ± 10 ppm $\pm 15\%$ of reading from 0-1000 ppm)

Response Time 90% of response within 5 seconds; 100% in 7 seconds

Temperature Drift 1.5 ppm per °C between purge cycles

System Noise Less than 40dB (A) at 10 ft (3 m)

Operating Temperature 32 to 122°F (0 to 50°C)

Ambient Humidity 5 to 90% RH (non-condensing)

Altitude Limit 6,562 ft (2,000 m)

Power DC power pack, provides a minimum of 8 hours of operation

Power Consumption 15 Watts maximum

Front panel 3 indicator lights:

ON Green LED flashes during warm-up, then glows steadily during normal operation

FAULT Yellow LED flashes when there is a system fault

ALARM Red LED flashes when the gas level is above its alarm setting

Audible Alarm Internal audible alarm programmable for any of the following conditions:
OFF, FAULT/ALARM, ALARM

Dimensions (D x L x W) 9.0 x 14.5 x 5.0 inches (229 x 368 x 127 mm)

Weight Less than 9 lbs (4 kg) including battery

Valid Calibration Period
to Specifications 12 months

Warranty 2 years from date of shipment

2 Operation

2.1 Front Panel Display & Controls

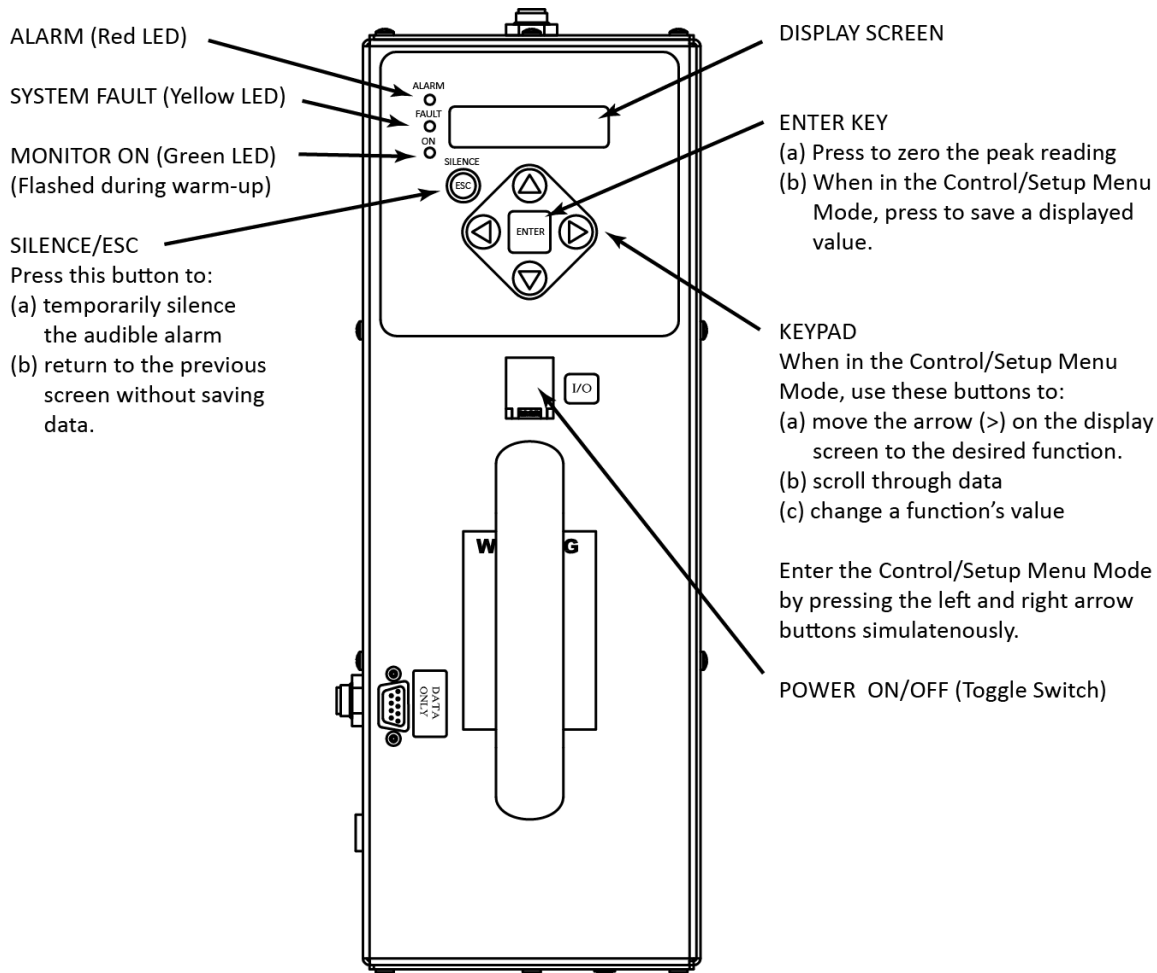

2.2 Connecting Gas-Sample and Exhaust Lines

2.2.1 Overview

A single gas-sample line needs to be run from the HM unit to the area to be monitored. An optional purge-air line can also be installed to bring fresh air into the monitor for the purpose of resetting its infrared detector to a baseline of 0 ppm during the purge cycle. Also, an optional exhaust line can be installed to vent refrigerant gas away from the monitor.

2.2.2 Connecting the Gas-Sample Line

To connect the gas-sample line to the monitor, simply push the tubing onto the elbow connector and attach the elbow onto the Gas Sample Port on the front of the monitor as shown in the illustration below.

The gas-sample line can be up to **50 ft (15.2 m)** in length. All tubing bends should have a radius of no less than 5" to ensure proper airflow. If kinks or obstructions occur in the line the monitor may not function properly.

The end of this line should be placed near the potential leak source and positioned to reduce the possibility of mists, aerosols, oil, water, dust, or other contaminants being drawn into the monitor.

An external filter (P/N 3015-5324) should be attached to the end of this line (see figure below).

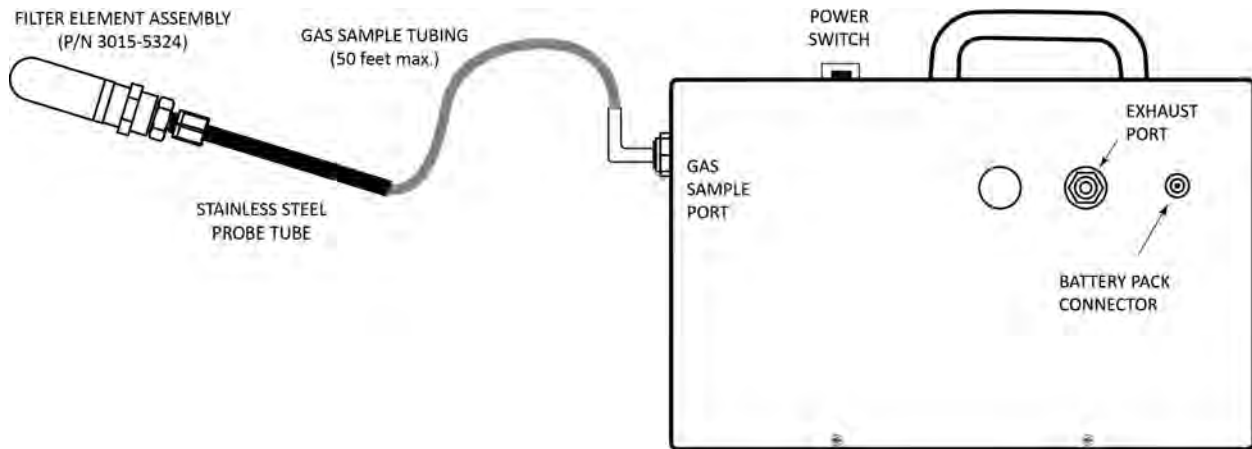

2.2.3 Connecting the Exhaust Line

The exhaust line carries the exhausted gas sample away from the monitor, and is required if the monitor is located in a confined, poorly ventilated area.

The exhaust line can be up to **50 ft (15.2 m)** in length. Ideally this line should terminate outdoors in a location that is not exposed to the elements.

Connect the exhaust line to the monitor by firmly pushing the tubing into the Exhaust Port's push-to-connect (PTC) fitting. See below. If the exhaust line terminates outside the building, position the tubing so that no water or moisture can enter the line. Note that this line does not require a termination filter.

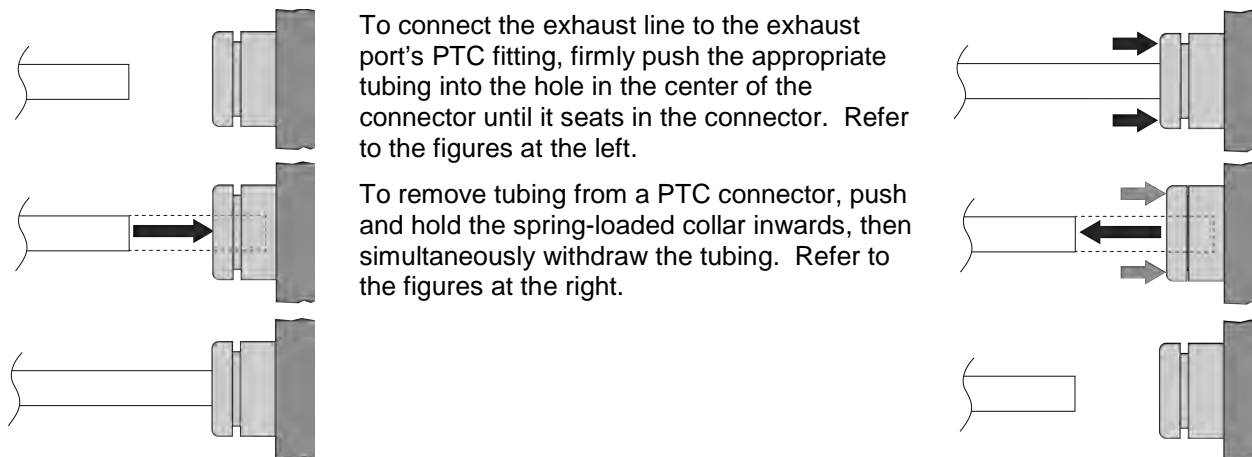

2.3 General Operation

WARNING: Operate the monitor in its horizontal position (handle facing upwards). Tilting the monitor to a vertical position while in operation may cause inaccurate measurements to occur.

To turn ON the monitor, lift up the shield located in front of the handle and press the red power ON/OFF toggle switch.

When the monitor has been powered ON, allow it to warm up for 5 minutes.

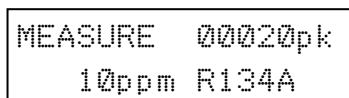

MEASURE indicates when the monitor is actively measuring gas. The screen to the left shows that currently 10 ppm of R-134A refrigerant gas is being detected, and that a peak measurement of 20 ppm has been made. The operator can reset the peak value to zero by pressing the **ENTER** button. The measurement cycle runs for 4 minutes. A log of up to 200 previous measurements can be viewed using the **PPM LOG** function (page 10).

```
PURGE      00020pk
100ppm R134A
```

PURGE indicates when the monitor is resetting its infrared detector to a baseline of 0 ppm. The purge cycle runs for 10 seconds.

If the detected gas level exceeds a preset gas-alarm point, the unit will respond by turning ON the front panel **ALARM** (red) light. If the **AUDALRM** function is activated (page 11), the audible alarm will also turn ON. Pressing the front panel **SILENCE** button turns OFF the audible alarm, but the **ALARM** light will continue to flash as long as the detected gas level is above the alarm point. The audible alarm will reactivate if the gas-alarm condition is not cleared within the time period set by the **SILENCE** function (page 11).

If a system fault occurs (see Fault Code list on page 15), the monitor responds by turning ON the front panel **FAULT** (yellow) light. If the **AUDALRM** function is activated (page 11), the audible alarm will also turn ON. Pressing the front panel **SILENCE** button turns OFF the audible alarm, but the **FAULT** light will continue to flash as long as the fault is present. The audible alarm will reactivate if the fault condition is not cleared within the time period set by the **SILENCE** function (page 11). Both the **FAULT** light and audible alarm will automatically turn OFF after the cause of the fault has been eliminated.

A log of the last 30 fault events can be viewed using the monitor's **FAULTS** function (page 10).

2.4 Time Weighted Average (TWA) Operation

2.4.1 Overview

In addition to displaying the current gas level, the monitor can also calculate and display a Time Weighted Average ppm value. This value is available in two formats (8 Hour or Continuous). This provides users with the most appropriate data on their average ppm exposure in the working environment.

TWA operation is selected by using the **2ndUNIT** function.

The two TWA formats are identified by the appearance of either "TWA" or "twa" in the upper-right corner of the **Data Display** screen.

- **TWA** (upper case letters) is calculated over an 8-hour period. This format is designed to show the user's average ppm exposure level during a typical work day. After 8 hours has expired, an asterisk (*) will be displayed but the TWA will continue to be updated.

```
PURGE      00TWA
100ppm     R134A
```

- **twa** (lower case letters) is continuously calculated over the operating time of the monitor. This mode is useful for monitoring an area for a few minutes or more and is the preferred mode of operation for checking operating room atmospheres.

```
PURGE      00twa
100ppm     R134A
```

2.4.2 Starting a New or Continuing TWA/twa

When the monitor is turned ON the following message appears if the monitor is set up to display TWA/twa.

```
PRESS ENTER FOR
NEW TWA/twa
```

Press either . . .

- **ENTER** to start a new TWA/twa
- **ESC** to continue with the current TWA/twa.

Tip: If **NO** button is pressed within 60 seconds the monitor automatically continues with the current TWA/twa.

Note: During the time the monitor is OFF, the gas measurement is assumed to be zero and will be factored into the TWA/twa calculation.

After selecting whether to start or continue a TWA/twa, the next screen shows the current elapsed TWA/twa time.

```
ELAPSED TWA TIME
IS xx MINUTES
```

Where: xx is the accumulated time used by the monitor in calculating the TWA/twa.

2.5 Peak Reading Operation

In addition to displaying the current halogen level, the monitor can also be set up to display its peak ppm measurement. The peak reading display is selected by using the **2ndUNIT** function.

```
PURGE    00020pk
100ppm   R31A
```

The display above shows that currently the monitor is detecting 100 ppm R31A and that a peak measurement of 500 ppm has occurred.

The peak reading is reset by pressing the **ENTER** button.

2.6 Leak Detector Operation

The monitor can be configured to operate as a Leak Detector by setting the **AUDALRM** function (page 11) to **LEAK DETECTOR**.

When configured as a Leak Detector, the monitor will produce a leak detector type of audible feedback. At zero ppm there will be a tic every 2 seconds with the tic rate increasing up to 20 tics/second when the ppm level reaches the **ALRMLVL** setting.

2.7 Standby Mode

After becoming operational, the monitor can be placed into a Standby Mode. When taken out of standby the monitor is ready for operation without waiting an additional 15 minutes to warm up. While in standby the monitor will stop taking gas samples and stops purging itself from the purge-air bag.

Place the monitor into its Standby Mode by pressing both the **ENTER** and **ESC** buttons at the same time.

```
STAND BY
```

Take the monitor out of standby by again pressing both the **ENTER** and **ESC** buttons.

2.8 Battery – Charging and Using



IMPORTANT: If you replace the original PGM-IR battery, refer to the installation instructions included in the replacement kit, as the new replacement battery and cable may differ from the original cable and battery.



IMPORTANT: Cables and sockets are sized appropriately. As general rules of thumb:

- Note the initial orientation of your power cable, and
- Never force a connector into a socket.

2.8.1 Charging the Battery

The monitor is powered by a rechargeable battery pack located in a pouch on the side of the monitor's soft carrying case. The battery pack can be recharged at any time, regardless of the battery's current

charge state. The lithium-ion battery will likely be partially charged. However, you should fully charge the battery prior to operating the PGM-IR. Refer to the battery manufacturer's instruction sheet for the proper charging procedure.

2.8.2 Using the Battery

To properly use the battery, follow the steps below.

1. The PGM-IR is designed for a 16VDC input. Set battery voltage output to 16V (refer to the battery manufacturer's instruction sheet for details).
2. The battery pack provided with your PGM-IR uses a power cable with a straight connector and a 90-degree elbow connector. The battery provided with your PGM-IR may differ slightly from the photos shown in this manual, however, the 90-degree elbow connector must ALWAYS be the connector used to supply power to the PGM-IR. Refer to the figure below.



3. Ensure that the battery is powered ON per the instruction label on the battery pack.
4. Verify that the battery is properly connected to the PGM-IR (see above).

A fully charged battery pack will power the monitor for a minimum of 8 hours.

2.9 Display Screens

2.9.1 Initial Power Up

When the monitor is first powered up, all front panel lights turn ON and a splash screen appears showing the monitor's current firmware revision level. After a brief moment the **Warm Up** screen is displayed along with the front panel **ON** light (green) blinking.

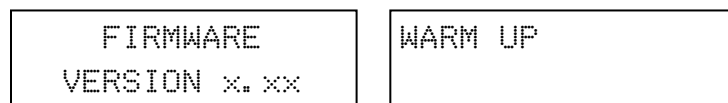

The monitor requires 5 minutes to warm up; after which, the **ON** light glows steadily and the **Data Display** screen is displayed.

If the monitor is turned OFF and then turned back ON, the latter warm-up time may be less than 15 minutes depending on the temperature of the IR detector.

2.9.2 Filling the Purge-Air Bag



CAUTION: Fill the purge-air bag in a clean, fresh-air environment that is at the same temperature and humidity as the area being checked for gas. DO NOT fill the bag in an area that is contaminated with gas.

The following message is displayed and an audible alarm is sounded when the monitor's purge-air bag is empty. This message appears immediately after warm-up, and approximately every 40 minutes during normal operation. Press the **ENTER** button to start the refill process.

PURGE AIR EMPTY <ENTER> TO FILL	RECHARGING PURGE AIR...
------------------------------------	----------------------------

After the air bag has been filled, the monitor starts or resumes normal operation by displaying the **Data Display** screen.

2.9.3 Data Display Screen

MEASURE 00020pk 10ppm R134A	PURGE 00020pk 10ppm R134A
--------------------------------	------------------------------

During normal operation, the **Data Display** screen shows when the monitor is performing the following two functions:

MEASURE indicates that the monitor is actively measuring gas. In the screen shown above, 10 ppm of R-134A gas is currently being detected, and that a peak measurement of 20 ppm has occurred sometime in the past. The measurement cycle runs for 4 minutes.

To reset the peak value to zero, press the **ENTER** button.

2.9.4 Function Screens

The Function screens are used to set up the monitor and display stored data.

From the **Data Display** screen, press both the **Keypad Left** and **Right** buttons at the same time to display the first **Function Menu** screen. Next, use the **Keypad** buttons to move the arrow (>) until it points to the desired function, and then press the **ENTER** button to select that function.

>FILLBAG EMTYBAG ALRMLVL AUDALRM	>PPM LOG LOG INT FAULTS DIAG	>SILENCE P-CHK GAS CLOCK
>2ndUNIT PRINT PLOT PC-DUMP		

Once a function has been selected, use the **Keypad** to scroll through the displayed data or to change a parameter associated with that function. Press **ENTER** to save any newly entered parameters. Press the **ESC** button to return to the previous screen without saving.

Note that if no buttons are pressed within 90 seconds after selecting a function, the unit returns to the **Data Display** screen.

FILLBAG – Press **ENTER** to manually fill the purge-air bag.

FILLING BAG...



WARNING: Fill the purge-air bag in a clean, fresh-air environment that is at the same temperature and humidity as the area being checked for gas. DO NOT fill the bag in an area that is contaminated with gas.

EMTYBAG – Press **ENTER** to manually empty the purge-air bag. Use this function to drain the bag if it becomes contaminated with gas.

DRAINING BAG...

ALRMLVL – Detected gas level that causes the front panel **ALARM** (red) light to turn ON and the audible alarm to sound (if AUDALRM function is set to ALARM or ALARM/FAULT).

EDIT ALARM LEVEL 300 ppm

AUDALRM – The internal audible alarm is programmable to function as follows:

```
AUDIBLE ALARM IS
ALARM
```

- **OFF** – Audible alarm is disabled.
- **ALARM** – Alarm sounds when detected gas level exceeds the ALRMLVL level as evidenced by the front panel ALARM (red) light turning ON.
- **ALARM/FAULT** – Alarm sounds when either the detected gas level exceeds the ALRMLVL value, or if a system fault occurs, as evidenced by the front panel ALARM (red) light or FAULT (yellow) light turning ON.
- **LEAK DETECTOR** – When selected, the monitor will produce a leak detector type of audible feedback. At zero ppm there will be a tic every 2 seconds with the tic rate increasing up to 20 tics per second when the ppm level reaches the ALRMLVL setting.
- **TWA ALARM** – Audible alarm sounds when the TWA or twa, whichever is selected by the **2ndUNIT Function**, exceeds the ALARMLVL value.

The audible alarm can be temporarily silenced by pressing the **SILENCE** button.

PPM LOG – Contains records of the last 200 measurements. Each record shows the measurement's date, time, and ppm level. Measurements are logged at an interval determined by the **LOG INT** function. After all 200 locations are filled the newest entries overwrite the oldest entries.

```
#025      7PPM @
07/11/05  15:35
```

Use the **Keypad Up** and **Down** buttons to change the record number by a factor of 1. Use the **Right** and **Left** buttons to change the record number by a factor of 10. Press **ESC** to return to the previous screen.

To the right, record #025 shows that a gas level of 7 ppm was measured on 07/11/2005 at 3:35 PM.

The PPM Log can be cleared using the information discussed in *Clearing the PPM, Alarms and Faults Data* on page 15.

LOG INT – Sets the interval at which measurements are logged to memory from 1 to 9999 minutes. Factory default is 1 minute. The logged measurements can be viewed using the **PPM LOG** function. Use the **Keypad** to enter the desired value, and then press **ENTER** to save that value and return to the previous screen.

```
LOG INTERVAL IS
0001 min
```

FAULTS – Contains records of the last 30 fault events. The most recent event is displayed when the **Fault** screen is first displayed. After 30 events have been recorded, the newest record overwrites the oldest. Each record lists an event's numeric fault code (refer to Section 2.11.4 *Fault Codes* on page 15) plus the date and time at which the event occurred. Use any of the **Keypad** buttons to scroll through the other fault events. Press **ESC** to return to the previous screen.

```
#15 <1000> @
07/11/05  12:37
```

To the right, record #15 shows that a Purge Flow Fault (fault code <1000>) occurred on 07/11/2005 at 12:37 PM.

DIAG – Enters the diagnostic function. Refer to Section 2.13.

```
4.2159v <0000>
29.05cD 14.58psi
```

SILENCE – Sets the length of time the internal audible alarm is turned OFF when the front panel **SILENCE** button is pressed. The factory default is 30 seconds. If the cause of the gas-alarm has not been cleared at the end of this time period, the internal audible alarm will reactivate. Use the

```
SILENCE TIMEOUT
0030 sec
```

Keypad to enter the desired time period, and then press **ENTER** to save that value and return to the previous screen.

P-CHK – The **Pressure Check** function displays the current manifold pressure and the stored ambient pressure in psia, along with the difference between these two pressures and the current fault code. Refer to Section 2.15.

```
14.07 * AMB14.05
-0.02dif <1000>
```

GAS – Used to select one of any of the gas types available for monitoring. Factory default is R-134A. Note that the factory can program a custom gas type as specified on the sales order. Use the Keypad to select the desired gas type, and then press ENTER to save the selection and return to the previous screen.

```
SELECT GAS TYPE
R134A
```

CLOCK – Sets the monitor's date and time. Use the **Keypad** to enter the correct date and time, and then press **ENTER** to save those values and return to the previous screen. Note that time is displayed in a 24 hour format, while the date is displayed as mm/dd/yy.

```
SET DATE & TIME
07/11/05 15:30
```

2ndUNIT – One of following second measurements can be selected to appear in the upper-right hand corner of the **Data Display** Screen:

- **NONE** – Blank
- **Peak PPM** – Peak gas reading
- **Cont twa** – Time Weighted Average calculated on a continuous basis
- **8hr TWA** – Time Weighted Average calculated over an 8 hour period

```
MEASURE 00500pk
100ppm SF6
```

PRINT – Refer to Section 2.16 *Print/Plot Logged Gas Levels* on page 17.

```
2ndUNI >PRINT
PLOT PC-DUMP
```

PLOT – Refer to Section 2.16 *Print/Plot Logged Gas Levels* on page 18.

```
2ndUNIT PRINT
>PLOT PC-DUMP
```

PC-DUMP – A personal computer can be connected to the monitor's DB9 RS-232 connector for the purpose of downloading logged ppm measurements. These measurements can later be analyzed using any common spreadsheet program. Refer to Section 2.17 *Downloading Stored Data to a Personal Computer* on page 19 for detailed instructions on how to transfer stored data to a personal computer.

```
2ndUNIT PRINT
PLOT >PC-DUMP
```

2.10 Gas Alarm

2.10.1 Gas-Alarm Light

If the detected gas level reaches one the gas-alarm levels as set by the **LEAKLVL**, **SPILLVL**, or **EVACLVL** functions, the front panel **ALARM** light will flash and the audible alarm, if activated (refer to **AUDALRM** function page 11), will start beeping. The **ALARM** light and audible alarm will automatically turn OFF once the detected gas level drops below the gas-alarm level.

2.10.2 Silencing a Gas Alarm

Pressing the **SILENCE** button while the alarm circuit is activated causes the internal audible alarm to turn OFF for a period of time as set by the **SILENCE** function (page 11). The front panel **ALARM** light will continue to flash, however, as an indication that an alarm condition still exists. The audible alarm will reactivate at the end of the silence period if the detected gas level is still above the gas-alarm level.

2.10.3 Viewing the Gas Alarm Log

From the **Data Display** screen, press any of the **Keypad** buttons to display the first **Function Menu** screen. Next, use the **Keypad** buttons to move the arrow (>) until it points to the **ALARMS** function, and then press the **ENTER** button to display the **Alarm Log** screen.

The alarm log shows the type of alarm (LEAK, SPILL, or EVAC), plus the date and time it occurred. If CLEAR is displayed, this indicates that an alarm was acknowledged at the date and time shown.

Immediately after selecting the **ALARMS** function, the most recent alarm event is displayed. In the example to the right, record #03 shows that a Spill Alarm occurred on 06/10/05 at 15:06. Note that if more than 30 alarm events have occurred, then the newest event overwrites the oldest.

#03	SPILL @
06/10/05	15:06

Note that the Alarm Log can be cleared as described in Section *Clearing PPM, ALARMS & FAULTS Data* (page 15).

2.11 System Faults

2.11.1 Functional Overview

If a system malfunction occurs (see Fault Code list, page 15), the front panel **FAULT** light will flash and the audible alarm, if activated (refer to **AUDALRM** function page 11), will start beeping.

2.11.2 Clearing / Silencing a Fault Alarm

The **FAULT** light and audible alarm will automatically turn OFF after the cause of the fault has been eliminated.

Pressing the **SILENCE** button while a fault condition still exists causes the internal audible alarm to turn OFF for a period of time as set by the **SILENCE** function (page 11). The front panel **FAULT** light will continue to flash, however, as a reminder that a fault condition still exists. The audible-alarm circuit will reactivate at the end of the silence period if the cause of the fault has not been corrected.

2.11.3 Viewing the Faults Log

From the **Data Display** screen, press any of the **Keypad** buttons to display the first **Function Menu** screen. Next, use the **Keypad** buttons to move the arrow (>) until it points to the **FAULTS** function, and then press the **ENTER** button to display the **Faults Log** screen.

```
#03 <0800> @
07/11/05 08:17
```

```
#04 <0000> @
07/11/05 09:00
```

```
FAULT CODE<1800>
12 SAMPLE FLOW
```

```
FAULT CODE<1800>
13 PURGE FLOW
```

The **Faults Log** screen shows the monitor's current fault status. If the fault is still present when the **FAULTS** function is selected, then the current cause of the fault is displayed along with the date and time it occurred. If the cause of the fault has been cleared, then the **Faults Log** screen will show <0000> along with the date and time the fault was cleared. Use the **Keypad** buttons to scroll through the fault log. In the screens shown to the left, record #03 shows that a Sample Flow Fault (fault code <0800>) occurred on 07/11/05 at 08:17, while record #04 shows that the fault was cleared on 07/11/05 at 9:00.

The cause of the fault is identified by a numeric fault code. To convert the fault code into a text description of the fault, first press the **ENTER** button and then use the **Keypad** buttons to scroll through the display until the text description of the fault appears. If the fault code is a combination of two or more faults, then continue to use the **Keypad** buttons until all fault text descriptions have been displayed. For example, the fault code <1800> represents the combination of both a Sample Flow <0800> and a Purge Flow <1000> fault as shown to the left.

The Fault Log can be cleared as described in *Clearing the PPM, Alarms and Faults Data* on page 15.

2.11.4 Fault Codes

FAULT CODES ARE ADDITIVE. For example: A fault code of <0003> indicates that both a Box Temperature Fault <0001> and a Bench Temperature Fault <0002> have occurred.

Code	Fault Name	Description
<0001>	Box Temperature Fault	Enclosure temperature is outside normal range (or IR detector has failed). Check that the monitor is not being subjected to extreme temperatures. Use the DIAGNOS function to check the Box Temperature.
<0002>	Bench Temperature Fault	Optical bench is outside normal operating range (or IR detector has failed). Check that the monitor is not being subjected to extreme temperatures.
<0004>	Manifold Pressure Fault (Sensor 1)	The manifold pressure is outside its normal operating range (or IR detector has failed). Enter the DIAGNOS function and record ALL data. Call the factory with this information for further instructions.
<0020>	Manifold Pressure Fault (Sensor 2)	See fault code <0004>.
<0040>	Fill Flow Fault	The purge-air bag's pressure drop is outside expected limits. Check for a punctured bag or disconnected tubing.
<0080>	Over Range Fault	Monitor exposed to a gas level that exceeded 65,000 ppm.
<0100>	Zero Filter Fault	The purge-air bag is contaminated with gas. Take monitor to a clean-air area and use the EMPTYBAG and FILLBAG functions to decontaminate the purge-air bag. If an external filter is used, it may need to be replaced.
<0200>	Gain Set Fault	The digipot autotune sequence has failed. This fault will only occur on first boot up or after a firmware upgrade. Call the factory for further instructions.
<0400>	A/D Fault	A fault has occurred in the analog-to-digital circuitry. Contact the factory with this information for further instructions.
<0800>	Sample Flow Fault	Check for: A restriction in the gas-sample inlet or exhaust; a blocked internal filter; or a failed pump.
<1000>	Purge Flow Fault	Check for: A restriction in the gas-sample exhaust; a blocked internal filter; or a failed pump. Once the purge air stream has been restored, the monitor will return to normal operation after it completes a purge cycle.
<2000>	Bag Fill Fault	The purge-air bag did not fill within the expected time allotment. Check for a punctured bag or disconnected tubing.
<4000>	Zero Range Fault:	The IR detector's output voltage is out of tolerance. Enter the DIAGNOS function and record all data. Call the factory with this information for further instructions.
<8000>	Clipping Fault	The detector voltage may be out of tolerance. Use the DIAGNOS function to check the IR detector voltage. Call the factory with this information for further instructions.

2.12 Clearing the PPM, Alarms and Faults Data

Up to 200 gas measurements and 30 alarm and fault events are stored by the monitor.

To clear stored data, first display the data to be cleared by selecting the **PPM LOG**, **ALARMS** or **FAULTS** function. Next, press both the **ENTER** and **Keypad Right** buttons at the same time. A single, long tone should be heard when the data has been successfully cleared.

2.13 The DIAG Function

2.13.1 Overview

The **DIAG** function displays sensor data and status information useful to a service technician for troubleshooting various fault conditions. Explanations of the data shown in these screens are given below.

2.13.2 Keypad Functions

From the **Data Display** screen, press any one of the **Keypad** buttons to display the first **Function Menu** screen. Next, use the **Keypad** buttons to move the arrow (>) until it is next to the **DIAG** function, and then press **ENTER** to display the first of two **Diagnostic** screens.

Press the **Keypad Up** button to toggle between the **First** and **Second Diagnostic** screen.

2.13.3 First Diagnostic Screen

4.20885v <0000> 29.05cD 14.58psi	Bench Voltage Fault Code Detector Temperature °C * Pressure Reading
0.00075n <0000> 35.40cB 14.59psi	Noise Fault Code Box Temperature °C * Pressure Reading

In the **First Diagnostic** screen, the user can toggle between displaying Bench Voltage / Detector Temperature, and Noise / Box Temperature by pressing the **Keypad Right** button.

Bench Voltage – This is the current peak-to-peak output of the IR detector. In the absence of gas this value can range from 3.90000V to 4.50000V.

Noise – The Noise value is a 16 point running average of the noise portion of the IR detector's output. This reading is valuable mainly when gas is NOT present.

Detector Temperature – This is the current detector temperature in °C.

Box Temperature – This is the current internal enclosure temperature in °C.

Fault Code – Current fault code. A value of <0000> indicates that no faults are being detected.

Pressure Reading – This is the pressure as measured every purge cycle with the sample pump off and the gas-sample inlet open. Its value is weather and altitude dependent and can range from 10.0 to 15.5 PSIA.

Purge Valve Asterisk (*) – The purge valve can be opened and closed by pressing the **Keypad Left** button. An asterisk appears on the display when the purge valve is *open* causing the monitor to draw air from its purge-air port.

2.13.4 Second Diagnostic Screen

0.1ppm 0.01 0.00004au 4.210v	PPM Level μMole/Liter Avg. Absorption Unit * Detector Voltage
---------------------------------	--

PPM Level – Parts Per Million Level is the current detected gas level, and is the volume concentration referenced to standard temperature and pressure.

Average Absorption Unit – This is the optical absorbency. In the absence of gas the absorbency is 0.00000 au. When sampling gas, its value varies proportionally with the gas concentration.

μMoles/Liter – This is the absolute concentration in micro-moles per liter of gas.

Detector Voltage – This is a running average of the IR detector's bench voltage.

Purge Valve Asterisk (*) – The purge valve can be opened and closed by pressing the **Keypad Left** button. An asterisk appears on the display when the purge valve is *open* causing the monitor to draw air from its purge-air port.

2.14 The Calibration Function

If greater than standard accuracy is desired, the factory's default calibration factor of 1.000 may be adjusted by performing the calibration procedure as described below, and then selecting the monitor's **CAL** function to enter the new calibration factor.



IMPORTANT: Changing the calibration factor will VOID the factory calibration. Typically, the monitor will remain within the factory-calibrated accuracy indefinitely and no calibration is required. Complex software algorithms adjust for temperature drift, IR source aging, and pressure changes in order to keep the unit within factory accuracy specifications.

2.14.1 Calibration Procedure

The calibration factor is determined by sampling a known concentration of R-134A refrigerant gas. A cylinder of a certified calibration gas must be used to ensure that the gas sample is a known concentration at ambient conditions. A minimum sample size of 5 liters is required.

Calibration is best performed at or near full scale (1,000 ppm). It can, however, be done at any concentration and ideally in the range where maximum accuracy is desired down to, but not below, 100 ppm.

The monitor should be operating for at least one hour prior to performing a calibration.

Prepare the monitor for sampling by using the **CAL** function to set the calibration factor to 1.000. Also, use the **LOG INT** function to set the log interval to 1 minute.

With the monitor operating normally, connect the gas-sample bag directly to the gas-inlet port and allow the monitor to sample the entire bag. When sampling is complete, view the logged ppm values using the **PPM LOG** function. If the bag was large enough for multiple samples, average the most stable ones. The new calibration factor is computed by dividing the known gas concentration value by the measured value. Typically this number will be between 0.95 and 1.05. Use the **CAL** function as described below to enter the new calculated calibration factor

2.14.2 Adjusting Calibration Factor

```
R134A CALFACTOR
1.000
```

From the **Data Display** screen, press any one of the **Keypad** buttons to display the first **Function Menu** screen. Next, use the **Keypad** buttons to move the arrow (>) until it is next to the **CAL** function, and then press **ENTER** to display the **Calibration** screen.

With the **Calibration** screen displayed, use the **Keypad** buttons to enter the new calibration factor. Press **ENTER** to save this value.

2.15 The P-CHK Function

2.15.1 Overview

The **P-CHK** function (Pressure Check function) is useful to a service technician for troubleshooting a flow-fault problem. The monitor will trigger a flow fault if the pressure drop from ambient is less than 0.2 psi during a purge cycle, and 0.5 psi during a measurement cycle.

2.15.2 Keypad Functions

From the **Data Display** screen, press both the **Keypad Left** and **Right** buttons at the same time to display the first **Function Menu** screen. Next, use the **Keypad** buttons to move the arrow (>) until it points to the **P-CHK** function, and then press **ENTER** to display the **Pressure** screen.

The **Keypad Left** button toggles the purge valve open and closed. Note that an asterisk (*) appears when the purge valve is *open* causing the monitor to draw air from the purge-air bag.

The **Keypad Down** button toggles the pump ON and OFF.

Pressing the **ENTER** button stores the current manifold pressure shown on the left to the ambient pressure shown on the right (must be done with the pump OFF).

2.15.3 Screen Display

14.59	AMB14.75	Current Manifold Pressure	*	Stored Ambient Pressure
-0.16dif	<0000>	Pressure Difference		Fault Code

Current Manifold Pressure – Current manifold pressure in psia.

Stored Ambient Pressure – Stored ambient pressure in psia.

Pressure Difference – The difference between the current manifold pressure and the stored ambient pressure.

Fault Code – Current fault code (see page 15).

Purge Valve Asterisk (*) – The purge valve can be opened and closed by pressing the **Keypad Left** button. An asterisk appears on the display when the purge valve is *open* causing the monitor to draw air from the purge-air bag.

2.16 Print/Plot Logged Gas Levels

A printout or plot of the last 200 ppm measurements can be made by connecting the optional Bacharach printer and printer cable to the monitor as follows. (Refer to Replacement Parts on page 25 for printer and cable part numbers).

- For a printout or plot to be made, the monitor must have been set up to record gas measurements using the **LOG INT** function.
- Interconnect the RS-232 connectors located on the printer and monitor.
- If not already done, refer to the printer manual and set the printer's communication parameters to:
 - Data bit = 8
 - Parity = None
 - Baud rate = 19200
 - Handshaking = DTR
- From the **Data Display** screen, press *any* **Keypad** button to display the first **Function Menu** screen. Next, use the **Keypad** buttons to move the arrow (>) until it points to either **PRINT** to produce a printout, or **PLOT** to generate a plot.
- Press **ENTER** to start the print/plot process.

2ndUNIT	>PRINT
PLOT	PC-DUMP

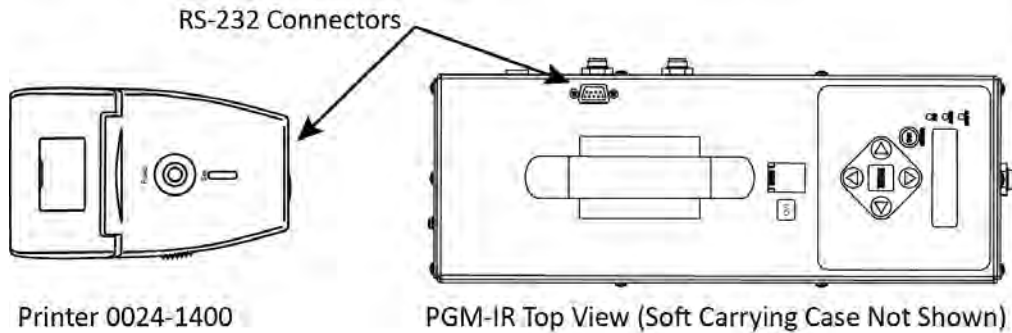

EXAMPLE PRINTOUT
Date / Time / PPM / Reading Number

LOG DATA			
DATE	TIME	PPM	
01/10/13	11:34	0PPM	0001 of 194
01/10/13	11:35	45PPM	0002 of 194
01/10/13	11:36	45PPM	0003 of 194
01/10/13	11:37	44PPM	0004 of 194
01/10/13	11:38	46PPM	0005 of 194
01/10/13	11:39	45PPM	0006 of 194
01/10/13	11:40	44PPM	0007 of 194
01/10/13	11:41	44PPM	0008 of 194
01/10/13	11:43	45PPM	0009 of 194
01/10/13	11:44	45PPM	0010 of 194
01/10/13	11:45	44PPM	0011 of 194
01/10/13	11:46	44PPM	0012 of 194
01/10/13	11:47	45PPM	0013 of 194
01/10/13	11:48	45PPM	0014 of 194
01/10/13	11:49	45PPM	0015 of 194
01/10/13	11:50	45PPM	0016 of 194
01/10/13	11:51	44PPM	0017 of 194
01/10/13	11:52	45PPM	0018 of 194
01/10/13	11:53	45PPM	0019 of 194
01/10/13	11:54	45PPM	0020 of 194
01/10/13	11:55	44PPM	0021 of 194
01/10/13	11:56	45PPM	0022 of 194
01/10/13	11:57	44PPM	0023 of 194
01/10/13	11:58	44PPM	0024 of 194
01/10/13	11:59	44PPM	0025 of 194
01/10/13	12:00	45PPM	0026 of 194
01/10/13	12:01	44PPM	0027 of 194
01/10/13	12:02	44PPM	0028 of 194
01/10/13	12:04	44PPM	0029 of 194
01/10/13	12:05	44PPM	0030 of 194
01/10/13	12:06	45PPM	0031 of 194
01/10/13	12:07	44PPM	0032 of 194
01/10/13	12:08	44PPM	0033 of 194

EXAMPLE PLOT
Date / Time / PPM Bar Graph

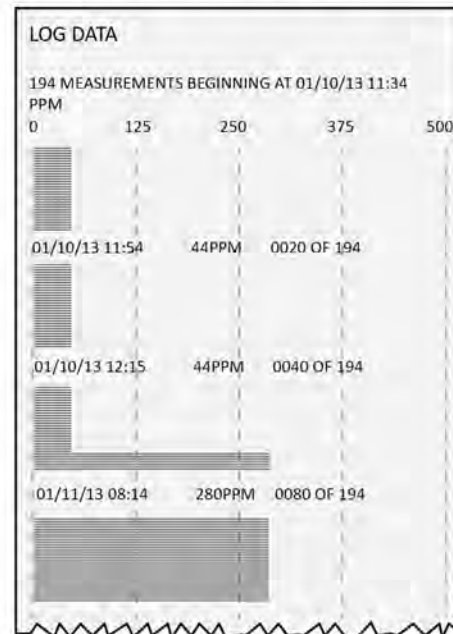

2.17 Downloading Stored Data to a Personal Computer

Using the monitor's **PC DUMP** feature, the last 200 gas readings that were stored in memory can be downloaded to a personal computer in ASCII text, comma-delimited format, which can then be imported into most spreadsheet programs for analysis.

The following describes how to download data to a computer using Windows® HyperTerminal as the communications program. If a different operating system and/or communications program is being used, then consult the appropriate instruction manuals for those products.

1. Install serial data cable P/N 104-4027 (straight through, 6 foot, DB9 male to DB9 female) between the computer's COM port and the analyzer's RS-232 connector. (For computers having a 25-pin COM port, use a 25-pin to 9-pin adapter or use a serial cable with appropriate connectors on each end.)
2. At the computer, start HyperTerminal by doing one of the following:

- If HyperTerminal has already been set up to communicate with the Refrigerant Monitor, then click **Start**, point to **Programs**, point to **Accessories**, point to **Communications**, click **HyperTerminal**, and double-click the file name or icon that has been associated with the monitor.
- If HyperTerminal has never been run in association with the monitor, then a new HyperTerminal connection needs to be made as follows:
 - a) Click **Start**; click **Run**. In the Run box, type “hypertrm.exe” and click **OK**. The **New Connection** dialog box should appear.
 - b) Type in a New Connection Name. Click **OK** to select the default icon (if desired, select a different icon before clicking OK). The “**Connect To**” dialog box should appear.
 - c) Click on **Connect from the** drop-down menu and choose the **COM** port to which the analyzer is connected. Then click **OK** to display the **COM Properties** dialog box for that COM port.
 - d) Set Port Settings to:
 - Bits per second: 19200
 - Data bits: 8
 - Parity: None
 - Stop bits: 1
 - Flow control: None

Then click **OK** to display HyperTerminal’s main window.
 - e) Click File; click Save. This creates a file with an .ht extension in the folder C:\Program Files\Accessories\Hyper Terminal, using the name that was entered in Step b.
- 3. After HyperTerminal is running: click **Transfer**, click **Capture Text**, and then click **Start** to accept the default drive\directory\filename to which all received data will be stored as an ASCII text file.



NOTE: By default, the captured text file will be stored on the hard drive at C:\Program Files\Accessories\HyperTerminal\CAPTURE.TXT. If desired, click **Browse** to select a different drive, directory and filename. The next time data is captured, it will be stored under the same location and filename.



NOTE: Changing the filename extension to “CSV” (comma separated variable) will allow the file to be directly opened in the spreadsheet program. For example, double clicking the filename CAPTURE.CSV in Windows Explorer will automatically start Microsoft Excel and load the file.

4. From the **Data Display** screen, press both the **Keypad Left** and **Right** buttons at the same time to display the first **Function Menu** screen. Next, use the **Keypad** buttons to move the arrow (>) until it points to **PC-DUMP**, and then press the **ENTER** button to begin the download process.

2ndUNIT	PRINT
PLOT	>PC-DUMP

5. Observe that the monitor’s screen goes blank and that HyperTerminal displays the data as it is being received. After all data has been transmitted, the Refrigerant Monitor re-displays the **Function Menu** screen.
6. To stop capturing data and save it, click **Transfer**, click **Capture Text**, click **Stop**.
7. HyperTerminal and the connection to the monitor can now be closed.

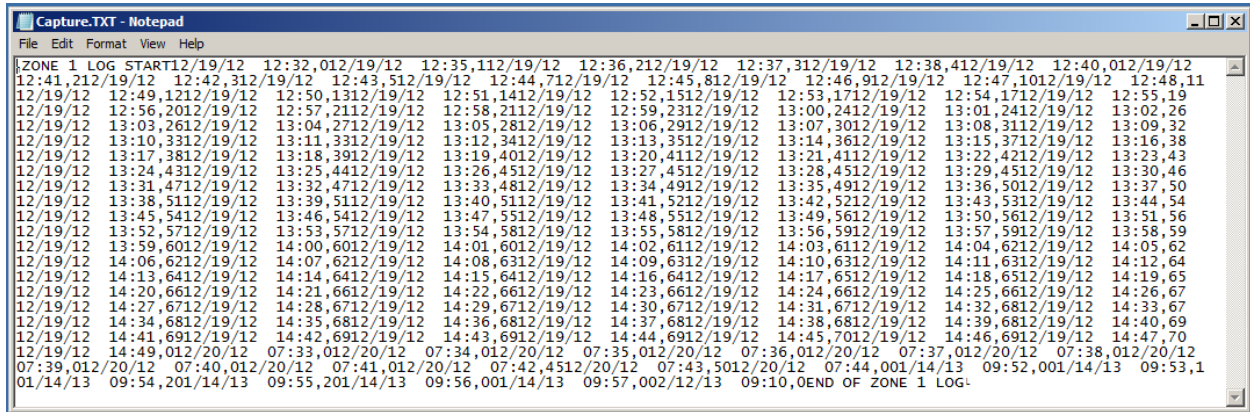

2.18 Importing Saved Data to a Spreadsheet

A text file that was created as described in Section 2.17 can be imported into spreadsheet programs that are capable of importing comma-delimited files.

The following describes how to generate a spreadsheet from a comma-delimited text file using Microsoft Excel. If you are using a different spreadsheet program or a different version of Excel, please refer to its instruction manual for information on how to import comma-delimited text files.

Step	Instructions	
1.	Start Microsoft Excel.	
2.	For Excel version 2003: Click Data, Import External Data, and Import Data to display the "Select Data Source" dialog box.	For Excel versions 2007-2013: Click the DATA tab, then click the FROM TEXT button. The IMPORT TEXT FILE dialog box is displayed.
3.	Locate file saved earlier.	
4.	For Excel version 2003: Select file, then click "Open" to display Excel's "Text Import Wizard."	For Excel versions 2007-2013: Select file, then click the "IMPORT" button.
5.	Choose the "Delimited" data option and click Next.	
6.	Check the "Tab," "Comma," and "Space" delimiters and click Finish.	
7.	Choose "Existing worksheet" or "New worksheet" and click OK to create spreadsheet.	



NOTE: A worksheet must be open in order to import data.

A sample spreadsheet is shown below.

	A	B	C	D
1	ZONE	1	LOG	START
2	12/19/2012	12:32	0	
3	12/19/2012	12:35	1	
4	12/19/2012	12:36	2	
5	12/19/2012	12:37	3	
6	12/19/2012	12:38	4	
7	12/19/2012	12:40	0	
8	12/19/2012	12:41	2	
9	12/19/2012	12:42	3	
10	12/19/2012	12:43	5	
11	12/19/2012	12:44	7	
12	12/19/2012	12:45	8	
13	12/19/2012	12:46	9	
14	12/19/2012	12:47	10	
15	12/19/2012	12:48	11	
16	12/19/2012	12:49	12	
17	12/19/2012	12:50	13	
18	12/19/2012	12:51	14	
19	12/19/2012	12:52	15	
20	12/19/2012	12:53	17	
21	12/19/2012	12:54	17	
22	12/19/2012	12:55	19	
23	12/19/2012	12:56	20	
24	12/19/2012	12:57	21	

: : : :

145	12/20/2012	7:42	45	
146	12/20/2012	7:43	50	
147	12/20/2012	7:44	0	
148	1/14/2013	9:52	0	
149	1/14/2013	9:53	1	
150	1/14/2013	9:54	2	
151	1/14/2013	9:55	2	
152	1/14/2013	9:56	0	
153	1/14/2013	9:57	0	
154	END	OF	ZONE	1
155	L			

3 Maintenance

3.1 Disassembly

When servicing the parts inside the HM unit, disassemble the monitor's metal chassis as follows:

Items Required:

- Medium Phillips head screwdriver

Procedure:

1. Remove monitor and its battery pack from the soft carrying case.
2. Unplug battery pack from monitor.
3. Remove a total of 10 screws from the locations shown in the illustrations below.
4. Carefully separate the metal chassis.

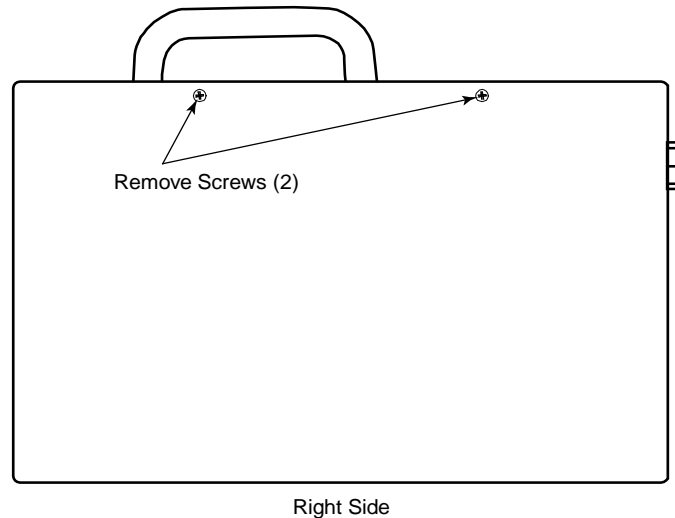
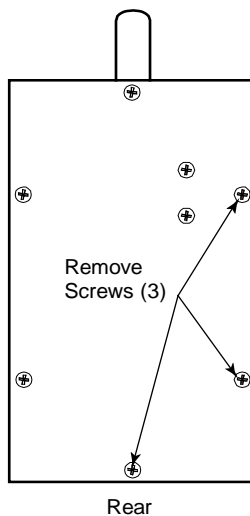
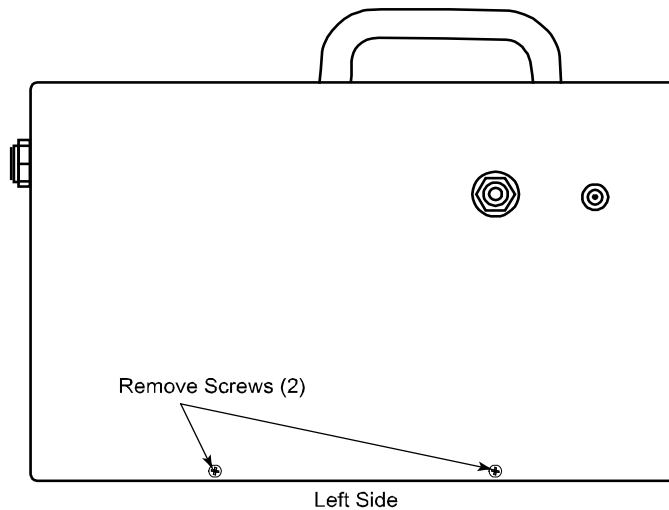
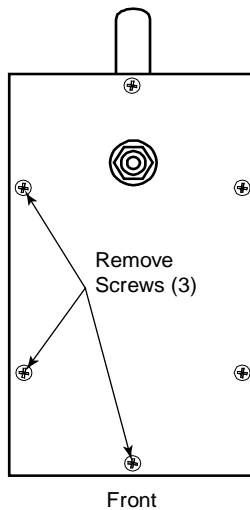

3.2 Internal Particulate/Hydrophobic Filter Replacement

Items Required:

- Replacement filter (P/N 0007-1654)
- Medium Phillips head screwdriver

Procedure:

1. Disassemble the monitor's metal chassis per Section 3.1.
2. See illustration below and locate the internal particulate / hydrophobic filter to be replaced.
3. Pull off tubing from both ends of filter and remove filter from instrument.
4. Attach tubing to new filter
5. Reassemble monitor.

Particulate/Hydrophobic Filter

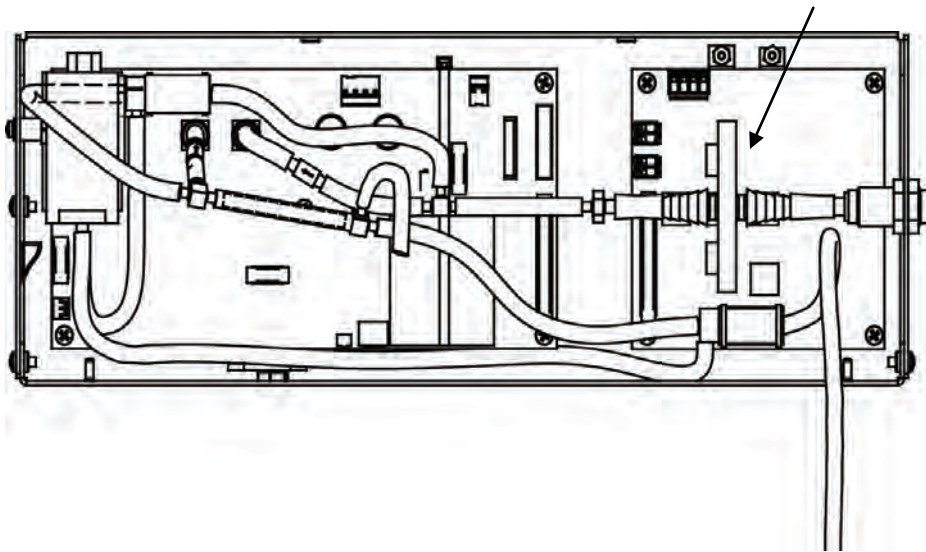

3.3 Updating Firmware

An RS-232 connector, located on the top panel, is used to update the monitor's firmware. Reprogramming the instrument with updated firmware should be done by qualified service technicians only using instructions provided by Bacharach.

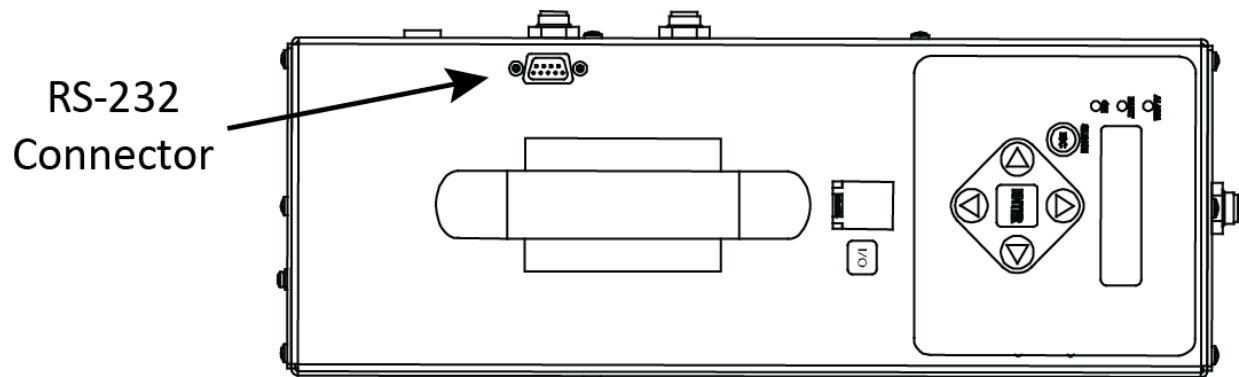

4 Parts and Service

4.1 Replacement Parts

Item Description	Part Number
Replacement Battery Kit	3015-5743
Replacement Battery Charger (for 87 Wh battery 3015-5743)	3015-5847
Replacement Cable (connects battery to PGM-IR)	3015-5757
Soft Carrying Case with Shoulder Strap	3015-5700
Bladder Bag Kit	3015-5325
Stainless Steel Probe	3015-5326
External Filter (fits onto probe tip)	3015-2906
Hydrophobic Filter (internal)	0007-1654
External Filter Assembly	3015-5324
Probe Tubing (3 ft)	0003-6182
Replacement Pump	3015-4239
Battery (for main PCB board)	0204-0020
Replacement Bench Kit	3015-4721
Replacement Power Cord (AUS)	0304-3469
Replacement Power Cord (UK)	0304-3471
Replacement Power Cord (EU)	0304-3470
Replacement Power Cord (US)	0304-3466

4.2 Optional Accessories

Item Description	Part Number
IrDA Printer (includes printer, roll of thermal paper, 4 x AA batteries, manual)	0024-1400
Thermal printer paper, 1 roll	0006-8733
Thermal printer paper, 5 rolls	0024-1310
Cable (DB9 to RJ-45)	3015-4214
Computer Communications Cable (DB9 male to DB9 female)	0104-4027

4.3 Service Centers

Service and replacement parts can be obtained by contacting the Bacharach Service Centers listed below. Access <http://mybacharach.com/rmaform/> on the web for return materials authorization.

United States

Bacharach, Inc.
621 Hunt Valley Circle
New Kensington, PA 15068
USA
Phone: 724-334-5051
Fax: 724-334-5723

Ireland

Bacharach - Europe
114A Georges Street Lower
Dun Laoghaire, Dublin
Ireland
Phone: +353 1 284 6388
Fax: +353 1 284 6389

Canada

Bacharach - Canada
20 Amber St. Unit #7
Markham, Ontario L3R SP4
Canada
Phone: 905-470-8985
Fax: 905-470-8963



CE Declaration of Conformity

Product(s):	Leak Detector
Model(s):	PGM-IR and derivatives
The manufacturer of the products covered by this declaration:	Bacharach, Inc. 621 Hunt Valley Circle New Kensington, PA 15068 U.S.A.
Year(s) conformity is declared:	2015
Directive(s)	2014/30/EU Electromagnetic Compatibility (EMC)

This declaration of conformity is issued under the sole responsibility of the manufacturer.

Object of the declaration	
----------------------------------	---

The object of the declaration described above is in conformity with the relevant Union harmonisation legislation.

Harmonised Standard(s)

EN 61326-1:2013	Electrical equipment for measurement, control and laboratory use - EMC requirements - Part 1: General requirements
-----------------	--

Signed for and on behalf of Bacharach, Inc.

New Kensington, PA, U.S.A., 07 March 2016

Aaron E. Kennison, Engineering Manager



The technical documentation file required by this directive is maintained at the corporate headquarters of Bacharach, Inc.

NOTE: The Directives or Harmonized Standards to which this product has been evaluated **may have** changed. Bacharach, Inc. however continues to market this product under a presumption of conformity even though the Standards **may** no longer be harmonized.