

FLUKE®

345
Power Quality Clamp Meter

Users Manual

PN 2560401
October 2006
© 2006 Fluke Corporation, All rights reserved. Printed in China
Product names are trademarks of their respective companies.

LIMITED WARRANTY AND LIMITATION OF LIABILITY

Each Fluke product is warranted to be free from defects in material and workmanship under normal use and service. The warranty period is one year and begins on the date of shipment. Parts, product repairs, and services are warranted for 90 days. This warranty extends only to the original buyer or end-user customer of a Fluke authorized reseller, and does not apply to fuses, disposable batteries, or to any product which, in Fluke's opinion, has been misused, altered, neglected, contaminated, or damaged by accident or abnormal conditions of operation or handling. Fluke warrants that software will operate substantially in accordance with its functional specifications for 90 days and that it has been properly recorded on non-defective media. Fluke does not warrant that software will be error free or operate without interruption.

Fluke authorized resellers shall extend this warranty on new and unused products to end-user customers only but have no authority to extend a greater or different warranty on behalf of Fluke. Warranty support is available only if product is purchased through a Fluke authorized sales outlet or Buyer has paid the applicable international price. Fluke reserves the right to invoice Buyer for importation costs of repair/replacement parts when product purchased in one country is submitted for repair in another country.

Fluke's warranty obligation is limited, at Fluke's option, to refund of the purchase price, free of charge repair, or replacement of a defective product which is returned to a Fluke authorized service center within the warranty period.



To obtain warranty service, contact your nearest Fluke authorized service center to obtain return authorization information, then send the product to that service center, with a description of the difficulty, postage and insurance prepaid (FOB Destination). Fluke assumes no risk for damage in transit. Following warranty repair, the product will be returned to Buyer, transportation prepaid (FOB Destination). If Fluke determines that failure was caused by neglect, misuse, contamination, alteration, accident, or abnormal condition of operation or handling, including overvoltage failures caused by use outside the product's specified rating, or normal wear and tear of mechanical components, Fluke will provide an estimate of repair costs and obtain authorization before commencing the work. Following repair, the product will be returned to the Buyer transportation prepaid and the Buyer will be billed for the repair and return transportation charges (FOB Shipping Point).

THIS WARRANTY IS BUYER'S SOLE AND EXCLUSIVE REMEDY AND IS IN LIEU OF ALL OTHER WARRANTIES, EXPRESS OR IMPLIED, INCLUDING BUT NOT LIMITED TO ANY IMPLIED WARRANTY OF MERCHANTABILITY OR FITNESS FOR A PARTICULAR PURPOSE. FLUKE SHALL NOT BE LIABLE FOR ANY SPECIAL, INDIRECT, INCIDENTAL, OR CONSEQUENTIAL DAMAGES OR LOSSES, INCLUDING LOSS OF DATA, ARISING FROM ANY CAUSE OR THEORY.

Since some countries or states do not allow limitation of the term of an implied warranty, or exclusion or limitation of incidental or consequential damages, the limitations and exclusions of this warranty may not apply to every buyer. If any provision of this Warranty is held invalid or unenforceable by a court or other decision-maker of competent jurisdiction, such holding will not affect the validity or enforceability of any other provision.

Table of Contents

Title	Page
Introduction	1
Symbols	1
Safety Instructions	2
Specifications.....	4
Electrical Data	4
General Data	11
Qualified Personnel.....	12
Safe Operation	12
Proper Usage.....	12
Warranty	13
Electrical Connections	13
Accessories	13
Risks During Clamp Meter Operation	13
Device Shutdown.....	14
Maintenance and Repairs.....	14
Measuring Inputs and Power Adapter.....	15
Voltage Measuring Input	15
Power Adapter and USB Connection.....	15
Design and Functions.....	16
Front View	17
Rear and Side View	18
Using the Clamp Meter.....	19
Check the Shipment	19
Preparing Clamp Meter for Use	19
Initial Setup.....	19
Switching the Clamp Meter On.....	20
Switching the Device Off.....	21
Connection to Circuits	21
Connecting Sequence.....	21
Overview.....	22
Voltage and Current Measurements.....	22
Single Phase Power Measurement Connection	24
Balanced Three-Phase Power Measurement Connection	25
Configuration.....	26
Operating Controls and Display.....	26

Display Symbols	27
Navigation and Measuring Keys	28
Navigation through the Display.....	28
Measurement Setup.....	29
Basic Adjustments Required before Measuring	29
Voltage Range Settings	30
Current Range Settings.....	31
Additional Instrument Settings.....	31
Measurements	33
Measurement Tips	33
Displaying Measurements	33
Saving Measurement Screens.....	34
Viewing Saved Screens	35
Logging Tips	36
Measurement Function Overview	42
Voltage Measurements	42
Current Measurement	45
 Waveforms	45
 Harmonics	47
Harmonic Recording	51
W Power	54
W3Φ Three-Phase Power.....	57
INRUSH Current	58
INRUSH Recording Playback	64

List of Tables

Table	Title	Page
1.	Symbols	1
2.	Navigation and Measuring Keys	28
3.	Voltage Measurements	43
4.	Current Measurements	45
5.	Waveforms Measurements.....	45
6.	Harmonics Measurements.....	48
7.	Power	54
8.	Three Phase Power.....	57

List of Figures

Figure	Title	Page
1.	Voltage Measuring Input	15
2.	Slider Switch for Line Power Voltage (115 V and 230 V)	15
3.	Power Adapter and USB Connection.....	16
4.	345 Front View	17
5.	Rear and Side View	18
6.	Battery Life Screen of Clamp Meter.....	20
7.	Voltage and Current Measurement Connections.....	23
8.	Single Phase Power Measurement Connection	24
9.	Three-Phase Power Connection.....	26
10.	Display Symbols of Clamp Meter.....	27
11.	Navigation through the Display	29
12.	Voltage Range Settings.....	30
13.	Current Range Settings	31
14.	Additional Instrument Settings Menu	32
15.	Additional Instrument Setting Items	33
16.	Detailed View of Harmonic Recording Display	53

345 Power Quality Clamp Meter











Introduction

The Fluke 345 Power Quality Clamp Meter, referred throughout this document simply as the “Clamp Meter”, is a rugged, accurate, professional power industry tool for measuring current, voltage, and power quality.

Symbols

Table 1 lists the symbols used on the instrument and/or in this manual.

Table 1. Symbols

Symbol	Description
	Hazardous voltage. Risk of electrical shock.
	Important information. Risk of danger. See manual
	Earth ground
	Do not dispose of this product as municipal waste. Contact Fluke or a qualified recycler for disposal
	Double insulated.
	Low battery when shown on display.
	DC (Direct Current).
CAT	IEC 61010 Measurement (installation) Category .
	Conforms to requirements of European Union and European Free Trade Association (EFTA).
	Canadian Standards Association.
	Conforms to relevant Australian standards.

Safety Instructions

Please read this section carefully. It will familiarize you with important safety instructions for handling your Clamp Meter. In this manual a **Warning** identifies conditions and actions that pose hazard(s) to the user. A **Caution** identifies conditions and actions that may damage the test instrument.

The design and manufacture of the device conforms to the latest state of technology and the safety standards specified in IEC 61010-1/ 2nd edition. If used improperly, there is a risk of damage to persons and property.

⚠ ⚠ Warning

Review the entire manual before using the Clamp Meter and its accessories. To avoid electrical shock or fire:

- **Use the Meter only as specified in this manual or the protection provided by the Meter might be impaired.**
- **Use caution when working with voltages above 33 V acrms, 46.7 V ac peak, or 70 V dc. These voltages pose ashock hazard.**
- **When using probes, keep your fingers behind the finger guards.**
- **Replace the battery as soon as the low battery**
- **indicator (B) appears to avoid false readings that can lead to electric shock and injury.**
- **Adhere to local and national safety codes. Individual protective equipment must be used to prevent shock and arc blast injury where hazardous live conductors are exposed.**
- **Do not hold the Current Probe anywhere beyond the tactile barrier, see Figure 4.**

Power Quality Clamp Meter
Safety Instructions

- Before use, inspect the Clamp Meter, voltage probes, test leads, and accessories for mechanical damage, and replace if damaged. Look for cracks or missing plastic. Pay special attention to the insulation surrounding the connectors.
- Avoid working alone when working with live circuits.
- Use only insulated test leads and adapters as supplied with the Clamp Meter, or indicated as suitable for the Fluke 345 Clamp Meter.
- Always connect the Battery Charger/Power Adapter first to the ac outlet before connecting it to the Clamp Meter.
- Remove all probes, test leads and accessories not in use.
- Do not operate the Clamp Meter around explosive gas or vapor.
- Do not exceed Clamp Meter input voltage or current ratings.
- Do not use exposed metal BNC or banana plug connectors or insert metal objects into connectors.

⚠ Caution

Do not open the Clamp Meter for cleaning. Do not use solvents to clean it, and do not immerse it in liquid.

Only trained personnel should perform maintenance work. Any such work undertaken by unauthorized personnel may damage the Clamp Meter and will invalidate the warranty.

Specifications

Electrical Data

All accuracies specified at 23 °C ± 1 °C
Temperature coefficient of current ≤ ±0.15 % of rdg per °C
Temperature coefficient of voltage ≤ ±0.15 % of rdg per °C

Current Measurement (DC, DC RMS, AC RMS)

Measuring range..... 0 – 2000 A dc, 1400 ac rms
Autorange facility 40 A / 400 A / 2000 A
Resolution..... 10 mA in 40 A range
100 mA in 400 A range
1 A in 2000 A range

Accuracy

RMS and DC

I > 10 A ± 1.5 % rdg ± 5 digits
I < 10 A ± 0.2 A

AVE

I > 10 A ± 3 % rdg ± 5 digits
I < 10 A ± 0.5 A

Pk

I > 10 A ± 5 % rdg ± 5 digits
I < 10 A ± 0.5 A

AHr

I > 10 AHr ± 2 % rdg ± 5 digits
I < 10 AHr ± 0.5 AHr

CF (Crest Factor)

1.1 ≤ CF < 3 ± 3 % rdg ± 5 digits
3 ≤ CF < 5 ± 5 % rdg ± 5 digits
Resolution..... 0.01

RPL (Ripple)

2 % ≤ RPL < 100 % ± 3 % rdg ± 5 digits
100 % ≤ RPL < 600 % ± 5 % rdg ± 5 digits
Resolution..... 0.1 %

I_{DC} > 5 A, I_{AC} > 2 A

All measurements DC and 15 Hz to 1 kHz.

Maximum overload 10,000 A or rms x frequency < 400,000.

Amps rms is a true rms measurement (ac + dc)

**Power Quality Clamp Meter
Specifications**

Harmonics

THD (Total Harmonic Distortion)

1 % ≤ THD 1 % to 100 %:.....	± 3 % rdg ± 5 digits
100 % to 600 %:	± 5 % rdg ± 5 digits
Resolution.....	0.1 %

DF (Distortion Factor)

1 % ≤ DF < 100 %	± 3 % rdg ± 5 digits
Resolution.....	0.1 %
H02 ≤ I _{harm} < H13.....	± 5 % rdg ± 2 digits
H13 ≤ I _{harm} ≤ H30.....	± 10 % rdg ± 2 digits

All measurements up to 30th harmonic (40th harmonic for 15 Hz to 22 Hz)

Frequency range of fundamental F₀ 15 Hz to 22 Hz and 45 Hz to 65 Hz

I_{acms} > 10 A

Voltage Measurement (DC, DCRMS, ACRMS)

Measuring range.....	0 – 825 V dc or ac rms
Autorange facility	4V / 40V / 400V / 750V
Resolution.....	1 mV in 4 V range 10 mV in 40 V range 100 mV in 400 V range 1 V in 750 V range

Accuracy

RMS and DC

V > 1 V.....	± 1 % rdg ± 5 digits
V < 1 V.....	± 0.02 V

AV

V > 1 V.....	± 3 % rdg ± 5 digits
V < 1 V.....	± 0.03 V

Pk

V > 1 V.....	± 5 % rdg ± 5 digits
V < 1 V.....	± 0.03 V

CF (Crest Factor)

1.1 ≤ CF < 3.....	± 3 % rdg ± 5 digits
3 ≤ CF < 5.....	± 5 % rdg ± 5 digits
Resolution.....	0.01

RPL (Ripple)

2 % ≤ RPL < 100 %	± 3 % rdg ± 5 digits
100 % ≤ RPL < 600 %	± 5 % rdg ± 5 digits
Resolution.....	0.1 %

V_{DC} > 0.5 V, V_{AC} > 0.2 V

All measurements DC and 15 Hz to 1 kHz.

Maximum overload 825 V rms

Volts rms is a true rms measurement (ac + dc)

Harmonics

THD (Total Harmonic Distortion)

1 % ≤ THD < 100 % ± 3 % rdg ± 5 digits

100 % ≤ THD < 600 % ± 5 % rdg ± 5 digits

Resolution 0.1 %

DF (Distortion Factor)

1 % ≤ DF < 100 % ± 3 % rdg ± 5 digits

Resolution 0.1 %

H02 ≤ V_{harm} < H13 ± 5 % rdg ± 2 digitsH13 ≤ V_{harm} ≤ H30 ± 10 % rdg ± 2 digitsAll measurements up to 30th harmonic (40th harmonic for 15 Hz to 22 Hz)Frequency range of fundamental F₀ 15 Hz to 22 Hz and 45 Hz to 65 HzV_{acrms} > 1V**Watts Measurement (Single and 3 Phase) (DC, DC RMS, AC RMS)**

Measuring range 0 – 1650 kW dc or 1200 kW ac

Autoranging facility 4 kW, 40 kW, 400 kW, 1650 kW

Resolution 1 W in 4 kW

10 W in 40 kW

100 W in 400 kW

1 kW in 1650 kW

Accuracy 2.5 % rdg ± 5 digits

W1Ø < 2 kW ± 0.08 kW

W3Ø < 4 kW ± 0.25 kW

VA Measurement (Single and 3 Phase) (DC, DC RMS, AC RMS)

Measuring range 0 to 1650 kVA dc or 1200 kVA ac

Autorange facility 4 kVA, 40 kVA, 400 kVA, 1650 kVA

Resolution 1 VA in 4 kVA

10 VA in 40 kVA

100 VA in 400 kVA

1 kVA in 1650 kVA

Accuracy

VA > 2 kVA 2.5 % rdg ± 5 digits

VA < 2 kVA ± 0.08 kVA

**Power Quality Clamp Meter
Specifications**

VAR Measurement (Single and 3 Phase)

Measuring range.....	0 – 1200 kVAR
Autorange facility	4 kVAR, 40 kVAR, 400 kVAR, 1200 kVAR
Resolution	1 VAR in 4 kVAR range 10 VAR in 40 kVAR range 100 VAR in 400 kVAR range 1 kVAR in 1200 kVAR range
Accuracy	
VAR > 4 kVAR	± 2.5 % rdg ± 5 digits
VAR < 4 kVAR	± 0.25 kVAR
Power Factor range	0.3 < PF < 0.99

Power Factor (Single and 3 Phase)

Power Factor	
Measuring range	0.3 cap ... 1.0 ... 0.3 ind (72.5° capacitive ... 0° ... 72.5° inductive)
Resolution	0.001
Accuracy	± 3 °
Frequency range	15 Hz to 1 kHz
Displacement Power Factor	
Measuring range	0.3 cap ... 1.0 ... 0.3 ind (72.5 ° capacitive ... 0° ... 72.5 ° inductive)
Resolution	0.001
Accuracy	± 3 °
Frequency ranges	15 Hz to 22 Hz and 45 Hz to 65 Hz

Kilowatt Hour (kWhr)

Measuring range.....	40,000 kWhr
Autorange facility	4 kWhr, 40 kWhr, 400 kWhr, 4,000 kWhr, 40,000 kWhr
Resolution	1 WHr in 4 kWhr range 10 WHr in 40 kWhr range 100 WHr in 400 kWhr range 1 kWhr in 4,000 kWhr range 10 kWhr in 40,000 kWhr range

Accuracy

kWhr > 2 kWhr $\pm 3\% \pm 5$ digitskWhr < 2 kWhr ± 0.08 kWhr

All Watts /VA /VAR /PF measurements

Frequency range DC and 15 Hz to 1 kHz

Current range 10 A to 1400 A rms

Voltage range 1 V to 825 V rms

Maximum input 825 V rms / 1400 A rms

Maximum overload 825 V rms / 10,000 A All
measurements DC and 15 Hz to 1
kHz. Maximum overload 10,000 A or
rms x frequency < 400,000.**Frequency Measurement** (From Current or Voltage sources)

Measuring range 15 Hz to 1 kHz

Resolution 0.1 Hz

Accuracy

15 to 22 Hz $\pm 0.5\%$ rdg40 to 70 Hz $\pm 0.5\%$ rdg15 to 1000 Hz $\pm 1\%$ rdg

Current Range 10 A to 1400 A rms

Voltage Range 1 V to 825 V rms

Scope Function

Current measurement

Ranges 10 A/20 A/40 A/100 A/200 A/400
A/1000 A/2000 AResolution 1 A in 40 A range
10 A in 400 A range
50 A in 2000 A rangeAccuracy $\pm 3\%$ rdg ± 1 pixel

Maximum overload 10,000 A

Voltage measurement

Ranges 4 V/10 V/20 V/40 V/100 V/200 V/400
V/1000 VResolution 100 mV in 4 V range
1 V in 40 V range
10 V in 400 V range
31.25 V in 1000 V rangeAccuracy $\pm 2\%$ rdg ± 1 pixel

Maximum overload 1000 V rms

Frequency range DC and 15 Hz to 600 Hz

Time base 2.5 ms, 5 ms, 10 ms, 25 ms, 50 ms/div

Refresh rate 0.5 seconds

Sampling rate 15.625 kHz

**Power Quality Clamp Meter
Specifications**

Inrush Current Function

Ranges	40, 400 and 2000 A
Resolution	10 mA in 40 A range 100 mA in 400 A range 1 A in 2000 A range
Accuracy	
I > 10 A	± 5 % rdg ± 1 pixel
I < 10 A	± 0.5 A
All measurements DC and 15 Hz to 1 kHz	
Maximum overload	10,000 A or rms x frequency < 400,000.
Amps rms is a true rms measurement (AC + DC)	
Capture time	1, 3, 10, 30, 100 and 300 s
Sampling rate.....	15.625 kHz

Digital Output

- USB Interface to a PC
- Power Log software for download, analysis and reporting
- 345 Upgrade Utility for installing a new firmware version

Logging Memory

Logging Areas.....	Three areas that can be used individually or combined into one large area.
Averaging periods.....	1 s, 2 s, 5 s, 10 s, 30 s, 1 min, 5 min, 10 min, 15 min, and custom

Logging Times:

Volts and Current Mode		
Average Time	Logging Time (1 area)	Logging Time (3 areas)
1 s	1 h 49 m	5 h 12 m
2 s	3 h 38 m	10 h 24 m
5 s	9 h 06 m	1 d 2 h 00 m
10 s	18 h 12 m	2 d 04 h 00 m
30 s	2 d 06 h 36 m	6 d 12 h 01 m
1 min	4 d 13 h 12 m	13 d 00 h 03 m
5 min	22 d 18 h 00 m	65 d 00 h 15 m
10 min	45 d 12 h 00 m	130 d 00 h 30 m
15 min	68 d 06 h 00 m	195 d 00 h 45 m

V & A Harmonics Mode		
Average Time	Logging Time (1 area)	Logging Time (3 areas)
1 s	0 h 34 m	1 h 38 m
2 s	1 h 08 m	3 h 16 m
5 s	2 h 52 m	08 h 11 m
10 s	5 h 44 m	16 h 23 m
30 s	17 h 13 m	2 d 01 h 11 m
1 min	1 d 10 h 26 m	4 d 02 h 23m
5 min	7 d 04 h 10 m	20 d 11 h 25m
10 min	14 d 08 h 20 m	81 d 0 h 50m
15 min	21 d 12 h 30 m	121 d 13 h 15m

Single and Three Phase Power Mode		
Average Time	Logging Time (1 area)	Logging Time (3 areas)
1 s	1 h 40 m	4 h 47 m
2 s	3 h 21 m	9 h 34 m
5 s	8 h 22 m	23 h 57 m
10 s	16 h 45 m	1 d 23 h 54 m
30 s	2 d 02 h 17 m	5 d 23 h 42 m
1 min	4 d 04 h 35 m	11 d 23 h 25 m
5 min	20 d 22 h 55 m	59 d 21 h 05 m
10 min	41 d 21 h 50 m	119 d 18 h 10 m
15 min	62 d 20 h 45 m	179 d 15 h 15 m

**Power Quality Clamp Meter
Specifications**

General Data

Display

Color transmissive LCD 320 x 240 pixels (70 mm diagonal) with 2 level backlight.

Power Supply

Battery type 1.5 V Alkaline AA NEDA 15A or IEC LR6 x 6

Battery life typically:

- >10 hours (backlight on full)
- >12 hours (backlight reduced)

Battery Eliminator BE345

- Input..... 110V / 230V, 50/60 Hz
- Output 15 V dc, 300 mA

Environmental (FOR INDOOR USE ONLY)

Reference conditions. All accuracies stated at 23 °C ± 1 °C

Operating temperature..... 0°C to 50°C (32°F to 122°F)

Temperature coeff. of current ≤ ±0.15 % of rdg per °C

Temperature coeff. of voltage ≤ ±0.15 % of rdg per °C

Maximum relative humidity 80 % for temperatures up to 31 °C
(87 °F) decreasing linearly to 50 %
relative humidity at 40 °C (104 °F)

Maximum operating altitude 2000 m

Electrical Safety

Safety EN / IEC 61010-1 and IEC61010-2-032 600 V CAT IV, 1000V CAT III
(maximum input phase-phase 825V rms) double or reinforced insulation, pollution
degree 2

Protection IP 40; EN / IEC 60529

Maximum working voltage in CAT IV areas:

Current measurement: 600 V ac rms or dc between conductor
& ground

Voltage measurement..... 600 V ac rms or dc between either input
terminal and ground, or 825 V between
energized phase voltages (delta power
config.)

Maximum working voltage in CAT III areas 825V ac rms or dc between either input
terminal and ground

EMC

Emission IEC/EN 61326-1:1997 class B

Immunity IEC/EN 61326-1:1997

Mechanical

Dimensions

Length 300 mm (12 inches)

Width 98 mm (3.75 inches)

Depth 52 mm (2 inches)

Weight including batteries..... 820 g / 1.8 lbs.

Jaw opening..... 60 mm

Jaw capacity 58 mm diameter

Qualified Personnel

Adequate personnel qualifications are the following:

- Trained and authorized to switch on/off, earth ground, and mark power distribution circuits and devices in accordance with the safety standards of electrical engineering.
- Training or instruction in accordance with the standards of the safety engineering in maintenance and use of appropriate safety equipment.
- Training in first aid.

Safe Operation

For safe operation of the Clamp Meter:

- Ensure that anyone using the device has read and fully understood the operating manual and safety instructions.
- The device may only be used under certain ambient conditions. Ensure that the actual ambient conditions conform to the admissible conditions detailed in “Technical Information” section.

Proper Usage

Before use, inspect the test leads for mechanical damage and replace damaged test leads. If the Clamp Meter or its accessories appear to be impaired or not functioning properly, discontinue using and send for repair.

If the Clamp Meter is used in a manner not specified by the manufacturer, the protection provided by the Clamp Meter may be impaired.

Note

To accommodate connection to various line power sockets, the BE345 Battery Charger/Power Adapter is equipped with a male plug that must be connected to a line plug adapter appropriate for local use. Since the Charger is isolated, you can use line plug adapters with or without a protective ground terminal.

The 230 V rating of the BE345 is not for use in North America. A line plug adapter complying with the applicable country-specific requirements may be provided to alter the blade configuration.

Power Quality Clamp Meter Warranty

Do not use the device for any purpose other than measuring of voltages and currents that are within the measuring ranges and categories, including voltage to earth ground, as specified in “Technical Information” section.

Improper use of the device shall void the warranty.

Warranty

The warranty period for fault free operation is limited to 1 year from the date of purchase. For more detailed warranty information for the Clamp Meter, refer to the front section of this manual.

Electrical Connections

- Ensure that the power and connecting cables used with the device are in proper working order.
- Ensure that the power and connecting cables, as well as all accessories used in conjunction with the Clamp Meter, are in proper working order and clean.
- Install the Clamp Meter in such a way that its power cable is accessible at all times and can easily be disconnected.

Accessories

- Use only the accessories supplied with the device or specifically available as optional equipment for your model.
- Ensure that any third-party accessories used in conjunction with the device conform to the IEC 61010-2-031/-032 standard.

Risks During Clamp Meter Operation

- For connection work, do not work on your own but in teams of at least two persons.
- Do not use the device if the housing or an operating element is damaged.
- Ensure that the connected devices work properly.

Device Shutdown

- If you detect any damage to the housing, controls, power cable, connecting leads, or connected devices, immediately disconnect the unit from the power supply.
- If you are in doubt regarding the safe operation of the device, immediately shut down the Clamp Meter and the respective accessories, secure them against inadvertent switching on, and bring them to an authorized service agent.

Maintenance and Repairs

- Do not open the housing. Maintenance work should only be carried out by qualified service personnel.
- Do not repair or replace any component parts of the device.
- The only user-serviceable parts in the Clamp Meter are replacement alkaline cells. The device must be disconnected from all live voltages and currents before opening to replace these cells. Also, disconnect all test leads before using the USB interface.
- Damaged connecting leads and power leads must be repaired or replaced by an authorized service technician.
- Authorized, specialized technicians may only repair damaged or defective devices.

Measuring Inputs and Power Adapter

Voltage Measuring Input

The maximum input voltage for over-voltage category CAT IV may not exceed 600 V to earth ground (825 V line to line voltage).

Figure 1 shows the voltage measuring input of the Clamp Meter.

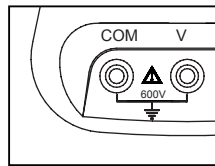

eln02.eps

Figure 1. Voltage Measuring Input

Note

- *Do not remove any covers other than the cover of the battery compartment.*
- *Refer all servicing to qualified personnel.*
- *The device may only be used indoors.*

Power Adapter and USB Connection

Line power voltage may be set with the slider switch on BE345 Battery Charger/Power Adapter to shown in Figure 2; settings are for 115 V or 230 V installations.

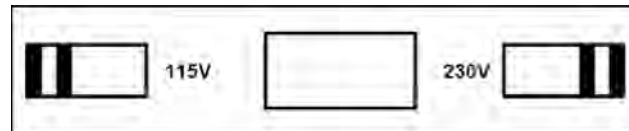

eln01.bmp

Figure 2. Slider Switch for Line Power Voltage (115 V and 230 V)

⚠ ⚠ Warning

- **Use only the power supply, Battery Charger/Power Adapter (Model BE345).**
- **Before use check that the selected voltage range indicated on the BE345 matches the local line power voltage and frequency (refer to Figure 2). If necessary, set the slider switch of the BE345 to the correct voltage.**
- **For the BE345, use only ac line plug adapters or ac line cords that comply with local safety regulations.**

The power (mains) source must conform to the following input ranges/values:

- Euro/UK adapter: 210...264 VAC, 47...53 Hz/ 8 VA
- US Adapter: 100...120 VAC, 57...63 Hz/ 8VA

Figure 3 shows the power adapter and USB ports for the Clamp Meter.

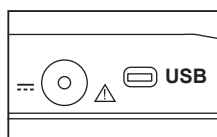

eln03.eps

Figure 3. Power Adapter and USB Connection

Voltage measuring inputs should be disconnected before attaching the USB cable to a PC. Saved data may be downloaded to a PC using the supplied USB cable; review saved data using the software included on the CD.

Design and Functions

This section provides an overview of the terminals, ports, and interfaces of the Clamp Meter, as well as a list of display and operating devices, and a brief introduction to the basic functions.

Front View

Figure 4 shows the front view of the 345 Power Quality Clamp Meter.

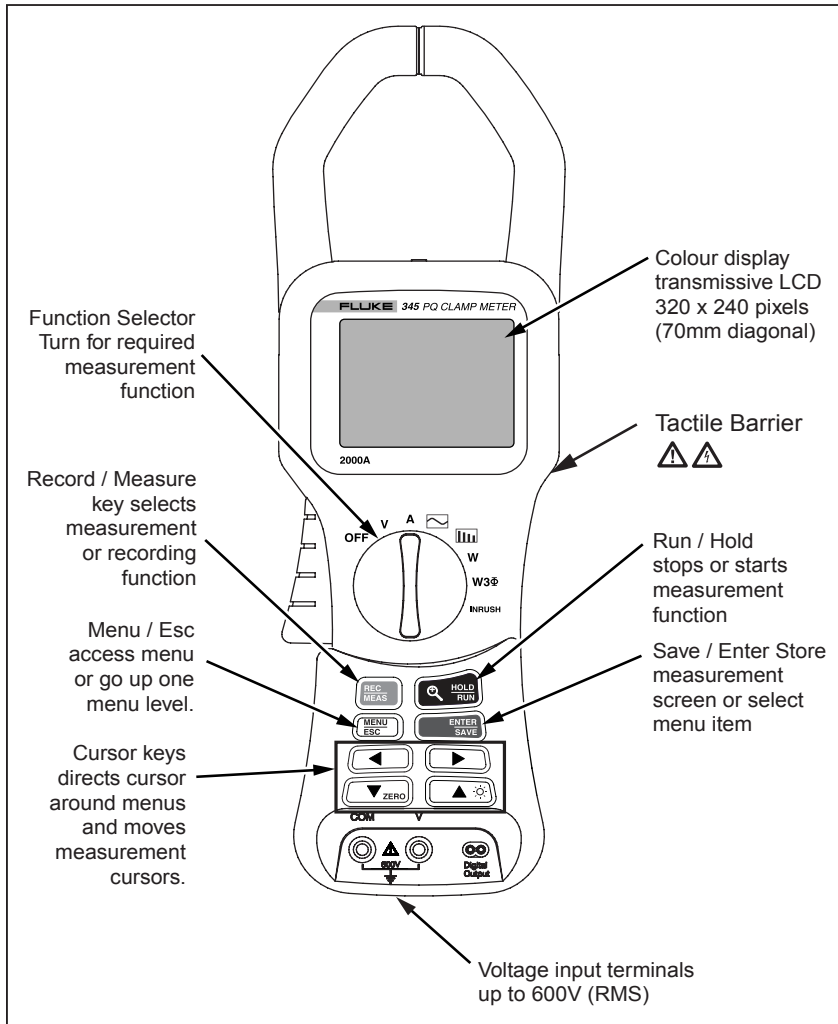

eln04.eps

Figure 4. 345 Front View

Rear and Side View

Figure 5 shows the rear and side view of the 345 Power Quality Clamp Meter.

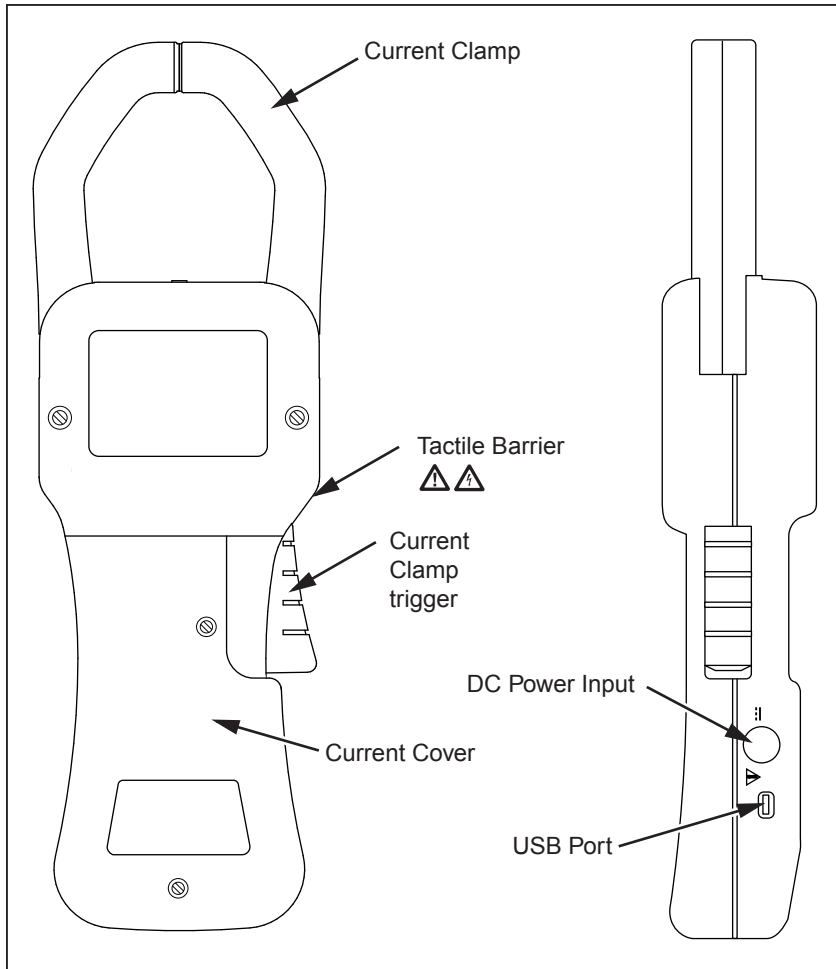

Figure 5. Rear and Side View

eln05.eps

Using the Clamp Meter

Check the Shipment

Before using the Clamp Meter for the first time, ensure the shipment is complete using the following list and the delivery specifications:

- 1 345 Power Quality Clamp Meter
- 1 Users Manual
- 1 Battery Charger/Power Adaptor (BE345)
- 1 set of voltage measuring leads
- 1 CD-ROM containing software
- 1 USB cable for connection to PC
- 1 carrying case

Preparing Clamp Meter for Use

Follow the safety instructions regarding ambient conditions and location of installation.

Initial Setup

⚠ ⚠ Warning

With the devices connected to the power mains, a number of internal components are live with dangerous voltage levels. Utilization of leads and accessories that do not meet relevant safety standards could lead to serious injury or death from electric shock.

The Clamp Meter is delivered with six AA cells installed in the instrument, and is ready for use.

A mains power adapter BE345 is also supplied. This universal power adaptor is delivered with a plug suitable for your country. The correct plug should be selected at the time of ordering or purchase from those available.

This BE345 adapter should be used to maintain power when logging measurements to the Clamp Meter's internal memory.

Note

The Clamp Meter operates from standard alkaline cells. The batteries are bypassed when the mains adaptor is plugged in to the Clamp Meter and a power source.

Rechargeable cells cannot be charged inside the instrument.

Switching the Clamp Meter On

To turn on the Clamp Meter:

1. Turn the central rotary selector to selected measurement position.
2. The device is now ready for operation.

Figure 6 displays the battery life screen following start-up.

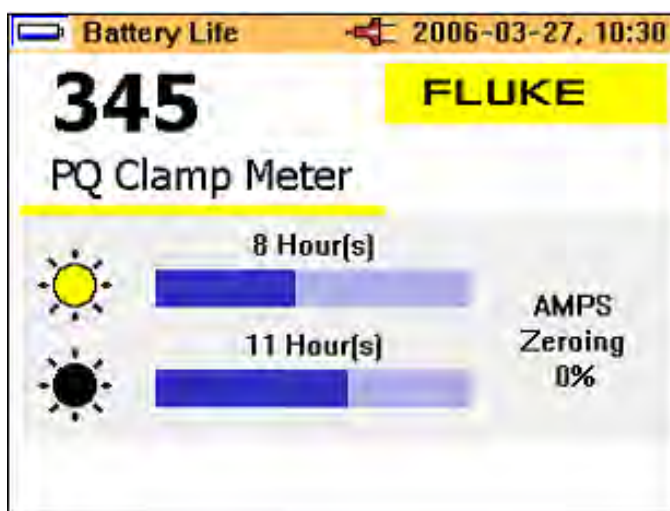

eIn06.bmp

Figure 6. Battery Life Screen of Clamp Meter

3. The instrument will auto zero the current measuring circuit during the start-up period, and the progress of the process is indicated on the display.

Switching the Device Off

To switch the device off:

1. Turn the rotary switch to the **OFF** position.
2. If the device is not to be used for a prolonged period of time, disconnect the power adaptor, and store the Clamp Meter and accessories in the supplied carrying case.

Connection to Circuits

⚠ ⚠ Warning

Prior to connecting the circuits, ensure that the maximum measuring voltage and maximum voltage to earth ground (1000 V CATIII and 600 V CATIV, respectively) will not be exceeded.

Wear suitable Personal Protective Equipment (PPE) when carrying out measurements with the Clamp Meter.

Connecting Sequence

For safety reasons, when connecting a circuit to the Clamp Meter, proceed in the following sequence:

1. Turn on the Clamp Meter (utilize the ac power adapter if recording is required).
2. Connect the measuring circuit as shown in the relevant connection diagrams that follow.
3. To ensure the measured values are indicated correctly, confirm that the phase is connected to HI so that the energy flow is from HI to LO.
4. Observe the correct direction of current during measurements; the correct direction is indicated by an arrow on top of the Clamp Meter.

Overview

The Clamp Meter offers the following options for connection:

- Single-phase connection for voltage measurement.
- Single-phase connection for current measurement.
- Single-phase connection for power measurement.
- Three-phase connection for balanced power.

Voltage and Current Measurements

Warning

You could be seriously injured when touching connections, internal circuits, and measuring devices that are not properly connected to earth ground.

Note

Always adhere to the instructions regarding the sequence of connection.

Figure 7 shows the connections for voltage and current measurements. The image on the left depicts voltage measurement, while the image on the right illustrates current measurement.

Power Quality Clamp Meter
Connection to Circuits

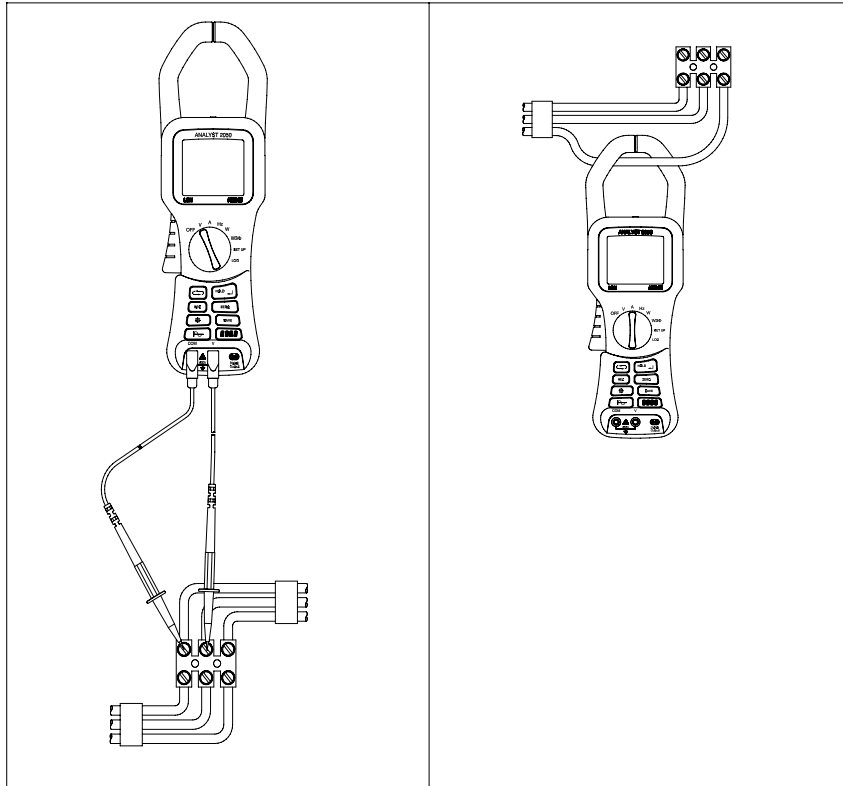

Figure 7. Voltage and Current Measurement Connections

eln07.eps

Single Phase Power Measurement Connection

The Clamp Meter is well designed for measurement of single-phase power networks.

Figure 8 shows the required connections for single-phase power measurement.

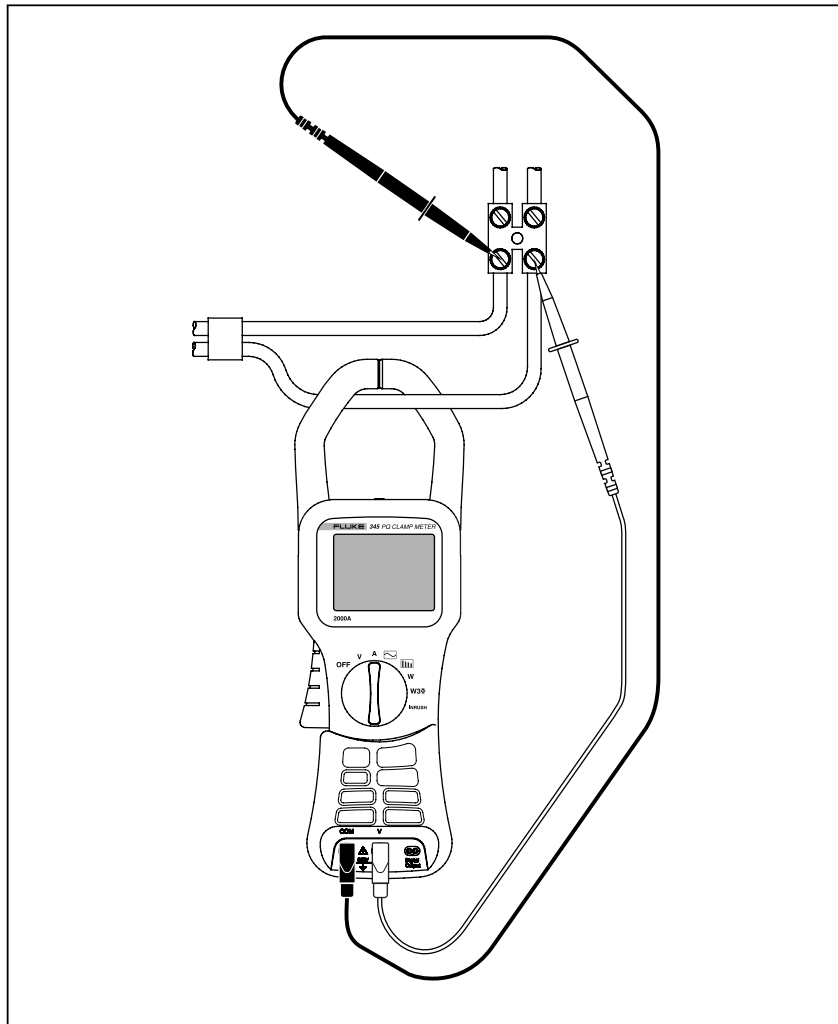

Figure 8. Single-Phase Power Measurement Connection

eln08.eps

Note

Carefully observe the direction of the current flow on the top of the Clamp Meter.

Note

Always adhere to the instructions regarding the sequence of connection.

Balanced Three-Phase Power Measurement Connection

In three-phase power networks where the load may be considered to be balanced, the Clamp Meter may be used to make some basic measurements such as watts, VA, PF, and kWhr.

Note

This measurement is only suitable for balanced loads. It is not suitable for measurements other than nominally balanced, due to the consideration of only one current phase.

Current is measured on one phase and the two voltages are measured on the remaining phase.

Figure 9 shows the three-phase setup screen for the balanced three-phase power measurement.

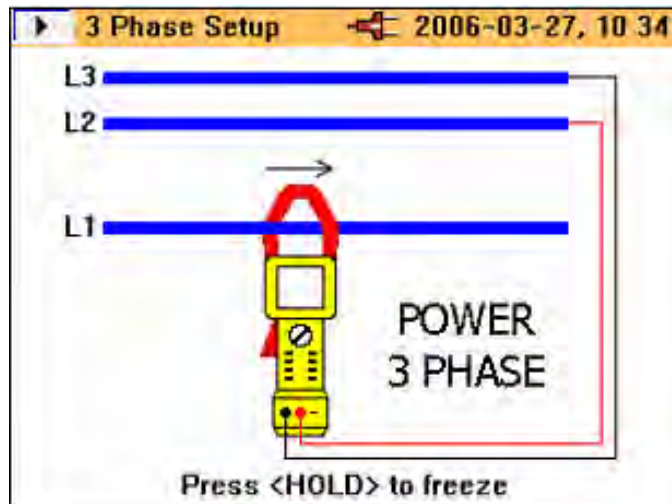

eln09.bmp

Figure 9. Three-Phase Power Connection

Note

Always adhere to the instructions regarding the sequence of connection.

Configuration

Operating Controls and Display

This section familiarizes you with some basic control elements, such as the display and the connections for the Clamp Meter.

The Clamp Meter is turned on and off by rotating the central selector switch. Turn the selector clockwise for **ON** and counterclockwise to turn **OFF**. Each of the available measuring functions is selected by turning the rotary selector to the required position.

Display Symbols

Figure 10 details the display symbols of the Clamp Meter.

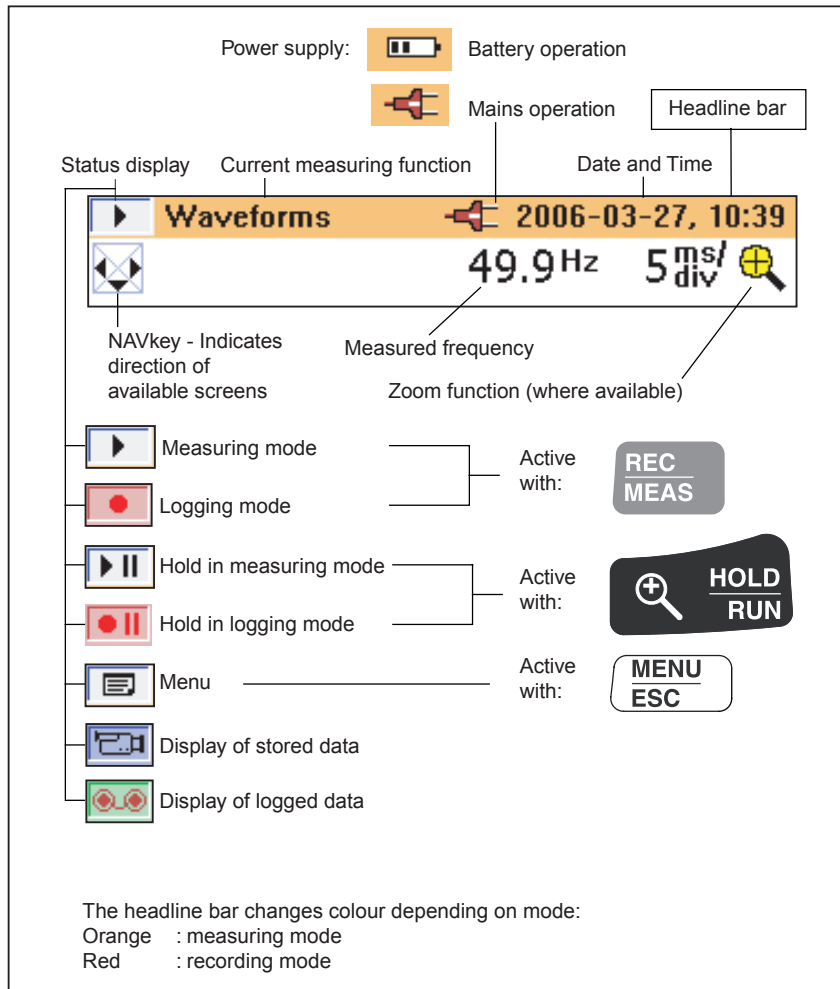

eln10.eps

Figure 10. Display Symbols of Clamp Meter







Available battery power is indicated as a set of bars. Four bars indicate maximum, one bar warns of minimum power, and no bars indicates batteries may fail within the next 30 minutes. All levels are approximate.

Navigation and Measuring Keys

All basic adjustments of the Clamp Meter are made through the main menu.

Table 2 shows the keys and their respective functions.

Table 2. Navigation and Measuring Keys

Keys	Function
	Used to call up the main menu
	Navigate up and down through menu options
	Indicates the direction to move through menu
	Used to select available items
	Indicates the available items
	Indicates the further items available in a sub-menu
	Used to access items available in a sub-menu and to save settings indicated onscreen. Also used to exit the setup menu, noted on the menu display as Select

Navigation through the Display

Use the navigation keys to navigate through the display and the menus.

Figure 11 shows the choices available when navigating through the display.

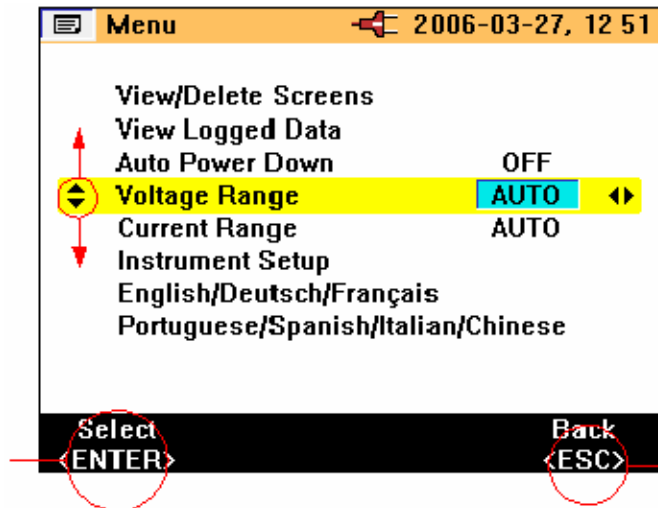

eln11.bmp

Figure 11. Navigation through the Display

Measurement Setup

Basic Adjustments Required before Measuring

Before making measurements, some basic items must be considered, such as:

- Auto Power Down: Select **OFF** (or **ON** to conserve battery life).
- Voltage ranging: Voltage range may be selected for automatic or manual operation (4 V, 40 V, 400 V and 750 V).
- Current ranging: Current range may be selected to operate automatically or manually (40 A, 400 A and 2000 A).

Additional instrument settings include:

- Low pass filter: Switch low pass filter **ON** or **OFF** to eliminate high frequency noise.
- PF/DPF Mode: Select either Power Factor or Displacement Power Factor.
- PF/DPF Display: Select displayed Power Factor.
- Harmonics type: Select either %H1 (fundamental) or %RMS.
- Date and Time: For time and date stamping of logged data.

Voltage Range Settings

To select either manual or automatic voltage ranging:

1. Press **▼ZERO** **▲☼** until **Voltage Range** is selected.
2. Press **◀** **▶** to change the setting. The available choices are AUTO, 4 V, 40 V, 400 V, and 750 V.
3. Press **ENTER SAVE** to confirm required change.
4. To exit without changing, press **MENU ESC**.

Figure 12 shows the voltage range settings for the Clamp Meter.



eln14.bmp

Figure 12. Voltage Range Settings

Current Range Settings

To select either manual or automatic current ranging:

1. Press **▼ZERO** **▲☼** until **Current Range** is selected.
2. Press **◀** **▶** to change the setting. The available choices are **AUTO**, 40 A, 400 A, and 2000 A.
3. Press **ENTER SAVE** to confirm selection.
4. To exit without changing, press **MENU ESC**.

Figure 13 shows the current range settings for the Clamp Meter.



eln15.bmp

Figure 13. Current Range Settings

Additional Instrument Settings

To view or adjust the additional settings:

1. Select **Instrument Setup** from the main menu.
2. Press **ENTER SAVE** to go activate the settings sub-menu.
3. Press **▼ZERO** **▲☼** to move cursor to the required item.

Figure 14 shows the available additional instrument settings for the Clamp Meter.







eln16.bmp

Figure 14. Additional Instrument Settings Menu

The items available in the additional Instrument Settings are:

- Low Pass Filter
- PF/DPF Mode
- PF/DPF Display
- Harmonics Type
- Buzzer Volume

These items may be changed by using the   keys.

Press  to confirm selections, or press  to exit without changing.

The Date and Time, Display Contrast, and Version and Calibration have sub-menus that are accessed by pressing  and the changes are effected in the same manner as previously detailed selections.

Figure 15 shows the items available in the additional instrument settings.



eln17.bmp

Figure 15. Additional Instrument Setting Items

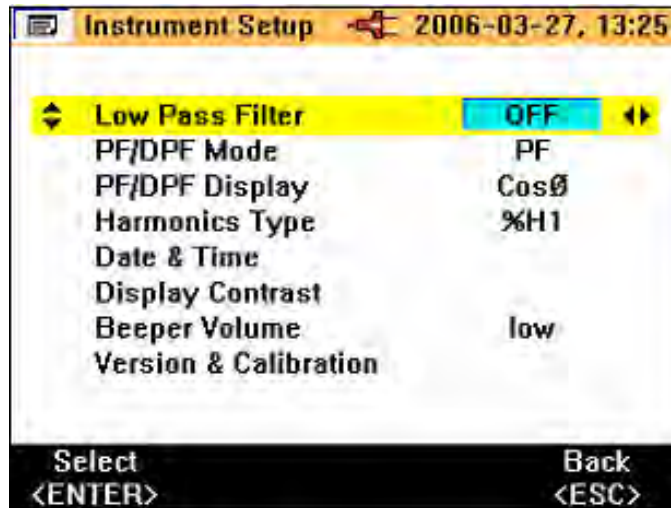
Measurements

Measurement Tips

Displaying Measurements

When the Clamp Meter is in measurement mode, generally more than one set of the measurements will be available.

Note

For more details, refer to each measuring mode in the “Measuring Functions Overview” section.

The availability of additional screens is indicated by the navigation keys



symbol that appears in the top left hand side of the display screen. The functions can be summarized as:



Is activated with



Is activated with



Is activated with



Is activated with



Indicates there are no other active screens

The required measurement parameters can be displayed by pressing their associated keys.

Saving Measurement Screens

During the measurement process, the display may be capture for viewing or later download.

To save a measurement screen:

1. Press  to initiate screen saving. The following message is displayed.

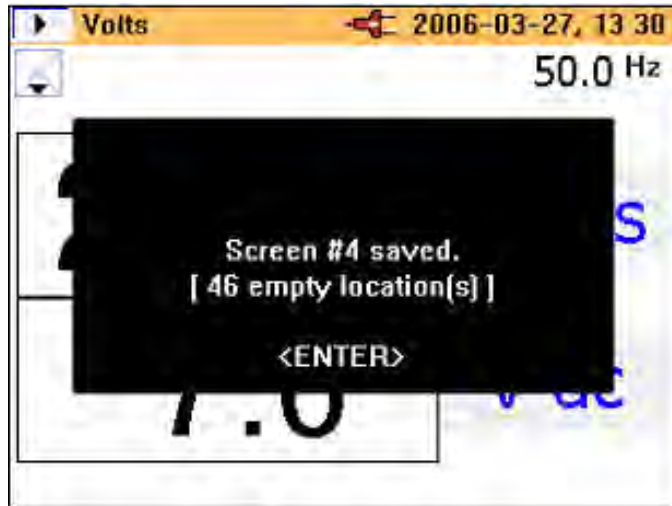

eln18.bmp

2. Press  to accept the screen displayed.



The screens are saved sequentially in the available memory locations. There are a total of 50 locations available.

The saved screen may be managed, that is, viewed and deleted, using the main menu. When the screen is saved, the following information is used to label the screen in memory:

- Measurement type
- Measurement state (Run or Hold)
- Date and time stamp

Viewing Saved Screens

To view the saved screens:

1. Press  to access the main menu. View/Delete Screens is the first available option in the menu.
2. Press  to go to View. The following screen is displayed.

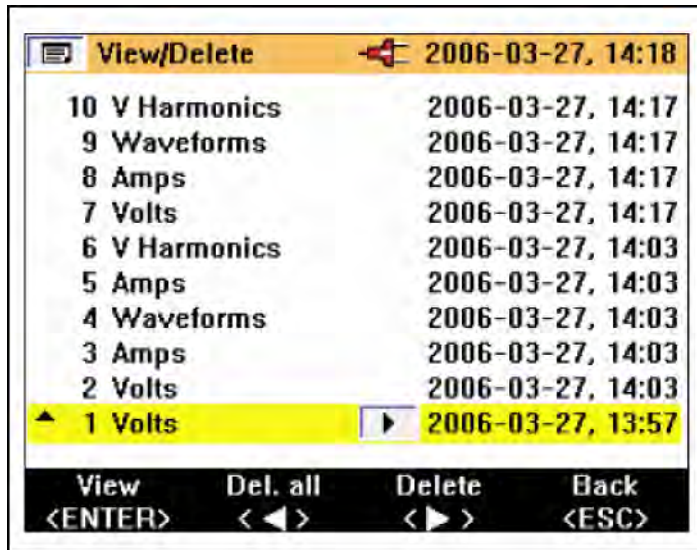

eln19.bmp

3. Press to select the screen required for viewing; recall the screen by pressing when the saved screen is highlighted.
4. Press and the saved screen is displayed.

Note

A warning is displayed at the top of the screen to indicate that the readings are not the active measurements. Screens may also be deleted in this mode.

Logging Tips

The Clamp Meter allows three kinds of Logging, and logged data is made up of average values. The detailed steps are outlined below, following a series of preliminary setup adjustments to ensure continuous power while recording or Logging.

Note

The Auto ranging option is initially highlighted, although it is recommended that the Auto ranging be switched off. Otherwise, if the instrument re-ranges during the recording scaling, there may be a gap in the recording as the instrument stabilizes.

Step 1 – Instrument Setup:

To setup the instrument:

1. Select an item using   and  .
2. Press  to go to the next step as shown in the following display.

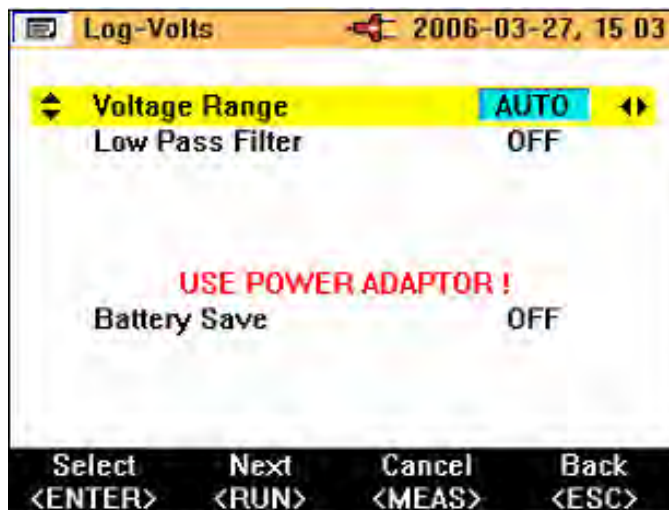

eln21.bmp

3. The battery save function may also be activated or deactivated in this screen.
4. Press  to go to the next step.



Note

It is recommended that the power adaptor be connected during Logging. If power to the adaptor is interrupted during the recording, the Clamp Meter internal batteries will continue to power the instrument.

The Battery Save function is still available when recording without the power adaptor connected.

This function is switched on or off using the ◀ ▶ keys. In this mode the instrument switches itself off after approximately 5 minutes to preserve battery power. The initiation of the power down function is indicated by an intermittent audible bleep.

Step 2 – Logging Setup:

Logging (recording) is initiated by pressing and holding  for approximately 3 seconds or until the Logging Area screen is displayed. On pressing the  button again, the step-by-step recording process begins.

The Clamp Meter has three logging areas available; recording area 1 is selected by default, as shown in the following display.

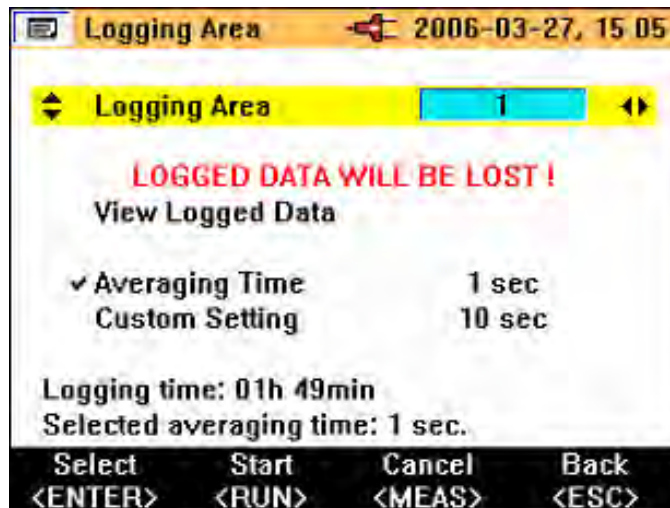



eln22.bmp

Select the Logging Area using ◀ ▶. There are actually four options to choose from: logging area 1, 2, and 3, or logging areas 1-2-3 combined for a longer logging time.

Any data present in Logging Area will be over-written during the logging process.



Power Quality Clamp Meter Measurements





Logged data is made up of averaged values. There are standard averaging times of 1, 2, 5, 10, 30 seconds and 1, 5, 10 and 15 minutes. Additionally, it is possible to customize the averaging time from 1 second to 900 seconds in 1-second steps.

The averaging time is selected by highlighting the item **Averaging Time** and using the   keys to select the required time, as shown in the following display.



eln23.bmp

If a non-standard averaging time is required, the **Custom Setting** may be highlighted using the   keys.

Use   and   to select the requested averaging time. The available logging time is indicated based on the logging area chosen and the average time selected. The logging time will vary depending on the measurement position. The logging times for each measurement mode and the available averages are detailed in the “Logging Times for Each Measurement Mode and Averages” section.

Press  to start recording. The message **LOGGING** is displayed, and then a trace appears on the instrument display as shown in the following display.



eln24.bmp

During the logging, the available measurements (and logged values) may be accessed using the navigation keys (see “Navigation and Measuring Keys” section). During the logging, the average values (the minimum and maximum values) are recorded for each average period, as shown in the following display.

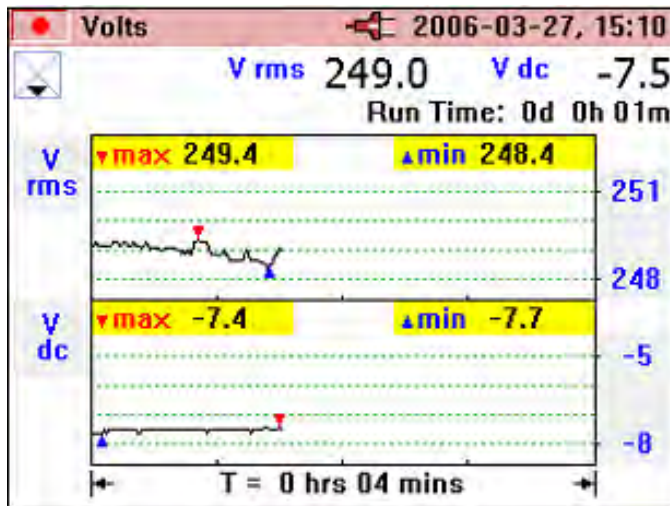

eln25.bmp

Power Quality Clamp Meter Measurements

The minimum and maximum values are based on half-cycle RMS values. Minimum and maximum values are indicated by blue and red triangles on the respective graphed values.

During logging, the headline bar is highlighted in red.

Logging may be stopped by pressing **REC MEAS** and a message **Stop Logging?** is displayed; to halt logging, press **ENTER SAVE** key as shown in the following display.

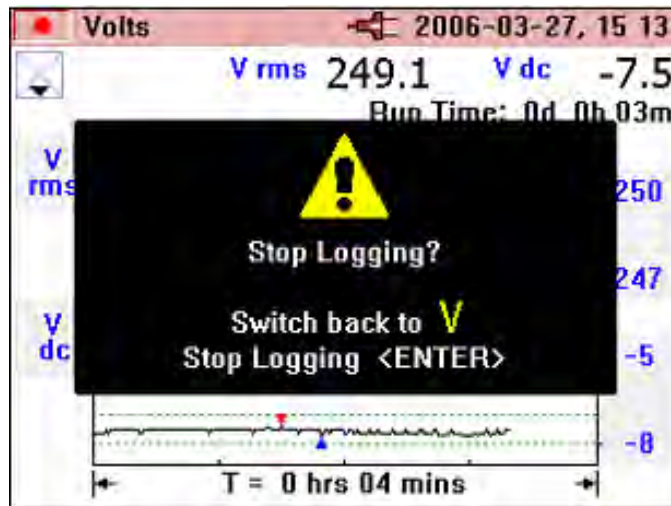

eln26.bmp

If the rotary switch position is changed during the logging, the message **Stop Logging?** appears onscreen; confirm by pressing **ENTER SAVE** to end logging. Alternatively, return the rotary switch to the original measurement position, and recording will continue.

Any logged data present in the Clamp Meter can be checked by pressing **MENU ESC** and selecting the "View Logged Data" menu item.

Press **ZERO** **▲** and select record with **ENTER SAVE** as shown in the following display.

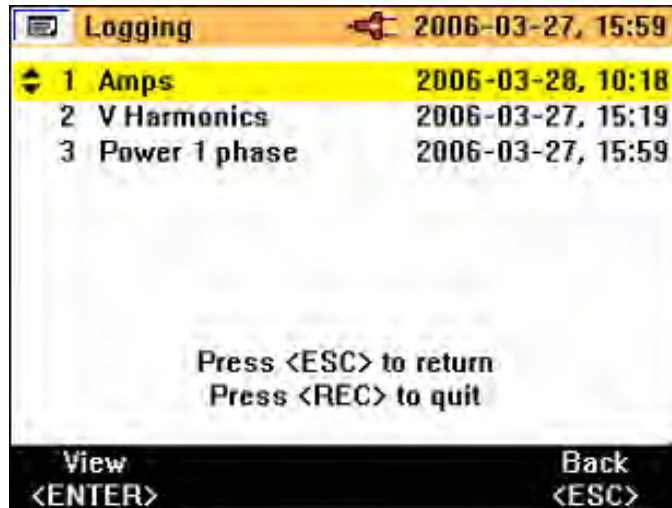

eln27.bmp

The log number and type of recording is shown with date and time stamp.

The logged data may be downloaded from the Clamp Meter via the USB cable and analyzed in detail on a PC using the supplied *Power Log* software package included on the CD.

Measurement Function Overview

Measurement modes are selected using the central rotary switch.

Voltage Measurements

The measurements available in measurement mode are described in Table 3.

Power Quality Clamp Meter
Measurement Function Overview

Table 3. Voltage Measurements

Measurement	Notation	Scales and Ranging	Associated Items and Comments
RMS voltage	V rms	Auto ranging or Manual	Minimum and maximum of all values. Recording of average values available. Total run time indicated in recording mode
dc voltage	V dc		
ac voltage	V ac		
Average voltage	V avg		
Peak voltage	V pk		
Volts frequency ratio	V/Hz		
Voltage ripple	%RPL		
Voltage crest factor	CF		
Frequency	Hz		

The following nominal value display screen is shown by default on entering the volts measurement mode.

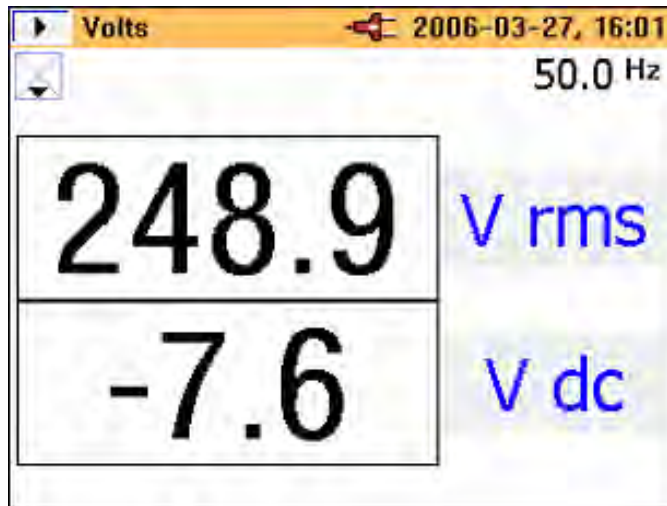

eln28.bmp

Two major values are displayed initially. Additional values may be accessed by pressing **▼ZERO**, which displays the following six-value screen.



eln29.bmp

Return to the previous screen by pressing **▲☼**.

The Minimum/Maximum value screens may be accessed by pressing **REC MEAS**. The live value will be displayed initially. In addition, the time (or Run Time) elapsed since the time the button was pressed will be indicated above the measurement in green text.

The minimum value (REC – MIN) registered during the elapsed period may be accessed by pressing **▶**. Additional presses will show the maximum registered value (REC – MAX) and average value (REC – AVG).

Pressing **◀** reverses the viewing process.

Note

Over-range values are indicated for all measurements with: **OL**.
 This applies to all measured values. Ensure the correct range is selected before proceeding to make any measurements.

Current Measurement

The measurements available in Current Measurement mode are described in Table 4.

Table 4. Current Measurements

Measurement	Notation	Scales and Ranging	Associated Items and Comments
RMS current	A rms	Auto ranging or Manual	Frequency also indicated. Minimum and maximum of all values. Recording of average values available. Total run time indicated in recording mode
dc current	A dc		
ac current	A ac		
Average current	A avg		
Peak current	A pk		
Current/frequency ratio	A/Hz		
Current ripple	%RPL		
Current crest factor	CF		

Navigation around the measurement screens and recording current are carried out in the same way as in the voltage mode.

Waveforms

The measurements available in Waveforms mode are described in Table 5.

Table 5. Waveforms Measurements

Measurement	Notation	Scales and Ranging	Associated Items and Comments
Voltage and Current waveforms	V+I waveforms	Two scales	Waveform phase difference and frequency. Sample value selected by measurement cursor
Voltage waveform	V waveform	One scale	
Current waveform	A waveform	One scale	
Voltage and Current waveforms	V+I waveforms	One scale	

This measuring function shows the voltages and currents in *oscilloscope* form, as well as their instantaneous values at the cursor position. This function clearly represents current and voltage waveforms and any distortion present.

On entry to Waveforms mode, the time base is set to 5 ms/div. The symbol  is shown next to this setting to indicate that a 2 sec press of the HOLD/RUN button will change the setting. So long as a plus sign is shown, the sweep speed can be increased. The minus sign is shown at 2.5 ms/div, when at the maximum speed.

The dual scale display screen shows the measured waveforms on separate grids with appropriate scales as in the display below.

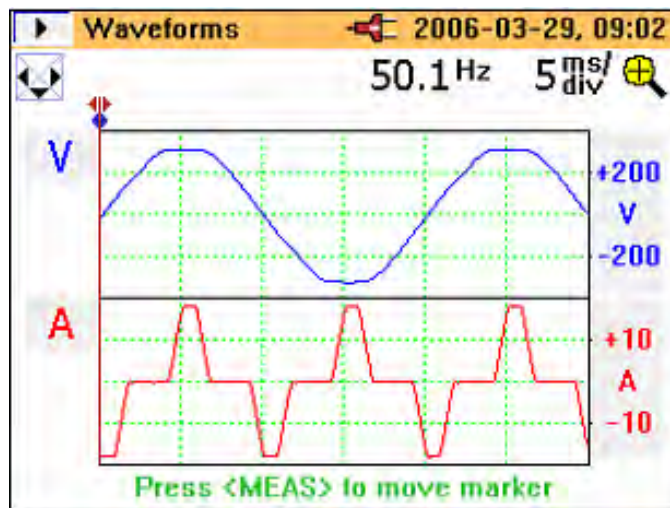



eln30.bmp

The frequency and phase difference are displayed above the waveforms.

The available time base values are 50, 25, 10, 5, and 2.5 ms/division.

Note



If a short press of  is made, the instrument enters the HOLD mode, and  must be pressed again to return to RUN mode before the time base can be changed.

Power Quality Clamp Meter Measurement Function Overview

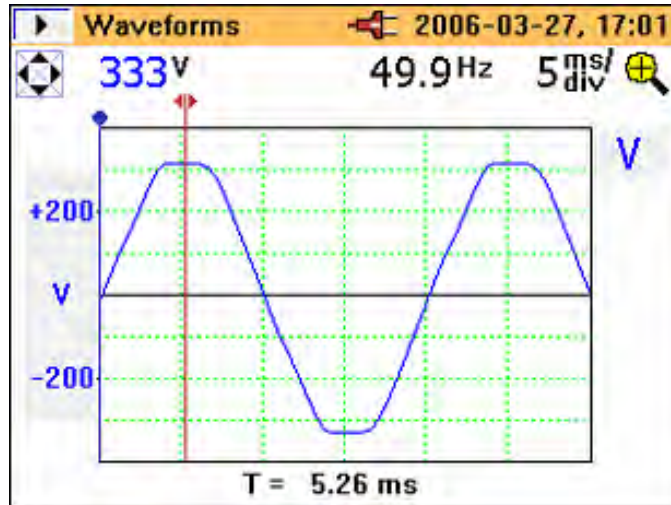
The single scale display shows the waveforms at maximum magnification with the V and A scales at either side of the waveforms, as shown in the following display.



eln31.bmp

The measurement cursor may be positioned using the keys   and the time ($T=n$ ms) is indicated on moving the marker.

Harmonics

Harmonics are sinusoidal voltage and current with a frequency that corresponds to an integer multiple of the fundamental of the mains (line) voltage. Any signal can be split into an infinite number of sine waves of different frequency and amplitude. The contribution of each of these individual sine waves is represented in a bar chart up to the 40th harmonic. The smaller the harmonics (starting from the 2nd harmonic, as the 1st is the fundamental), the better the power quality. Harmonics are an indication of the distortion present in the measured parameter. This is displayed as % total harmonic distortion (%THD) or distortion factor (%DF).

Harmonics may be represented as a percentage of the fundamental value (%H1) or as a percentage of the measured RMS value (%RMS) (See Table 6).

Table 6. Harmonics Measurements

Measurement	Notation	Scales and Ranging	Associated Items and Comments
Voltage harmonics 1st to the 40th	V _{fund} to V _{40th}	Adjustable zoom scale (100 %, 40 %, 10 % and 4 %)	RMS parameter, THD, individual harmonic value (V, A or W) or as % of fundamental or % of distortion factor
Current harmonics 1st to the 40th	V _{fund} to V _{40th}		

On first selecting the harmonics mode the ac RMS voltage and % distortion factor are displayed as shown following display.

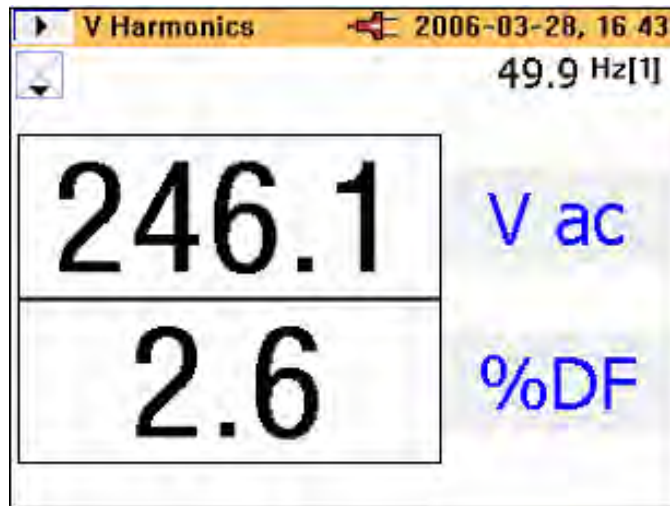

eln32.bmp

Other associated measured values are available by pressing the **▼ZERO** key.

Power Quality Clamp Meter
Measurement Function Overview

The second screen shows the fundamental voltage ac (V ac [1]) and %THD as shown in the following display.

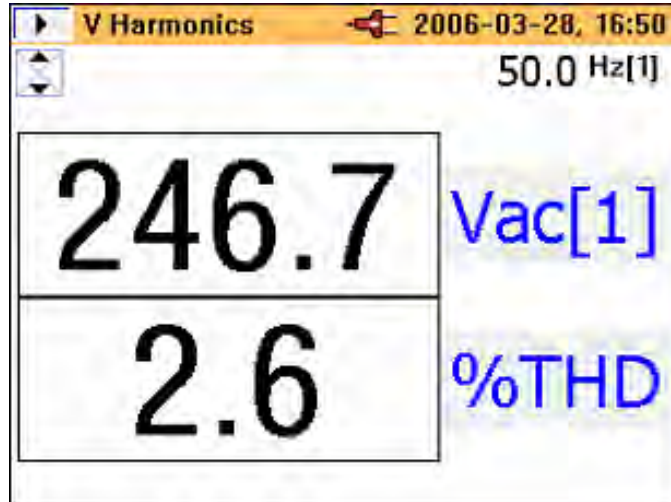

eln33.bmp

As shown below in the A Harmonics screen, **AUTO** indicates the percentage is automatically scaled to the max of H (2) and above. Pressing the  key for 3 seconds allows the scaling between values of 100 %, 40 %, 10 %, or 4 %, and then back to **AUTO**. The automatic scaling feature is necessary, as theoretically any harmonic beyond the fundamental can be as high as 600 % with respect to the fundamental (H (1)), since the Clamp Meter supports THD to 660 %. While 100 % can never be exceeded if %RMS is chosen from the menu, the scale could go as high 700 % if harmonic type %H1 had been selected. A scaling above 100 % is only available in the **AUTO** mode, where the scaling could be 200, 300, 400, 500, 600, or 700 % full scale.

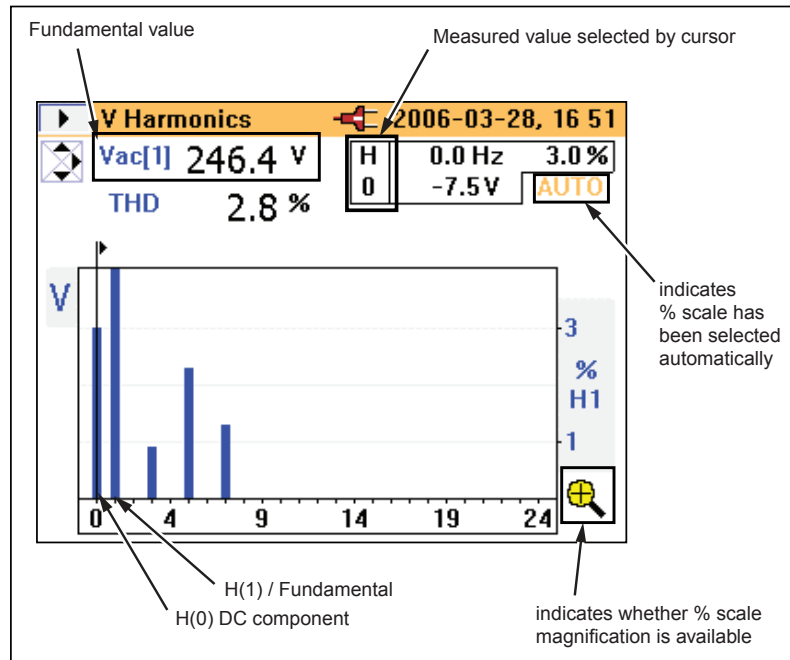

eln34.eps

A- detailed picture for current harmonics is presented in the same way.

The point at which input is over- or under-range is displayed as measured values in the following V Harmonics screen example.

Power Quality Clamp Meter
Measurement Function Overview

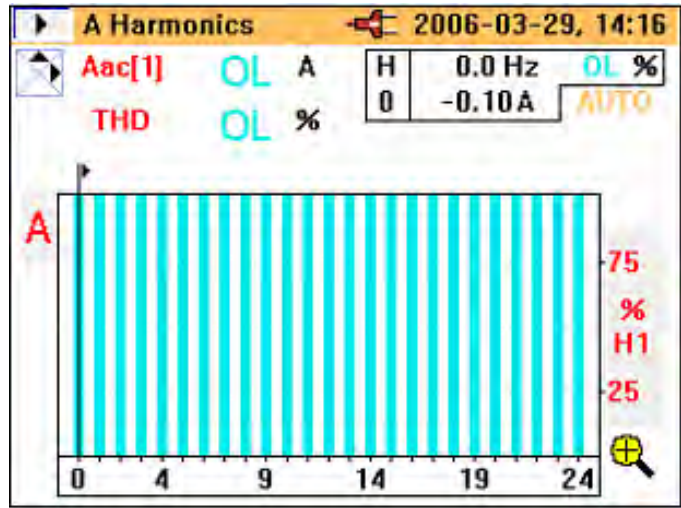

eln35.bmp

The scale is automatically set to 100 % and the overload (OL) symbol is displayed.

Harmonic Recording

Harmonic recording mode has two separate modes:

Mode	Recorded Harmonics
V (Voltage)	Vfund to V40th
A (Current)	Ifund to I40th

On entering the logging mode while still measuring harmonics, the mode voltage (V) or current (A) must be selected, as shown in the following Log-Harmonics screen.



eln36.bmp

The length of the time taken for recording will depend on the mode *and* recording area chosen. The type of harmonics to be logged, %H1 or %RMS, can also be selected.

Unlike other recording modes, the recorded parameter is not shown as a line recording against time on the instrument display. In this mode, the minimum and maximum values are shown as an orange bar; superimposed on the orange bar is a flat black bar that represents the most recently available measured value, as shown in the following display.

Power Quality Clamp Meter
Measurement Function Overview

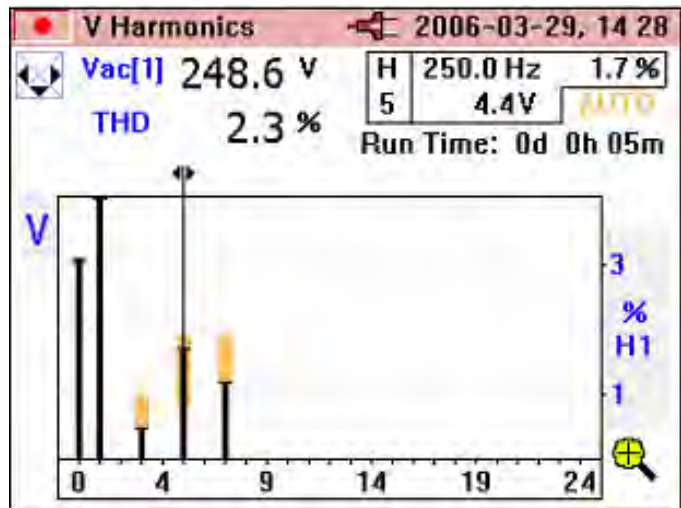

eln37.bmp

The upper part of the orange bar is the maximum value of the harmonic, and the lowest part of the orange bar is the minimum value measured during the logging period. The elapsed time of the logging period is displayed as **Run Time** on the display.

The cursor may be moved left or right to select individual harmonics from dc to the 40th harmonic.

Figure 16 shows the detailed view of the harmonic recording display.

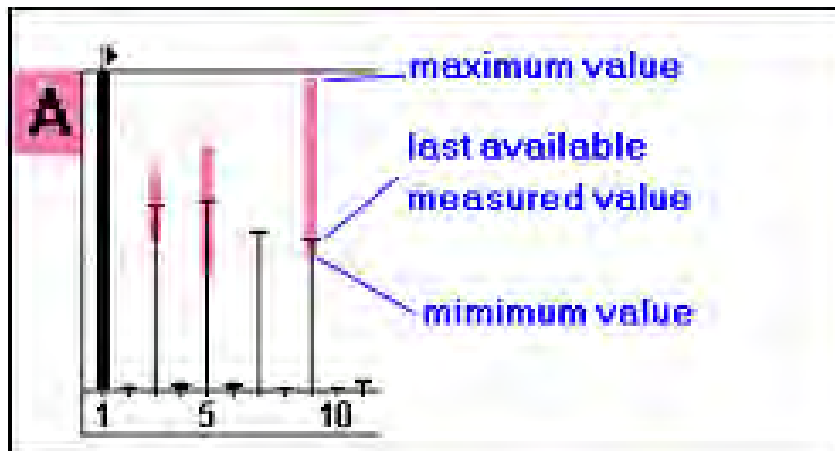

eln38.bmp

Figure 16. Detailed View of Harmonic Recording Display

W Power

The measured power and associated variables for this function are described in Table 7.

Table 7. Power

Measurement	Notation	Scales and Ranging	Associated Items and Comments
Power	kW	N/A	Frequency also indicated Minimum and maximum of all values Recording of average values available
Apparent Power	kVA		
Reactive Power	kVAR		
Power Factor*	PF		
Power Factor in degrees (cos ϕ)*	PF°		
Displacement Power Factor*	DPF		
Displacement Power Factor in degrees (cos ϕ)*	DPF°		
Voltage	Vac(1)		
Current	Iac(1)		
Energy**	kWhr		Measurement of these items is started in REC and logging mode. Total run time indicated on the display.
Apparent energy**	kVAHr		
Reactive energy**	kVARHr		
Ampere hours**	AHr		
* Selectable through instrument setup menu			
** Available in power logging mode			

Power Quality Clamp Meter
Measurement Function Overview

The measurement displays in the power mode offer all the available measurements on one screen as shown in the following display.

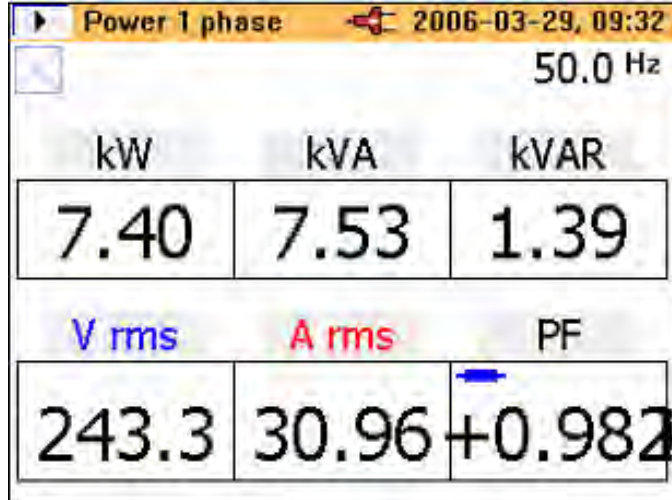

eln39.bmp

Initiating power logging is the same process used in the V and A modes.

Energy measurements are available while logging or REC mode. Since W is a signed value, WHr can go up or down, and can be either side of the zero axis. The same is true of VARHr as shown in the following display.

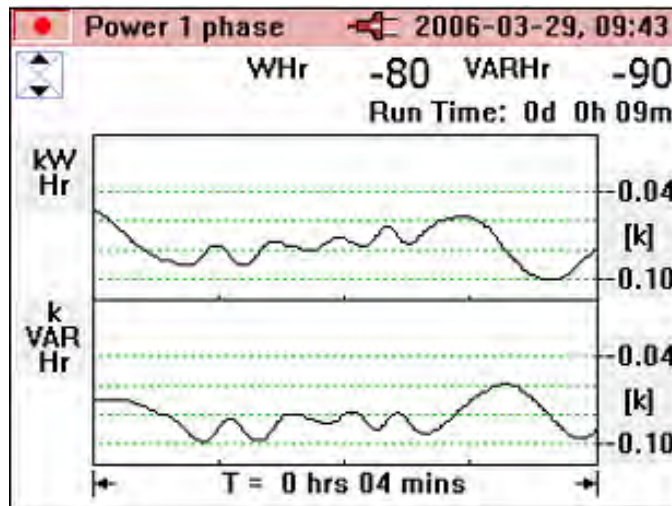

eln40.bmp

VA and AHr is unsigned, so can never decrease and never be below the zero axis as shown in the following display.

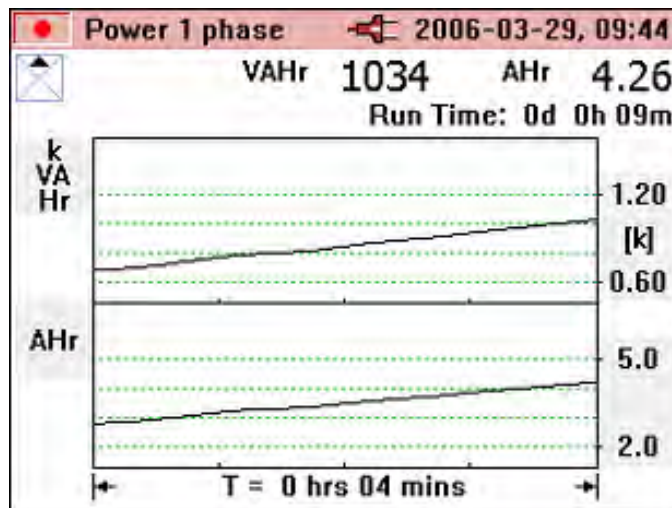

eln41.bmp

W3Φ Three-Phase Power

The three-phase power measurement and associated variables for this function are described in Table 8.

Table 8. Three Phase Power

Measurement	Notation	Scales and Ranging	Associated Items and Comments
Power	kW	N/A	Frequency also indicated Minimum and maximum of all values Recording of average values available
Apparent Power	kVA		
Reactive Power	kVAR		
Power Factor*	PF		
Power Factor in degrees (cos φ)*	PF°		
Displacement Power Factor*	DPF		
Displacement Power Factor in degrees (cos φ)*	DPF °		
Voltage	Vac(1)		
Current	Iac(1)		
Energy**	kWHr		Measurement of these items is started in REC and logging mode Total run time indicated on the display.
Apparent energy**	kVAHr		
Reactive energy**	kVARHr		
Ampere hours**	AHr		
* Selectable through instrument setup menu			
** Available in power logging mode			

This mode should only be used for balanced three-phase power; only one current-phase and two separate voltage-phases are considered accurate since true three-phase power cannot be guaranteed. The connected load must be well balanced, and connected in either Wye or Delta. This method will not provide accurate results where there is power distortion present.

For convenience on selecting this mode, a connection diagram is displayed on the Clamp Meter as shown in the following display.

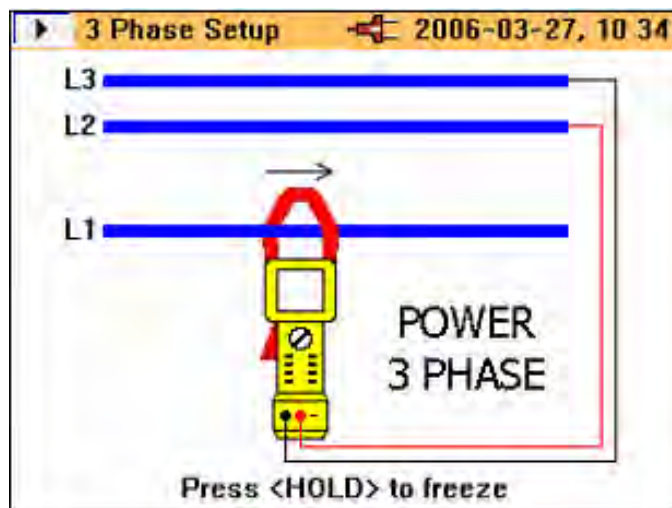

eln42.bmp

INRUSH Current

The Clamp Meter can capture current-triggered events, referred to as *inrush current*.

When the rotary selector is turned to the **INRUSH** position, the following screen is displayed.

Power Quality Clamp Meter
Measurement Function Overview

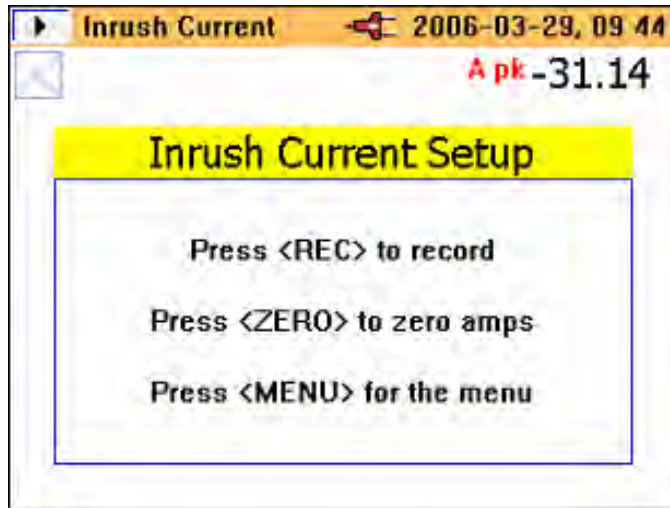

eln43.bmp

Press  to continue to enter the setup menu and the following screen is displayed.

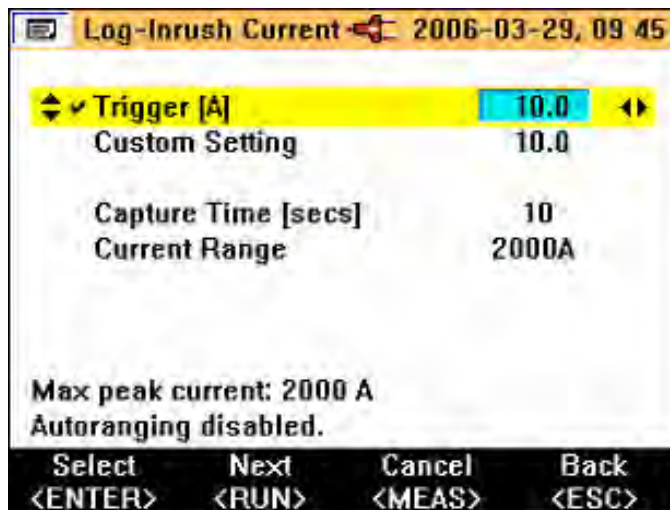

eln44.bmp

On this Log-Inrush Current setup screen, the peak current present at the instrument terminals is displayed (**Max peak current**) to provide guidance for the required trigger levels.

The current-trigger level may be selected from either a preset value of 0.5, 1, 3, 10, 30, 100, or 300 A, or a customized value from 0 to 1000 A in 0.1 A steps.

The capture time may also be chosen from 1, 3, 10, 30, 100, or 300 seconds. The capture time refers to the width of the time window on the Clamp Meter screen.

On pressing , the Logging Area settings screen, as shown below, indicates where the Inrush Current data will be stored. The logging areas 1, 2, 3 or areas 1, 2 and 3 combined may be selected.

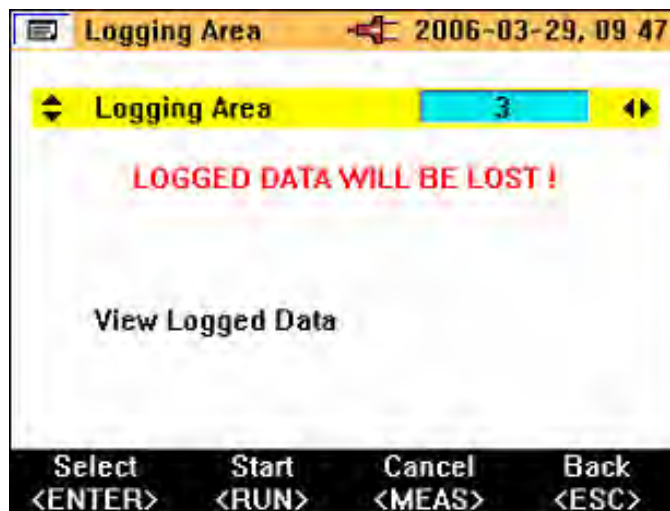

eln45.bmp

A single logging area can store about 1000 inrush captures.

Once the required settings are made, the instrument is ready for data capture; press  to start the capture.

Power Quality Clamp Meter
Measurement Function Overview

The Clamp Meter now waits for the trigger (current exceeding the preset level) as shown in the following display.

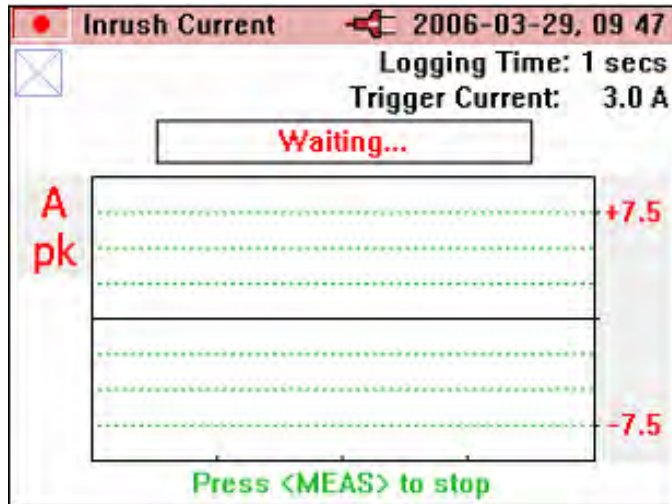

eln46.bmp

Once the trigger level is exceeded, the instantaneous values are drawn on the display and the message **Capturing...** appears as shown below.

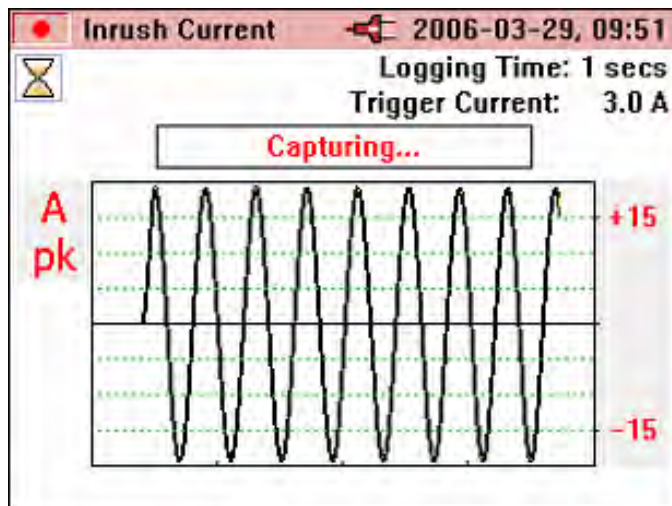



eln47.bmp

Once the inrush event is complete (that is, the capture time has elapsed), the message **WARNING – SCREEN NOT LIVE** flashes at the top of the display.

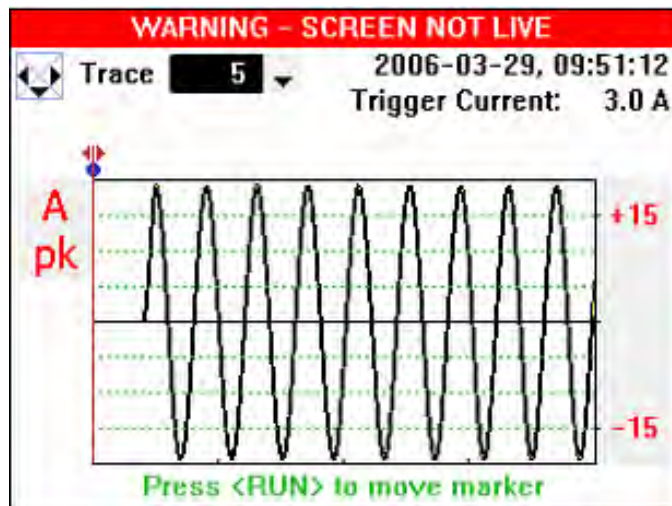
The **Trace** value is incremented accordingly as shown in the following display. In the following example, there are 5 traces stored.



eln48.bmp

Stored traces may be reviewed using the right and left the cursor keys. The inrush event may now be analyzed by moving the cursor across the captured signal using the   keys.

As the cursor is moved, the maximum and minimum vales at that point are displayed in the top right hand corner of the screen (there will be a group of values captured for each displayed point on the screen) as shown in the following display.

Power Quality Clamp Meter
Measurement Function Overview

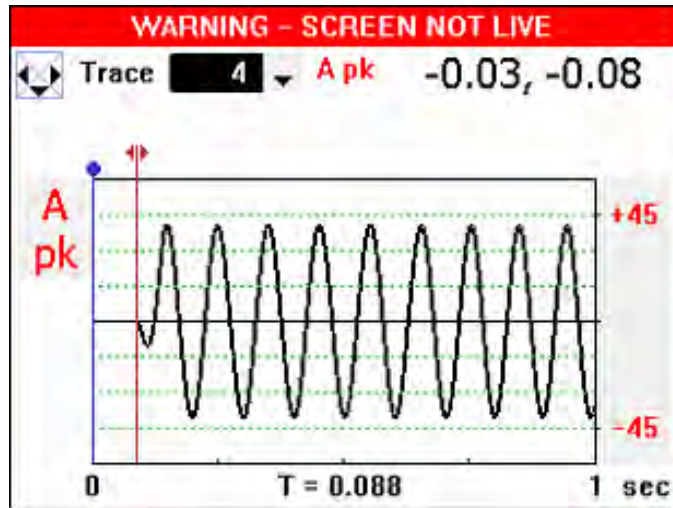

eln49.bmp

Once the cursor is in position, the blue marker can be shifted to that position by pressing the  key.

The cursor may now be moved again and the relative time (T=) will be indicated below the graph, as shown in the following display.

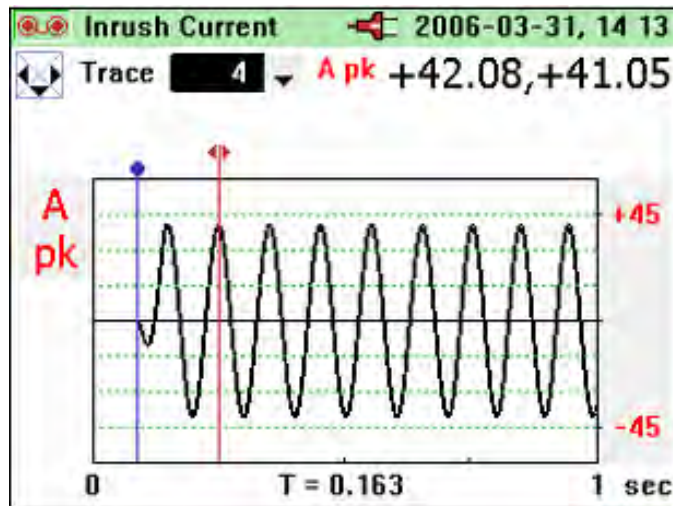

eln50.bmp

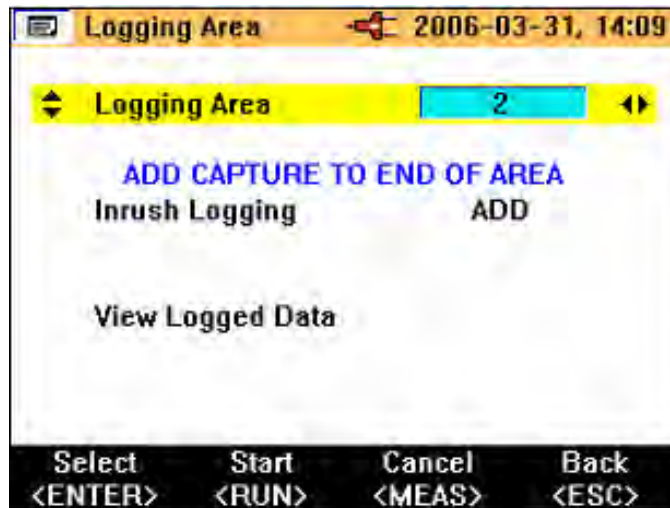

If additional inrush events are to be captured after exiting the inrush mode, these may be appended to an existing record by choosing a logging area that already contains inrush events, as in the screen displayed below. Alternatively, the old records may be overwritten by selecting the Inrush Logging item and choosing the **NEW** option (not shown).



eln51.bmp

INRUSH Recording Playback

Inrush records are stored in the same memory area as other logged data, and can be viewed on the Clamp Meter display. They may also be downloaded from the Clamp Meter and reviewed offline using the previously mentioned software and USB cable.

Viewing the recorded data is that same as any other logged data; to access these records, press . To view the logged data, select the **View Logged Data** menu option and press  as shown in the following display.

Power Quality Clamp Meter
Measurement Function Overview



eln52.bmp

Once in the View Logged Data sub-menu, select the appropriate record and press  to view the available recordings, as shown in the following display.

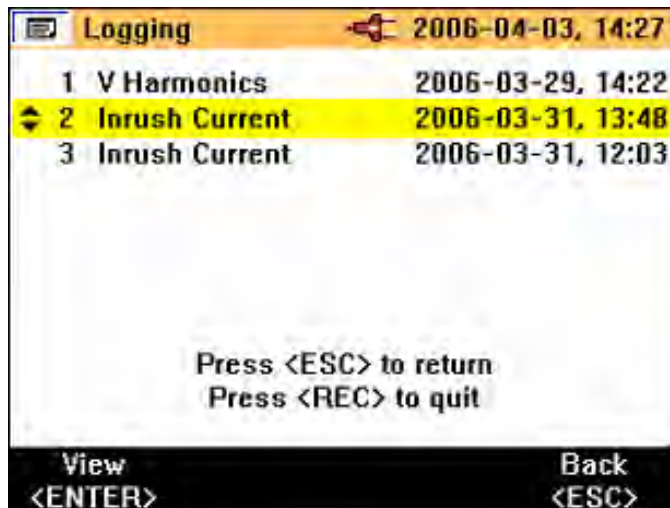

eln53.bmp

Initially, Trace 1 of the inrush logged data will be displayed, as indicated in the example below.

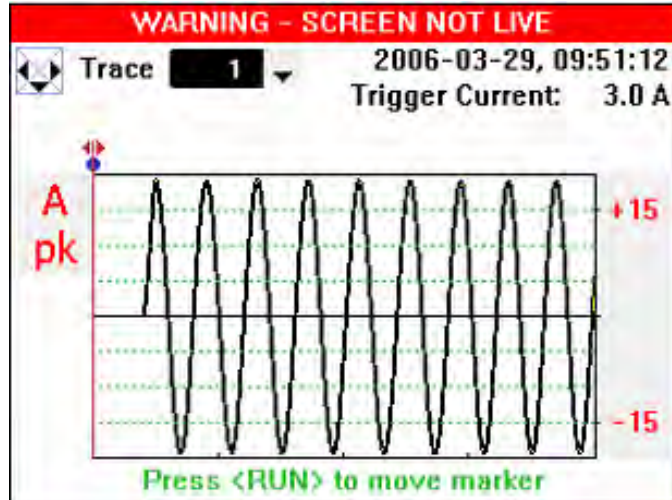

eln54.bmp

It is possible to scroll through the captured traces by pressing the up and down cursor, or **▼ZERO** or **▲** keys.

On selecting the saved inrush recording, captured screens may be viewed and analyzed in exactly the same way as described previously for the capture process.