

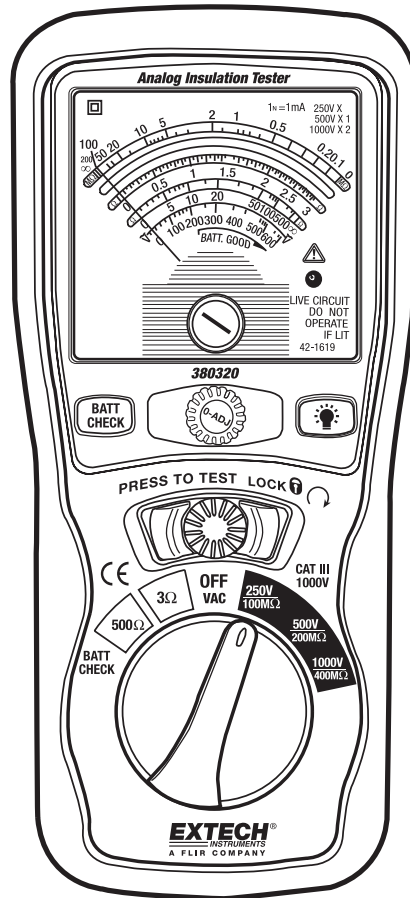

User's Guide

Analog High Voltage Megohmmeter Model 380320



Introduction

Congratulations on your purchase of the Extech 380320 Analog High Voltage Megohmmeter. The 380320 features three Insulation test ranges with a live circuit indicator, as well as low resistance and AC voltage measurements. The Power Lock On feature allows hands-free operation. This professional meter is shipped fully tested and calibrated and, with proper use, will provide years of reliable service.

Safety

International Safety Symbols



This symbol, adjacent to another symbol or terminal, indicates the user must refer to the manual for further information.



This symbol, adjacent to a terminal, indicates that, under normal use, hazardous voltages may be present



Double insulation

Safety Notes

- Do not exceed the maximum allowable input range of any function.
- Set the function switch OFF when the meter is not in use.
- Remove the battery if meter is to be stored for longer than 60 days.
- Circuits under test must be de-energized and isolated before connections are made (except for voltage measurements).
- Circuit connections must not be touched during a test. Use extreme caution when working near bare conductors and bus bars. Accidental contact with conductor could result in electrical shock.
- After insulation tests, capacitors must be discharged.

Warnings

- Set function switch to the appropriate position before measuring.
- When changing ranges always disconnect the test leads from the circuit under test.

Cautions

- Improper use of this meter can cause damage, shock, injury or death. Read and understand this user manual before operating the meter.
- Always remove the test leads before replacing the battery.
- Inspect the condition of the test leads and the meter itself for any damage before operating the meter. Repair or replace any damage before use.
- Use great care when making measurements if the voltages are greater than 25VAC rms or 35VDC. These voltages are considered a shock hazard.
- Voltage checks on electrical outlets can be difficult and misleading because of the uncertainty of connection to the recessed electrical contacts. Other means should be used to ensure that the terminals are not "live".
- If the equipment is used in a manner not specified by the manufacturer, the protection provided by the equipment may be impaired.

Meter Description

1. Analog display – See Display Description below
2. Batt Check key – Checks battery level (with TEST key)
3. 0 ADJ key – Adjusts Zero point for Analog display
4. Backlight key – Turns on Backlight
5. TEST/LOCK key – Enables Battery Check, Resistance, and Megohmmeter functions (can be locked by rotating clockwise)
6. Function Selector knob – Selects desired range and function

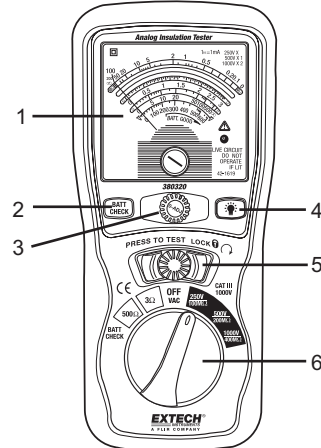

Top View

1. V Ω Test Lead Input
2. COM Test Lead Input

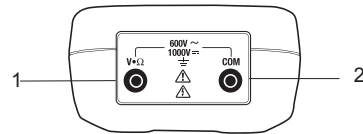



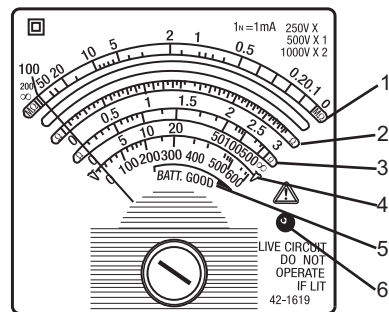

Display Description

1. Red: Megohmmeter Scale: Multiply reading by 0.5 (for 250V range), 1 (500V), 2 (1000V)
2. Green: Low Resistance Scale (0 to 3 Ω)
3. Green: Resistance Scale (0 to 500 Ω)
4. Blue: AC Voltage Measurement Scale (0 to 600V)
5. BATT GOOD indicator
6. LIVE CIRCUIT Indicator LED



Operation

CAUTIONS

-  Observe all safety precautions when the FUNCTION switch is set to the 250V, 500V or 1000V positions.
-  Connect the meter test leads to the circuit under test before operating the TEST key.
-  Do not touch the clip ends of the test leads when the TEST key is pressed.
-  Some electrical equipment, especially cables, may retain an electrical charge when disconnected from the line. It is good practice to discharge such equipment with grounding straps, or other suitable devices, before touching or making connections. The meter automatically discharges the test circuits when the spring loaded TEST key is released.

IMPORTANT NOTE

-  Remove all power to the circuit under test when making resistance measurements. If any voltage is present in the test circuit the red on the meter scale plate will light. Immediately disconnect test leads and turn off power to test circuit.

Live Circuit Indicator LED

If the Live Indicator status LED is lit, voltage is present on the device under test. DO NOT proceed to test with voltage present. Shock to the user and damage to the meter or device under test can result if testing is done with voltage present. Proceed with testing only when the voltage is removed from the device under test.

Connecting Test Leads

For all measurements, connect the red test lead to the V Ω input terminal and the black test lead to the COM input terminal.

Battery Check

1. Set the range selector switch to the BATT.CHECK position
2. Press and hold the TEST key.
3. Press the Batt Check key.
4. Observe the meter pointer. If the pointer falls in the BATT GOOD range of the bottom scale, batteries are good. If the pointer falls outside of (to the left of) the BATT GOOD area, replace the batteries.

Test Lead Check

1. Set the FUNCTION switch to the 3 Ω range.
2. Touch the test lead tips together and press the TEST key.
3. Resistance should read less than 0.5 Ω .
4. With the leads not touching, the display should read infinity.
5. Readings displayed other than the readings described above are indicative of a test lead problem. The test leads must be replaced before using the meter. Failure to do so could result in damage to equipment and electrical shock.

Megohm Measurements

1. Disconnect all power from the circuit to be tested.
2. Connect the red test lead to the $V\Omega$ input terminal and the black test lead to the COM input terminal.
3. Set the FUNCTION switch to the desired test range
4. Connect the test leads to the circuit to be tested



CAUTION: If the **LIVE CIRCUIT** indicator lights up at this point, **DO NOT** operate the TEST key. Remove the test leads and disconnect all power from the circuit.

5. Press and hold the TEST key to make the measurement. Turn the key clockwise to lock the test on.
6. Read the value on the **M Ω** scale and apply the range multiplier to determine the Megohm resistance reading.
7. Release or unlock the TEST key and allow the device to discharge before removing the test leads.

Range	Reading Multiplier
250V	0.5
500V	1
1000V	2

Resistance Measurements

WARNING: Do not run this test unless the voltage on the device under test is zero. If the Live Circuit status LED lights when a test is initiated, immediately abort the test and check that the circuit under test is not powered.

1. Set the Function select switch to the appropriate Resistance (3Ω or 500Ω) position.
2. Connect the red test lead to the $V\Omega$ input and the black lead to the COM input.
3. Perform a zero adjustment using the 0 ADJ screw on the unit as described below.
4. Connect the test lead tips to the circuit under test.
5. Press the TEST key. Lock by rotating clockwise if desired.
6. Read the resistance on the appropriate green display scale (3Ω or 500Ω).
7. Release or unlock the Test key.

Zero Adjust

1. Set the range selector switch to the 3Ω or 500Ω range.
2. Short the test leads together.
3. Press the Test key. Lock by rotating clockwise if desired.
4. Use the 0 ADJ control to align the display pointer with the 0 point on the 3Ω or 500Ω scale.
5. Release or unlock the Test key.

AC Voltage Measurements

1. Set the Rotary switch to the OFF/VAC position.
2. Connect the red test lead to the $V\Omega$ input and the black lead to the COM input.
3. Connect the other end of the test leads to the circuit under test.
4. Read the voltage value on the meter.

Battery Replacement

1. If the Battery Check indicates low battery power, the 6 AA batteries must be replaced.
2. Remove the test leads and turn the meter over.
3. Unsnap the tilt stand from the rear of the meter.
4. Remove the 4 Phillips head screws that secure the battery cover.
5. Remove the battery compartment cover
6. Replace the batteries, observing correct polarity.
7. Replace the battery compartment cover and secure the 4 screws.
8. Re-attach the tilt stand.
- 9.

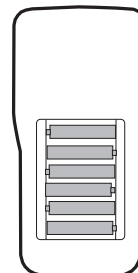

You, as the end user, are legally bound (**Battery ordinance**) to return all used batteries and accumulators; **disposal in the household garbage is prohibited!**

You can hand over your used batteries / accumulators at collection points in your community or wherever batteries / accumulators are sold!

Disposal: Follow the valid legal stipulations in respect of the disposal of the device at the end of its lifecycle

Specifications

General Specifications

Display	Multiband analog display with zero adjust
Live Circuit Indicator	LED lights when live circuit is sensed
Power supply	6 x 1.5V AA batteries
Power consumption	32mA
Fuse Protection	500mA 600V
Operating Temperature	0 to 40°C (32 to 104°F)
Operating Humidity	Below 80% RH
Altitude	Up to 2000 meters
Storage Temperature	-10 to 60°C (14 to 140°F)
Storage Humidity	Below 70% RH
Dimensions	200 x 92 x 50mm (7.9 x 3.6 x 2")
Weight	Approx. 700g. (24.7 oz) with batteries
CAT rating	CATIII 1000V & CATIV 600V

Resistance Specifications

Range	Resolution	Accuracy	MIN. Open Circuit Voltage	MIN Circuit Current
3Ω	0.05Ω	±3%	4.1V	200mA
500Ω	1Ω		4.1V	

AC Voltage

Range	Res.	Accuracy	Input impedance	Overload Protect
600VAC	20V	±5%	1.2MΩ	1000Vrms

Megohmmeter Specifications

Range	Accuracy		Terminal voltage
100MΩ / 250VDC	0.2MΩ to 5 MΩ	±5%	250V + 10% ~ -0%
	5M to 100 MΩ	±10%	
200MΩ / 500VDC	0.5MΩ to 10MΩ	±5%	500V + 10% ~ -0%
	10MΩ to 200MΩ	±10%	
400MΩ / 1000VDC	1 MΩ to 20 MΩ	±5%	1000V + 10% ~ -0%
	20 MΩ to 400 MΩ	±10%	

Range	Test Current / Load	Short circuit Current
100MΩ / 250VDC	1mA	Approx. 1.3mA
200MΩ / 500VDC		
400MΩ / 1000VDC		