

**WARNING**

Read these instructions and the warnings and instructions for all equipment being used before using to reduce the risk of serious personal injury.



- Always use safety glasses to reduce the risk of eye injury.
- Do not use handle extensions (such as a piece of pipe). Handle extensions can slip or come off and increase the risk of serious injury.

The RIDGID® 600 series lever benders are designed to easily bend materials such as copper, steel, stainless steel and other hard metal tube to a maximum of 180°. Built-in rollers and a heavy-duty handle design combine to produce high quality bends with greatly reduced effort when compared to conventional benders.

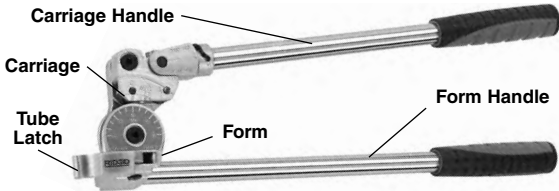

Figure 1 – 600 Series Bender

**NOTICE** Selection of appropriate materials and installation, joining and forming methods is the responsibility of the system designer and/or installer. Selection of improper materials and methods could cause system failure.

Stainless steel and other corrosion resistant materials can be contaminated during installation, joining and forming. This contamination could cause corrosion and premature failure. Careful evaluation of materials and methods for the specific service conditions, including chemical and temperature, should be completed before any installation is attempted.

**Inspection/Maintenance**

The bender should be inspected before each use for wear or damage that could affect safe use. Clean as needed to aid inspection and to prevent handles and controls from slipping from your grip during use. Make sure the bender is complete and properly assembled. If any problems are found, do not use until the problems are corrected. Lubricate all moving parts/joints as needed with a light lubricating oil, and wipe any excess oil from the bender.

**Operation**

The 600 Series Lever Benders can be used either hand held or with the bender mounted in a vise. Vise mounting is especially useful when bending hard or thick walled materials.

**Spring Back**

All tubing will exhibit spring back after a bend is completed. Softer tubing, such as copper, will have less spring back than harder tubing, such as stainless steel. Experience will help you predict the amount of spring back. Depending on tubing material and hardness, expect to overbend approximately 1° to 3° to compensate for spring back.

**General Operating Instruction**

1. Grasp bender by the Form Handle or mount the bender in vise. (Figure 2).

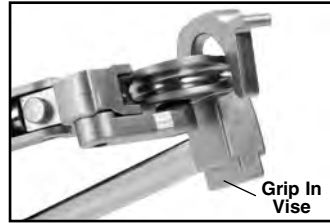

Figure 2 – Vise Mounting Point



Figure 3

2. Move Carriage Handle and Tube Latch away from Form.
3. Position tubing in Form groove and secure tubing in Form with Latch (Figure 3).
4. Lower Carriage Handle until the “0” Line on the Carriage aligns with the 0° designation on the Form (Figure 4).
5. Rotate the Carriage Handle around the Form until the “0” Line on the Carriage aligns with the desired degree of bend on the Form (Figure 5).

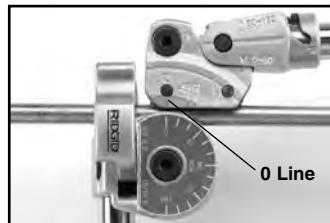

Figure 4



Figure 5

**Measured Bends Relative to Other Features (Tube ends, Bends, etc.)**

**For 90° Bends:**

- Mark the tube at the desired distance (X) from the feature (end of tube, bend, etc.). The center of the leg of the bend will be this distance from the feature.
- Place the tube in the bender as described in Steps 1-5 above.
- If the feature is to the **LEFT** of the mark (see Figure 6 – Before), align the mark on the tube with the “L” line on the Carriage.
- If the feature is to the **RIGHT** of the mark (see Figure 8 – Before), align the mark on the tube with the “R” line on the Carriage.

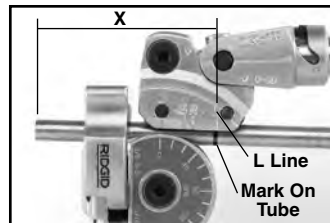

Figure 6 – Before

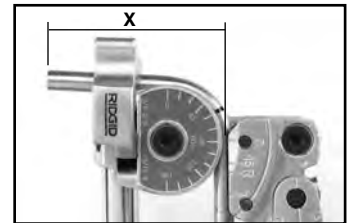

Figure 7 – After

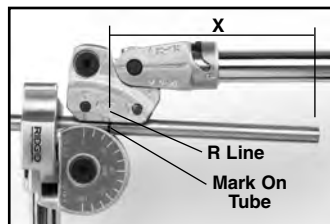

Figure 8 – Before



Figure 9 – After

- With the mark on the tube appropriately aligned, move the Carriage so that the “0” Line aligns with the 90 degree line on the Form. (See Figures 7 and 9 – After).

**For 45° Bends:**

- Mark the tube at the desired distance (X) from the feature (end of tube, bend, etc.). The center of the arc segment will be this distance from the feature.
- Place the tube in the bender as described in Steps 1-5 above.
- Align the mark on the tube with the 45° line on the Carriage (see Figure 10).

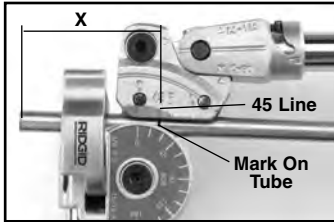

Figure 10 – Before

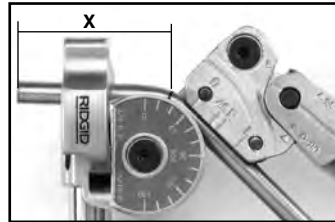

Figure 11 – After

- With the mark on the tube appropriately aligned, move the Carriage Handle so that the “0” Line aligns with the 45 degree line on the Form.

**Making Bends 90° to 180°**

Follow the steps 1-5 for making 90° bends.

1. When the “0” Line on the Carriage reaches the 90° mark on the Form, turn the carriage handle so that the pin moves the “unlock” position (Figure 12).



Figure 12 – UNLOCK

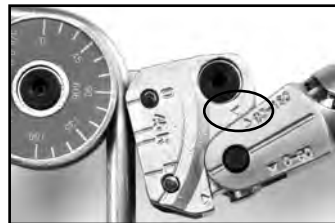

Figure 13 – Rotate Handle

2. Rotate the handle around the Carriage until the 90-180° triangle mark on the Handle aligns with the triangle mark on the Carriage (Figure 13).

3. Turn the Carriage Handle so that the pin moves toward the “lock” position. Make sure the Handle is secure to the Carriage. (Figure 14).



Figure 14 – LOCK



Figure 15

4. Swing the Carriage Handle around the Form until the “0” Line on the Carriage aligns with the desired bend angle (Figure 15). The Handles will not cross.

**Adjustment (Gain) Calculations**

When determining tube bend locations, adjustment factors must be considered to achieve proper layout. Adjustment (Gain) is the difference in the length of tubing used in a radiused bend compared to the length of tubing required in a sharp bend, when measured from one end to another.

The distance around a radiused bend is always less than a sharp bend.

The adjustment factor is determined by the radius of the tube bender and the number of degrees of the bend. See the following chart for adjustment factors. Adjustment factors are subtracted from the center line distances (see the example).

**Bend Adjustment Chart**

Model No.	603/604	605/606	608	606M	608M/610M	612M
Tube OD	3/16", 1/4"	5/16, 3/8	1/2	6mm	8mm, 10mm	12mm
Bend Radius	5/8	15/16	1 1/2	16mm	24mm	38mm
Degree	Bend Adjustment (Inches)			Bend Adjustment (mm)		
90	0.27	0.40	0.65	6.88	10.32	16.34
85	0.22	0.33	0.52	5.59	8.38	13.27
80	0.18	0.26	0.42	4.52	6.78	10.73
75	0.14	0.21	0.34	3.61	5.42	8.58
70	0.11	0.17	0.27	2.86	4.29	6.80
65	0.09	0.13	0.21	2.24	3.36	5.32
60	0.07	0.10	0.16	1.72	2.58	4.08
55	0.05	0.08	0.12	1.32	1.98	3.14
50	0.04	0.06	0.09	0.96	1.44	2.27
45	0.03	0.04	0.06	0.69	1.03	1.63
40	0.02	0.03	0.05	0.48	0.72	1.15

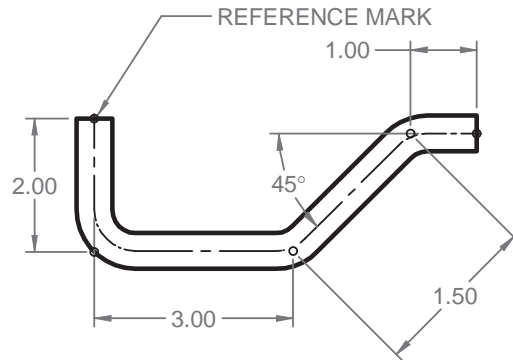

**EXAMPLE:**

TUBE SIZE = 3/8" Adjustment for 90° bend = 0.40 (x 1)  
 BEND RADIUS = 15/16" Adjustment for 45° bend = 0.04 (x 2)  
 (Values Found In Adjustment Chart)

ACTUAL TUBE = Sum of Centerline Dimensions - Adjustments for Bends  
 LENGTH REQUIRED = 2.00 + 3.00 + 1.50 + 1.00 - 0.40 - 0.04 - 0.04 = 7.02"

**Bender Specification**

Catalog No.	Model No.	Capacity (O.D.)	Bend Radius	Weight	
				lbs.	kgs.
38028	603	3/16"	5/8"	1.68	0.76
38033	604	1/4"	5/8"	1.68	0.76
38038	605	5/16"	15/16"	4.1	1.84
38043	606	3/8"	15/16"	4.1	1.84
38048	608	1/2"	1 1/2"	6.1	2.76
38053	606M	6mm	16mm	1.68	0.76
38038	608M	8mm	24mm	4.1	1.84
38058	610M	10mm	24mm	4.1	1.84
38063	612M	12mm	38mm	6.1	2.76

**Supporting Products Recommendation**

- Cat. No. 31803 65S Quick-Acting Tubing Cutter
- Cat. No. 29963 35S Stainless Steel Tubing Cutter
- Cat. No. 29993 227S Stainless Steel Inner-Outer Reamer
- Cat. No. 29983 223S Stainless Steel Inner-Outer Reamer