

RP 240/RP 241 Press Tools



- Français – 15
- Castellano – pág. 31
- Deutsch – 47

Table of Contents

Safety Symbols.....2

General Safety Rules

- Work Area Safety.....2
- Electrical Safety.....2
- Personal Safety2
- Power Tool Use and Care.....3
- Battery Tool Use and Care.....3
- Service4

Specific Safety Information

- Press Tool Safety4

RIDGID Contact Information.....4

Description.....5

Specifications.....7

- Standard Equipment.....7

Pre-Operation Inspection7

Set-Up and Operating Instructions.....8

- Removing/Installing Attachment8
- Preparing Connection8
- Pressing A Fitting With Typical Scissor Jaws8
- Pressing A Fitting With Typical Actuator And Press Ring Set9
- Inspecting The Pressed Connection10
- Bluetooth Functions (Wireless Data Transfer)10
- Cold Weather Operation10

Storage11

Maintenance Instructions11

- Cleaning And Lubrication.....11
- Troubleshooting.....11
- Required Maintenance By RIDGID Independent Service Center11
- Service And Repair.....12

Optional Equipment12

Disposal12

Electromagnetic Compatibility (EMC)12

FCC/ISED Statement12

EC Declaration of ConformityInside Back Cover

*Original Instructions - English

RP 240/RP 241

RP 240/RP 241 Press Tools



⚠ WARNING!

Read this Operator's Manual carefully before using this tool. Failure to understand and follow the contents of this manual may result in electrical shock, fire and/or serious personal injury.

RP 240/RP 241 Press Tools

Record Serial Number below and retain product serial number which is located on nameplate.

Serial
No.

Safety Symbols

In this operator's manual and on the product, safety symbols and signal words are used to communicate important safety information. This section is provided to improve understanding of these signal words and symbols.

 This is the safety alert symbol. It is used to alert you to potential personal injury hazards. Obey all safety messages that follow this symbol to avoid possible injury or death.

 **DANGER** DANGER indicates a hazardous situation which, if not avoided, will result in death or serious injury.

 **WARNING** WARNING indicates a hazardous situation which, if not avoided, could result in death or serious injury.

 **CAUTION** CAUTION indicates a hazardous situation which, if not avoided, could result in minor or moderate injury.

 **NOTICE** NOTICE indicates information that relates to the protection of property.



This symbol means read the operator's manual carefully before using the equipment. The operator's manual contains important information on the safe and proper operation of the equipment.



This symbol indicates the risk of hands, fingers or other body parts being crushed.



This symbol means always wear safety glasses with side shields or goggles when handling or using this equipment to reduce the risk of eye injury.



This symbol indicates the risk of electrical shock.

General Safety Rules*

WARNING

Read all safety warnings and instructions. Failure to follow the warnings and instructions may result in electric shock, fire and/or serious injury.

**SAVE ALL WARNINGS
AND INSTRUCTIONS FOR
FUTURE REFERENCE!**

Work Area Safety

- **Keep your work area clean and well lit.** Cluttered or dark areas invite accidents.
- **Do not operate power tools in explosive atmospheres, such as in the presence of flammable liquids, gases or dust.** Power tools create sparks which may ignite the dust or fumes.
- **Keep children and by-standers away while operating a power tool.** Distractions can cause you to lose control.

Electrical Safety

- **Power tool plugs must match the outlet. Never modify the plug in any way. Do not use any adapter plugs with earthed (grounded) power tools.** Unmodified

plugs and matching outlets will reduce risk of electric shock.

- **Avoid body contact with earthed or grounded surfaces such as pipes, radiators, ranges and refrigerators.** There is an increased risk of electrical shock if your body is earthed or grounded.
- **Do not expose power tools to rain or wet conditions.** Water entering a power tool will increase the risk of electrical shock.
- **Do not abuse the cord. Never use the cord for carrying, pulling or unplugging the power tool. Keep cord away from heat, oil, sharp edges or moving parts.** Damaged or entangled cords increase the risk of electric shock.
- **When operating a power tool outdoors, use an extension cord suitable for outdoor use.** Use of a cord suitable for outdoor use reduces the risk of electric shock.
- **If operating a power tool in a damp location is unavoidable, use a ground fault circuit interrupter (GFCI) protected supply.** Use of a GFCI reduces the risk of electric shock.

Personal Safety

- **Stay alert, watch what you are doing and use common sense when operat-**

* The text used in the General Safety Rules section of this manual is verbatim, as required, from the applicable UL/CSA 62841-1 standard. This section contains general safety practices for many different types of power tools. Not every precaution applies to every tool, and some do not apply to these tools.

ing a power tool. Do not use a power tool while you are tired or under the influence of drugs, alcohol, or medication. A moment of inattention while operating power tools may result in serious personal injury.

- **Use personal protective equipment. Always wear eye protection.** Protective equipment such as dust mask, non-skid safety shoes, hard hat, or hearing protection used for appropriate conditions will reduce personal injuries.
- **Prevent unintentional starting. Ensure the switch is in the off-position before connecting to power source and/or battery pack, picking up or carrying the tool.** Carrying power tools with your finger on the switch or energizing power tools that have the switch ON invites accidents.
- **Remove any adjusting key or wrench before turning the power tool ON.** A wrench or a key left attached to a rotating part of the power tool may result in personal injury.
- **Do not overreach. Keep proper footing and balance at all times.** This enables better control of the power tool in unexpected situations.
- **Dress properly. Do not wear loose clothing or jewelry. Keep your hair, clothing, and gloves away from moving parts.** Loose clothes, jewelry, or long hair can be caught in moving parts.
- **If devices are provided for the connection of dust extraction and collection facilities, ensure these are connected and properly used.** Use of dust collection can reduce dust-related hazards.
- **Do not let familiarity gained from frequent use of tools allow you to become complacent and ignore tool safety principles.** A careless action can cause severe injury within a fraction of a second.

Power Tool Use and Care

- **Do not force power tool. Use the correct power tool for your application.** The correct power tool will do the job better and safer at the rate for which it is designed.
- **Do not use power tool if the switch does not turn it ON and OFF.** Any power tool that cannot be controlled with the switch is dangerous and must be repaired.

- **Disconnect the plug from the power source and/or remove the battery pack, if detachable, from the power tool before making any adjustments, changing accessories, or storing power tools.** Such preventive safety measures reduce the risk of starting the power tool accidentally.
- **Store idle power tools out of the reach of children and do not allow persons unfamiliar with the power tool or these instructions to operate the power tool.** Power tools are dangerous in the hands of untrained users.
- **Maintain power tools and accessories. Check for misalignment or binding of moving parts, breakage of parts and any other condition that may affect the power tool's operation. If damaged, have the power tool repaired before use.** Many accidents are caused by poorly maintained power tools.
- **Keep cutting tools sharp and clean.** Properly maintained cutting tools with sharp cutting edges are less likely to bind and are easier to control.
- **Use the power tool, accessories and tool bits etc. in accordance with these instructions, taking into account the working conditions and the work to be performed.** Use of the power tool for operations different from those intended could result in a hazardous situation.
- **Keep handles and grasping surfaces dry, clean and free from oil and grease.** Slippery handles and grasping surfaces do not allow for safe handling and control of the tool in unexpected situations.

Battery Tool Use And Care

- **Recharge only with the charger specified by the manufacturer.** A charger that is suitable for one type of battery pack may create a risk of fire when used with another battery pack.
- **Use power tools only with specifically designated battery packs.** Use of any other battery packs may create a risk of injury and fire.
- **When a battery pack is not in use, keep it away from other metal objects, like paper clips, coins, keys, nails, screws or other small metal objects that can make a connection from one terminal to another.** Shorting the battery terminals together may cause burns or a fire.

- **Under abusive conditions, liquid may be ejected from the battery; avoid contact.** If contact accidentally occurs, flush with water. If liquid contacts eyes, additionally seek medical help. Liquid ejected from the battery may cause irritation or burns.
- **Do not use a battery pack or tool that is damaged or modified.** Damaged or modified batteries may exhibit unpredictable behavior resulting in fire, explosion or risk of injury.
- **Do not expose a battery pack or tool to fire or excessive temperature.** Exposure to fire or temperature above 265°F (130°C) may cause explosion.
- **Follow all charging instructions and do not charge the battery pack or tool outside the temperature range specified in the instructions.** Charging improperly or at temperatures outside the specified range may damage the battery and increase the risk of fire.

Service

- **Have your power tool serviced by a qualified repair person using only identical replacement parts.** This will ensure that the safety of the power tool is maintained.
- **Never service damaged battery packs.** Service of battery packs should only be performed by the manufacturer or authorized service providers.

Specific Safety Information

⚠ WARNING

This section contains important safety information that is specific to these tools.

Read these precautions carefully before using the press tools to reduce the risk of electrical shock or other serious injury.

**SAVE ALL WARNINGS
AND INSTRUCTIONS FOR
FUTURE REFERENCE!**

A compartment in the tool carrying case is included to keep this manual with the tool for use by the operator.

Press Tool Safety

- **Keep your fingers and hands away from**

pressing attachments during press cycle. Your fingers or hands can be crushed, fractured or amputated if they become caught between the attachment or between these components and any other object.

- **Never attempt to repair damaged pressing attachments (jaws, press ring, actuator, etc.). Discard the entire damaged attachment.** An attachment that has been welded, ground, drilled or modified in any manner can shatter during pressing resulting in serious injury. Failure to replace the entire pressing attachment may result in component failure and serious injury.
 - **Large forces are generated during product use that can break or throw parts and cause injury.** Stand clear during use and wear appropriate protective equipment, including eye protection.
 - **Only use RIDGID Press Tools with appropriate RIDGID pressing attachments (jaws, press ring, actuator, etc.).** Other uses or modifying the Press Tools for other applications may damage the press tool, damage the attachments and/or cause personal injury.
 - **Use proper tool, attachment and fitting combinations.** Improper combinations can result in an incomplete joint, which increase the risk of leaks, equipment damage and injury.
 - **Before operating RIDGID® Press Tool, read and understand:**
 - This operator’s manual,
 - The attachment instructions,
 - The battery/charger manual,
 - The fitting manufacturer’s installation instructions,
 - The instructions for any other equipment used with this tool,
- Failure to follow all instructions and warnings may result in property damage and/or serious injury.

Description

The RIDGID® RP 240 and RP 241 Press Tools, when used with appropriate attachments, are designed to mechanically press fittings onto tubing to create a water-tight and permanent seal, such as for plumbing and heating applications. Attachments are also available for other uses.

When the run switch on the press tool is depressed, an internal electric motor powers a hydraulic pump which sends fluid into the cylinder of the tool, moving the ram forward and applying force to the attachment, pressing the fitting. The press cycle takes approximately 5 seconds. Once the cycle begins to deform a fitting, it will automatically continue until completion, even if the run switch is released.

The Tool Status Lights indicate things such as improper temperature, low battery, or maintenance required. A work light turns on when the run switch is depressed to illuminate the work area. The head can be rotated for better access in tight spaces.

The tools are supplied with a fabric loop that can be used with appropriate attachments such as shoulder straps or tie off lines.

The press tools include Bluetooth® wireless technology to allow connection to smart phones and tablets. See “Bluetooth Functions (Wireless Data Transfer)” section for details.



Figure 1 – RIDGID RP 240 Press Tool and Compact Series Jaw

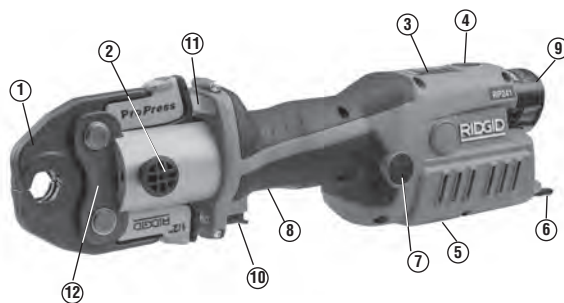

Figure 2 – RIDGID RP 241 Press Tool and Compact Series Jaw

#	Description
1	Scissor Style Jaw Set
2	Attachment Mounting Pin
3	Tool Status Lights
4	ON/OFF Button
5	Warning Label (RP 241 Underside)
6	Fabric Loop
7	Pressure Release Button (RP 240 Far Side)
8	Handle
9	Battery
10	Run Switch
11	LED Work Light
12	Jaw Sideplate

The Bluetooth® word mark and logos are registered trademarks owned by Bluetooth SIG, Inc., and any use of such marks by Emerson Electric Co. is under license. Other trademarks and trade names are those of their respective owners.

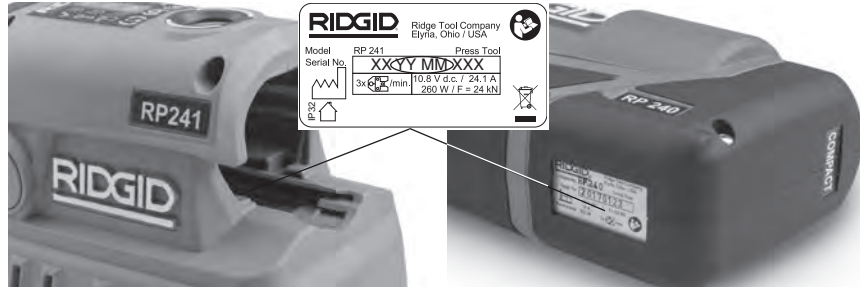

Figure 3 – Machine Serial Number - Circled digits indicate the year and month of the manufacture. (YY = year, MM = month).



Control	Marking	Description
ON/OFF Button		Main tool power switch (1 = ON, 0 = OFF). ON: Press button until light turns on. <i>See Figure 5 – Tool Status Lights</i> OFF: Press button until light turns off Tool will automatically turn OFF if left unused for ten (10) minutes.
Run Switch	—	Depress to start press cycle, release when tool locks on. Releasing the switch will not stop the tool once it has locked on. This assures consistent, repeatable press joint integrity.
Pressure Release Button		Allows tool to be released without completing press. If used, press connection is not complete and must be repeated
Attachment Mounting Pin	—	Holds attachment to tool. Must be fully inserted for tool to operate.

Figure 4 – Controls Chart

Icon	Solid Light	Blinking Light	Description
	Green		Press completed. Light on for 10 s or until Run Switch is pressed again.
	Blue		Bluetooth wireless is connected. <i>See Bluetooth Functions section.</i>
		Yellow	Indicates service interval approaching. Starts 2,000 cycles prior to service interval (30,000 cycles). Tool is usable, but tool will lock after service interval (32,000).
	Yellow		Tool is locked. Tool has completed service interval (32,000 cycles) and requires service. Tool has malfunctioned. Remove and reinsert battery. If still ON, have tool serviced.
		Red	Attachment mounting pin is not fully inserted.
	Red		Tool and/or battery out of Specification temperature range. Bring the tool and battery to correct operating temperature range.
	Green		Tool ON, ready to use.
		Red	Battery low. Tool will not operate. Recharge battery/Insert fully charged battery

Figure 5 – Tool Status Lights

Specifications

	RP 240 Pistol Press Tool	RP 241 Inline Press Tool
Attachments	RIDGID® Compact Series	RIDGID® Compact Series
Motor:		
Voltage	10.8 V d.c.	
Amperage	24.1 A	
Power	260 W	
Ram Force	5,400 lbs. (24 kN)	5,400 lbs. (24 kN)
Head Rotation	180°	180°
Duty Cycle	3 Press  /min.	3 Press  /min
Battery	12 V Li-Ion Rechargeable Battery Pack (RIDGID RB-1200 Series)	
Bluetooth Range	33 ft. (10 m)	
Ingress Protection	IP32	
Permissible Humidity	80% maximum	
Operating Temperature	15°F to 122°F (-10°C to 50°C)	
Weight	4.87 lbs. (2.21 kg)	4.72 lbs. (2.14 kg)
(No battery/attachment)		
Dimensions	10.6" x 2.9" x 8.7" 270 mm x 74 mm x 221 mm	13.4" x 3.4" x 4.4" 340 mm x 86 mm x 112 mm

Standard Equipment

Refer to the RIDGID catalog for details on equipment supplied with specific tool catalog numbers.

NOTICE Selection of appropriate materials and joining methods is the responsibility of the system designer and/or installer. Before any installation is attempted, careful evaluation of the specific service environment, including chemical environment and service temperature, should be completed. Consult Press Fitting System manufacturer for selection information.

Pre-Operation Inspection

⚠ WARNING



Daily before use, inspect your press tool and correct any problems to reduce the risk of serious injury from electric shock, crushing injuries, attachment failure and other causes, and prevent tool damage.

1. Remove battery from tool.

2. Clean any oil, grease or dirt from the equipment, especially the handles and controls. This aids inspection and helps to prevent the tool or controls from slipping from your grip.
3. Inspect the press tool for:
 - Proper assembly, maintenance and completeness.
 - Any broken, worn, missing, misaligned or binding parts. Confirm fabric loop is in good condition.
 - Smooth movement of attachment mounting pin between the fully open and fully closed position. Pin should lock into each position. Confirm that the run switch moves freely and does not bind or stick.
 - Presence and readability of warning labels. *See Figure 6.*
 - Any other condition which may prevent safe and normal operation.

Do not use the press tool until any problems have been repaired.

4. Inspect and maintain tool attachments per their instructions. Remove attachment from the tool. Confirm that attachments are in good condition and clearly marked as to use.
5. Inspect and maintain any other equipment being used per its instructions to make sure it is functioning properly.

Set-Up and Operating Instructions

⚠ WARNING



Keep your fingers and hands away from the tool attachment during the press cycle. Your fingers or hands can be crushed, fractured or amputated in the attachment or tool or between the attachment, work piece and other objects.

Large forces are generated during product use that can break or throw parts and cause injury. Stand clear during use and wear appropriate protective equipment, including eye protection.

Use proper tool, attachment and fitting combinations. Improper combinations can result in an incomplete joint, which increase the risk of leaks, equipment damage and injury.

Follow setup and operation instructions to reduce the risk of injury from crushing and other causes and to prevent tool damage.

1. Confirm have appropriate work area (See *General Safety Rules*). Operate in clear, level, stable, dry location. Do not use tool while standing in water.
2. Inspect work to be done and determine correct RIDGID tool and attachment for the application per their specifications. Using incorrect equipment for an application can cause injury, damage the tool and make incomplete connections.
3. Confirm all equipment has been inspected and set up as directed in their instructions.

Removing/Installing Attachment

1. Remove battery from tool.
2. Fully open the attachment mounting pin. Remove/insert the appropriate attachment (*Figure 6*).
3. Fully close the attachment mounting pin. The pin must be fully closed to prevent tool damage during use.



Figure 6 – Attachment Mounting Pin

Preparing Connection

NOTICE These instructions are generalized practices for several types of press tool attachments. Always follow the specific instructions for the press tool attachment being used and the fitting manufacturers' specific installation instructions to reduce the risk of improper press connections and extensive property damage.

1. Prepare the connection according to the fitting manufacturers' instructions.
2. With dry hands, insert a fully charged battery into tool. Depress ON/OFF button one time to turn tool ON. Green light at ON/OFF button should come on indicating that the tool is ready to use. See *Figure 5 – Tool Status Lights* for any other lights

NOTE: Tool will automatically turn OFF if left unused for ten (10) minutes.

Pressing A Fitting With Typical Scissor Jaws

1. Squeeze jaw arms to open jaws.
2. Place open jaws around fitting (*Figure 7*). Properly align jaw press profile with contour of the fitting as specified in Fitting Manufacturer's Installation Instructions. Release jaw arms to close jaws around fitting. Do not hang jaw set from fitting. Tool could unexpectedly drop and cause serious injury or death.



Figure 7 – Placing Scissor-Style Jaws Around Fitting

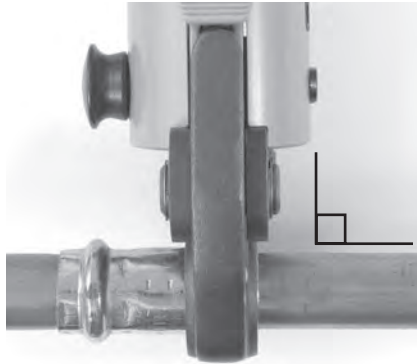

Figure 8 – Jaws Square to Fitting

3. Confirm jaw is appropriately placed and square to fitting. Keep fingers and hands away from the jaws to avoid crushing injuries in jaws or between jaws and surroundings.

Depress the run switch (*Figure 1/2*). Once the tool cycle begins and the rollers contact the jaw arms, the tool will lock-on and automatically complete the cycle. Releasing the switch will not stop the tool once it has locked on. This assures consistent, repeatable press joint integrity.

If tool must be removed before a connection is completed, depress the pressure release button (*Figure 1/2*). Any time release button is depressed, press is NOT complete and the connection must be pressed again to ensure completion. If the tool malfunctions during operation, use this procedure.

4. Release the run switch.
5. Squeeze jaw arms to open jaws.

6. Remove jaw from fitting. Avoid sharp edges that may have formed on fitting during pressing operation.
7. When operation is complete, depress On/Off button one time to turn tool OFF. Remove battery from tool.

Pressing A Fitting With Typical Actuator And Press Ring Set

1. Open ring and place around fitting. Properly align ring press profile with contour of the fitting as specified in *Fitting Manufacturer's Installation Instructions*. Release ring to close around fitting.
2. Confirm appropriate actuator is installed in tool. Squeeze actuator arms to open the actuator tips. Align actuator tips with ring pockets. Release actuator arms and fully engage actuator tips into ring pockets. Misaligning actuator tip to ring pocket can damage the ring or actuator during pressing. Do not hang tool and actuator from press ring. Tool could unexpectedly drop and cause serious injury or death.
3. Confirm ring is appropriately placed and square to fitting. Keep fingers and hands away from the actuator and ring to avoid crushing injuries in attachment or between attachment and surroundings.

Depress the run switch. Once the tool cycle begins and the rollers contact the jaw arms, the tool will lock-on and automatically complete the cycle. Releasing the switch will not stop the tool once it has locked on. This assures consistent, repeatable press joint integrity.

If tool must be removed before a connection is completed, depress the release button (*Figure 1/2*). Any time release button is depressed, press is NOT complete and the connection must be pressed again to ensure completion. If the tool malfunctions during operation, use this procedure.



Figure 9 – Installing Press Ring onto Fitting



Figure 10 – Attaching Actuator to Press Ring

4. Release the run switch.
5. Squeeze actuator arms to open actuator. Remove actuator from fitting.
6. Remove ring from fitting. Avoid sharp edges that may have formed on fitting during pressing operation.
7. When operation is complete, depress On/Off button one time to turn tool OFF. Remove battery from tool.

Inspecting The Pressed Connection

1. Inspect the pressed fitting for:
 - Full insertion of tube into fitting.
 - Excessive misalignment of the tubes. A slight amount of misalignment at a pressed connection is considered normal.
 - Incorrect attachment alignment with the fitting contour. Distorted or deformed fitting.
 - Any other issues per the fitting manu-

facturer. This could include the removal of a control ring or decal (used to indicate the connection has not yet been pressed).

If any issues are found, remove fitting and install a new connection.

2. Test connection in accordance with connector manufacturer instructions, normal practice and applicable codes.

Bluetooth Functions (Wireless Data Transfer)

The RIDGID® RP 240 and RP 241 Press Tools include Bluetooth® wireless technology allowing wireless data transfer to properly equipped smartphones or tablets (“devices”) running iOS or Android operating systems.

1. Download the appropriate RIDGID® app to your device by going to the Google Play Store or Apple App Store.
2. When the tool is ON, a Bluetooth wireless technology equipped device can find and pair with the press tool.
3. In the Bluetooth settings of your device, select desired RIDGID tool. Refer to your device instructions for specific information on how to connect via Bluetooth wireless technology. Once connected, the blue tool status light will be solid. After the initial pairing, most devices will automatically connect to the Tools when the Bluetooth wireless technology is active and in range. Press tools should be less than 33 ft. (10 m) from the device to be detected. Any obstacle between the tool and device can reduce the operational range.
4. Follow the app instructions for proper use. Among other things, the app allows monitoring of tool cycles.
5. The wireless data transfer turns OFF when the press tool is switched OFF. Turn Bluetooth wireless device OFF to reduce device battery drain.

Cold Weather Operation

As temperature drops, hydraulic fluid thickens and battery performance degrades. To reduce the risk of improper operation, the RP 240

The Bluetooth® word mark and logos are registered trademarks owned by Bluetooth SIG, Inc., and any use of such marks by Emerson Electric Co. is under license. Other trademarks and trade names are those of their respective owners. iOS is registered trademark of Apple Inc. Android and the Android logo are trademarks of Google Inc.

and RP 241 will not operate outside of the specification temperature range as indicated by the tool status lights (*Figure 5*).

When ambient conditions are outside the specification temperature range, keep the tool and batteries in a conditioned space until ready to use.

Storage

Remove battery from tool. Store press tool and battery in case. Avoid storing in extreme heat or cold. The tool will not turn ON if the tool is outside the specification range. This will be indicated by the tool status lights (*see Figure 5*).

⚠ WARNING Store tool in a dry, secured, locked area that is out of reach of children and people unfamiliar with the Press Tools. The tool is dangerous in the hands of untrained users.

Maintenance

⚠ WARNING
Make sure battery is removed from tool

before performing maintenance or making any adjustment.

Cleaning And Lubrication

1. Wipe the tool clean daily with a clean dry cloth.
2. Inspect the attachment mounting pin and lubricate the pin with silicone lubricant as needed.
3. Check return springs in attachments with each use. Attachments should open and close freely with only moderate finger effort required.

Required Maintenance By RIDGID Independent Service Center

The RP 240 and RP 241 Press Tools must be serviced at set intervals by a RIDGID Independent Service Center to ensure proper operation. This will be indicated by a tool status light (*See Figure 5*).

Troubleshooting

SYMPTOM	POSSIBLE REASON	SOLUTION
Tool will not turn ON when ON/OFF button is pressed.	Battery is completely discharged or battery has failed. ----- Battery not properly inserted into handle of tool.	Insert fully charged battery/recharge battery. ----- Check to assure battery is fully inserted.
Attachment is locked onto fitting.	Press was not successfully completed.	Push pressure release button to remove jaws from fitting. Inspect and repress fitting.
The pressed connections produced are not complete.	Used wrong jaws for the tube size or material. ----- The tool was not square to the tube. ----- Attachment press contour was not aligned with the fitting contour. ----- Tool is in need of repair.	Install the correct attachment. ----- Redo the joint with new fitting and new tube. Make sure that the tool is square to the tube. ----- Redo the joint with new tube and new fitting. Make sure the attachment press contour is aligned with the fitting contour. ----- <i>See Contact Information</i> for nearest RIDGID Independent Service center.
Oil leaks from tool.	Seal or mechanical problems.	
Motor runs but tool will not complete a cycle.	Oil level low.	<i>See Contact Information</i> for nearest RIDGID Independent Service center.
Tool stops during operation.	Oil level low.	

See Figure 5 for Tool Status Lights.

Service And Repair

⚠ WARNING

Improper service or repair can make the machine unsafe to operate.

Service and repair on the RP 240 and RP 241 Press Tools must be performed by a RIDGID Independent Press Tool Service Center.

For information on your nearest RIDGID Independent Service Center or any service or repair questions, see *Contact Information* section in this manual.

Optional Equipment

⚠ WARNING

To reduce the risk of serious injury, only use equipment specifically designed and recommended for use with the RIDGID RP 240 and RP 241 Press Tools, such as listed below.

RP 240 Press Tool

Catalog No.	Description
57418	RP 240 Battery Press Tool, Tool Only
57423	Carry Case, RP 240

RP 241 Press Tool

Catalog No.	Description
57288	RP 241 Battery Press Tool, Tool Only
57393	Carry Case, RP 241

Battery Packs

Catalog No.	Model	Capacity
55183	RB-1225	12V 2.5Ah Li-Ion

Battery will work with any catalog number RBC-121 Battery Charger.

RBC-121 Chargers and Cords

Catalog No.		Region	Plug Type
55193	Charger	USA, Canada and Mexico	A
55198	Charger	Europe	C
55203	Charger	China	A
55208	Charger	Australia & Latin America	I
55213	Charger	Japan	A
55218	Charger	United Kingdom	G
44798	Charger Cord	North America	A
44808	Charger Cord	Europe	C
44803	Charger Cord	China	A
44813	Charger Cord	Australia & LA	I
44818	Charger Cord	Japan	A
44828	Charger Cord	United Kingdom	G

Ridge Tool Company provides Compact series press attachments designed specifically for use with RIDGID Compact Press Tools. Only use attachments that are specifically designed to press the fitting system you are installing.

Disposal

Parts of these tools contain valuable materials and can be recycled. There are companies that specialize in recycling that may be found locally. Dispose of the components in compliance with all applicable regulations. Contact your local waste management authority for more information.



For EC Countries: Do not dispose of electrical equipment with household waste!

According to the European Guideline 2012/19/EU for Waste Electrical and Electronic Equipment and its implementation into national legislation, electrical equipment that is no longer usable must be collected separately and disposed of in an environmentally correct manner.

Electromagnetic Compatibility (EMC)

The term electromagnetic compatibility is taken to mean the capability of the product to function smoothly in an environment where electromagnetic radiation and electrostatic discharges are present and without causing electromagnetic interference to other equipment.

NOTICE These tools conform to all applicable EMC standards. However, the possibility of it causing interference in other devices cannot be precluded. All EMC related standards that have been tested are called out in the tool's technical document.

FCC/ISED Statement

This device complies with Part 15 of the FCC Rules. Operation is subject to the following two conditions:

1. This device may not cause harmful interference.

2. This device must accept any interference received, including interference that may cause undesired operation.

Modifications not expressly approved by this company could void the user's authority to operate the equipment.

This equipment has been tested and found to comply with the limits for a Class A digital device, pursuant to part 15 of the FCC Rules. These limits are designed to provide reasonable protection against harmful interference in a residential installation.

This equipment generates, uses, and can radiate radio frequency energy and, if not installed and used in accordance with the instructions, may cause harmful interference to radio communications.

However, there is no guarantee that interference will not occur in a particular installation. If this equipment does cause harmful interference to radio or television reception, which can be determined by turning the equipment off and on, the user is encouraged to try to correct the interference by one or more of the following measures:

- Reorient or relocate the receiving antenna (radio/TV device).
- Increase the separation between the equipment and receiver.
- Consult the dealer or an experienced radio/TV technician for help.

This product complies with the Canadian ICES-003 Class A specifications.

See Declaration label on tool.