

Instructions for Hard Hats

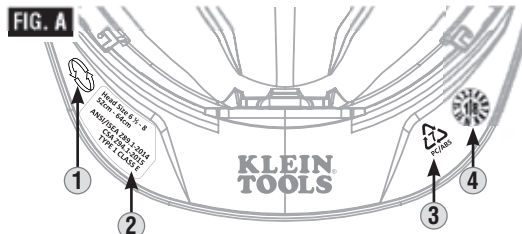

FIG. B

WARNING! BEFORE USE: READ ALL INSTRUCTIONS OR RISK SERIOUS INJURY OR DEATH. DO NOT REMOVE LABEL.

- This protective headwear is designed to absorb some of the energy of a blow through partial destruction of its component parts and, even though damage may not be readily apparent, any protective headwear subjected to severe impact should be replaced.
- This protective headwear must not be painted or cleaned with solvents. Any decals applied to the protective headwear must be compatible with the surface material and known not to affect adversely the characteristics of the materials used in the protective headwear.
- Any addition or structural modification may reduce the protective properties afforded by this protective headwear.

ATTENTION. AVANT UTILISATION: LIRE TOUTES LES INSTRUCTIONS OU RISQUE DE BLESSURES GRAVES OU DE MORT. NE PAS ENLEVER L'ÉTIQUETTE.

- Ce casque de sécurité est conçu pour absorber une partie du choc produit par un coup par la destruction partielle de ses composants. Même si l'endommagement n'est pas visible, tout casque de sécurité qui a subi un choc sévère devrait être remplacé.
- Ce casque de sécurité ne doit pas être peint ni nettoyé à l'aide de solvants. Toute décalcomanie appliquée à ce casque doit être compatible avec le matériau de la calotte et être reconnue inoffensive pour les matériaux entrant dans la fabrication du casque.
- Tout ajout au casque ou toute modification structurale du casque peut en réduire les propriétés de protection.

ADVERTENCIA! ANTES DE USAR: LEA TODAS LAS INSTRUCCIONES O PELIGRO DE LESIONES GRAVES O LA MUERTE. NO quite LA ETIQUETA.

- Esta gorra de protección está diseñada para absorber parte de la energía de un golpe a través de la destrucción parcial de sus componentes y, aunque el daño no sea aparente, debe reemplazarse cualquier gorro de protección que tenga un impacto severo.
- Esta gorra de protección no debe pintarse ni limpiarse con disolventes. Las calcomanías aplicadas a los sombreros protectores deben ser compatibles con el material de la superficie y se sabe que no afectan adversamente las características de los materiales utilizados en los sombreros protectores.
- Cualquier adición o modificación estructural puede reducir las propiedades protectoras proporcionadas por esta protección para la cabeza.

1370537 Rev. 01/19 E

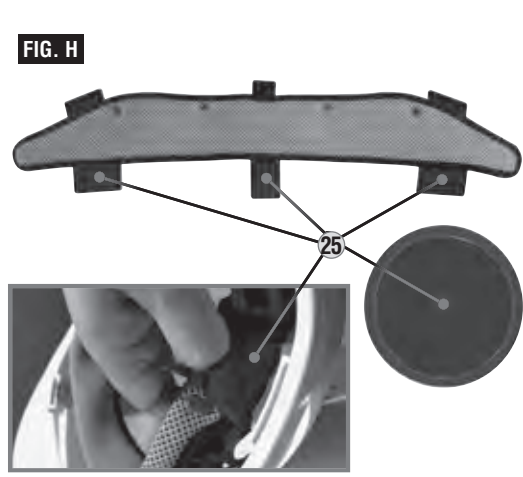
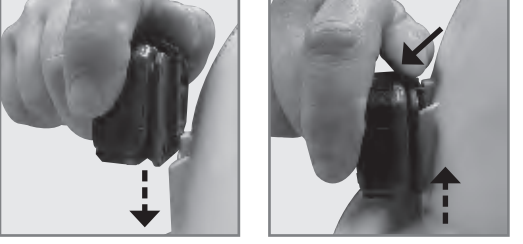
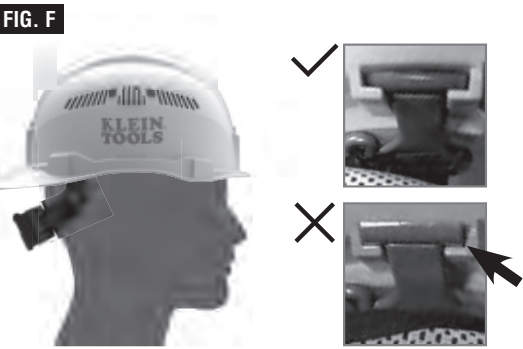
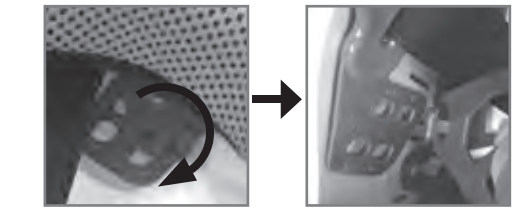
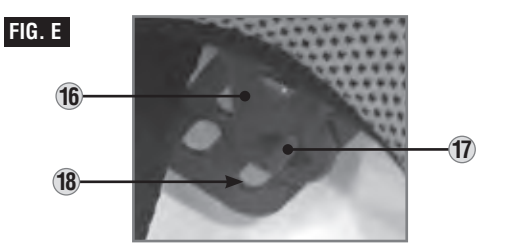
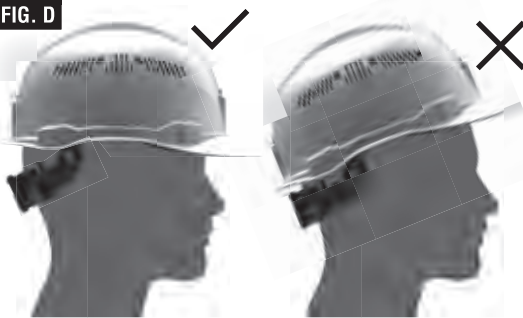
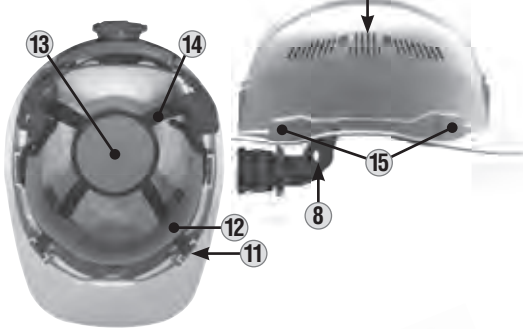
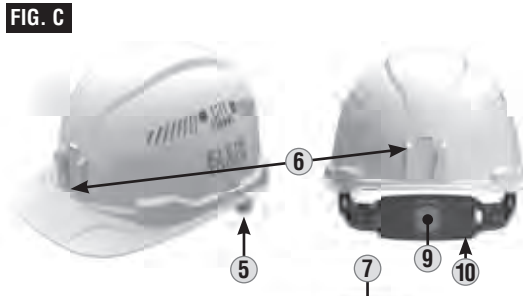
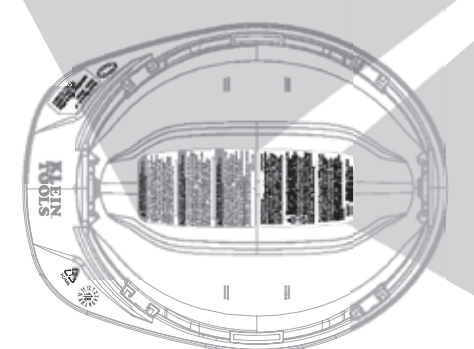

www.kleintools.com 1370496 Rev. 2/20 F

This hard hat provides LIMITED protection from small objects striking the top, front, back, left and right sides of the hard hat. This is NOT an ANSI/CSA Type II hard hat. NEVER use as a vehicular or sports helmet. Before using, replace any part showing wear or damage. Replace hard hat after any impact. Never alter or apply paints or solvents. DO NOT use for electrical shock protection. DO NOT expose safety hard hat, suspension, padding, and chin strap to open flame. (See Instructions).

Este casco de seguridad tipo cachucha proporciona protección LIMITADA contra objetos pequeños que golpean la parte superior, frontal, posterior, izquierda y derecha del casco de seguridad tipo cachucha. Este NO es un casco que cumple con las normas ANSI/CSA Tipo II. NUNCA lo use como un casco vehicular o deportivo. Antes de usar, reemplace cualquier pieza que muestre desgaste o daño. Reemplace el casco después de cualquier impacto. Nunca altere ni aplique pinturas o solvantes. NO lo use para protección contradescargas eléctricas. NO exponga el casco de seguridad, la suspensión, el acolchado y la correa de barbilla a llamas abiertas. (Consulte las instrucciones).

Ce casque de chantier offre une protection LIMITÉE contre les petits objets percutant le dessus, l'avant, l'arrière et les côtés du casque. Ce n'est PAS un casque ANSI/CSA de type II. N'utilisez JAMAIS comme casque de sport ou de véhicule. Avant toute utilisation, remplacez toute pièce présentant une usure ou des dommages. Remplacez le casque après tout impact. Ne jamais modifier ou appliquer des peintures ou des solvants. NE PAS utiliser pour la protection contre les chocs électriques. N'exposez PAS la coiffe, le rembourrage et la mentonnière à une flamme nue. (Voir les instructions).

GENERAL SPECIFICATIONS

- **Standards:** These Klein Tools Hard Hats comply with Type I ANSI/ ISEA Z89.1-2014, CSA Z94.1-15:
- Class E non-vented Hard hats have been tested up to 20KV.
- EN397:2012+A1:2012 (Clauses listed only):
- 5.2.4-Lateral Deformation (LD)
- EN12492:2012 (Listed clauses only):
- 4.2.1.2-Front Energy Absorption Capacity
- 4.2.1.3-Side Energy Absorption Capacity
- 4.2.1.4-Rear Energy Absorption Capacity



- **Fits:** Head Sizes 6-1/2 to 8 (20-1/2 to 25 inches / 52 to 64 cm)

SYMBOLS ON PRODUCT (FIG. A)

- 1 Reverse donning logo
- 2 Compliant Standards, Class, Type, and Head Size information
- 3 Recycling Code and material type
- 4 Date of manufacture

WARNING LABELS (FIG. B)

There are two warning labels affixed to the inside of this hard hat. Read, understand, and follow these instructions to ensure safe operation. **DO NOT REMOVE THESE LABELS.**

⚠ WARNINGS

READ ALL INSTRUCTIONS. FAILURE TO FOLLOW THESE WARNINGS AND INSTRUCTIONS MAY RESULT IN SERIOUS BODILY INJURY OR DEATH.

- This hard hat provides LIMITED protection from small objects striking top, front, back, left and right sides of the hard hat. This is NOT an ANSI/CSA Type II hard hat.
- **DO NOT** expose suspension and padding to open flame.
- **ELECTRICAL WARNING:** Avoid areas where the chance of electrical shock exists. Non-vented versions meet Class E requirements by providing limited electrical protection. Class C vented models provide NO electrical protection.
- If the hard hat has sustained an impact, dispose of it IMMEDIATELY, even if damage is not visible.
- **NEVER** alter, puncture, modify or engrave the shell or the suspension.
- **DO NOT** use paints, solvents, chemicals, adhesives, gasoline or like substances on this hard hat – doing so can lessen the protection offered against impact and penetration.
- **DO NOT** use this hard hat as a vehicular or recreational hard hat.
- **DO NOT** store objects between the suspension and the shell, as the hard hat will not function as intended and can lessen the protection from impact and penetration.
- Exposure to direct sunlight, corrosive environments, and/or extreme temperatures below -40°F (-40°C) or above 120°F (49°C) can lessen the ability of the hard hat to withstand impact and penetration.

MAINTENANCE

HARD HAT CLEANING AND STORAGE

- Clean the hard hat and suspension with mild soap and water only. Rinse and wipe dry. Clean optional chin strap with damp cloth only. Store in a cool place.
- See SWEATBAND AND TOP COMFORT PAD section of the operating instructions (on other side) for additional maintenance information.

INSPECTION AND REPLACEMENT

Inspect the hard hat, including the suspension and shell, before and after each use:

- Check the Hard Hat's shell for any cracks, breakage, discoloration, chalky appearance, or any other damage, excessive wear or unusual condition. These conditions may indicate reduced impact or penetration resistance and the Hard Hat must be replaced IMMEDIATELY.
- The suspension and optional chin strap should be checked for cracks, breaks, damaged stitching or any other damage, excessive wear or unusual condition. If any of these conditions exist, the suspension and optional chin strap must be replaced IMMEDIATELY.
- Always use genuine Klein Tools replacement parts. This product works as a system, and use of unauthorized suspensions may reduce the protection you receive from this hard hat.

USEFUL LIFE

SUSPENSION AND OPTIONAL CHIN STRAP: Must be replaced after no more than 12 months of use.

ENTIRE HARD HAT: Entire Hard Hat must be replaced after no more than 2 years of regular use, or 5 years from the date of manufacture, whichever comes first.

These are MAXIMUM useful service life guidelines. Regular inspection as detailed in the MAINTENANCE section above MUST be performed, and may result in possible earlier replacement.

NOTE: This replacement schedule is a guideline that assumes normal use and storage conditions for the hard hat. If the hard hat is exposed to temperature extremes, persistent sunlight, or chemicals, replacement may be required in a shorter time frame.

ACCESSORIES AND REPLACEMENT PARTS

Klein Tools hard hat accessories and replacement parts are available online or at major distributors:

- **KHHSPN:** Replacement Suspension
- **KHHSWTBND:** Sweatband (3-pack)
- **KHHTOPPAD:** Top Comfort Pad (3-pack)
- **KHHSTRP:** Chin Strap
- **56034:** Rechargeable Auto-Off Headlamp (Spot/Flood)
- **56049:** Rechargeable Light Array Headlamp (Flood only)
- **56062:** Rechargeable Headlamp / Worklight (Spot/Flood)
- **56048:** Rechargeable Auto-Off Headlamp (Spot/Flood)
- **KHH56220:** Headlamp / Magnetic Worklight (Spot/Flood)

NOTE: KLEIN TOOLS CANNOT GUARANTEE THAT THIRD-PARTY ACCESSORIES WILL PERFORM OR FIT OPTIMALLY WITH KLEIN TOOLS HARD HATS.

DISPOSAL / RECYCLE



Do not place hard hat or its accessories in the trash. Items must be properly disposed of in accordance with local regulations. See www.epa.gov for additional information.

FEATURE DETAILS (FIG. C)

- | | |
|-------------------------------------|---------------------------------|
| 5 Universal accessory slots | 12 Washable sweatband |
| 6 Klein Tools accessory slots | 13 Washable top comfort pad |
| 7 Vents with shutter (C-Class only) | 14 Suspension straps |
| 8 Pivot adjustment | 15 Reflective sticker locations |
| 9 Size adjustment knob | 16 Suspension bracket |
| 10 Rear neck pad | 17 Bracket key |
| 11 Suspension strap anchor slots | 18 Bracket key slots |

FITTING (FIG. D)

All hard hats come with suspension pre-installed at factory settings. The suspension can be adjusted to ensure proper and secure fit to your head for maximum protection. Follow the steps below:

STEP 1: Turn the size adjustment knob 9 counterclockwise to loosen the fit. Position the rear pad on the back of your head, closer to the neck. Dress any bandana knots or ponytails over the rear neck pad 10.

STEP 2: Tighten by turning the size adjustment knob 9 clockwise until the hard hat is comfortable and snug. Move your head up, down and side-to-side gently, like you would normally, and make sure the hard hat stays on. Make sure that the hard hat is not angled forward or backward, but rests level on your head.

ADJUSTMENTS (FIG. E)

If the hard hat does not fit properly at the factory settings, you can further adjust the fit:

STEP 1: Free the suspension by turning the suspension bracket 16 approximately 90 degrees to free the bracket key 17 from the bracket key slots.

STEP 2: Determine which slot 18 you want to reattach to. Using the bracket slots deeper in the hard hat will move it higher on the head and vice versa. Insert the bracket key 17 and turn the bracket 16 approximately 90 degrees to lock into

ADJUSTMENTS (FIG. E)

STEP 3: Verify the hard hat fits properly. Follow the steps in the FITTING section to ensure proper fit. Ensure that accessories you plan to use fit and function properly while maintaining the hard hat's ability to perform its function optimally. Check with a qualified safety expert, if unsure.

NOTE: The suspension strap lengths are fixed and cannot be adjusted. **DO NOT** attempt to alter.

REVERSE DONNING (FIG. F)

NOTE: Some jobsites may not permit reverse donning - Check with your jobsite's Safety Supervisor before changing your hard hat to this configuration.

STEP 1: Place your forefinger under the strap anchor, and your thumb over the anchor slot 19. Push up with forefinger using enough force to release the anchor from the slot. Do this for all anchor slots (4 total). **NOTE: DO NOT pull on the suspension straps to free the anchor. This could permanently damage the straps, preventing them from performing as intended.**

STEP 2: Make any height adjustments for the suspension before installation.

STEP 3: Push down each anchor until a click is heard and the anchor cannot be pushed down any further. Do this for all 4 anchors. **NOTE: DO NOT use sharp tools that may damage the anchors, or pull on the straps to secure the anchors.**

STEP 4: Check proper installation by pushing up on all 4 anchor bases. The anchors should remain fully seated in their slots. If not, repeat STEP 3.

STEP 5: Verify the hard hat fits properly. Follow the steps in the FITTING section to ensure proper fit. Also ensure that accessories you plan to use fit and function properly while maintaining the hard hat's ability to perform optimally.

SWEATBAND AND TOP COMFORT PAD (FIG. H)

Klein Tools hard hats come with an advanced sweatband and top comfort pad designed to wick away sweat. They are machine washable in a normal wash cycle. Do NOT wash with bleach or with detergents containing bleach. Machine dry on normal or low heat setting only.

The sweatband and top comfort pad can be easily removed and reinstalled on the suspension:

- The top comfort pad is held in place by a single hook-and-loop pad 25.
- The sweatband is held in place by four suspension hooks 26 and three hook-and-loop pads 25, on the side and front. To remove, simply detach all hook-and-loop pads and slide the sweatband off the suspension hooks.

VENTS (C-CLASS ONLY)

Klein Tools Class C hard hats have vents and shutters on both sides. The vents can be adjusted by simply sliding the shutter tabs 7 up or down.

⚠ The vents and shutters will NOT prevent vapors, liquids, or debris smaller than the vents from entering the hard hat.

56062 HEADLAMP (FIG. G)

The optional 56062 is a rechargeable headlamp designed specifically for Klein hard hats that have the integrated front and rear accessory slots. It functions as a spot light or flood light, and has magnet to attach onto magnetic surfaces for use as a worklight. Charging cable is included with models that include rechargeable headlamps.

- | | |
|-----------------------|-------------------|
| 19 Release tab | 22 Flood lights |
| 20 On/Off/Mode button | 23 Magnet |
| 21 Spot light | 24 Pivoting mount |

The 56062 can be attached to both the front and back of the hard hat via the Klein Tools accessory slot. It can be tilted up to 64 degrees on the hard hat and stand alone as a worklight.

To install the headlamp onto a Klein hard hat, align the pivoting mount 24 with the Klein Tools accessory slot 6 on the hard hat and push down until the headlamp clicks securely into place.

To remove the headlamp, press forward on the Release Tab 19, and lift the headlamp out of the accessory slot.

REFLECTIVE STICKERS (FIG. C)

Klein Tools hard hats come with four reflective stickers. For optimal performance, affix only to the designated areas 15. Do NOT apply stickers in areas that will impede the functionality of accessories or of the hard hat itself