

K-60SP Drain Cleaning Machine



• Français – 15

• Castellano – pág. 31

Table of Contents

Recording Form for Machine Serial Number	1
Safety Symbols	2
General Power Tool Safety Warnings	
Work Area Safety	2
Electrical Safety	2
Personal Safety	3
Tool Use and Care	3
Service	3
Specific Safety Information	
Drain Cleaner Safety	4
RIDGID® Contact Information	4
Description, Specifications and Standard Equipment	
Description	5
Specifications	5
Standard Equipment	5
Machine Inspection	6
Machine Setup	6
Operating Instructions	8
Special Procedures	
Reverse Operating Instructions	9
Jaw Set Adjustment	9
Accessories	10
Maintenance Instructions	
Lubrication	11
Cables	11
Clutch Jaw Assembly	11
Drive Belt Replacement	12
Machine Storage	13
Service and Repairs	13
Wiring Diagrams	14
EC Declaration of Conformity	Inside Back Cover
Lifetime Warranty	Back Cover

*Original Instructions - English

Drain Cleaner

K-60SP Drain Cleaning Machine



⚠ WARNING!

Read this Operator's Manual carefully before using this tool. Failure to understand and follow the contents of this manual may result in electrical shock, fire and/or serious personal injury.

K-60SP Drain Cleaning Machine

Record Serial Number below and retain product serial number which is located on nameplate.

Serial
No.

Safety Symbols

In this operator's manual and on the product, safety symbols and signal words are used to communicate important safety information. This section is provided to improve understanding of these signal words and symbols.

 This is the safety alert symbol. It is used to alert you to potential personal injury hazards. Obey all safety messages that follow this symbol to avoid possible injury or death.

⚠ DANGER DANGER indicates a hazardous situation which, if not avoided, will result in death or serious injury.

⚠ WARNING WARNING indicates a hazardous situation which, if not avoided, could result in death or serious injury.

⚠ CAUTION CAUTION indicates a hazardous situation which, if not avoided, could result in minor or moderate injury.

NOTICE NOTICE indicates information that relates to the protection of property.

 This symbol means read the operator's manual carefully before using the equipment. The operator's manual contains important information on the safe and proper operation of the equipment.

 This symbol means always wear safety glasses with side shields or goggles when handling or using this equipment to reduce the risk of eye injury.

 This symbol indicates the risk of hands, fingers or other body parts being caught, wrapped or crushed in the drain cleaning cable.

 This symbol indicates the risk of electrical shock.

 This symbol means always wear RIDGID drain cleaning mitts while operating drain cleaner.

 This symbol indicates the risk of entanglement in a belt and pulley.

General Power Tool Safety Warnings*

⚠ WARNING
Read all safety warnings, instructions, illustrations and specifications provided with this power tool. Failure to follow all instructions listed below may result in electric shock, fire, and/or serious injury.

SAVE ALL WARNINGS AND INSTRUCTIONS FOR FUTURE REFERENCE!

The term "power tool" in the warnings refers to your mains-operated (corded) power tool or battery-operated (cordless) power tool.

Work Area Safety

- **Keep work area clean and well lit.** Cluttered or dark areas invite accidents.
- **Do not operate power tools in explosive atmospheres, such as in the presence of flammable liquids, gases, or dust.** Power tools create sparks which may ignite the dust or fumes.
- **Keep children and by-standers away while operating a power tool.** Distractions can cause you to lose control.

Electrical Safety

- **Power tool plugs must match the outlet. Never modify the plug in any way. Do not use any adapter plugs with earthed (grounded) power tools.** Unmodified plugs and matching outlets will reduce risk of electric shock.
- **Avoid body contact with earthed or grounded surfaces such as pipes, radiators, ranges and refrigerators.** There is an increased risk of electrical shock if your body is earthed or grounded.
- **Do not expose power tools to rain or wet conditions.** Water entering a power tool will increase the risk of electrical shock.
- **Do not abuse the cord. Never use the cord for carrying, pulling or unplugging the power tool. Keep cord away from heat, oil, sharp edges or moving parts.** Damaged or entangled cords increase the risk of electric shock.
- **When operating a power tool outdoors, use an extension cord suitable for outdoor use.** Use of a cord suitable for outdoor use reduces the risk of electric shock.
- **If operating a power tool in a damp location is unavoidable, use a ground fault circuit interrupter**

* The text used in the General Power Tool Safety Warnings section of this manual is verbatim, as required, from the applicable UL/CSA/EN 62841-1 standard. This section contains general safety practices for many different types of power tools. Not every precaution applies to every tool, and some do not apply to this tool.

(GFCI) protected supply. Use of a GFCI reduces the risk of electric shock.

Personal Safety

- **Stay alert, watch what you are doing and use common sense when operating a power tool. Do not use a power tool while you are tired or under the influence of drugs, alcohol, or medication.** A moment of inattention while operating power tools may result in serious personal injury.
- **Use personal protective equipment. Always wear eye protection.** Protective equipment such as dust mask, non-skid safety shoes, hard hat, or hearing protection used for appropriate conditions will reduce personal injuries.
- **Prevent unintentional starting. Ensure the switch is in the OFF position before connecting to power source and/or battery pack, picking up or carrying the tool.** Carrying power tools with your finger on the switch or energizing power tools that have the switch ON invites accidents.
- **Remove any adjusting key or wrench before turning the power tool ON.** A wrench or a key left attached to a rotating part of the power tool may result in personal injury.
- **Do not overreach. Keep proper footing and balance at all times.** This enables better control of the power tool in unexpected situations.
- **Dress properly. Do not wear loose clothing or jewelry. Keep your hair, and clothing away from moving parts.** Loose clothes, jewelry, or long hair can be caught in moving parts.
- **If devices are provided for the connection of dust extraction and collection facilities, ensure these are connected and properly used.** Use of dust collection can reduce dust-related hazards.
- **Do not let familiarity gained from frequent use of tools allow you to become complacent and ignore tool safety principles.** A careless action can cause severe injury within a fraction of a second.

Power Tool Use and Care

- **Do not force power tool. Use the correct power tool for your application.** The correct power tool will do the job better and safer at the rate for which it is designed.
- **Do not use power tool if the switch does not turn it ON and OFF.** Any power tool that cannot be controlled with the switch is dangerous and must be repaired.

- **Disconnect the plug from the power source and/or the battery pack from the power tool before making any adjustments, changing accessories, or storing power tools.** Such preventive safety measures reduce the risk of starting the power tool accidentally.
- **Store idle power tools out of the reach of children and do not allow persons unfamiliar with the power tool or these instructions to operate the tool.** Power tools are dangerous in the hands of untrained users.
- **Maintain power tools and accessories. Check for misalignment or binding of moving parts, breakage of parts and any other condition that may affect the power tool's operation. If damaged, have the power tool repaired before use.** Many accidents are caused by poorly maintained power tools.
- **Keep cutting tools sharp and clean.** Properly maintained cutting tools with sharp cutting edges are less likely to bind and are easier to control.
- **Use the power tool, accessories and tool bits etc. in accordance with these instructions, taking into account the working conditions and the work to be performed.** The use of the power tool for operations different from those intended could result in a hazardous situation.
- **Keep handles and grasping surfaces dry, clean and free from oil and grease.** Slippery handles and grasping surfaces do not allow for safe handling and control of the tool in unexpected situations.

Service

- **Have your power tool serviced by a qualified repair person using only identical replacement parts.** This will ensure that the safety of the power tool is maintained.

Specific Safety Information

⚠ WARNING

This section contains important safety information that is specific to this tool.

Read these precautions carefully before using the K-60SP Drain Cleaner to reduce the risk of electrical shock or other serious injury.

SAVE ALL WARNINGS AND INSTRUCTIONS FOR FUTURE REFERENCE!

Keep this manual with machine for use by the operator.

Drain Cleaner Safety

- **Before using the tool, test the ground fault circuit interrupter (GFCI) provided with the power supply cord to insure it is operating correctly.** A properly operating GFCI reduces the risk of electrical shock.
- **Only use extension cords that are protected by a GFCI.** The GFCI on the machine power cord will not prevent electrical shock from extension cords.
- **Only grasp the rotating cable with gloves recommended by the manufacturer.** Latex or loose fitting gloves or rags can become wrapped around the cable and may result in serious personal injury.
- **Do not allow the cutter to stop turning while the cable is turning.** This can overstress the cable and may cause twisting, kinking or breaking of the cable and may result in serious personal injury.
- **One person must control both the cable and switch.** If the cutter stops rotating, the operator must be able to turn the tool OFF to prevent the cable from twisting, kinking and breaking.
- **Use latex or rubber gloves inside the gloves recommended by the manufacturer, goggles, face shields, protective clothing, and respirator when chemicals, bacteria or other toxic or infectious substances are suspected to be in a drain line.** Drains may contain chemicals, bacteria and other substances that may cause burns, be toxic or infectious or may result in other serious personal injury.
- **Practice good hygiene. Do not eat or smoke while handling or operating the tool. After handling or operating drain cleaning equipment, use hot, soapy water to wash hands and other body parts exposed to drain contents.** This will help reduce the risk of health hazards due to exposure to toxic or infectious material.
- **Only use the drain cleaner for the recommended drain sizes.** Using the wrong size drain cleaner can lead to twisting, kinking or breaking of the cable and may result in personal injury.
- **Always use the rear guide hose while operating the tool and ensure the cable does not extend beyond the rear guide hose.** This prevents the cable from whipping which may result in entanglement and personal injury.
- **Keep mitt-covered hand on the cable whenever the machine is running.** This provides better control of the cable and helps prevent twisting, kinking and breaking of the cable and may result in serious personal injury.
- **Position machine cable outlet within 2' (0.6 m) of the drain inlet or properly support exposed cable when the distance exceeds 2' (0.6 m).** Greater distances can cause control problems leading to twisting, kinking or breaking of the cable. Twisting, kinking or breaking cable may cause striking or crushing injuries.
- **One person must control both the cable and the clutch. Do not lock clutch handle during operation.** If the cutter stops rotating, the operator must be able to release the clutch to prevent twisting, kinking and breaking of the cable and reduce the risk of injury.
- **Do not operate the machine in REV (reverse) rotation except as described in this manual.** Operating in reverse can result in cable damage and is used to back the cable end out of blockages.
- **Do not wear loose clothing or jewelry. Keep your hair and clothing away from moving parts.** Loose clothing, jewelry or hair can be caught in moving parts.
- **Do not operate this machine if operator or machine is standing in water.** Operating machine while in water increases the risk of electrical shock.
- **Do not engage drain cleaner clutch (rotate cable) while any part of the cable is in the cable carrier.** This may cause striking or crushing injuries.
- **Do not use if there is the risk of contact with other utilities (such as natural gas or electric) during operation.** Visual inspection of the drain with a camera is a good practice. Crossbores, improperly placed utilities and damaged drains could allow the cutter to contact and damage the utility. This could cause electrical shock, gas leaks, fire, explosion or other serious damage or injury.
- **Read and understand these instructions and the instructions and warnings for all equipment and materials being used before operating this tool to reduce the risk of serious personal injury.**

RIDGID Contact Information

- If you have any question concerning this RIDGID® product:
- Contact your local RIDGID® distributor.

Description, Specifications and Standard Equipment

Description

The RIDGID® K-60SP is a portable Drain Cleaning Machine designed to clean 1 1/4" to 4" drain lines. Applications include laundry tubs, floor drains, roof vents and stack lines. Rear handle allows for transporting up ladders and cleaning roof-top vent stacks.

The machine is driven by a 1/2 HP motor that has a grounded electrical system. An integral Ground Fault Interrupter (GFCI) is built into the line cord. A toggle switch provides FOR/OFF/REVERSE control of the motor.

The K-60SP is designed to use sectional-type cable that has a quick change coupling system for disconnecting tools. The cable is manually fed in and out of the drain and rotates at a speed of 600 RPM. The rotation of the cable is controlled by a clutch handle. The cable stops instantly when the clutch handle is released. An adjustment knob allows the K-60SP to use both 5/8" and 7/8" sectional cable.

Specifications

Line Capacity Depends on choice of cable.
Refer to the following chart for recommendations.

Recommended Line Size and Reach

Cable Size	Line Size	Reach
5/8" Cable	1 1/4 - 4	125'
7/8" Cable	2 - 4	150'

Cable Sizes 7/8" and 5/8" sectional

Cable Speed 600 rpm

Motor

Type 115V/60 Hz, Reversible

Rating 1/2 HP

Amps 7

Weight 43 lbs. (19,5 kgs.)

Dimensions:

Length 18.0" (450mm)

Width 9.5" (240mm)

Height 14.0" (356mm)

Sound Pressure (L_{PA})* 68.7 dB(A), K=3

Sound Power (L_{WA})* 76.6 dB(A), K=3

* Sound measurements are measured in accordance with a standardized test per Standard EN 62841-1.

- Sound emissions may vary due to your location and specific use of these tools.
- Daily exposure levels for sound need to be evaluated for each application and appropriate safety measures taken when needed. Evaluation of exposure levels should consider the time a tool is switched off and not in use. This may significantly reduce the exposure level over the total working period.

Standard Equipment

Model No.	Description
K-60SP	K-60SP Sectional Machine 115 volts/60 Hz includes: A-1 Operator's Mitt A-60-12 Rear Guide Hose



Figure 1 – K-60SP Drain Cleaner

K-60SP-SE	K-60SP as above, plus: A-61 Tool Kit: – T-101 Straight Auger – T-102 Funnel Auger – T-107 Spade Cutter – T-125 Retrieving Auger – T-150-1 Sharktooth Cutter – A-3 Tool Box – A-12 Pin Key A-62 Cable Kit: – Five Sections C-10, 7/8" x15' Cable – A-8 Cable Carrier
-----------------	---



Figure 2 – K-60SP-SE Drain Cleaner

Machine Inspection

⚠ WARNING

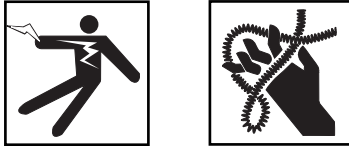

To prevent serious injury, inspect your Drain Cleaning Machine. The following inspection procedures should be performed before each use.

1. Make sure the Drain Cleaning Machine is unplugged and the directional switch is set to the **OFF** position (Figure 3).
2. Inspect the power cord, Ground Fault Circuit Interrupter (GFCI) and plug for damage. If the plug has been modified, is missing the grounding prong or if the cord is damaged, do not use the Drain Cleaning Machine until the cord has been replaced.

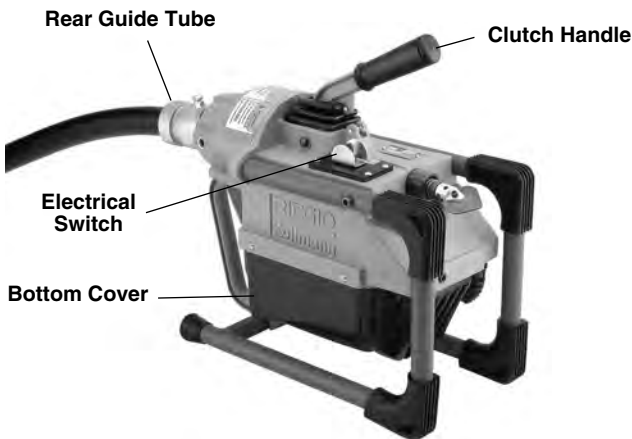

Figure 3 – K-60SP Drain Cleaner

3. Check bottom cover to insure it is properly fastened to the frame.

⚠ WARNING Do not operate this machine without the bottom cover attached. Fingers can be caught in rotating parts.

4. Inspect the Drain Cleaning Machine for any broken, missing, misaligned or binding parts as well as any other conditions which may affect the safe and normal operation of the machine. If any of these conditions are present, do not use the Drain Cleaning Machine until any problem has been repaired.
5. Lubricate the Drain Cleaning Machine, if necessary, according to the Maintenance Instructions.
6. Use tools and accessories that are designed for your drain cleaner and meet the needs of your application. The correct tools and accessories allow you to do the

job successfully and safely. Accessories suitable for use with other equipment may be hazardous when used with this drain cleaner.

7. Clean any oil, grease or dirt from all equipment handles and controls. This reduces the risk of injury due to a tool or control slipping from your grip.
8. Inspect the cutting edges of your tools. If necessary, have them sharpened or replaced prior to using the Drain Cleaning Machine. Dull or damaged cutting tools can lead to binding and cable breakage.
9. Inspect cables and couplings for wear and damage. Cables should be replaced when they become severely worn or corroded. A worn cable can be identified when the outside coils become flat.

⚠ WARNING Worn or damaged cables can break causing serious injury.

Machine Set-Up

⚠ WARNING



Do not place machine in water. Water entering the motor can result in electrical shock.

To prevent serious injury, proper set-up of the machine and work area is required. The following procedures should be followed to set-up the machine:

1. Check work area for:
 - Adequate lighting
 - Grounded electrical outlet
 - Clear path to the electrical outlet that does not contain any sources of heat or oil, sharp edges or moving parts that may damage electrical cord.
 - Dry place for machine and operator. Do not use the machine while standing in water.
 - Flammable liquids, vapors or dust that may ignite.
2. Position the Drain Cleaning Machine within 2' of sewer inlet. Greater distance can result in cable twisting or kinking.
3. Remove the pin key from the clutch handle. With pin key removed, handle should be in its upper-most position.

NOTE! When not in use, the clutch handle should be in its locked (down) position in order to protect the handle and to allow the operator to carry the unit by the clutch handle if desired.

4. Make sure FOR/OFF/REV switch is in the **OFF** position.



Figure 4 – Rear Guide Hose Attachment

5. Attach the rear guide hose by lifting up the lock pin and sliding guide hose onto the jaw housing adjustment knob (Figure 4).

⚠ WARNING Do not use machine without rear guide hose attached. Prevents cable whipping and possible entanglement.

6. Insert first cable into front of machine (female end first) and push through guide hose until approximately one foot remains out the front of the machine (Figure 5).



Figure 5 – Inserting Cable Into Front Of Machine

⚠ WARNING Never couple more than one cable at a time. Cable will extend behind rear guide tube.

NOTE! Adjust the jaw set as required. The K-60SP has a jaw set adjustment which allows the machine to accept 5/8" and 7/8" diameter cable. Refer to "Special Procedures" section.

7. Select and install the proper tool to the end of the cable. The T-Slot Coupler allows the tool to be snapped into the cable coupler (Figure 6). To remove tool, use the pin key to depress the plunger and slide the coupling apart.

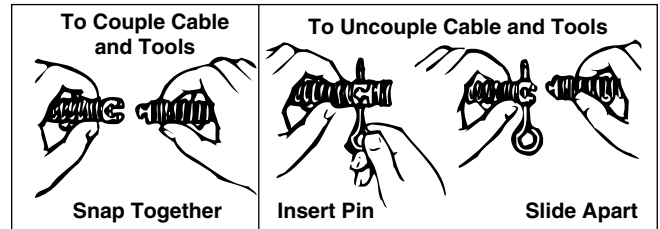

Figure 6 – Coupling and Uncoupling Tools

NOTE! Proper Tool Selection

A good rule of thumb is to use a tool at least 1" smaller than the line to be cleaned. The style of the tool is determined by the nature of the job and is left up to the operator.

8. Plug the Drain Cleaning Machine into the electrical outlet, making sure to position the power cord along the clear path selected earlier. If the power cord does not reach the outlet, use an extension cord in good condition.

⚠ WARNING To avoid electric shock and electrical fires, never use an extension cord that is damaged or does not meet the following requirements:

- The cord has a three-prong plug similar to shown in Electrical Safety section.
- The cord is rated as "W" or "W-A" if being used outdoors.
- The cord has sufficient wire thickness (16 AWG below 50'/14 AWG 50' - 100'). If the wire thickness is too small, the cord may overheat, melting the cord's insulation or causing nearby objects to ignite.

⚠ WARNING To reduce risk of electrical shock, keep all electrical connections dry and off the ground. Do not touch plug with wet hands. Test the Ground Fault Circuit Interrupter (GFCI) provided with the electric cord to insure it is operating correctly. When test button is pushed in, the indicator light should go off. Reactivate by pushing the reset button in. If indicator light goes on, the machine is ready to use. If the GFCI does not function correctly, do not use the machine.

Operating Instructions

⚠ WARNING

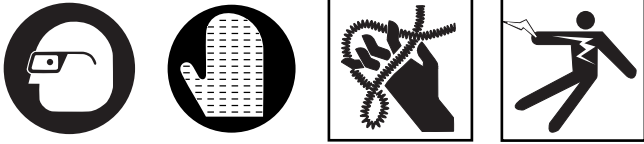

Wear mitts with rivets provided with machine. Never grasp a rotating cable with a rag or loose fitting cloth that may become wrapped around the cable causing serious injury.

Always wear eye protection to protect your eyes against dirt and other foreign objects. Wear rubber soled, non-slip shoes.

Be very careful when cleaning drains where cleaning compounds have been used. Wear gloves when handling cable and avoid direct contact to the skin and especially the eyes and facial area as serious burns can result.

Do not operate with clutch handle locked in place. Clutch is a safety feature designed to stop rotation of cable when released.

CAUTION It is very important to know approximate distance from inlet to main sewer or septic tank. Over-running cable too far into main sewer or septic tank can cause cables to knot up and prevent their return through small line.

1. Assume the correct operating posture in order to maintain proper balance (*Figure 7*).

⚠ WARNING Should an unexpected situation arise, this posture provides you with the opportunity to safely keep control of the machine and cable.

- Be sure you can quickly release the clutch handle.
- Hand must be on the cable to control its twisting action when it hits an obstruction.
- Must have access to FOR/OFF/REVERSE switch.



Figure 7 – Proper Operating Position

2. Pull sufficient cable out of the machine to start tool and

cable into the sewer inlet. If going through a “P” trap, push cable into inlet as far as it will go.

3. Pull enough extra cable through machine to form almost a half circle between machine and line opening.
4. Hold cable loosely in mitted hand. Put FOR/OFF/REVERSE switch in FOR (forward) position.

NOTE! The motor will start but cable will not rotate.

5. With mitted hand on cable, push down on clutch handle with opposite hand to engage cable. Push down on top of the cable loop with a definite snap to advance the cable.

NOTE! A slow or gradual engaging of the clutch handle causes excessive wear of the jaw set. The clutch is instant-acting and returning clutch handle to its original position frees cable instantly.

6. As soon as excess cable has gone into line, release clutch handle and pull six to ten inches of cable out of machine with mitted hand.
7. Continue to feed the cable into the line until resistance or obstruction is encountered. This will become apparent to operator as it will be difficult to feed additional cable into line and/or the cable will have a tendency to twist sideways in operator’s hands.
8. If cable loads down in the obstruction, relieve load by pulling back on cable with short, quick jerks to free cutter. Slowly advance cable back into the obstruction. Repeat this process until the obstruction is clear. Remember, make sure the cutter is rotating at all times and never force the cable. At this point, progress depends upon the sharpness of the tool and nature of the obstruction.

⚠ WARNING

Do not allow tension to build up in the cable. This will happen if the cutting tool hits a snag and stops turning, but the motor and cable continue to rotate. Torque builds until the cable suddenly twists, potentially wrapping around your hand or arm. This can happen quickly and without warning, so proceed slowly and carefully as you feed the cable into the drain. Releasing clutch handle will stop the cable rotating and releases the torque. If tool gets hung up in an obstruction, refer to Reverse Operating Instructions in the “Special Procedures” section.

9. Once obstruction is cleared, it is recommended that operator flush debris from line with running water. Repeat *Step 8* several times if necessary for thorough cleaning job and then work cable through additional stoppages as required.

10. To add cable, the following procedure should be followed:

- After reaching the end of each cable section, turn the machine OFF.
- Secure the cable by looping it in the line (*Figure 8*). This procedure is especially useful when cleaning a line has a large slope.

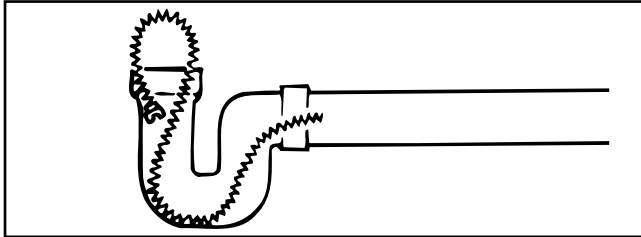

Figure 8 – Looping Cable In Line

- With line secured, insert another section of cable in through the front of the machine (female end first) until approximately one foot remains out the front of the machine.
 - Attach cable to cable in line and resume operation.
11. To retrieve cable from drain line, the following procedure should be followed:

- Leave FOR/OFF/REV switch in FOR (forward) position.
- Push down on clutch handle to engage cable. With mitted hand pull cable out of line (if possible) or hold cable against edge of inlet to thread the cable out until loop forms in front of the machine.

NOTE! By holding the cable against the edge of the inlet, the rotation will rapidly “thread” the cable out of the line.

- When loop forms, release clutch handle and push excess cable back through machine. Disconnect one section at a time.

⚠ WARNING When disconnecting sections, remember to turn unit off and secure cable in line.

- Once section of cable is removed, insert the secured cable in through the front of the machine and continue removing sections until tool on last section of cable is just inside sewer inlet.

⚠ WARNING Never retract tool from sewer inlet while cable is rotating. Tool can whip causing serious injury.

12. Turn FOR/OFF/REV Switch to OFF position and remove cord from power source.

13. Pull remaining cable and tool from sewer.

CAUTION After using, thoroughly flush and drain cables, couplings and tools with water due to damaging effects of some drain cleaning compounds.

Special Procedures

Reverse Operation

Running machine in reverse will cause premature failure of cable. Use reverse only to free a tool caught in an obstruction. If this should occur, immediately release clutch handle and place FOR/OFF/REV switch to OFF position. After motor comes to a complete stop, place FOR/OFF/REV switch in the REV (reverse) direction. Engage clutch handle only until tool is free of obstruction. Once tool is free, release clutch handle immediately. turn unit OFF. Run unit in FOR (forward) direction and follow normal operating procedure.

⚠ WARNING Never operate this machine in REV (reverse) for any other purpose. Operating in reverse can damage a cable and cause serious injury.

Jaw Set Adjustment

$\frac{7}{8}$ " Diameter Cable

- If $\frac{7}{8}$ " cable will not slide through the front of the machine, the jaw set is not open wide enough.
- Remove the rear guide hose from the jaw housing adjustment knob.
- Loosen the adjustment knob set screw with $\frac{1}{4}$ " hex key (*Figure 9*).
- Turn the Adjustment Knob counter-clockwise when viewed from the rear (approximately 2 turns) until the cable will slide through the machine (*Figure 10*).
- With cable through the jaw set, press the clutch handle DOWN to make sure the jaw set engages the cable. If not, turn the knob clockwise until there is engagement.
- If necessary, turn the adjustment knob in the direction required so that the clutch handle engages the cable at the position desired by the operator.



Figure 9 – Loosen the Set Screw

- Tighten the set screw.
- Reattach the rear guide hose.



Figure 10 – Jaw Set Adjustment

5/8" Diameter Cable

- If the jaw set does not engage the cable when the clutch handle is pressed, the jaw set is open too wide.
- Remove the rear guide hose from the jaw housing adjustment knob.
- Loosen the set screw with 1/4" hex key (Figure 9).
- Turn the adjustment knob clockwise until the cable is engaged by the jaw set when the clutch handle is pressed (approximately 2 turns) (Figure 10).
- If necessary, turn the adjustment knob in the direction required so that the clutch handle engages the cable at the position desired by the operator.
- Tighten the set screw.
- Reattach the rear guide hose.

Accessories

⚠ WARNING Only the following RIDGID products have been designed to function with the K-60SP Drain Cleaning Machine. Other accessories suitable for use with other tools may become hazardous when used on the K-60SP. To prevent serious injury, use only the recommended accessories.

NOTE! See Ridge Tool Catalog for complete list of tools and accessories.

Cable Selection Chart

Model	Length	Size/Type	Typical Application	Characteristics
C-7	7 1/2'	5/8" (16mm)	2" & 3" Floor drains	Tight wind cable providing good rigidity in a hollow core cable. Not recommended for tree roots.
C-8	7 1/2'	5/8" (16mm)	Drain Lines 1 1/4" – 2". Ideal for proper cleaning of small lines	Open wind cable that is more flexible than C-7. Open wind acts as an auger to thoroughly remove blockages in small lines.
C-9	10'	5/8" (16mm)	Drain Lines 2" – 4". Ideal for drains and stacks	Heavy-duty open wind cable ideal for long runs in indoor lines.
C-10	15'	7/8" (22mm)	Drain Lines 2" – 4". Roof-top vent stacks	Standard all-purpose open wind. Excellent flexibility.

7/8" Cable and Leader

Catalog No.	Model No.	Description
62275 30007	C-10 T-127	15' All-Purpose Wind (4.6m) 7/8" Trap Leader

5/8" Cables

Catalog No.	Model No.	Description
51317	C-9	10' Heavy-Duty (3m)
62270	C-8	7 1/2' All-Purpose Wind (2.3m)
62265	C-7	7 1/2' Tight-Wind (2.3m)

Cable Kits and Tool Kit

Catalog No.	Model No.	Description
61630	A-62	Standard Equipment Cable Kit for K-60SP-SE, includes: – Five Sections C-10, 7/8" x 15' Cable (75', 23m) – A-8 Cable Carrier
61625	A-61	Standard Equipment Tool Kit for K-60SP-SE includes: – T-101 Straight Auger – T-102 Funnel Auger – T-107 Spade Cutter – T-125 Retrieving Auger – T-150-1 Sharktooth Cutter – A-3 Tool Box – A-12 Pin Key
48472	A-35	5/8" Cable Kit, includes: – Six Sections C-8, 5/8" x 7 1/2" Cable (45', 14m) – A-10 Cable Carrier – T-201 Straight Auger – T-202 Bulb Auger – T-205 "C" Cutter – T-211 Spade Cutter – A-13 Coupling Pin Key
48477	A-35TW	5/8" Tight-Wind Cable Kit, substitutes C-7 for C-8 in above package

Tools for C-10 Cable

Catalog No.	Model No.	Description
62850	T-101	Straight Auger
62855	T-102	Funnel Auger
27642	T-125	Retrieving Auger
62860	T-103	Sawtooth Cutter, 2 1/2"
62865	T-104	"H" Cutter, 2 1/2"
62870	T-105	Grease Cutter, 2 1/2"
62875	T-106	Grease Cutter, 3 1/2"
62880	T-107	Spade Cutter, 1 3/4"
62915	T-109	Spiral Sawtooth Cutter, 1 3/4"
62920	T-110	Spiral Sawtooth Cutter, 2 1/4"
62925	T-111	Spiral Sawtooth Cutter, 3"
62930	T-112	4-Blade Cutter, 1 3/4"
62935	T-113	4-Blade Cutter, 3"
98050	T-150	Sharktooth Cutter, 3" and 4"
98055	T-150-1	Sharktooth Cutter, 3" Blade
98060	T-150-2	Sharktooth Cutter, 4" Blade
62940	T-114	Chain Knocker

Tools for C-7, C-8, and C-9 Cables

Catalog No.	Model No.	Description
62990	T-201	Straight Auger
62995	T-202	Bulb Auger, 1 1/8" O.D.
63000	T-203	Bulb Auger, 7/8", O.D.
55457	T-225	Retrieving Auger
63065	T-217	Drop Head
54837	T-204	"C" Cutter, 1"
63005	T-205	"C" Cutter, 1 3/8"
63010	T-206	Funnel Auger
63015	T-207	Spiral Cutter, 1 1/4"
63020	T-208	Spiral Cutter, 1 1/2"
63025	T-209	Spiral Cutter, 2"
63030	T-210	Spade Cutter, 1"
63035	T-211	Spade Cutter, 1 3/8"
63040	T-212	Spade Cutter, 1 3/4"
63045	T-213	4-Blade Cutter, 1"
63050	T-214	4-Blade Cutter, 1 3/8"
63055	T-215	4-Blade Cutter, 1 3/4"
63060	T-216	Chain Knocker, 2"
63280	T-218	Flue Brush, 3"
63070	T-219	Flue Brush, 2 1/2"
63080	T-220	Flue Brush, 2"
63220	T-221	Flue Brush, 1 1/2"
52812	T-230	H-D "C" Cutter, 2"
52817	T-231	H-D "C" Cutter, 2 1/2"
52822	T-232	H-D "C" Cutter, 3"
48482	T-250	Tool Set includes: - T-203 - T-217 - T-205 - A-13 - T-210

Miscellaneous

Catalog No.	Model No.	Description
59360	A-3	Tool Box
59205	A-1	Left-Hand Mitt
59295	A-2	Right-Hand Mitt
59225	A-12	Pin Key, 7/8" Cable
59230	A-13	Pin Key, 5/8" Cable
61615	A-60-12	12' Rear Guide Hose for 7/8" Cable/C-10
59235	A-14-6	6' Rear Guide Hose for 5/8" Cable/C-7, C-8, C-9
84325	A-14-10	10' Rear Guide Hose for 5/8" Cable/C-7, C-8, C-9
59470	A-8	Cable Carrier (Holds 75' 7/8" Cable/C-10)
59210	A-10	Cable Carrier (Holds 45' 7/8" Cable/C-10)
		Cable Carrier (Holds 90' 5/8" Cable/C-8, C-9)
59425	A-36	Cable Caddy
65687		K-60SP Jaw Set

NOTE! See Ridge Tool Catalog for complete list of tools and accessories.

Maintenance Instructions

⚠ WARNING

Make sure machine is unplugged from power source before performing maintenance or making any adjustment.

Lubrication

Lubricate machine with grease at grease fitting (located on jaw housing) once a week if used every day; once a month if used less.

NOTE! No lubrication of the Motor Shaft is required.

Cables

Cables should be thoroughly flushed with water to prevent damaging effects of drain cleaning compounds. Periodically lubricate cables and couplings with RIDGID Cable Rust Inhibitor.

When not in use, store cables indoors to prevent deterioration by the elements.

Cables should be replaced when they become severely corroded or worn. A worn cable can be identified when outside of coils become flat.

Clutch Jaw Assembly (Jaw Set)

The clutch jaw assembly should be periodically cleaned.

1. Stand the machine up on the front of the frame. Make sure clutch handle is in its uppermost position. Remove the two (2) socket head cap screws from the jaw housing with a 1/4" hex key (Figure 11).



Figure 11 – Remove Socket Head Cap Screws

2. Remove the jaw housing. The clutch jaw assembly is contained in the jaw housing.
3. Remove the jaw set cover by rotating counter-clockwise (*Figure 12*).



Figure 12 – Remove Jaw Set Cover

4. Clean the clutch jaw assembly, jaw cover, and the inside of the jaw housing.
5. If worn, replace the clutch jaw assembly.
6. Reinstall the jaws into the jaw housing and replace the jaw set cover.

7. Rotate the adjustment knob clockwise until the jaw set touches the jaw set cover. This will insure that the jaw set is properly aligned.

8. Attach jaw housing to machine with socket head cap screws.

NOTE! Make sure flanges on plastic shroud are contained inside the jaw housing.

Drive Belt Replacement

1. Stand the machine up on the front of the frame. Make sure clutch handle is in its uppermost position. Remove the two (2) socket head cap screws from the jaw housing with a $1/4$ " hex key. (*Figure 11*)
2. Remove the jaw housing.
3. Loosen the jam nut on the side of the machine (*Figure 13*).
4. Rotate motor adjustment set screw counter-clockwise with $3/16$ " hex key until belt is loose enough to be removed.

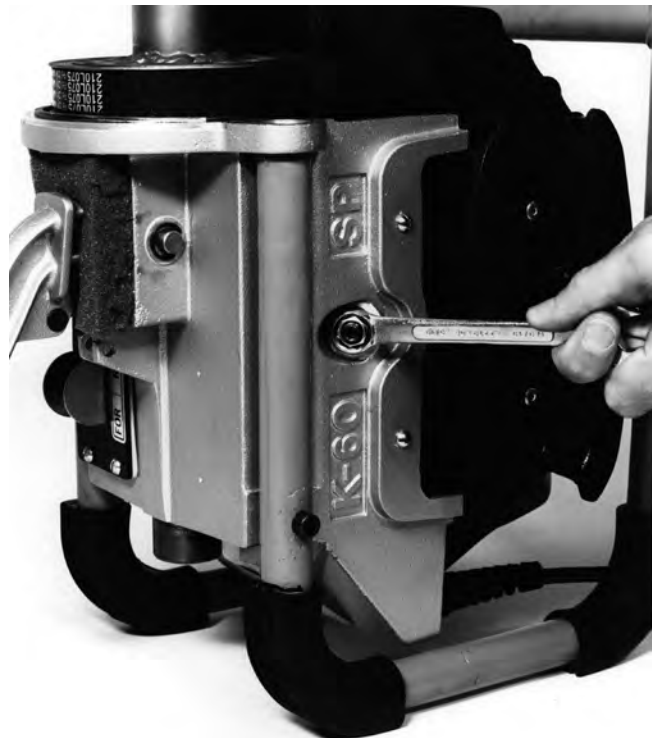

Figure 13 – Loosen Jam Nut

5. Install new belt and set unit down on bottom of frame (operating position), so belt will become tensioned by the weight of the motor.
6. Rotate the motor adjustment set screw until it just touches the motor. Once the set screw touches motor, rotate set screw $1/2$ turn clockwise.

NOTE! Do not tighten this set screw by driving it into the motor.

7. While holding the set screw in place with the $\frac{3}{16}$ " hex key, tighten the jam nut (Figure 14).



Figure 14 – Tighten Jam Nut

8. Attach jaw housing to machine with socket head cap screws.

Machine Storage

⚠ WARNING Motor-driven equipment must be kept indoors or well covered in rainy weather. Store the machine in a locked area that is out of reach of children and people unfamiliar with drain cleaners. This machine can cause serious injury in the hands of untrained users.

If machine has been exposed to freezing weather, unit must be run for ten (10) to twenty (20) minutes without load to warm up. Failing to do this will result in frozen bearings. If machine is exposed to weather for a period of time, moisture will form across motor windings causing motor to burn out.

Service and Repair

⚠ WARNING



The "Maintenance Instructions" will take care of most of the service needs of this machine. Any problems not ad-

ressed by this section should only be handled by an authorized RIDGID service technician.

Tool should be taken to a RIDGID Independent Authorized Service Center or returned to the factory. All repairs made by Ridge service facilities are warranted against defects in material and workmanship.

⚠ WARNING When servicing this machine, only identical replacement parts should be used. Failure to follow these instructions may create a risk of electrical shock or other serious injury.

If you have any questions regarding the service or repair of this machine, call or write to:

Wiring Diagram

115V/60 Hz

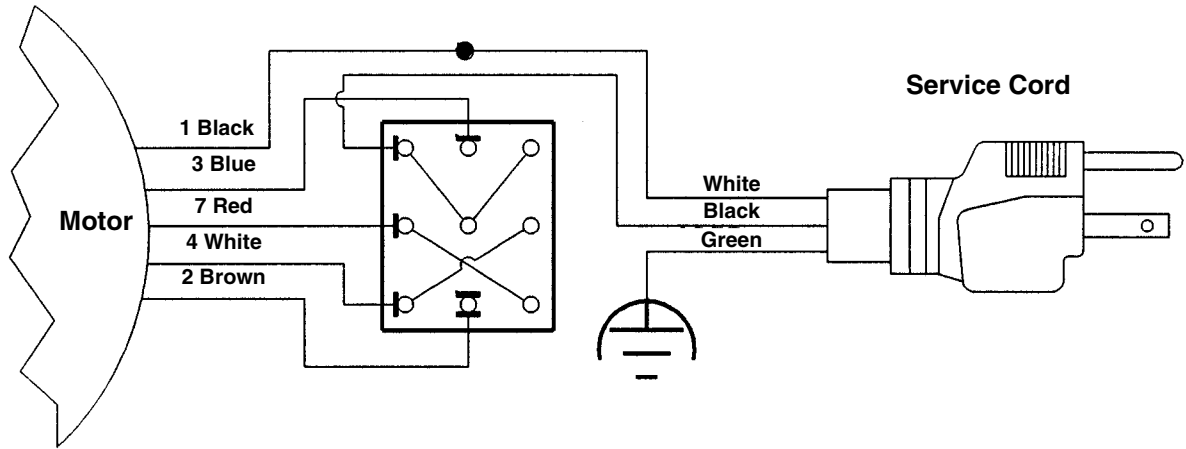

230V/50 Hz

