

# Combustion Efficiency Analyzer

## 707

Rev. 6.x Analyzers



The Value Leader™

## Contents

Introduction.....	1
General Overview.....	1, 2
Instrument Overview.....	3 ~ 7
Front View.....	3
Keypad.....	4
Back View.....	5
Side Views.....	6
Top View.....	7
Basic Analyzer Functions.....	8, 9
Analyzer Batteries.....	8
Turning The Analyzer On & Fuel Selection.....	8, 9
Turning The Analyzer Off.....	9
Activating The Backlight.....	9
Carbon Monoxide Analysis Overview.....	10
Testing for Carbon Monoxide in Ambient Air.....	11, 12
Acceptable Levels of CO in Ambient Air.....	12
Testing for Carbon Monoxide in Flues and Appliances.....	13 ~ 21
Typical Test Locations.....	15 ~ 18
Typical Test Results.....	21
Setting Date & Time.....	22
Storing Data.....	23
Recalling Data.....	24
Printing Data.....	25, 26
Specifications.....	27
Calibration & Service.....	28
Warranty.....	28
Appendix A	General Maintenance & Function Tests.....29- 31
Appendix B	A773 Sulfur Filter Installation & Maintenance....32, 33
Appendix C	Error Codes and Troubleshooting..... 34
Appendix D	CO Alarm & Auto Power Off.....35
Appendix E	Manually Initializing Sensors.....36
Appendix F	Carbon Monoxide Facts.....37
Appendix G	Carbon Monoxide Limits in Ambient Air Chart....38
Appendix H	Battery Replacement.....39

## Introduction

Thank you for purchasing TPI brand products. The TPI 707 Carbon Monoxide Analyzer is a state of the art, easy to use analyzer designed to display carbon monoxide levels in and around appliances and work / living spaces. The instrument is ruggedly constructed and comes with a 3 Year unit and 2 Year sensor Guarantee.

## General Overview

The TPI 707 combustion analyzer uses a state of the art electrochemical sensor. This sensor technology provides the longest lasting, most accurate and reliable means for performing tests. The sensor in your analyzer will need to be replaced periodically and calibration is recommended once every year. The 707 will remind you when calibration is due by flashing "CAL DUE Err" for three seconds at start up if the date of calibration is one year or older.

Electrochemical sensors by nature are always active. Therefore the time the analyzer is off and not being used must be taken into account when determining sensor life. The sensor in your analyzer is warranted for two years. This warranty does not cover a sensor damaged through misuse of the analyzer.

You should keep the batteries of your 707 fresh so power is constantly being supplied to your sensor.

The following guidelines will help prevent damage to your sensor:

- Always use the mini pump filter when performing tests.
- Always periodically check and replace the mini pump filter as needed.
- Always make sure the in-line filter / water trap is installed properly.
- Always periodically check and replace the in-line filter as needed.
- Always remove water or condensation from the inside of the in-line filter / water trap assembly prior to performing tests.
- Always use the optional oil filter (p/n A773) when performing tests on oil burning equipment.

## General Overview (Continued)

Never over saturate your sensors by performing tests on equipment with gas levels beyond the capability of your analyzer.

Always keep the A794 water trap / filter assembly clean and replace the filter as necessary. Replacement filter part number is A794F.

This manual will guide you through the functions of the TPI 707 which will give you many years of reliable service.

Your TPI 707 Flue Gas Analyzer comes complete with the following standard accessories:

- TPI 707 Instrument
- Rubber Boot (A765)
- Soft Carrying Case (A787)
- Flue Sampling Probe (A69)
- In-Line Filter assembly installed on Flue probe (A794)
- Mini Pump Protection Filter Assembly and spare filters (A763)
- Exhaust Spigot (removable) (A764)
- Instruction Manual

( ) Denotes part number

Your TPI 707 Flue Gas Analyzer has the following options available:

- Infrared printer (A740)
- Spare In-Line Filter (A794F is a package of 5 filters)
- Spare Water Block Filter (A794W is a package of 1 filter)

## Instrument Overview









### Front View



<b>Rubber Boot</b>	Protects the instrument from accidental damage
<b>Display</b>	Large 3 Parameter Backlit LCD Display
<b>Battery Condition Icon</b>	Shows condition of batteries.
<b>Keypad</b>	Selects all available functions

**NOTE:** When performing tests on oil fired equipment be sure to use the optional oil filter (A773) or readings could become erratic. See Appendix E for installation instructions.

## Keypad

-  Turns the 707 On (hold button in for 2 seconds) and Off
-  Toggles between CO reading and Peak Reading. Used to save, recall and print stored data.
-  Used for setting date, time and accessing data storage addresses
-  Used for setting date, time and accessing data storage addresses
-  Used to recall previously stored data in one of 50 data storage addresses or the last calibration date.
-  Used to store data in one of 10 data storage addresses.
-  Used to select CO measurement or date/time in main display. Hold down for 2 seconds to activate LCD backlight.
-  Sends real time or stored data to the IR printer port. Also used to print the last calibration date.

## Back View

Connection for  
Mini Pump  
Protection Filter

Sample Inlet  
Port



Calibration and  
Information  
Label

Battery  
Compartment

### Sample Inlet Port:

Connection for Gas Sampling Probe  
(see pages 7 & 11)

Connection for Mini Pump Protection  
Filter (see pages 7 & 11)

**Calibration and Information Label:** Displays calibration information and  
Displays serial number

**Battery Compartment:** Holds "AA" batteries

## Side Views

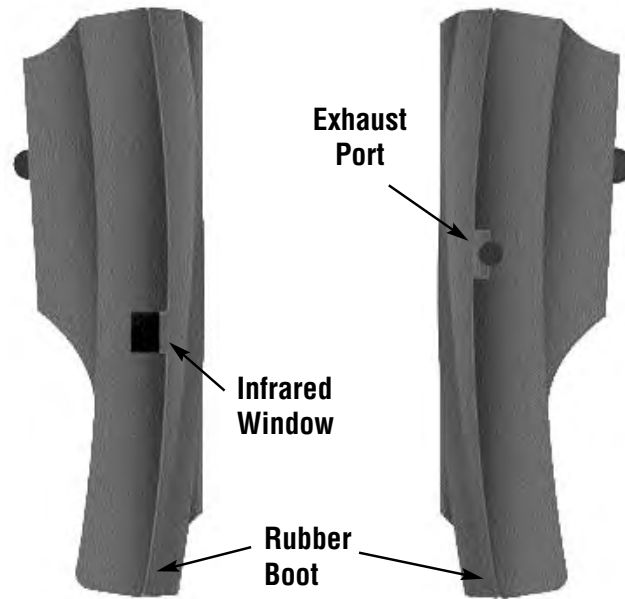

**Exhaust Port**

Port for connection of Exhaust Adapter

**Infrared Window**

Window for sending stored data to optional A740 IR Printer (see page 25 )

**Rubber Boot**

Protects the instrument from accidental damage



## Top View

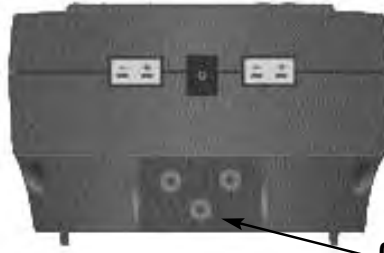

**Gas Sampling Port**





**Gas Sample Port** Connection for Mini Pump Protection Filter and Flue Probe (see pages 7 & 11)

## BASIC ANALYZER FUNCTIONS

### Analyzer Batteries

Your carbon monoxide analyzer is fitted with three AA size 1.5V batteries. It is important to keep battery power to the sensors in y even when it is not in use.

Your analyzer has a battery status indicator in the lower right c display. Battery status is determined as follows:

-  Indicates batteries are at full capacity.
-  Indicates batteries are at 2/3 capacity.
-  Indicates batteries are at 1/3 capacity. Replacement o should be considered soon.
-  Indicates batteries are very low and in need of replac immediately. See Appendix H for battery replacement

### Turning The Analyzer On

**Always: - Before turning on please ensure that the Mini Pum Filter assembly the Tubing & In-Line Filter are not connecte Sample Port (see page 7)**

The instrument MUST be turned on in a clean air environment purge will set the Carbon Monoxide level to Zero. Press and hc Power Key and the TPI 707 will start its 30 second countdown be displayed.

*After start up, several tests can be performed to ensure proper the analyzer and flue probe. Please refer to Appendix A.*

After the 30 second countdown the instrument is ready to take monoxide readings.

The 707 will auto power off if no keys have been pressed for 1 the CO level is below 15ppm. Auto off can be disabled (see Ap auto power off feature is always enabled upon power up.

## Turning The Analyzer Off

Always: - Before turning off return the instrument to a clean air environment and allow the Carbon Monoxide level to return to below 15ppm. Press the Power Key to turn the instrument off:- NOTE Should you attempt to turn the instrument Off and the CO reading is above 15ppm then the instrument will remain On and a short Beep will be heard. The Instrument can only be switched off if the CO is below 15ppm

The instrument has an auto shut off after 10 minutes should no keys have been pressed for this period and as mentioned above that the CO is below 15ppm. Should the CO be above 15ppm then the 10 minute auto shut off countdown will not begin till the CO has gone below 15ppm. The auto power off feature can be disabled. Please see Appendix D. The auto power off feature is always enabled upon power up.

## Activating the Backlight

The display backlight can be activated at any time by pressing and holding down the Func Key for approximately 2 seconds. The backlight will automatically shut off after approximately 20 seconds to preserve battery life.

## Carbon Monoxide Analysis Overview

Performing carbon monoxide analysis is very important to the overall safety of heating equipment and appliances. The following guidelines and descriptions are generic and meant to provide you with a basic understanding of testing. TPI always recommends you contact the manufacturer of the device under test, obtain information specific to the device, and follow the procedures and safety guidelines for performing tests and affecting repairs.

In general, for most applications, flue gas samples should be taken prior to the draft diverter or any other opening that allows room air to enter the system. This prevents room air from mixing with gases in the flue and diluting the test sample.

Prior to taking a sample, the device under test should be on and operating. Putting the flue probe in the sample area prior to starting the device may cause saturation of the sensors due to the higher initial concentration of carbon monoxide that may be encountered upon start up. If this happens, allow your analyzer to purge in fresh air until the carbon monoxide level returns to 0 ppm. This may take more than an hour depending on how saturated the sensor is.

The figures on pages 15 through 18 show locations for performing tests on commonly encountered equipment. Remember to consult with the manufacturer of the device under test for specific test information.

**NOTE:** Your 707 carbon monoxide analyzer is equipped with a high quality sensor that incorporates an on-board NO/NOx filter. This filter prevents higher than normal CO readings caused by sensor cross sensitivity to NO/NOx, which is a byproduct of combustion.

**When a gas appliance or hot water heater is operating properly, little or no CO will be produced. Older CO analyzers, and those equipped with sensors that do not have an on-board filter, will incorrectly read higher levels of CO because of the “NOx bump” or cross sensitivity to the NO/NOx present in the sample.**

**The NO/NOx cross sensitivity can increase the displayed reading by as much as 30ppm or more on analyzers with sensors that do not have the NO/NOx filter.**

## Testing for Carbon Monoxide in Ambient Air

*Note: It is recommended you perform routine general maintenance on your analyzer to ensure proper function. Please refer to Appendix A for general maintenance schedule and function tests.*

1. Turn the 707 on in fresh air as outlined on page 8. After the initial purge cycle the 707 will display the screen below.
2. After the purge cycle is complete the carbon monoxide level will be seen. Please see below.



- **Carbon Monoxide Display (Real Time)**
- Displays Carbon Monoxide (CO) reading in parts per million (ppm)

3. Connect the Mini Pump Protection filter to the analyzer. See picture below.

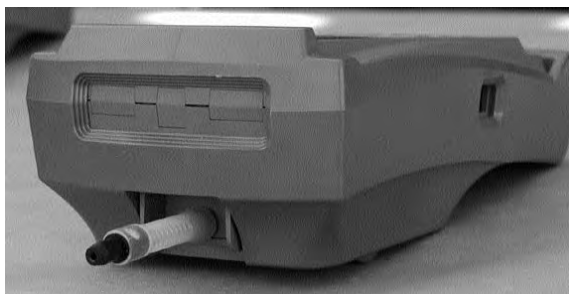

4. Begin testing for carbon monoxide. Move from space to space to detect any CO that may be present. The CO reading will be seen in the top part of the display.
5. If necessary, the flue probe can be attached to test in ducts and plenums.
6. Refer to the chart on the next page for a list of exposure times and levels of carbon monoxide in ambient test applications.
7. If necessary, the Scroll/Enter key can be pressed to display the peak CO measured since the 707 was turned on. Pressing and holding down the Down Arrow key will zero the peak reading. Pressing the Scroll/Enter key again will return the 707 to normal operation.
8. When testing is complete, turn the analyzer off as outlined on page 9.

## Carbon Monoxide in Ambient Air Chart

This chart contains maximum exposure levels and times for carbon monoxide. This is a general guideline only. It is recommended you check with your local government for guidelines in your area.

### CARBON MONOXIDE the SILENT KILLER!

<i>Concentration of CO in air</i>	<i>Exposure times and toxic symptoms</i>
<b>9ppm</b>	The maximum allowable concentration for short term exposure in a living area according to ASHRAE
<b>35ppm</b>	The maximum allowable concentration for continuous exposure in any 8 hour period, according to federal law. (US federal law)
<b>200ppm*</b>	Maximum concentration allowable any time according to OSHA. Slight headaches, fatigue, dizziness, nausea after 2-3 hours.
<b>400ppm*</b>	Frontal headaches within 1-2 hours, life threatening after 3 hours. Maximum allowable limit in flue gas according to EPA and AGA.
<b>800ppm*</b>	Headache, dizziness, nausea, and convulsions with 45 minutes. Unconsciousness within 2 hours. Death within 2-3 minutes.
<b>1600ppm*</b>	Headache, dizziness, and nausea within 20 minutes. Death within 1 hour.
<b>3200ppm*</b>	Headache, dizziness, and nausea within 5-10 minutes. Death within 30 minutes.
<b>6400ppm*</b>	Headache, dizziness, and nausea within 1-2 minutes. Death within 10-15 minutes.
<b>12800ppm*</b>	Death within 1-3 minutes.

## Testing for Carbon Monoxide in Flues & Appliances

*Note: It is recommended you perform routine general maintenance on your analyzer to ensure proper function. Please refer to Appendix A for general maintenance schedule and function tests.*

1. Turn the 707 on in fresh air as outlined on page 8. After the initial purge cycle the 707 will display the screen below.



- **Carbon Monoxide Display (Real Time)**
- Displays Carbon Monoxide (CO) reading in parts per million (ppm)

2. Connect the Mini Pump Protection Filter assembly and Flue Probe to the Gas Sample Port. (See below & page 7)



**IMPORTANT:** Prior to taking a sample, the device under test should be on and at operating temperature. **Putting the flue probe in the sample area prior to starting the device may cause saturation of the sensors due to the higher initial concentration of carbon monoxide that may be encountered upon start up.** If this happens, allow your analyzer to purge in fresh air until the carbon monoxide level returns to 0 ppm. This may take more than an hour depending on how saturated the sensors are.

3. For testing in a flue, drill a 1/4 inch hole into the flue of the device under test. For most applications, flue gas samples should be taken prior to the draft diverter or any other opening that allows room air to enter the system. This prevents room air from mixing with gases in the flue and diluting the test sample.

**Note:** If performing a test on a hot water heater insert the probe directly down into the top of the water heater exhaust tube (fire tube). Measuring in the gap between the hood and the exhaust pipe will not provide an accurate reading due to dilution of the sample. Please see the figure on page

***It is important to use manufacturers recommended test locations whenever possible.***

Refer to the figure below for calculating the sample hole location.

Flue pipe diameter x 1.5 = proper hole location

***Example for a 4 inch flue:***

4 inches x 1.5 = 6 inches

The hole should be drilled 6 inches above the furnace exhaust.

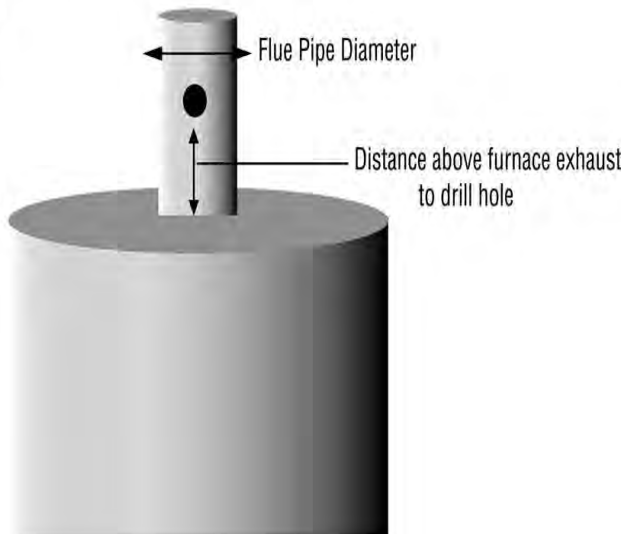

The figures on the following pages show typical test locations on commonly encountered equipment.



## TYPICAL TEST LOCATIONS

### Hot Water Heater

The flue probe must be inserted into the fire tube under the draft diverter. This prevents the sample from being diluted. It may be necessary to drill a hole in the diverter. The optional A797 flexible draft probe can be used to perform this test without drilling a hole. Please refer to the figures below.

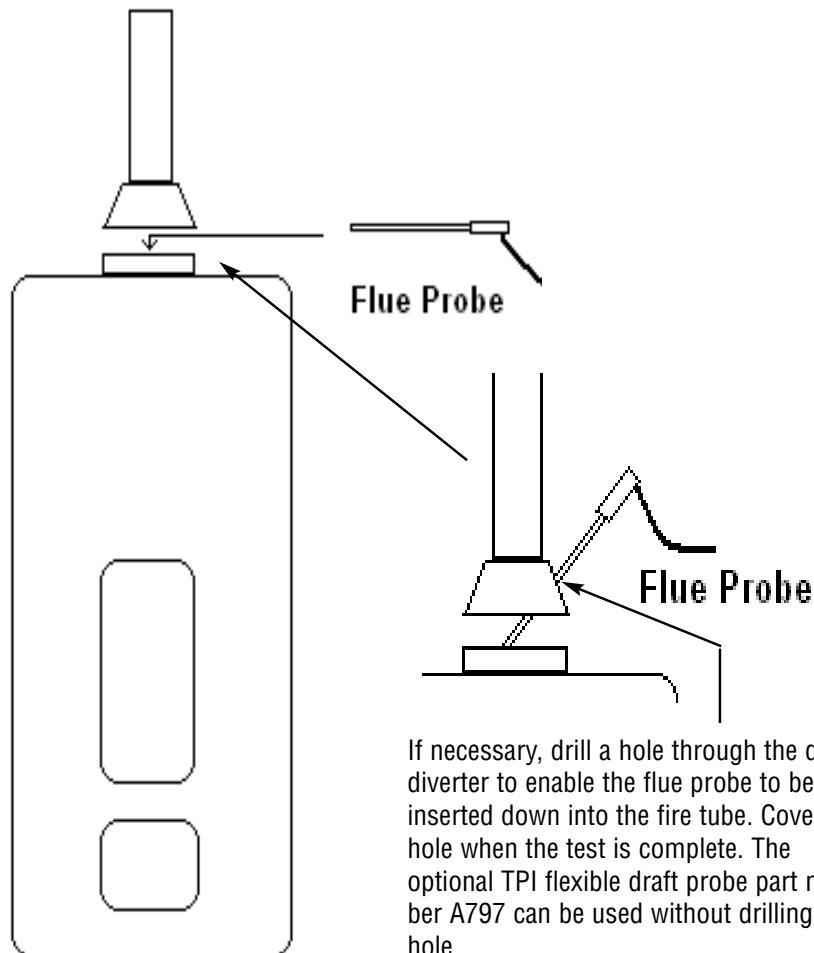

If necessary, drill a hole through the draft diverter to enable the flue probe to be inserted down into the fire tube. Cover the hole when the test is complete. The optional TPI flexible draft probe part number A797 can be used without drilling a hole.

## TYPICAL TEST LOCATIONS

### Atmospheric Gas Fired Fan Assist Boiler / Furnace

#### Typical Test Locations

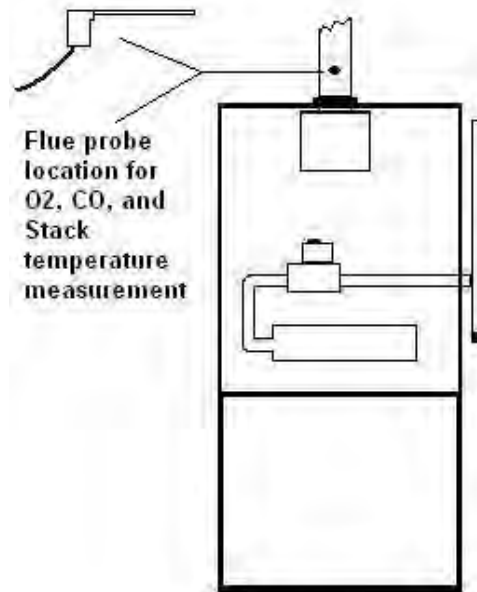

*It is important to use manufacturers recommended test locations whenever possible.*

## TYPICAL TEST LOCATIONS

### Condensing Boiler / Furnace

#### Typical Test Locations

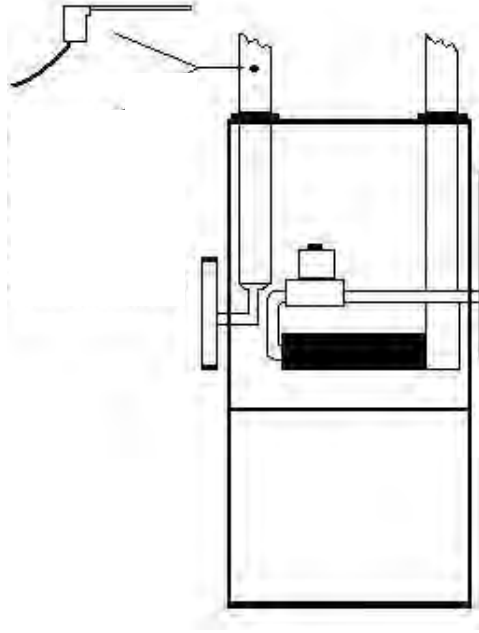

*It is important to use manufacturers recommended test locations whenever possible.*

## TYPICAL TEST LOCATIONS

### Atmospheric Forced Air Furnace

#### Typical Test Locations

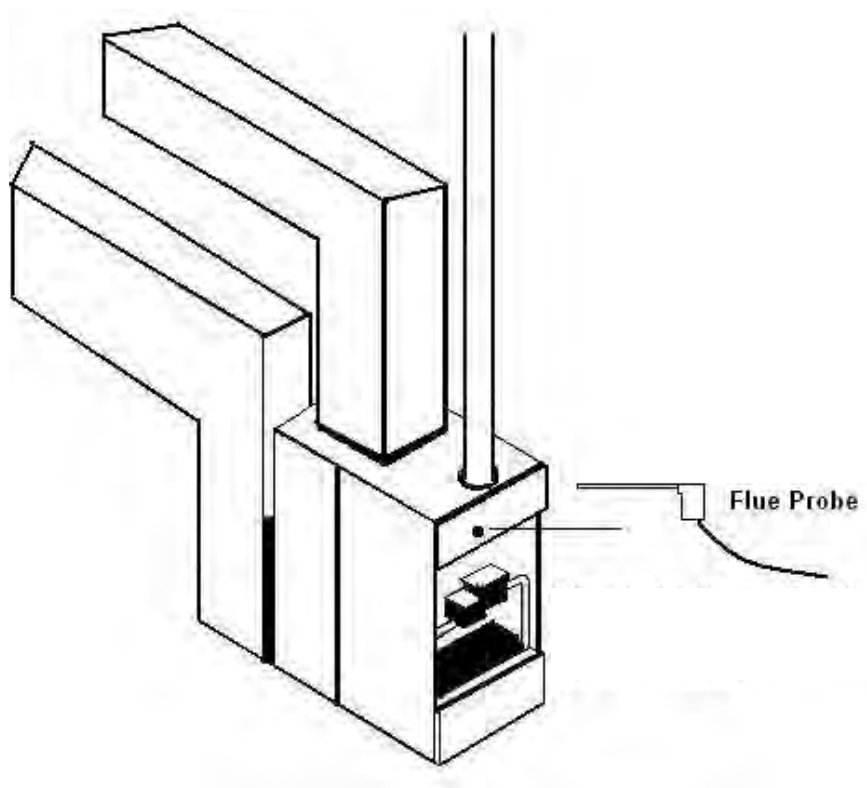

Test all exhaust ports at the top of the heat exchanger.

*It is important to use manufacturers recommended test locations whenever possible.*

4. Insert the flue probe into the sample hole of the device under test. The probe tip should be in the middle of the flue pipe or exhaust stream.

Ensure the In-Line Filter / Water Trap hangs below the analyzer in the proper vertical position when readings are being taken. Failure to comply reduces the effectiveness of the water trap and may result in damage to the instrument. Refer to the pictures below for correct and incorrect use.



**WARNING:** - Should the CO reading rise above 2,000ppm a continuous series of Alarm Beeps will be heard. The Probe should immediately be disconnected from the instrument and the instrument returned to a clean air environment. This Alarm alerts the user that there is a high concentration of CO, and this procedure will protect the sensors within the instrument. The alarm level can be changed. Please see Appendix D

Make sure to check the water trap periodically during testing to ensure it does not fill with condensate and empty it as necessary. If the filter begins to fill during a test, open the lid and empty out the condensate. After closing the lid, allow readings to stabilize again.

**IMPORTANT:** The water trap is fitted with a water block filter (p/n A794W) in the lid to prevent water from flowing down into the pump. If the water trap fills the water block filter will stop the flow to the analyzer and FLO ERR will display. The water trap should be emptied immediately if this happens. The water block filter may need to be dried out or replaced before testing can resume.

5. Allow the readings to stabilize. The CO concentration in ppm can be seen.

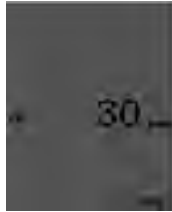

Default display shows Carbon Monoxide (CO) in parts per million (ppm)

**NOTE:** Your 707 carbon monoxide analyzer is equipped with a high quality sensor that incorporates an on-board NO/NOx filter. This filter prevents higher than normal CO readings caused by sensor cross sensitivity to NO/NOx, which is a byproduct of combustion.

When a gas appliance or hot water heater is operating properly, little or no CO will be produced. Older CO analyzers, and those equipped with sensors that do not have an on-board filter, will incorrectly read higher levels of CO because of the “NOx bump” or cross sensitivity to the NO/NOx present in the sample.

The NO/NOx cross sensitivity can increase the displayed reading by as much as 30ppm or more on analyzers with sensors that do not have the NO/NOx filter.

6. The Scroll/Enter key can be pressed to display the peak CO reading. Pressing and holding down the Down Arrow key will zero the peak reading. Pressing the Scroll/Enter key will return the 707 to normal operation.

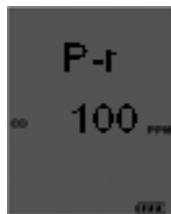

Peak display shows the highest amount of Carbon Monoxide (CO) measured in parts per million (ppm) since start up.

## Typical Test Results

*Actual test results vary depending on the equipment under test. TPI recommends you check with the manufacturer of the equipment being tested to determine specific acceptable results.*

### **Hot Water Heater**

Less than 50ppm Carbon Monoxide in the fire tube

### **Power Burners (Gas Fired)**

Less than 100ppm Carbon Monoxide in the flue

### **Power Burners (Oil Fired)**

Less than 100ppm Carbon Monoxide in the flue

### **Gas Fired Burners (Atmospheric / Fan Assist)**

Less than 100ppm Carbon Monoxide in the flue

### **Levels Near Properly Adjusted Gas Stoves**

Less than 15ppm Carbon Monoxide

## SETTING DATE AND TIME

With the analyzer running, press the Func Key to access the date/time screen. From this function Time, Date and Year can be changed.



### Function Display 4 (Date / Time)

Time  
Date / Month  
Year

***If the Date and Time do not need to be changed, press the Func Key to bypass this function and return the 712 to combustion analyzer mode (Function 1).***

1. Once the Time, Date, and Year screen is displayed, press the Scroll/Enter Key once to allow you to change the data.
2. Press the Up Arrow Key to Increase the Minutes.
3. Press the Down Arrow Key to Decrease the Minutes.
4. Press the Scroll/Enter Key to confirm the desired Minute and move onto the Hours.
5. Repeat steps 2 to 4 to change the Hour, the Day, the Month and the Year.
6. Once the date and time has been set press the Func Key to return to normal use.



## STORING DATA

During testing data can be stored for later retrieval.

**When data is saved, all data previously in the address will be overwritten. When saving pressure/draft readings, select an address different from the one used to save combustion readings.**

1. Press the Store Key. *To cancel storing information press the Store Key and use the Up/Down Arrow Keys to select “Yes” and press the Scroll/Enter Key.*
2. “Addr” and an address location from 0 to 49 will flash on the display. Use the Up/Down Arrow Keys to select the desired location to store the data and press the Scroll/Enter Key. *To cancel storing information press the Store Key and use the Up/Down Arrow Keys to select “Yes” and press the Scroll/Enter Key.*
3. The data is stored and “End” will display. Use the Up/Down Arrow Keys to select “Yes” to stop storing data and return to normal operation or select “No” to store data again. Press the Scroll/Enter Key.

You have just successfully stored a set of readings which can be reviewed on screen (see page 24) or sent to the IR printer (see page 25).

## RECALLING DATA

The recall feature allows you to display stored data or retrieve the last date of calibration.

### ***Recalling Saved Data or Calibration Date***

1. Press the Recall button once.
2. The display will show “Stor” and “Cal”. Use the Arrow buttons to select the desired function. *To cancel recalling information press the Recall Key and use the Up/Down Arrow Keys to select “Yes” and press the Scroll/Enter Key.*

**Stor** - Selecting “Stor” allows you to display the information in a memory location.

1. Press the Recall button once. The display will show “Stor” and “Cal”. Using the Arrow buttons select “Stor” by making it blink. Press the Scroll/Enter button.
2. “Addr” will be displayed and a number from 0 to 49 will flash.
3. Using the up and down arrows, select the memory location of the readings you want to display.
4. Press the Scroll/Enter key once. The 707 will display the date and time screen showing when that reading was stored.
5. Use the up and down arrows to scroll through the data that was saved.
6. Press the Scroll/Enter button and “End” will be displayed and “Yes” will flash. Press the Scroll/Enter button if you are finished recalling data or use the Arrow buttons to select No to recall data from other locations.

**CAL** - Selecting “CAL” allows you to display the last date of calibration.

1. Press the Recall button once. The display will show “Stor” and “Cal”. Using the Arrow buttons select “Cal” by making it blink. Press the Scroll/Enter button.
2. “CAL” will blink and the last calibration date will be displayed in DD/MM.YYYY format.
3. Press the Scroll/Enter button, “End” will be display and YES will blink. Press the Scroll/Enter button to return to normal operation.

## PRINTING DATA

**WARNING:** - To operate correctly there must be a clear line of sight between the Infrared Window on the instrument (see page 6) and the Infrared Window on the IR Printer (see Printer instructions). Place the printer so it is no closer than approximately 6 inches from the analyzer.

1. Press the Print Key once 'rEAL', "Stor", and "Cal" will be displayed and 'rEAL' will be flashing. *To cancel printing press the Print Key and use the Up/Down Arrow Keys to select "Yes" and press the Scroll/Enter Key.*

Selecting 'rEAL' will cause the 707 to print the test data currently on the display (real time data). Selecting 'Stor' will cause the 707 to print data stored in memory. Selecting "Cal" will cause the 707 to print the last date of calibration. Use the Up and Down Arrow Keys to select the desired print mode and press the Scroll/Enter Key.

**REAL Print Mode** - If rEAL print mode is selected, the analyzer will display 'Wait' 'out' and bars will change position on the LCD until printing is complete.

**STOR Print Mode** - If Stor mode is selected, 'Addr' will be displayed on the top line along with 'SA ' and a location number from 0 to 49 will be flashing on the screen. Select the required address location that you wish to print data from by pressing the Up and Down Arrow Keys and press the 'Scroll/Enter' Key. The analyzer will display 'Wait', 'out' and bars will change position on the LCD until printing is complete.

**CAL Print Mode** - If Cal print mode is selected, the analyzer will display 'Wait' 'out' and bars will change position on the LCD until printing is complete.

After printing is complete, 'End' will be displayed and 'YES' (or 'no') will blink. Selecting 'YES' will return the 707 to normal operation, selecting 'no' will return the 707 to the print selection screen so you can print again. Use the Up and Down Arrow Keys to make the selection and press the Scroll/Enter Key.

## PRINTING DATA (Continued)

### Printout Interpretation

```
      TPI707

Date :      12/10/10
Time :      13:40

----- Report -----
CO(ppm) :      18
Peak CO(ppm) :    104

-----
Customer :
-----
Address :
-----
Reading Accepted by :
-----
                13:42, 12/10/10
```

The diagram consists of three rectangular text boxes with arrows pointing to specific parts of the printout. The first box, labeled 'Date and time of test.', has an arrow pointing to the 'Date' and 'Time' fields. The second box, labeled 'Data from test is printed here.', has an arrow pointing to the 'CO(ppm)' and 'Peak CO(ppm)' fields. The third box, labeled 'Customer information and signed confirmation of test. (Fill in this data and have the customer sign for confirmation.)', has two arrows pointing to the 'Customer' and 'Reading Accepted by' fields.

## SPECIFICATIONS

### Instrument

Operating Temperature Range	14°F to +122°F (-10°C to +50°C)
Battery	1.5V AA size (3)
Battery Life	> 6 Hours
Display	Backlit LCD
Data Storage	50 sets of readings
Time & Date	24 Hour Real Time Clock
Dimensions	200mm x 90mm x 60mm
Weight	500g
Casing	Rubber Boot as Standard
Switch Off	Failsafe
Exhaust	Safety Spigot
Conforms to	BS7927 (and the draft BS7967)

### Flue Temperature Probe

Construction	Straight Grip with Stainless Steel Shaft
Hose Length	Approximately 5 feet
Insertion Length	200mm
Maximum Temperature	700°C for 5 minutes

### Accuracy

	Range	Resolution	Accuracy
Carbon Monoxide	0-10,000 ppm	1 ppm	+/- 5 ppm or 5% Whichever is greater

## CALIBRATION & SERVICE

It is recommended that your analyzer be calibrated every 12 months. When calibration is due the analyzer will remind you by flashing “CAL DUE Err” at start up and then return to normal operation.

The following are consumable parts for the instrument:

In-Line Filter Element (pkg of 5)	User Replaceable	A794F
Mini Pump Protection Filter Assem.	User Replaceable	A763
**Oxygen Sensor	User / Factory Replaceable	A761
**Carbon Monoxide Sensor	User / Factory Replaceable	A760
<i>**Sensor replacement requires calibration gas.</i>		

## WARRANTY

Your TPI 707 Flue Gas Analyzer is guaranteed free from defects in materials and workmanship for 3 Years from the date of purchase. This guarantee does not affect your statutory rights. For additional information please refer to the included warranty card or contact.

To obtain warranty performance or maintenance on your analyzer: - Include with the product your name, address, phone number, written description of the problem and proof of purchase date. Carefully package and return to:

## Appendix A: General Maintenance

All carbon monoxide analyzers use consumable items such as filters and probes. These items are user serviceable and can be taken care of by the operator.

The consumable items that will require operator attention are the water trap / filter assembly, flue probe, and pump protection filter.

The recommended maintenance schedule for your analyzer is as follows:

<b>Maintenance Performed</b>	<b>Frequency</b>
Water trap Check	Once per week (Once per day for analyzers that see heavy use or are used in oil fired applications)
Filter Check	
Pump Operation Check	Once per month (More often for analyzers that see heavy use or are used in oil fired applications)
Flue Probe Integrity Check	

### Water Trap Check

Visually check the water trap for:

1. Cracks in the bowl.
2. Broken ears on the bowl where the lid locks on.
3. Broken ears on the lid.
4. Worn out o-ring on the lid.
5. Loose connection to the flue probe tubing.

### Filter Check

Signs of dirty or water saturated filters are a slow pump, flow error displayed when the flue probe is connected, and measurements that take longer than normal.

TPI analyzers use three filters to protect the pump and sensors. The first filter to check is the A763 mini pump protection filter. (see picture below)



A763 Pump Protection Filter

Look in the inspection window to check the filter. When the filter material becomes dark, pull the black nose cone out of the tubing and replace the ball filter inside.

## Appendix A: General Maintenance (continued)

### Filter Check Continued

The other two filters are located in the water trap. The main filter is the A794F particle filter. This filter stops debris and dust from traveling down to the analyzer. The secondary filter is the A794W water block filter. This filter stops flow in the event the water trap fills with condensate. Refer to the picture below.

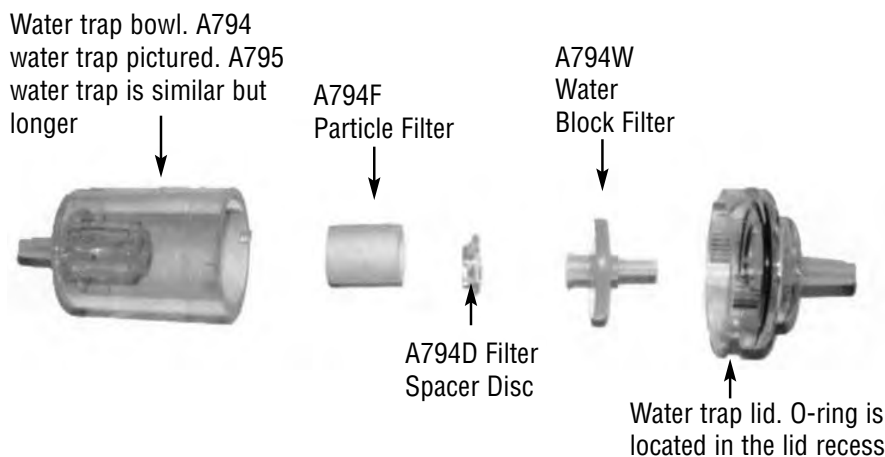

Open the water trap and look at the A794F particle filter. The filter will typically get dirty from the inside first. If the filter is dark on the inside a replacement filter should be installed.

If the A794F is clean but saturated with water a replacement should be installed to ensure proper flow. The saturated filter can be left to dry and reused later.

### Pump Operation Check

1. Turn the analyzer on as outlined on page 8. Do not connect anything to the inlet. Wait until the analyzer has completed the initial purge and sensor check and is operating normally prior to proceeding to step 2.
2. Cover the analyzer inlet with your finger. The analyzer should display "FLO ERR" and a rapid beeping should be heard.

If the analyzer does not beep and display "FLO ERR" this may be an indication the flow sensor requires calibration, the pump is faulty, or there is an internal leak. The analyzer should be returned for factory service.



## Appendix A: General Maintenance (continued)

### Flue Probe Integrity Check

NOTE: Perform this check after performing the Pump Operation Check outlined on the previous page.

1. Turn the analyzer on as outlined on page 8. Do not connect anything to the inlet. Wait until the analyzer has completed the initial purge and sensor check and is operating normally prior to proceeding to step 2.
2. Connect the A763 mini pump protection filter and flue probe assembly to the inlet of the analyzer.
3. Cover the end of the flue probe with a small piece of tube and pinch the end close. After a short period of time the analyzer should display “FLO ERR” and a rapid beeping should be heard. If this happens the flue probe is operating properly and the integrity test is complete. If the analyzer does not display “FLO ERR” this is an indication of a possible leak somewhere in the flue probe and you may proceed to the next step for further tests.
5. Pinch the hose below the handle of the flue probe. If the analyzer displays “FLO ERR” there is a leak in the handle assembly and the probe needs to be factory serviced. If the analyzer does not display “FLO ERR” proceed to the next step for further tests.
6. Pinch the hose between the analyzer and the water trap. If “FLO ERR” still does not display there may be an internal leak, pump problem, or other issue and the analyzer needs to be factory serviced. If “FLO ERR” is displayed there is a leak in the water trap assembly and the water trap assembly should be checked as outlined on page 39 & 40.

## Appendix B: A773 SULFUR FILTER INSTALLATION & MAINTENANCE

When performing combustion tests on oil fired equipment it is important to use the optional A773 sulfur filter. Failure to do so can result in incorrect and readings. This filter also protects the sensors from the affects of sulfur. The A773 does not have to be removed when working with other types of fuels.

### PROCEDURE

1. Begin with the water trap section of the flue probe oriented as shown in the picture below.

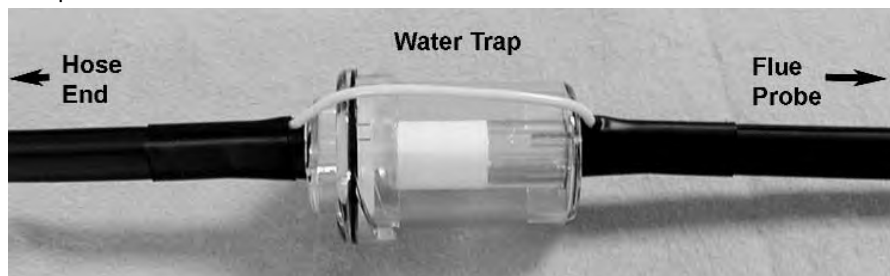

2. Remove the water trap from the flue probe hose. (See picture below)

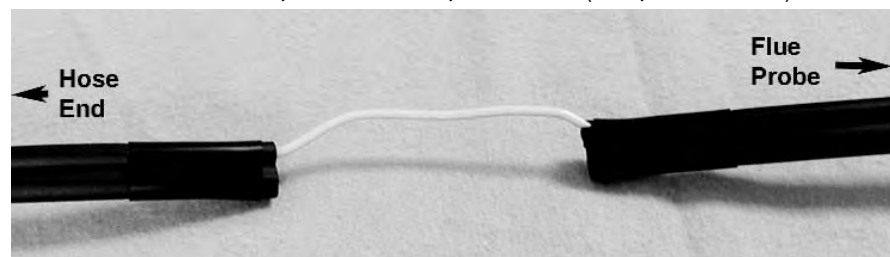

3. Insert the A773 sulfur filter flue probe tube where the water trap was removed..



## Appendix B: A773 SULFUR FILTER INSTALLATION & MAINTENANCE

4. Beginning on the "Flue Probe" side of the A773 sulfur filter, pull the yellow thermocouple cord out of the channel of the flue probe tube. Pull out approximately the length of the water trap that was removed.
5. Being careful not to cut the yellow cord, cut out a section of the flue probe tubing the length of the water trap on the "Flue Probe" side of the A773 sulfur filter. (See picture below)

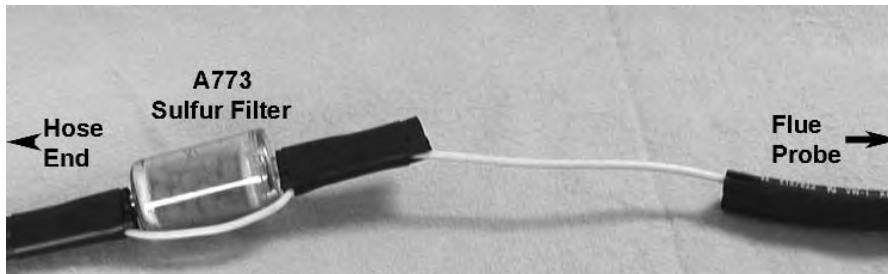

6. Install the water trap in the flue probe hose where the piece was cut out. Make sure the water trap is positioned correctly. The water trap lid should face the "Hose End" side of the hose.

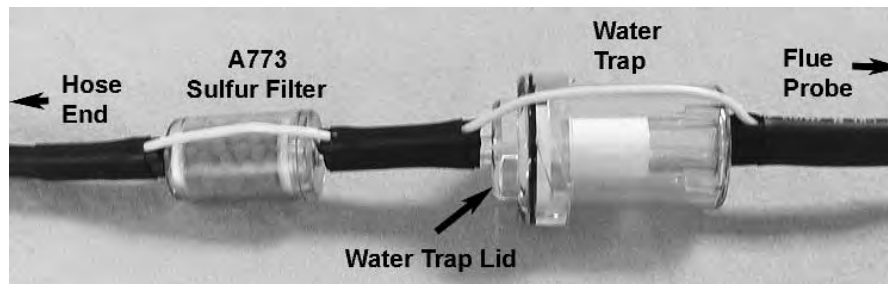

### A773 SULFUR FILTER MAINTENANCE:

The A773 should be replaced when most of the pellets become discolored, usually white or black.

If the A773 begins to trap condensate and fill with water but the pellets are not discolored to the point replacement is required, it should be removed and allowed to dry. Once it is dry it can be reused.

## Appendix C: ERROR CODES & TROUBLESHOOTING

The 707 analyzer will display certain codes to let you know of a malfunction.

Code Displayed	Code Definition	Possible Causes	Corrective Action
<b>Flo Err</b>	Pump not drawing sample at correct flow rate.	Blockage / kink in flue probe hose. Dirty or blocked filter(s). Worn pump.	Check and rectify. Replace filter(s). Return to TPI for service.
<b>Init CO Err</b>	Carbon monoxide sensor failed to initialize.	Flue probe connected to 707 prior to power up. 707 did not purge completely from last sample. Worn or defective carbon monoxide sensor.	Disconnect probe and restart. Purge for 20 minutes and restart. Return to TPI for sensor replacement or install new sensor.* Try manually initializing the sensor. See Appendix G.
<b>Lo bat</b>	Low battery.	Battery needs to be charged.	Charge battery. If the battery won't hold a charge, replace the battery.
<b>oFL</b>	Overflow indication. The carbon monoxide being measured is above the instruments capability.	CO being measured is too high or low.	Remove the CO source and allow the 707 to purge.

\*Sensor replacement requires calibration gas.

## Appendix D: CO ALARM & AUTO OFF SETTINGS

### Setting the Carbon Monoxide Alarm Point and/or Auto Power Off Mode

The CO alarm and auto power off settings can be changed as necessary by performing the following procedure.

**WARNING :** Changing parameters in field calibration mode can adversely affect the operation of your analyzer. Follow the instructions carefully.

1. Press and hold the FUNC and Down Arrow keys for approximately 5 seconds until a beep is heard. Press and hold the Scroll/Enter Key down until 'FIELD CAL' is displayed. The 707 will cycle through a 30 second countdown then display 'CAL', 'Air', 'gAS'.
2. Use the Up Arrow Key to select 'Air' by making it blink. Press the Scroll/Enter Key to accept the selection.
3. 707 Display: 'CAL', 'FLo', 'oPEn'. Action : Press the Func Key to bypass.
4. 707 Display: 'CAL', 'FLo', 'CLOs'. Action : Press the Func Key to bypass.
5. 707 Display: '0ppm', 'Co', 'rEF'. Action : Press the Func Key to bypass.
6. 707 Display: '2000', 'A-r', 'SEt'. Action : If you are not changing the CO alarm point press the Func Key. Otherwise press the Up and Down Keys to set the ppm level the alarm will sound at. Factory default is 2000ppm. Press the Scroll/Enter Key to accept the selection.
7. 707 Display: 'Auto', 'oFF', 'En'. Action : If you are not changing the auto power off mode press the Func Key. Otherwise press the Up and Down Arrow Keys to enable (En) or disable (dis) the auto off function. Factory default is enabled (En). Press the Scroll/Enter Key to accept the selection.
8. 707 Display: 'CAL', 'StoP', 'go'. Action : Press the Up Arrow Key to select 'StoP' by making it blink and press the Scroll/Enter Key to accept the selection. The 707 will return to normal operation

## Appendix E: MANUALLY INITIALIZING SENSOR

If the CO or O2 sensor fails to initialize, this procedure can be performed to try and manually initialize the sensor(s).

**WARNING** : Changing parameters in calibration mode can adversely affect the operation of your analyzer. Follow the instructions carefully.

1. Turn the analyzer on. When the countdown reaches 26, press and hold down the Up Arrow, Scroll/Enter, and Down Arrow keys together for approximately 5 to 7 seconds. The analyzer will beep and “Fact Cal” will be displayed. Release the keys. The analyzer will cycle through a 30 second countdown then display ‘CAL’, Air’, gAS’.
2. Use the Up Arrow Key to select ‘Air’ by making it blink. Press the Scroll/Enter Key to accept the selection.
3. 707 Display: ‘CAL’, ‘FLo’, ‘oPEn’. Action : Press the Func Key to bypass.
4. 707 Display: ‘CAL’, ‘FLo’, ‘CLoS’. Action : Press the Func Key to bypass.
5. 707 Display: ‘Oppm’, ‘Co’, ‘rEF’. Action : Press the Scroll/Enter Key. After the 10 second countdown is complete press the Scroll/Enter Key twice.
6. 707 Display: ‘2000’, ‘A-r’, ‘SEt’. Action : Press the Func Key to bypass.
7. 707 Display: ‘Auto’, ‘oFF’, ‘En’. Action : Press the Func Key to bypass.
8. 707 Display: ‘CAL’, ‘StoP’, ‘go’. Action : Press the Up Arrow Key to select ‘StoP’ by making it blink and press the Scroll/Enter Key to accept the selection. The 707 will return to normal operation

**If the 707 continues to fail to automatically initialize or this procedure fails to initialize the sensors, return your analyzer to Test Products International.**

## Appendix F: CARBON MONOXIDE FACTS

Carbon Monoxide (CO) is invisible, odorless, and tasteless. It is the byproduct of combustion and levels are elevated when there is incomplete combustion.

Sources of CO include:

- Unvented kerosene and gas space heaters
- Leaking chimneys & furnaces
- Gas water heaters
- Back drafting from furnaces
- Wood stoves & fireplaces
- Gas Stoves
- Automobile exhaust
- Tobacco smoke

Carbon Monoxide is picked up quickly in the body by red blood cells. At high levels of CO the body replaces oxygen with carbon monoxide.

The most common symptoms of CO poisoning are headache, dizziness, weakness, nausea, vomiting, chest pain, and confusion. High levels of CO inhalation can cause loss of consciousness and death. Unless suspected, CO poisoning can be difficult to diagnose because the symptoms mimic other illnesses.

People who are sleeping or intoxicated can die from CO poisoning before ever experiencing symptoms.

Please see the next page for a list of exposure times and symptoms.

## Appendix G: Carbon Monoxide in Ambient Air Chart

This chart contains maximum exposure levels and times for carbon monoxide. This is a general guideline only. It is recommended you check with your local government for guidelines in your area.

### **CARBON MONOXIDE** **the SILENT KILLER!**

<i>Concentration of CO in air</i>	<i>Exposure times and toxic symptoms</i>
<b>9ppm</b>	The maximum allowable concentration for short term exposure in a living area according to ASHRAE
<b>35ppm</b>	The maximum allowable concentration for continuous exposure in any 8 hour period, according to federal law. (US federal law)
<b>200ppm*</b>	Maximum concentration allowable any time according to OSHA. Slight headaches, fatigue, dizziness, nausea after 2-3 hours.
<b>400ppm*</b>	Frontal headaches within 1-2 hours, life threatening after 3 hours. Maximum allowable limit in flue gas according to EPA and AGA.
<b>800ppm*</b>	Headache, dizziness, nausea, and convulsions with 45 minutes. Unconsciousness within 2 hours. Death within 2-3 minutes.
<b>1600ppm*</b>	Headache, dizziness, and nausea within 20 minutes. Death within 1 hour.
<b>3200ppm*</b>	Headache, dizziness, and nausea within 5-10 minutes. Death within 30 minutes.
<b>6400ppm*</b>	Headache, dizziness, and nausea within 1-2 minutes. Death within 10-15 minutes.
<b>12800ppm*</b>	Death within 1-3 minutes.



## Appendix H: Battery Replacement

When the battery status indicator is empty the batteries should be changed immediately. For optimum performance replace the batteries with 3 AA size alkaline batteries. The procedure for replacing batteries is as follows:

1. Turn the analyzer over and locate the phillips head battery cover screw. See picture below.



2. Loosen the screw. Pull out on the screw to remove the battery cover.
3. Remove the old batteries and observing the polarity markings in the battery compartment, install the new batteries.
4. Re-install the battery cover by fitting the bottom part in first.
5. Tighten the battery cover screw.