



INSTRUMENTS

GX-3R Pro

Operator's Manual

Part Number: 71-0478

Revision: P16

Released: 9/16/21

WARNING

Read and understand this instruction manual before operating instrument. Improper use of the gas monitor could result in bodily harm or death.

Maintenance of the gas monitor is essential for proper operation and correct readings.

Bump test the instrument before each day's use with a known concentration of each target gas. A bump test can be done in User Mode's BUMP TEST item or by applying gas in Measuring Mode. The instrument does not need to be calibrated unless it does not pass the User Mode bump test or does not respond appropriately, as defined by the user, in Measuring Mode. For more information about bump test and calibration requirements, see IEC 60079-29-2.

Table of Contents

Chapter 1: Introduction	7
Overview	7
About the GX-3R Pro	7
Specifications	8
About this Manual	11
Chapter 2: Description	12
Overview	12
Instrument Description	12
<i>Case</i>	12
<i>LCD</i>	12
<i>Control Buttons</i>	13
<i>Alarm LEDs</i>	13
<i>Buzzer</i>	13
<i>Vibrator</i>	13
<i>Sensors</i>	13
<i>Filters</i>	14
<i>Infrared Communications Port</i>	15
<i>Charging Socket</i>	16
Included Accessories	16
<i>Alligator Clip</i>	16
<i>Rubber Boot</i>	16
<i>Wrist Strap</i>	16
<i>Single-Unit AC Charger</i>	17
<i>Calibration Cup</i>	17
Other Accessories	17
<i>12 VDC Charger</i>	17
<i>Multi-Unit AC Charger</i>	17
<i>Belt Clip</i>	18
<i>SDM-3R</i>	18
<i>RP-3R</i>	18
<i>Aspirator Adapter</i>	18
<i>IrDA Cable</i>	18
Chapter 3: Measuring Mode	19
Overview	19
Start Up	19
<i>Turning On the GX-3R Pro</i>	19
<i>Performing a Demand Zero</i>	24
<i>Turning Off the GX-3R Pro</i>	25
Measuring Mode Operation	25
<i>Monitoring an Area</i>	25
<i>Combustible Gas Detection</i>	26
<i>Oxygen-Enriched Atmospheres</i>	28
<i>H2-Compensated CO Detection</i>	28

<i>Interference Information</i>	28
<i>CO2 Detection</i>	28
<i>Aspirator Adapter Sampling</i>	29
Alarms	30
<i>Alarm Indications</i>	30
<i>Responding to Alarms</i>	32
Data Logging	36

Chapter 4: Display Mode 37

Tips for Using Display Mode	38
Peak Screen (PEAK)	39
STEL Screen (STEL)	39
TWA Screen (TWA)	40
Combustible Sensor Target Gas Conversion (HC GAS LIST)	40
User ID Screen (USER ID)	42
Station ID Screen (STATION ID)	43
Last Successful Calibration Date (CAL DATA)	43
Last Successful Bump Test Date (BUMP DATA)	44
Date, Time, and Temperature Screen (DATE)	45
Alarm Points Screen (ALARM POINTS)	46
Screen Inversion On/Off (INVERT SELECT)	47
LCD Color Scheme (LCD BACKGROUND)	47
Turning Bluetooth On/Off (BLUETOOTH)	48
Adjusting the Buzzer Volume (BUZZER VOLUME)	48
Changing Instrument Language Back to English (LANGUAGE)	49

Chapter 5: User Mode and Calibration 50

Overview	50
Entering User Mode	54
Tips for Using User Mode	55
Performing a Bump Test (BUMP TEST)	56
Performing a Calibration (GAS CAL)	62
Setting Calibration Parameters (CAL SETTING)	75
Setting Bump Test Parameters (BUMP SETTING)	78
Adjusting Man Down and Panic Settings (MAN DOWN)	82
Alarm Settings (ALARM SETTING)	85
Updating the Lunch Break Setting (LUNCH BREAK)	88
Setting the Confirmation Beep and Non-Compliance Indicator (CONFIRMATION) ..	89
Auto Backlight in Low Light (AUTO BACKLIGHT)	91
Updating the Backlight Time (BACKLIGHT TIME)	91
Turning the Key Tone On/Off (KEY TONE)	92
Display Mode Items (D MODE SETTING)	92
Reading Units for IR Sensor (IR UNIT SELECT)	93
CO2 Fresh Air Adjustment On/Off (CO2 AIR SETTING)	94
Setting the Date/Time (DATE)	94
Setting the Date Format (DATE FORMAT)	95
Changing the Instrument Language (LANGUAGE)	95
Turning the Password On/Off (USER PASSWORD)	96

Viewing the ROM/SUM (ROM/SUM).....	96
Viewing the Radio Standards (RADIO STANDARD).....	97
Returning to Measuring Mode (START MEASURE).....	98
Chapter 6: Maintenance	99
Overview	99
Troubleshooting	99
Instrument Cleaning	100
Replacing the Batteries (Alkaline Version).....	100
Recharging the Batteries (Li-ion Version)	100
Replacing the Buzzer Cover	103
Replacing the Sensor Filters	104
Replacing the Hydrophobic Dust Filter	106
Replacing a Sensor	107
Replacing the Battery Board.....	109
Chapter 7: Storage and Disposal	112
Chapter 8: General Parts List	113
Appendix A: RK Link Phone App	117
Installing the App	117
Important Setup Notes	117
Pairing a GX-3R Pro.....	117
Searching for a Paired GX-3R Pro	120
Disconnecting a Paired GX-3R Pro	121
Adjusting App Notification Settings.....	122
Defining Owner Information	124
Setting Up Email/Text Alerts	126
Changing GX-3R Pro Parameters.....	136
<i>Alarm Settings</i>	137
<i>Calibration and Bump Settings</i>	139
<i>Backlight Setting</i>	140
<i>Logger Data Settings</i>	141
Viewing Serial Number, IDs, and Bump/Cal Information	142
Viewing App Version Info	145
Appendix B: Maintenance Mode	147
Overview	147
Entering Maintenance Mode	149
Tips for Using Maintenance Mode	150
Performing a Calibration (GAS CAL)	150
Performing a Gas Test (GAS TEST).....	151
Sensor/Battery Replacement Date (SENSOR DATE)	152
Performing a Bump Test (BUMP TEST)	153
Setting Alarms to Latching or Self-Resetting (LATCHING).....	154
Turning Demand Zero On/Off (DEMAND ZERO)	154
Turning Auto Zero On/Off (AUTO ZERO)	155

Turning ID Display Function On/Off (ID DISPLAY)	155
Turning Zero Suppression On/Off (ZERO SUPPRESS)	156
Turning Zero Follower On/Off (ZERO FOLLOWER)	156
User Mode Zero Suppression (DISP ZERO SUP)	156
User Mode Zero Follower (DISP ZERO FLWR)	156
Setting the Date/Time (DATE)	157
Setting the Date Format (DATE FORMAT)	157
Setting the Instrument Language (LANGUAGE)	158
Turning the Password On/Off (MAINT PASSWORD)	158
Viewing the ROM/SUM (ROM/SUM)	159
Adjusting the LCD's Contrast (LCD CONTRAST)	160
Performing a Default (M.DEFAULT)	160
Exiting Maintenance Mode (START MEASURE)	161

Appendix C: Gas Select Mode 162

Overview	162
Entering Gas Select Mode	162
Tips for Using Gas Select Mode	163
Changing the Gas Combination (GAS COMBO)	164
Saving the Alarm Points (SAVE ALARM-P)	166
Turning the Calibration Max Span On/Off (DISP MAX SPAN)	166
Stealth and Vibrator Settings (STEALTH)	167
LEL Definition (CHANGE LEL)	168
Exiting Gas Select Mode (START MEASURE)	169

Appendix D: Interference Information 170

ESR-A13D-HCN, HCN Detection	170
ESR-A13D-NO2, NO ₂ Detection	171
ESR-A13D-PH3, PH ₃ Detection	173
ESR-A13D-SO2, SO ₂ Detection	174
ESR-A13i-H2S, H ₂ S Detection	176
ESR-A13P-CO, CO Detection	178
ESR-A1CP-COH, H ₂ -Compensated CO Detection	180
ESR-A1DP-COHS, CO Detection	182
ESR-A1DP-COHS, H ₂ S Detection	184
ESR-B134-NH3, NH ₃ Detection	186

WARNING: *Understand manual before operating. Substitution of components may impair intrinsic safety. To prevent ignition of a hazardous atmosphere, batteries must only be changed or charged in an area known to be nonhazardous.*

Chapter 1: Introduction

Overview

This chapter briefly describes the GX-3R Pro gas monitor. This chapter also describes the *GX-3R Pro Operator's Manual* (this document). Table 1 at the end of this chapter lists the specifications for the GX-3R Pro.

About the GX-3R Pro

Using an advanced detection system consisting of up to four gas sensors, the GX-3R Pro personal five-gas monitor detects the presence of combustible gas, oxygen (O₂), carbon monoxide (CO), hydrogen sulfide (H₂S), and CO₂ or a super toxic gas simultaneously. The GX-3R Pro's compact size and easy-to-use design make it ideally suited for a wide range of applications, including sewage treatment plants, utility manholes, tunnels, hazardous waste sites, power stations, petrochemical refineries, mines, paper mills, drilling rigs, and fire fighting stations. The GX-3R Pro offers a full range of features, including:

- Simultaneous monitoring of one to five gases
- Liquid crystal display (LCD) for complete and understandable information at a glance
- Ultrabright alarm LEDs
- Distinctive audible/vibrating alarms for dangerous gas conditions and audible alarms for unit malfunction
- Microprocessor control for reliability, ease of use, and advanced capabilities
- Data logging functions
- Alarm trend data
- STEL, TWA, and over range alarms
- Peak readings
- Built-in time function
- Lunch break feature
- CSA "C/US" classified as intrinsically safe (see Table 4 on page 9)

WARNING: *The Model GX-3R Pro detects oxygen deficiency, elevated levels of oxygen, combustible gases, carbon monoxide, and hydrogen sulfide, all of which can be dangerous or life threatening. When using the GX-3R Pro, you must follow the instructions and warnings in this manual to assure proper and safe operation of the unit and to minimize the risk of personal injury. Be sure to maintain and periodically calibrate the GX-3R Pro as described in this manual.*

Specifications

Table 1: Standard Sensor Specifications

	Combustible Gas, Methane (CH₄) Calibration Standard*	Oxygen (O₂)	Hydrogen Sulfide (H₂S)	Carbon Monoxide (CO)
Detection Range	0 - 100% LEL	0 - 25.0% volume	0 - 100.0 ppm	0 - 500 ppm
Service Range	n/a	25.1 - 40.0% volume	100.1 - 200.0 ppm	501 - 2,000 ppm
Reading Increment	1% LEL	0.1% volume	0.1 ppm	1 ppm
Warning Setpoint	10% LEL	19.5% volume, decreasing	5.0 ppm	25 ppm
Alarm Setpoint	25% LEL	18.0% volume, decreasing	30.0 ppm	50 ppm
Alarm H Setpoint	50% LEL	23.5% volume, increasing	100.0 ppm	1200 ppm
STEL Setpoint	n/a	n/a	5.0 ppm	200 ppm
TWA Setpoint	n/a	n/a	1.0 ppm	25 ppm

* The GX-3R Pro is also available set up for general hydrocarbons and calibrated to a combustible gas other than methane, such as isobutane. Consult RKI Instruments, Inc. for further information.

Table 2: IR Sensor Specifications

	Carbon Dioxide (CO₂)	
Detection Range	0 - 5.00% volume	0 - 10,000 ppm
Service Range	5.01 - 10.00% volume	n/a
Reading Increment	0.01% volume	20 ppm
Warning Setpoint	0.50% volume	5,000 ppm
Alarm Setpoint	3.00% volume	5,000 ppm
Alarm H Setpoint	3.00% volume	5,000 ppm
STEL Setpoint	3.00% volume	n/a
TWA Setpoint	0.50% volume	5,000 ppm

Table 3: EC Sensor Specifications

	Ammonia (NH₃)	Hydrogen Cyanide (HCN)	Nitrogen Dioxide (NO₂)	Phosphine (PH₃)	Sulfur Dioxide (SO₂)
Detection Range and Service Range	0 - 400.0 ppm (parts per million)	0 - 30.0 ppm (parts per million)	0 - 20.00 ppm (parts per million)	0 - 20.00 ppm (parts per million)	0 - 100.00 ppm (parts per million)
Reading Increment	0.5 ppm	0.1 ppm	0.05 ppm	0.01 ppm	0.05 ppm
Warning Setpoint	25 ppm	5.0 ppm	2.00 ppm	0.30 ppm	2.00 ppm
Alarm Setpoint	35 ppm	10.0 ppm	4.00 ppm	0.60 ppm	5.00 ppm
Alarm H Setpoint	300 ppm	30.0 ppm	20.0.0 ppm	0.60 ppm	100.00 ppm
STEL Setpoint	35 ppm	10.0 ppm	1.00 ppm	1.00 ppm	5.00 ppm
TWA Setpoint	25 ppm	4.7 ppm	0.50 ppm	0.30 ppm	2.00 ppm

Table 4: GX-3R Pro Specifications

Sampling Method	Diffusion
Response Time	T90 within 30 seconds
Display	Graphics LCD Display
Max. Distance for Bluetooth Connection	30 feet, unobstructed
Environmental Conditions	<ul style="list-style-type: none"> • 3000 meter maximum altitude • Operating pressure: 70 - 120 kPa (70 - 110 kPa for explosion proof) • Pollution degree 2 • IP 66/68
Operating Temperature & Humidity	<p>Continuous environment: -20°C to 50°C/Below 90% RH</p> <p>Temporary environment (up to 15 minutes): -40°C to 60°C/Below 95% RH</p>

<p>Indication Accuracy for <u>Detection</u> Range</p>	<p>Combustible Gas, Catalytic Type Sensor</p> <ul style="list-style-type: none"> • Continuous environment (-20°C to 50°C): ± 5% of reading or ± 2% LEL (whichever is greater) • Temporary environment (-40°C to -21°C and 51°C to 60°C): ± 10% LEL <p>Oxygen ± 0.5% O₂</p> <p>Hydrogen Sulfide ± 5% of reading or ± 2 ppm H₂S (whichever is greater)</p> <p>Carbon Monoxide ± 5% of reading or ± 5 ppm CO (whichever is greater)</p> <p>Carbon Dioxide (IR) ± 5% of reading or ± 2% of full scale (whichever is greater)</p> <p>HCN, NH₃, NO₂, PH₃, SO₂ (EC) ± 10% of reading or ± 5% of full scale (whichever is greater)</p>	
<p>Indication Accuracy for <u>Service</u> Range</p>	<p>Oxygen ± 3.0% O₂</p> <p>Hydrogen Sulfide, Carbon Monoxide, and Carbon Dioxide ± 20% of reading</p>	
<p>Safety/Regulatory</p>	<ul style="list-style-type: none"> • ATEX: Certificate Number: DEKRA 17ATEX0103 X II1G Ex da ia IIC T4 Ga/IM1 Ex da ia I Ma (with NCR-6309) II1G Ex ia IIC T4 Ga/IM1 Ex ia I Ma (without NCR-6309) • IECEX: Certificate Number: IECEX DEK 17.0050X Ex da ia IIC T4 Ga/Ex da ia I Ma (with NCR-6309) Ex ia IIC T4 Ga/Ex ia I Ma (without NCR-6309) • CSA classified, “C/US”, as Intrinsically Safe. Class I Division 1 Groups A, B, C, D T4. Class I, Zones 0, A/Ex da ia IIC T4 Ga (with NCR-6309) Class I, Zones 0, A/Ex ia IIC T4 Ga (without NCR-6309) Alkaline version not verified with CAN/CSA 60079-29-1 & ANSI/ISA 60079-29-1 <div style="text-align: center;">  C US 186718 </div>	
<p>Power Supply</p>	<ul style="list-style-type: none"> • Lithium ion battery pack (3.7 VDC, 200 mA) OR <ul style="list-style-type: none"> • Alkaline battery pack with 2 AAA batteries (3.0 VDC, 250 mA) 	
<p>Continuous Operating Hours @ 25 °C in Measuring Mode (Non-Alarm Operation)</p>	<p>Lithium Ion Battery Pack</p>	<ul style="list-style-type: none"> • Standard 4 gas + super-toxic EC: 25 hours • Super-toxic EC only: 50 hours • Standard 4 gas + IR: 16 hours • IR only: 24 hours
	<p>Alkaline Battery Pack</p>	<ul style="list-style-type: none"> • Standard 4 gas + super-toxic EC: 16 hours • Super-toxic EC only: 32 hours • Standard 4 gas + IR: 7 hours • IR only: 12 hours
<p>Battery Charger Ratings</p>	<p>Input: 100 - 240 VAC, 47 - 63 Hz, 2.4 A Output: 5.99 VDC, 2A max</p>	
<p>Case</p>	<p>High-impact Plastic, RF Shielded, Dust and Weather Proof (IP66/68)</p>	

Included Accessories	<ul style="list-style-type: none"> • Alligator clip • Rubber boot • Wrist strap • Calibration cup • Single-unit charger (included with Li-ion versions only)
Other Accessories	<ul style="list-style-type: none"> • 12 VDC charger • Multi-unit charger • Belt clip • SDM-3R • RP-3R • Aspirator adapter • IrDA/USB Cable for connecting to a computer when using the Data Logger Management Program (not needed if computer has an infrared port)
Dimensions and Weight	<p><u>Lithium Ion Battery Pack Version</u> Approximately 65(H) x 73(W) x 26(D) mm (2.6”H x 2.9”W x 1.0”D) Approximately 120 g (4.2 oz.)</p> <p><u>Alkaline Battery Pack Version</u> Approximately 65(H) x 73(W) x 34(D) mm (2.6”H x 2.9”W x 1.3”D) Approximately 140 g (4.9 oz.)</p>

About this Manual

The *GX-3R Pro Operator’s Manual* uses the following conventions for notes, cautions, and warnings.

NOTE: Describes additional or critical information.

CAUTION: Describes potential damage to equipment.

WARNING: Describes potential danger that can result in injury or death.

Chapter 2: Description

Overview

This chapter describes the GX-3R Pro instrument and its accessories.

Instrument Description

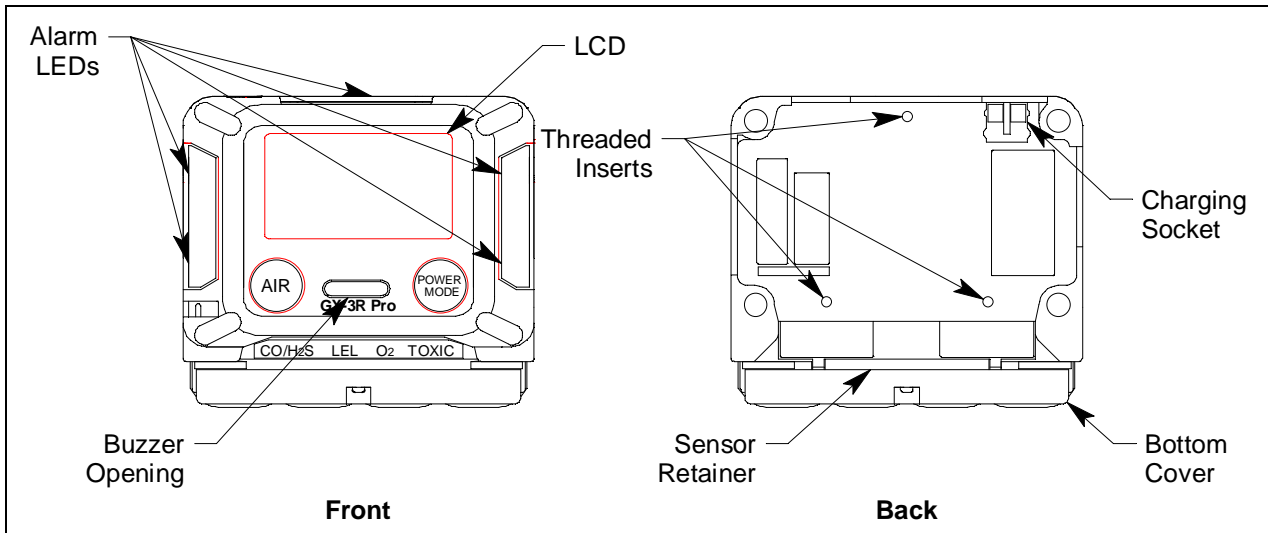

Figure 1: Component Location

Case

The GX-3R Pro's sturdy, high-impact plastic case is radio frequency (RF) resistant and is suitable for use in many environmental conditions, indoors and out. The case is dust proof and water resistant. A clear plastic window on the front of the case allows for LCD viewing. The black bottom cover, located on the bottom of the case, allows access to the filters and sensors. A sensor retainer and filter gasket help orient and retain the sensor and filters.

Three threaded inserts on the back of the case allow for installation of an alligator clip or belt clip.

LCD

A digital LCD (liquid crystal display) is visible through a clear plastic window in the top case. The LCD simultaneously shows the gas reading for all installed sensors. The LCD also shows information for each of the GX-3R Pro's operating modes.

Control Buttons

Two control buttons, AIR and POWER MODE are located below the LCD.

Table 5: GX-3R Pro Control Button Functions

Button	Function(s)
AIR	<ul style="list-style-type: none">• turns on LCD backlight• resets alarm condition if LATCHING is set to ON in Maintenance Mode• enters User Mode, Maintenance Mode, and Gas Select Mode when used with POWER MODE button• activates the demand zero function (adjusts the GX-3R Pro's fresh air reading)• changes the value of a parameter available for adjustment• scrolls through parameter options
POWER MODE	<ul style="list-style-type: none">• turns the GX-3R Pro on and off• turns on LCD backlight• enters and scrolls through Display Mode• enters instructions into the GX-3R Pro's microprocessor• resets alarm condition if LATCHING is set to ON in Maintenance Mode• enters User Mode, Maintenance Mode, and Gas Select Mode when used with AIR button

Alarm LEDs

Five sets of red alarm LEDs (light emitting diodes) around the edge of the case alert you to gas, low battery, and failure alarms.

Buzzer

One solid-state electronic buzzer is located inside the case. Sound exits the case through a hole in the middle front of the case. The buzzer sounds for gas alarms, malfunctions, low battery voltage, and as an indicator during use of the GX-3R Pro's many display and adjustment options.

Vibrator

A vibrating motor inside the GX-3R Pro case vibrates for gas alarms, unit malfunctions, and as an indicator during normal use of the various modes of the GX-3R Pro.

NOTE: If **STEALTH** is set to **ON**, the vibrator only functions when **VIBRATION** in the **STEALTH** Gas Select Mode item is set to **ON**. See "Stealth and Vibrator Settings (STEALTH)" on page 167.

Sensors

The GX-3R Pro uses four sensors to monitor up to 5 gases simultaneously. The sensor retainer and bottom cover hold the sensors in place. The sensors use different detection principles, as described below.

Combustible Gas Sensor

The combustible gas sensor detects combustible gas in the % LEL range using 2 catalytic elements: a standard element and a poison-resistant element that is resistant to sensor poisons like silicone. The element's resistance changes based on the reaction of gas with oxygen. The change in resistance affects the current flowing through the element. The GX-3R Pro's circuitry amplifies the current, converts the current to a gas concentration, and displays the

concentration on the LCD.

The standard calibration for the combustible gas sensor is to methane but the sensor will still detect and respond to a variety of combustible gases.

O₂/CO/H₂S/Super Toxic Sensors

The O₂, CO, H₂S, and super toxic sensors are electrochemical cells that consist of two precious metal electrodes in a dilute acid electrolyte. A gas permeable membrane covers the sensor face and allows gas to diffuse into the electrolyte. The gas reacts in the sensor and produces a current proportional to the concentration of the target gas. The GX-3R Pro's circuitry amplifies the current, converts the current to a gas concentration, and displays the concentration on the LCD.

There are 4 different types of CO and H₂S sensors available:

- CO only (ESR-A13P-CO): A single electrochemical cell that detects CO.
- H₂ compensated CO (ESR-A1CP-CO-H): A single electrochemical cell that detects CO. This sensor does not respond to or responds minimally to hydrogen (displays H₂ RICH once H₂ concentration reaches 2000 ppm).
- H₂S only (ESR-A13i-H₂S): A single electrochemical cell that detects H₂S.
- CO/H₂S (ESR-A1DR-COHS): A combination electrochemical cell that detects both CO and H₂S.

IR Sensors

The infrared sensors detect CO₂ in the ppm and %volume ranges. Gas enters the sensor through an opening on its face. Infrared light shines through the gas and into an infrared detector. The intensity of the infrared light changes with the gas concentration and this change is converted to an electrical signal. The GX-3R Pro's circuitry converts the signal into a gas concentration and displays the gas concentration on the LCD.

Dummy Sensors

A dummy sensor is installed in any units that have less than 4 sensors. Dummy sensors are factory installed. The flat side of the dummy sensor faces away from the GX-3R Pro and the hollow side faces toward the GX-3R Pro.

Filters

Combustible Gas Sensor H₂S Removal Filter Disk (Dark Red)

An H₂S removal filter disk is placed into a recess in the filter gasket over the combustible gas sensor. The filter disk prolongs the life of the combustible gas sensor by preventing H₂S in the ambient air from reaching the sensor. The H₂S filter disk is dark red in color and although it may darken over time, its color is not indicative of remaining filter life.

The H₂S filter disk needs replacing once it's been exposed to 33 ppm hours of H₂S. This means the filter needs replacing after 80 minutes of exposure to 25 ppm H₂S which equates to 40 2-minute calibrations with a cylinder containing 25 ppm H₂S. If H₂S exists in the monitoring environment, the H₂S filter disk will have to be replaced more frequently.

CO/H₂S Sensor Dual Filter (Black and White)

A dual filter is placed into a recess in the filter gasket over the dual CO/H₂S sensor. The black half is a charcoal filter for the CO sensor. The white half is a humidity filter for the H₂S sensor.

Replace the filter if you notice:

- Unexplained CO readings.
- For users with a 1 ppm H₂S alarm setpoint: A drift on the H₂S zero reading,

unexplained H₂S readings, the filter appears dirty, or every 6 months (whichever is sooner).

CO Sensor Charcoal Filter (Black)

A black charcoal filter is placed into a recess in the filter gasket over the CO sensor. The charcoal filter disk scrubs H₂S and certain hydrocarbons out of the sample to avoid false CO readings. If false or elevated CO readings are noticed, especially in the presence of H₂S, change the charcoal filter.

H₂S and PH₃ Sensors' Humidity Filter (White)

A white humidity filter is placed into a recess in the filter gasket over the H₂S or PH₃ sensor (if an H₂S or PH₃ sensor is installed). The filter absorbs humidity in the sampling environment to prevent unstable readings around 0 ppm. "H₂S" and "PH₃" are printed on the side of the filter.

- H₂S: For users with a 1 ppm H₂S alarm setpoint, the filter should be replaced every 6 months, if you notice a drift on the zero reading, or if the filter appears dirty (whichever is sooner). For users with a 2 ppm or higher H₂S alarm setpoint, the filter does not necessarily ever need to be replaced.
- PH₃: The filter should be replaced every 6 months.

NO₂ and SO₂ Sensors' H₂S Removal Filter Disk (Tan)

An H₂S removal filter disk is placed into a recess in the filter gasket over the NO₂ or SO₂ sensor (if an NO₂ or SO₂ sensor is installed). The filter disk prolongs the life of the sensors by preventing H₂S in the ambient air from reaching the sensor. The filter should be replaced every 6 months.

HCN Sensor's H₂S Removal Filter Disk (Dark Gray)

An H₂S removal filter disk is placed into a recess in the filter gasket over the HCN sensor (if an HCN sensor is installed). The filter disk prolongs the life of the sensors by preventing H₂S in the ambient air from reaching the sensor. The filter should be replaced every 6 months.

NH₃ Sensor's Humidity Filter (White)

A white humidity filter is placed into a recess in the filter gasket over the NH₃ sensor (if an NH₃ sensor is installed). The filter absorbs humidity in the sampling environment to prevent unstable readings around 0 ppm. The filter should be replaced every 6 months. "NH₃" is printed on the side of the filter.

Hydrophobic Dust Filter

The oval-shaped hydrophobic dust filter is attached to the top of the filter gasket, covering the sensor ports and the filters. The filter gasket and hydrophobic dust filter get replaced as a set.

NOTE: Some GX-3R Pros have a hydrophobic dust filter that is not attached to the filter gasket. When replacing the hydrophobic dust filter on one of these GX-3R Pros, remove the filter and the gasket and replace it with a filter gasket/hydrophobic dust filter assembly.

Infrared Communications Port

An infrared (IR) communications port is located on the top of the case, near the top LEDs. Logged data transmits through the port in standard IrDA protocol. A computer's infrared port or an IrDA/USB cable connected to a USB port can be used to download data to the GX-3R Data Logger Management Program. See the GX-3R Data Logger Management Program operator's manual for data logging and downloading instructions.

Battery Pack

The GX-3R Pro is either powered by a rechargeable lithium-ion (Li-ion) battery pack or an alkaline battery pack with 2 AAA batteries (Duracell MN2400 or PC2400). Instruments with a Li-ion battery pack have a charging socket on the back of the instrument. Instruments with an alkaline battery pack have a cover that allows for battery replacement.

The battery icon in the upper right of the LCD shows remaining battery life. A low battery warning activates when the GX-3R Pro detects a low battery voltage. The GX-3R Pro sounds a dead battery alarm when battery voltage is too low for Measuring Mode.

NOTE: Use of batteries or battery chargers not specified by RKI Instruments, Inc. will compromise the CSA classification and may void the warranty. See pg.100 and pg.102 for more information.

WARNING: *To prevent ignition of a hazardous atmosphere, batteries must only be changed or charged in an area known to be nonhazardous.*

AVERTISSEMENT: *Pour éviter l'inflammation d'une atmosphère dangereuse, les batteries doivent uniquement être modifiés ou facturés dans une zone connue comme non dangereuse.*

Included Accessories

Alligator Clip

An alligator clip is installed on the back of the GX-3R Pro. The alligator clip can be used to attach the GX-3R Pro to clothing or a belt. Teeth in the alligator clip's jaws prevent the unit from slipping off. The alligator clip can be rotated to change the instrument's orientation.

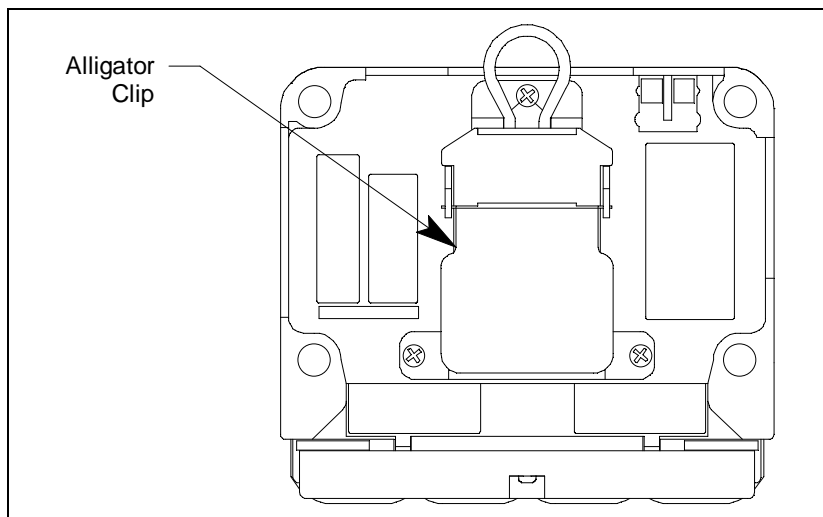

Figure 2: Alligator Clip

Rubber Boot

A black rubber boot is installed on the GX-3R Pro.

Wrist Strap

A wrist strap is included with the GX-3R Pro and can be attached to the wrist strap installation feature on the left side of the GX-3R Pro's case.

Single-Unit AC Charger

The charging cable is a 4 foot cable with an AC adapter on one end and a charging plug that connects to the GX-3R Pro on the other end.

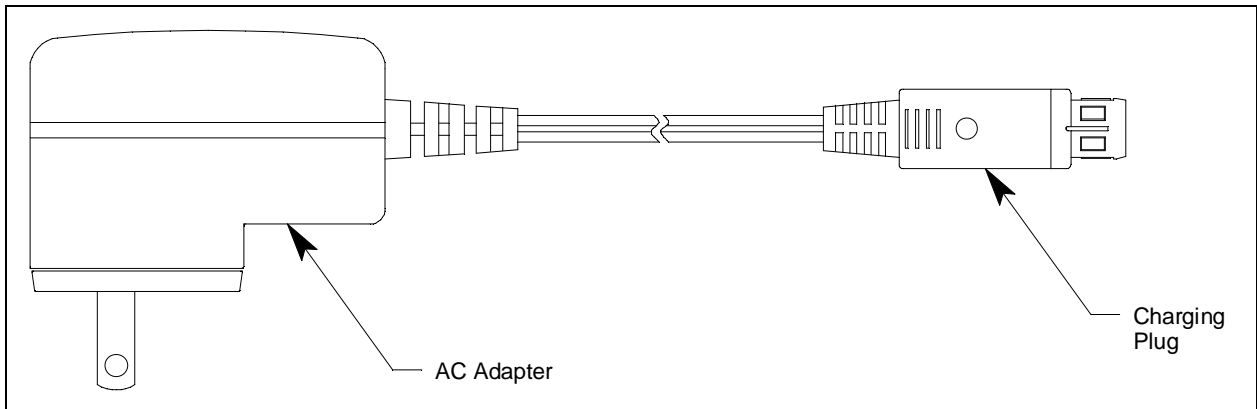

Figure 3: Charging Cable

Calibration Cup

Use the calibration cup to apply gas during a bump test, calibration, or gas test. The calibration cup has an installation orientation to observe. “Front” and “rear” imprinting on the bottom of the cup correspond to the front and rear of the GX-3R Pro when the calibration cup is installed. In addition, a “front” label on the front of the calibration cup should be visible when viewing the LCD with the calibration cup installed.

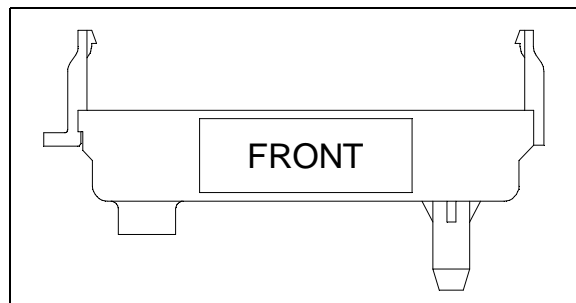

Figure 4: Calibration Cup

Other Accessories

12 VDC Charger

The 12 VDC charger is a 4 foot cable with a vehicle plug on one end and a plug that connects to the GX-3R’s power jack on the other end.

Multi-Unit Charger

The multi-unit charger is a 4 foot wall plug style adapter that plugs into a bar. The bar has five 2-foot cables coming out one side. The end of each of the five cables has a plug that connects to the GX-3R Pro’s power jack. The AC adapter is rated 100 - 240 VAC input, 5.99 VDC output.

Belt Clip

A belt clip makes it easy to hook the GX-3R Pro to a utility belt.

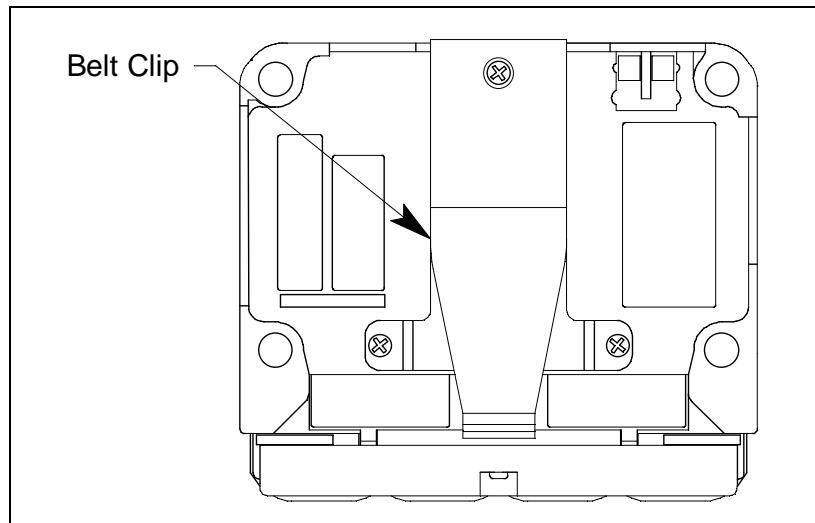

Figure 5: Belt Clip

SDM-3R

The SDM-3R is a calibration station for the GX-3R and GX-3R Pro. The station's buttons can be used for operations (Standalone Mode) or a computer can be used to control the docking station (PC Controlled Mode). See the appropriate SDM-3R manual for more information.

RP-3R

The RP-3R is a pump that draws sample to the GX-3R Pro. See the RP-3R manual for more information.

Aspirator Adapter

The aspirator adapter is a squeeze-bulb assembly that draws sample to the GX-3R Pro.

IrDA Cable

Unless your computer has a built-in IrDA port, an IrDA cable is needed to establish communication between the GX-3R Pro and the Datalogging Program.

Chapter 3: Operation

Overview

This chapter explains how to perform confined space entry monitoring or general area monitoring in the GX-3R Pro's Measuring Mode.

Start Up

This section explains how to start up the GX-3R Pro, get it ready for operation, and turn it off.

NOTE: The screens illustrated in this section are for a 4-gas + 0 - 10.00% volume CO₂ unit. The screens displayed by your GX-3R Pro may be slightly different.

Turning On the GX-3R Pro

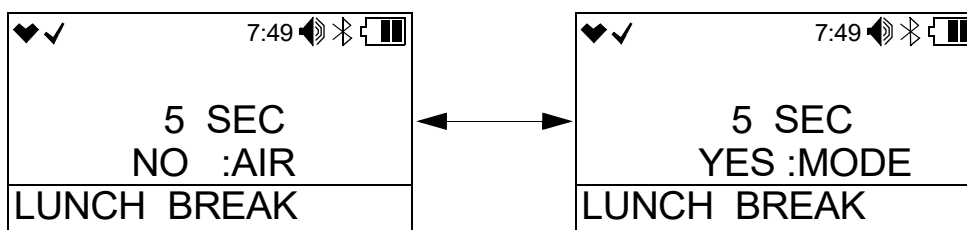

To illustrate certain functions, the following description of the GX-3R Pro start up sequence assumes that the following menu items are turned on: **LUNCH BREAK**, **CAL REMINDER**, and **BUMP REMINDER** in User Mode, and **ID DISPLAY** and **AUTO ZERO** in Maintenance Mode. If any of these items are turned off, then the corresponding screens will not appear.

1. Press and briefly hold down POWER MODE. Confirm that the LCD turns on, the LEDs flash, the buzzer sounds, and the motor vibrates before continuing with operation. Release the POWER MODE button when you hear a beep.
2. If **LUNCH BREAK** is set to **ON** (factory setting is **OFF**, see pg.88), the Lunch Break Screen appears. The unit counts down from 5 seconds.

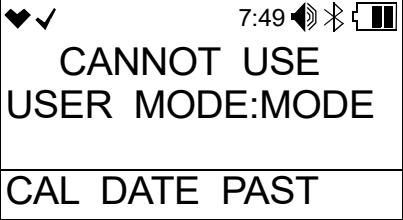

- a. Continue Accumulating: To continue accumulating peak and time-weighted average (TWA) readings from the last time the GX-3R Pro was used, press and release POWER MODE or allow the countdown to reach 0. The short-term exposure limit (STEL) reading is reset each time the GX-3R Pro is turned on.
- b. Reset Accumulation: To reset the accumulation of peak and time-weighted average (TWA) readings, press and release AIR before the countdown reaches 0.

3. If **CAL REMINDER** is set to **ON** (factory setting) and a calibration is due, the screen that appears next depends on how **CAL EXPIRED** is set in User Mode (see pg.76). The three possible screens are described below. If a calibration is not due, the instrument displays the number of days left until a calibration is due.

	CAL EXPIRED set to CONFIRM TO USE (factory setting)	CAL EXPIRED set to CANNOT USE	CAL EXPIRED set to NO EFFECT
LCD	 <p>CONFIRM TO USE USER MODE:MODE NO :AIR CAL DATE PAST</p>	 <p>CANNOT USE USER MODE:MODE CAL DATE PAST</p>	 <p>NO EFFECT USER MODE:MODE CAL DATE PAST</p>
Sound	Buzzer sounds double pulsing tone	Buzzer sounds double pulsing tone	None
Action	<ul style="list-style-type: none"> • <u>Option A, Perform calibration</u>: Press and release POWER MODE to perform a calibration. The instrument takes you straight to the AUTO CAL CYLINDER A screen in User Mode's GAS CAL\AUTO CAL item. See pg.62 for calibration instructions. If the calibration is successful, the screen above will not appear again until the unit is due for calibration. If the calibration is not successful, the screen above will again appear in the startup sequence. • <u>Option B, Bypass message</u>: To continue without performing a calibration, press and release AIR. 	<p>The GX-3R Pro cannot be used until a successful calibration is performed. Press and release POWER MODE to perform a calibration. The instrument takes you straight to the AUTO CAL CYLINDER A screen in User Mode's GAS CAL\AUTO CAL item. If you don't press POWER MODE, the instrument automatically goes to the AUTO CAL CYLINDER A screen after 6 seconds. See pg.62 for calibration instructions.</p> <p>If the calibration is successful, the screen above will not appear again until the unit is due for calibration. If the calibration is not successful, the screen above will again appear in the startup sequence.</p>	<ul style="list-style-type: none"> • <u>Option A, Perform calibration</u>: To perform a calibration, press and release POWER MODE. The instrument takes you straight to the AUTO CAL CYLINDER A screen in User Mode's GAS CAL\AUTO CAL item. • <u>Option B, Bypass message</u>: To continue without performing a calibration, wait a few seconds for the instrument to continue with its startup sequence.

4. If **BUMP REMINDER** is set to **ON** (factory setting is **OFF**) and a bump test is due, the screen that appears next depends on how **BUMP EXPIRED** is set in User Mode (see pg.81). The three possible screens are described below. If a bump test is not due, the instrument displays the number of days left until a bump test is due.

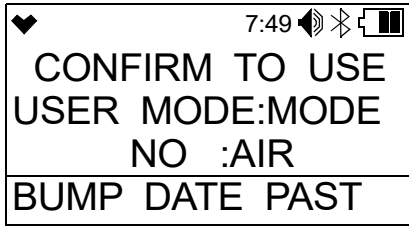
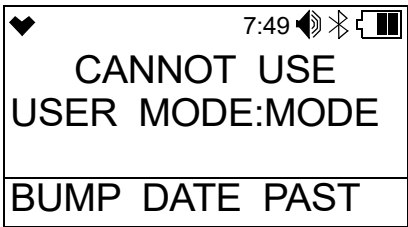
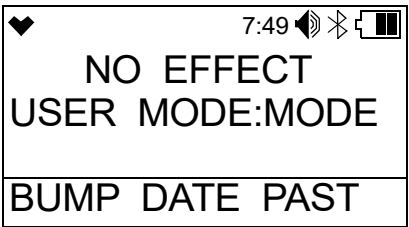
	BUMP EXPIRED set to CONFIRM TO USE (factory setting)	BUMP EXPIRED set to CANNOT USE	BUMP EXPIRED set to NO EFFECT
LCD			
Sound	Buzzer sounds double pulsing tone	Buzzer sounds double pulsing tone	None
Action	<ul style="list-style-type: none"> Option A, Perform bump test: Press and release POWER MODE to perform a bump test. The instrument takes you straight to the BUMP TEST CYLINDER A screen in the BUMP TEST User Mode item. See pg.56 for bump test instructions. If the bump test is successful, the screen above will not appear again until the unit is due for bump testing. If the bump test is not successful, the screen above will again appear in the startup sequence. Option B, Bypass message: To continue without performing a bump test, press and release AIR. 	<p>The GX-3R Pro cannot be used until a successful bump test is performed. Press and release POWER MODE to perform a bump test. The instrument takes you straight to the BUMP TEST CYLINDER A screen in the BUMP TEST User Mode item. If you don't press POWER MODE, the instrument automatically goes to the BUMP TEST CYLINDER A screen after 6 seconds. See pg.56 for bump test instructions.</p> <p>If the bump test is successful, the screen above will not appear again until the unit is due for bump testing. If the bump test is not successful, the screen above will again appear in the startup sequence.</p>	<ul style="list-style-type: none"> Option A, Perform bump test: To perform a bump test, press and release POWER MODE. The instrument takes you straight to the BUMP TEST CYLINDER A screen in the BUMP TEST User Mode item. Option B, Bypass message: To continue without performing a bump test, wait a few seconds for the instrument to continue with its startup sequence.

5. The Date/Time Screen appears for a few seconds.

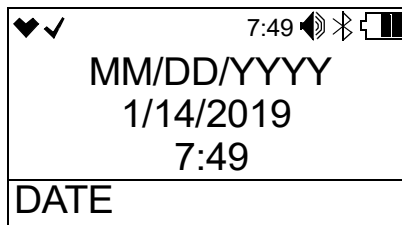

6. The Battery Voltage Screen appears for a few seconds. The battery voltage is on the top line. The alarm latching/self-resetting setting is on the second line (see pg.154 for a description of how to change this setting). The battery pack type is on the bottom line.

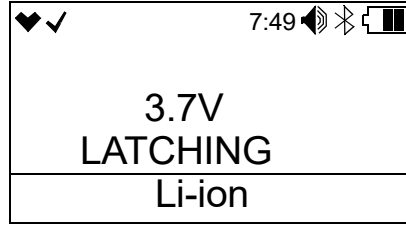

7. The following screens display for 3 seconds each: the Gas Name Screen, the Full Scale Screen, the Warning Setpoint Screen, the Alarm Setpoint Screen, the Alarm H Setpoint Screen, the STEL Alarm Screen, and the TWA Alarm Screen.

NOTE: If the combustible gas is set to something other than CH4 or H2 in Gas Select Mode, the combustible channel is displayed as “HC” and the gas formula for the combustible gas sensor’s target gas appears during startup.

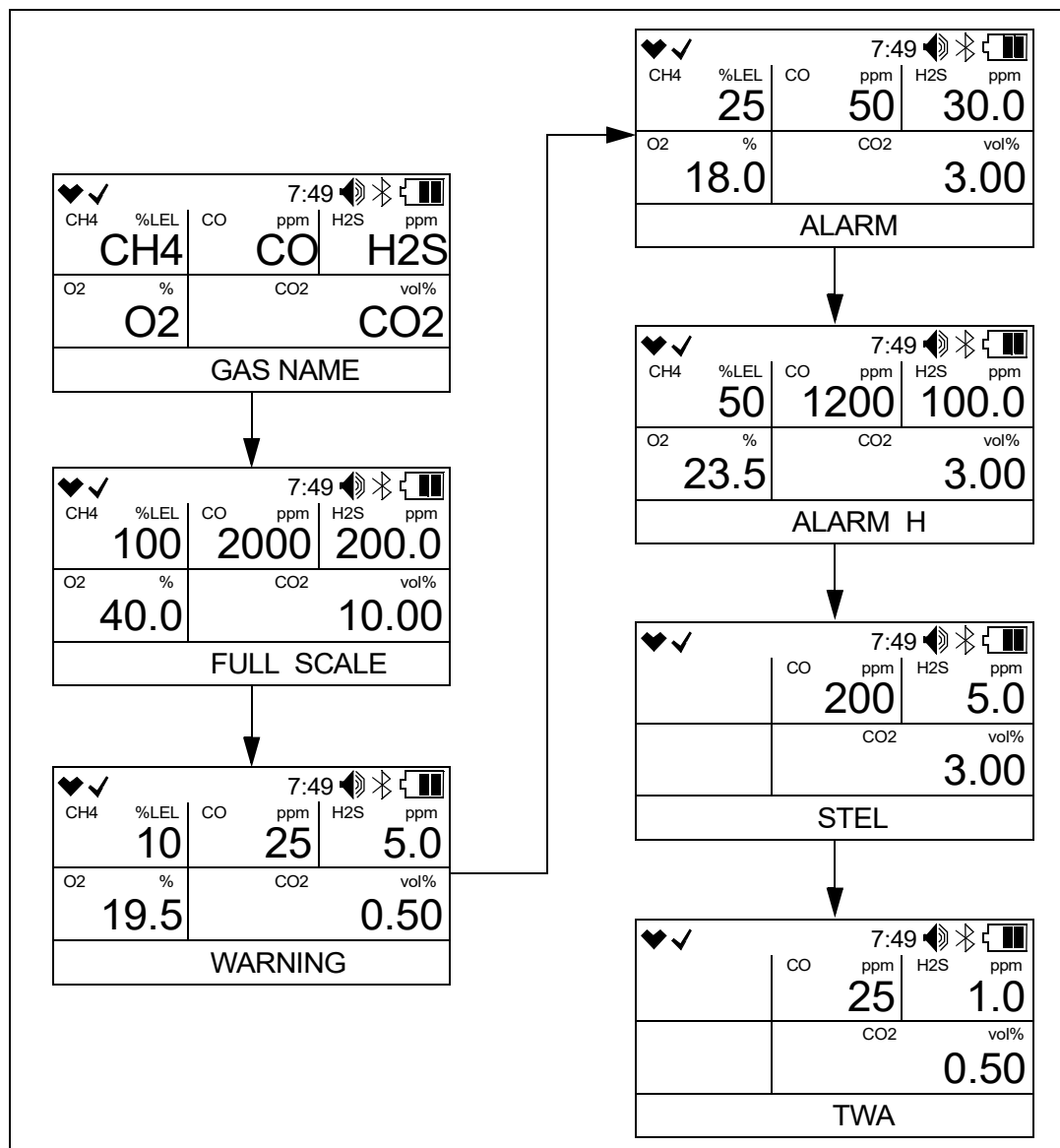

8. If **ID DISPLAY** is set to **ON** (factory setting is **OFF**, see pg.155), the User ID Screen appears for a few seconds, followed by the Station ID Screen.

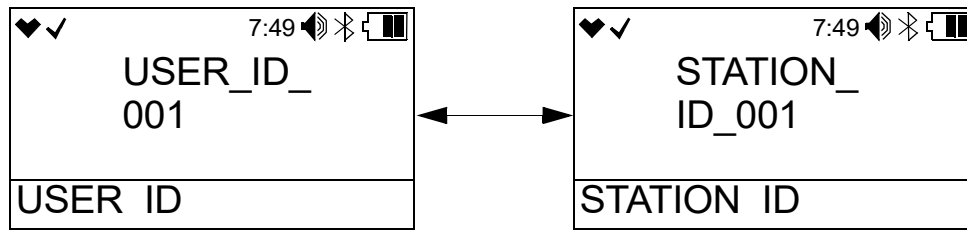

9. If the GX-3R Pro experiences a sensor failure during start up, the display shows which sensor failed and the buzzer sounds a double pulsing tone once per second. In the example below, the combustible gas sensor failed.

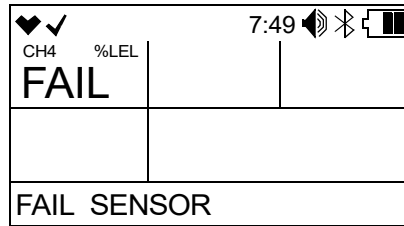

Press and release **POWER MODE** to acknowledge the failure and continue. “- - -” replaces the failed sensor’s gas reading. Replace the failed sensor as soon as possible.

10. If **AUTOZERO** is set to **ON** (factory setting is **OFF**, see pg.155), the instrument prompts you to do an auto zero.

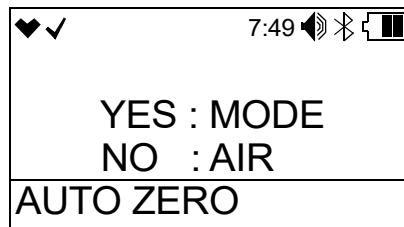

WARNING: *Make sure that the instrument is in a known fresh air environment (an environment free of combustible or toxic gases and of normal oxygen content, 20.9%) before performing an auto zero operation. If you perform an auto zero operation in an area with gases present, the adjustment will not be accurate.*

- An auto zero operation sets the combustible gas, H₂S, CO, and super toxic channels to 0 and the OXY channel to 20.9%.
- If the instrument has a CO₂ sensor installed and if **CO2AIR SETTING** is set to **ON** in User Mode, the CO₂ channel gets set to 400 ppm (0.04% volume) during an auto zero. If **CO2AIR SETTING** is set to **OFF** in User Mode, the CO₂ channel is not adjusted during the auto zero.
- You must press and release **POWER MODE** to perform an auto zero function. If you do not press any key, after 15 seconds, the instrument enters Measuring Mode without performing an auto zero.

- 11 . The combustible gas sensor actually contains 2 separate sensors: a standard catalytic sensor and a backup, poison-resistant sensor that is resistant to sensor poisons like silicone. A LIMITED HC GAS LIST alarm indicates that the standard sensor has a reduced output, possibly due to one or more sensor poisons in the environment, and that the poison-resistant sensor is being used to provide gas readings. The poison-resistant sensor has a limited list of detectable gases. The table shown on pg.40 shows which gases can and cannot be detected after receiving a LIMITED HC GAS LIST alarm.

If your application requires detection of a gas still detectable after a LIMITED HC GAS LIST alarm (like methane or isobutane), there is no need to replace the combustible gas sensor.

However, if your application requires detection of a gas not detectable after a LIMITED HC GAS LIST alarm (like methanol or ethanol), you must replace the combustible gas sensor as soon as possible.

The following screen displays, the LEDs flash, and the instrument beeps.

Press and release POWER MODE to confirm the limited gas list and continue to Measuring Mode.

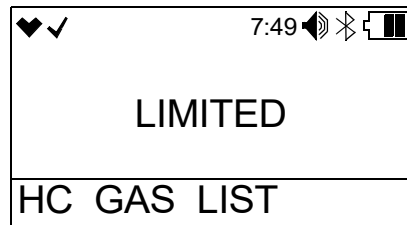

- 12 . At the end of the 45 second warmup, the GX-3R Pro begins monitoring for gas in Measuring Mode. The Measuring Mode Screen displays the current gas reading for each target gas.

♥✓		7:49		🔊 🔌 🔋	
CH4	%LEL	CO	ppm	H2S	ppm
	0		0		0.0
O2	%	CO2	vol%		
	20.9		0.00		

Performing a Demand Zero

Perform a demand zero before using the GX-3R Pro. A demand zero operation sets the combustible gas, H₂S, CO, and super toxic channels to zero and the OXY channel to 20.9%.

If the instrument has a CO₂ sensor installed and if **CO2AIR SETTING** is set to **ON** in User Mode, the CO₂ channel gets set to 400 ppm (0.04% volume). If **CO2AIR SETTING** is set to **OFF** in User Mode, the CO₂ channel is not adjusted during the demand zero.

- 1 . Find a fresh-air environment. This is an environment free of toxic or combustible gases and of normal oxygen content (20.9%).
- 2 . Turn on the unit as described above in “Turning On the GX-3R Pro”.
- 3 . Press and hold AIR. The LCD prompts you to continue holding AIR and the buzzer pulses while you hold the button (if **KEY TONE** is set to **ON** in User Mode).
- 4 . Continue to hold AIR until the LCD prompts you to release it. The GX-3R Pro sets the fresh air readings for all channels. Start up is complete and the unit is now ready for monitoring.

Turning Off the GX-3R Pro

1. Press and hold POWER MODE.
2. TURN OFF appears on the display and the buzzer pulses for about five seconds (if **KEY TONE** is set to **ON** in User Mode).
3. Release the button when TURN OFF disappears from the display.
4. If you plan to leave the instrument off for an extended period of time, see pg.112.

Measuring Mode Operation

When the GX-3R Pro completes its startup sequence, it is in Measuring Mode. In Measuring Mode the GX-3R Pro continuously monitors the sampled atmosphere and displays the target gas concentrations. The GX-3R Pro is considered to be in Normal Operation if there are no alarm indications.

♥♥	S	7:49	🔊	📶	🔋
CH4	%LEL	CO	ppm	H2S	ppm
	0		0		0.0
O2	%	CO2		vol%	
	20.9			0.00	

Heart Symbol: The heart symbol in the upper left corner of the LCD indicates the operation status and blinks when normal. A microprocessor error causes the heart symbol to stop flashing or to disappear.

Check Mark: If **BUMP REMINDER** is set to **ON** and if a bump test is not due, a check mark appears in the upper left corner of the LCD.

“S”: If the instrument is operating in Stealth Mode, an “S” appears at the top of the LCD.

Buzzer Icon: The buzzer icon indicates the buzzer volume. Lines in front of the icon indicate a high buzzer volume. No lines in front of the icon indicates a low buzzer volume.

Bluetooth Icon: The Bluetooth icon flashes when the instrument is trying to pair to a phone. The Bluetooth icon is steadily on when the instrument is paired to a phone. The Bluetooth icon is off when the instrument is not paired and is not trying to pair to a phone.

Backlight: In a low-light environment, press and release either button to turn on the display backlight. See pg.91 to set the backlight time.

Confirmation/Non-Compliance Indicator: If the **BEEP** menu item in User Mode is set to anything other than **OFF**, the GX-3R Pro gives periodic indications to confirm that it’s operating or to indicate a non-compliance (see pg.89 for instructions).

Monitoring an Area

1. Start up the GX-3R Pro as described above in “Start Up” on page 19. It is now in Measuring Mode.

♥♥	S	7:49	🔊	📶	🔋
CH4	%LEL	CO	ppm	H2S	ppm
	0		0		0.0
O2	%	CO2		vol%	
	20.9			0.00	

2. Take the GX-3R Pro to the monitoring area.
3. Wait at least 15 seconds and observe the display for gas readings. If a reading is observed, allow the reading to stabilize to determine the gas concentration(s) present. If you are sampling with an aspirator adapter, see pg.29.

4. If a gas alarm occurs, take appropriate action. See pg.32.
5. Do not expose the GX-3R Pro to rain.
6. The GX-3R Pro's IP 66/68 ratings do not imply that the GX-3R Pro will detect gas during and after exposure to those conditions. If exposure occurs, dry the instrument with a cloth and perform a bump test as described on pg.56.
7. If the GX-3R Pro gets exposed to flammable liquids:
 - a. Wipe the instrument off with a cloth dampened with water.
 - b. Replace the filters as described on pg.104 and pg.106 if they became saturated
 - c. Perform a bump test as described on pg.56.
8. If you suspect that the GX-3R Pro is not operating correctly:
 - a. Take the GX-3R Pro to a fresh air environment and perform a demand zero as described on pg.24.
 - b. Perform a bump test as described on pg.56.

Combustible Gas Detection

There are three issues to keep in mind when monitoring for combustible gas.

Response

The combustible gas sensor responds to any combustible gas. The standard calibrated target gas for the combustible gas channel is methane (CH₄). If the instrument is setup for and calibrated to a different combustible gas, such as hexane or propane, the gas name right above the readings displays as "HC".

Automatic Conversion

The GX-3R Pro can automatically display converted target gas readings if the instrument's calibrated target gas is methane or isobutane. See "Combustible Sensor Target Gas Conversion (HC GAS LIST)" on page 40.

Manual Conversion

You can manually calculate a converted target gas reading using Table 6 below if the instrument's calibrated target gas is methane. The table below lists the conversion factors for several hydrocarbon gases **if the GX-3R Pro is calibrated to methane.**

To use this table, multiply the display reading on the combustible gas channel by the factor in the appropriate row to obtain the actual gas concentration. For example, if you are detecting ethylene and the display reads 10% LEL for the combustible gas channel, you actually have 10% LEL x 0.83 = 8.3% LEL ethylene present.

Table 6: LEL Hydrocarbon Conversion Factors

Gas	LEL Conversion Factor (from CH ₄ Cal.)
Acetone	2.22
Acetylene	1.43
Benzene	2.50
Butadiene	1.52
Cyclopentane	1.45
DME	1.16
Ethane	0.94

Gas	LEL Conversion Factor (from CH ₄ Cal.)
IPA	1.64
Isobutane	1.10
MEK	2.63
Methane	1.00
Methanol	1.82
MIBK	4.00
MMA	3.33

Table 6: LEL Hydrocarbon Conversion Factors

Gas	LEL Conversion Factor (from CH ₄ Cal.)
Ethanol	1.96
Ethyl Acetate	2.86
Ethylene	0.83
Heptane	3.13
Hexane	1.89
Hydrogen	0.95

Gas	LEL Conversion Factor (from CH ₄ Cal.)
Nonane	9.09
Propane	1.12
Propylene	0.97
THF	2.33
Toluene	4.55
Xylene	7.69

Overscale Protection

The GX-3R Pro protects the combustible gas sensor by temporarily turning off the sensor power if levels exceeding 100% LEL are detected. Nevertheless, combustible gas concentrations above 100% LEL can still affect the zero level or calibration of the combustible gas sensor.

CAUTION: *Do not expose the combustible gas sensor to high concentrations of combustible gas such as that from a butane lighter. Exposure to high concentrations of combustible gas may adversely affect the performance of the sensor.*

CAUTION: *Any rapid increase in the combustible gas reading on the combustible gas channel followed by a declining or erratic reading may indicate a gas concentration above the LEL which may be hazardous.*

Damaging Gases

Some gases such as silicone vapors, chlorinated hydrocarbons, and sulphur compounds can contaminate the sensor’s detection elements. This causes sensor damage and/or a reduced response to combustible gas. Make every effort to avoid these gases.

The H₂S scrubber disks protect the combustible sensor from H₂S, but you should avoid other sulphur compounds.

LIMITED HC GAS LIST Alarm

An HC GAS LIST LIMITED alarm can occur at startup or after a calibration.

The combustible gas sensor actually contains 2 separate sensors: a standard catalytic sensor and a backup, poison-resistant sensor that is resistant to sensor poisons like silicone. A LIMITED HC GAS LIST alarm indicates that the standard sensor has a reduced output, possibly due to one or more sensor poisons in the environment, and that the poison-resistant sensor is being used to provide gas readings. The poison-resistant sensor has a limited list of detectable gases. The table shown on pg.40 shows which gases can and cannot be detected after receiving a LIMITED HC GAS LIST alarm.

If your application requires detection of a gas still detectable after a LIMITED HC GAS LIST alarm (like methane or isobutane), there is no need to replace the combustible gas sensor.

However, if your application requires detection of a gas not detectable after a LIMITED HC GAS LIST alarm (like methanol or ethanol), you must replace the combustible gas sensor as soon as possible.

Oxygen-Enriched Atmospheres

The GX-3R Pro is not intended for use in oxygen-enriched atmospheres.

WARNING: *Do not use the GX-3R Pro in an environment whose oxygen concentration is above 21% .*

H₂-Compensated CO Detection

- GX-3R displays CO readings.
- H₂ reading is not displayed but “H2 RICH” appears once the H₂ concentration rises above 2000 ppm.

Interference Information

Some gases interfere with CO, H₂S, and super toxic sensors. For a complete list of these gases, see pg.170.

CO₂ Detection

- A background level of CO₂ exists in fresh air. Table 7 below indicates a typical gas reading in fresh air.

Table 7: Carbon Dioxide Fresh Air Readings

Sensor Range	Approximate Fresh Air Reading
0 - 10.00% volume	0.04% volume
0 - 10,000 ppm	400 ppm

- Performing a demand zero, an auto zero, or an **AIR CAL** will either set to CO₂ channel to 400 ppm (0.04% volume) or exclude the CO₂ channel based on the setting of the **CO2AIR SETTING** User Mode parameter. See pg.94 for more information.

Aspirator Adapter Sampling

The aspirator adapter accessory is used when it is necessary to draw sample from an area that cannot be entered or that must be checked for safety before entry, such as a tank or confined space.

NOTE: The CSA combustible performance certification for the GX-3R Pro does not include the aspirator adapter.

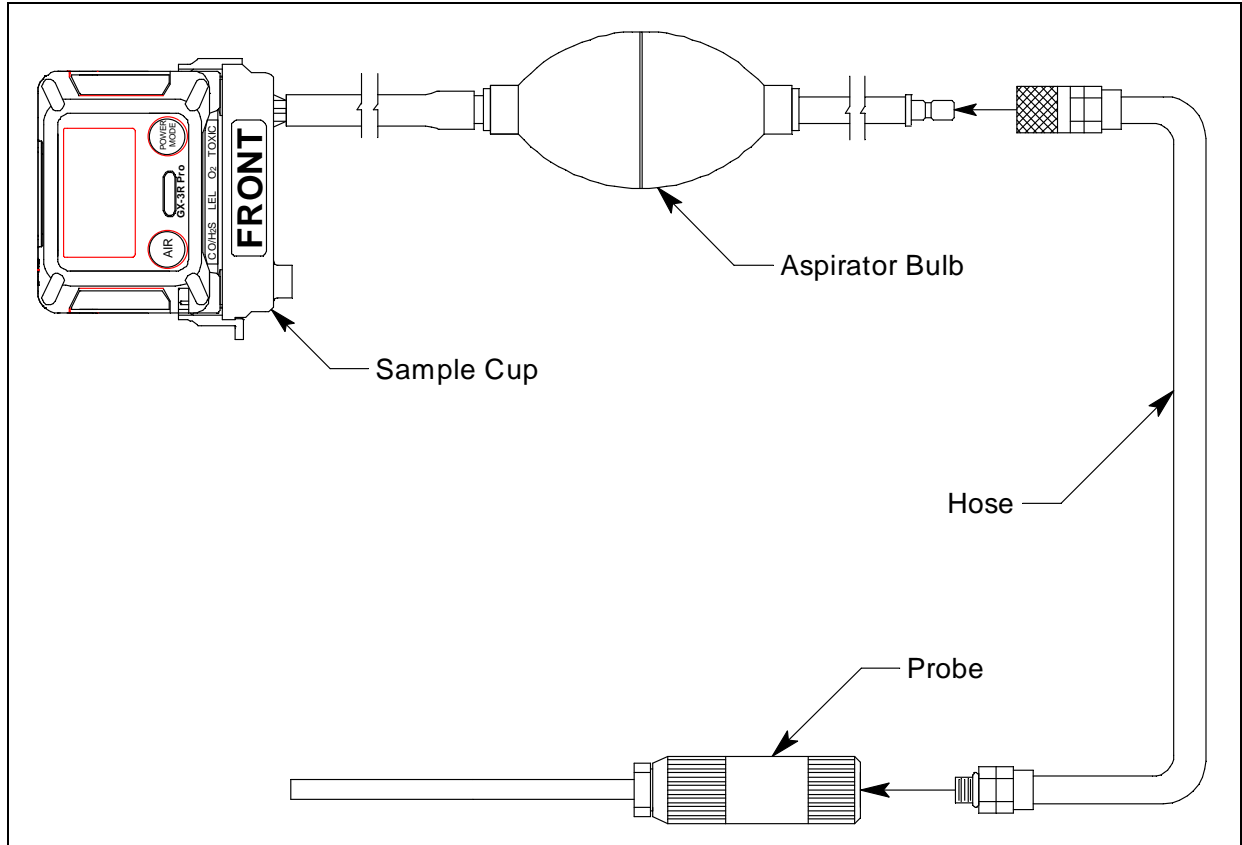

Figure 6: GX-3R Pro Aspirator Adapter

1. Turn on the GX-3R Pro as described on pg.19.
2. Attach the sample cup to the GX-3R Pro. Use the label and imprinting to make sure that the sample cup gets installed in the correct orientation relative to the GX-3R Pro. Be sure the sample cup is pushed on all the way.
3. Screw the probe onto the threaded end of the hose.
4. Attached the hose and probe to the aspirator bulb.
5. Insert the end of the probe into the area to be sampled.
6. Squeeze and release the aspirator bulb 15 times.
7. Monitor the readings and note if any alarms occur. The readings will peak shortly after the last squeeze and may decrease before all the channels can be checked. Use the Peak screen in Display Mode to see the maximum readings for each channel (see pg.39).

NOTE: The peak readings for each channel are saved until a higher peak is recorded, the peak readings are reset, or the instrument is turned off. If a gas is present but the level does not exceed the previous peak level, the previous peak will be displayed on the Peak Screen.

Alarms

This section covers alarm indications in Measuring Mode. It also describes responding to and resetting an alarm condition.

NOTE: False alarms may be caused by radio frequency (RF) or electromagnetic (EMI) interference. Keep the GX-3R Pro away from RF and EMI sources such as radio transmitters or large motors.

Alarm Indications

The GX-3R Pro buzzer sounds an alarm, the LEDs flash, and the vibrator pulses when any sort of alarm condition or failure occurs. If the GX-3R Pro is operating in Stealth Mode, the buzzer does not sound and the vibrator's operation depends on the **VIBRATION** setting in Gas Select Mode's **STEALTH** menu item. See pg.167 for more information.

NOTE: If an alarm condition occurs while you are in Display Mode, the GX-3R Pro automatically returns to the Measuring Mode screen.

The table below summarizes the GX-3R Pro's alarm types and indications.

None of the Man Down alarm indications occur if **MAN DOWN** is set to **OFF** (factory setting) in User Mode. The Panic alarm does not occur if **PANIC** is set to **OFF** (factory setting) in User Mode.

Table 8: Alarm Types and Indications

Alarm Type	Visual Indications	Other Indications
<p>Warning Concentration of gas rises above the Warning setting or falls below the Warning setting for O₂.</p>	<ul style="list-style-type: none"> Affected channel's gas reading flashes and the units field alternates between the units and AL1 Alarm LEDs flash in circle sequence once per second Backlight turns on 	<ul style="list-style-type: none"> High-low tone sounding once per second Vibrator pulses once per second
<p>Alarm Concentration of gas rises above the Alarm setting or falls below the Alarm setting for O₂.</p>	<ul style="list-style-type: none"> Affected channel's gas reading flashes and the units field alternates between the units and AL2 Alarm LEDs flash in circle sequence twice per second Backlight turns on 	<ul style="list-style-type: none"> High-low tone sounding twice per second Vibrator pulses twice per second
<p>Alarm H Concentration of gas rises above the Alarm H setting.</p>	<ul style="list-style-type: none"> Affected channel's gas reading flashes and the units field alternates between the units and AL3 Alarm LEDs flash in circle sequence twice per second Backlight turns on 	<ul style="list-style-type: none"> High-low tone sounding twice per second Vibrator pulses twice per second

Table 8: Alarm Types and Indications

Alarm Type	Visual Indications	Other Indications
<p>TWA or STEL Concentration of CO, H₂S, CO₂, or super toxic gas rises above the TWA or STEL alarm setting.</p>	<ul style="list-style-type: none"> • Affected channel’s gas reading flashes and the units field alternates between the units and TWA or STEL. • Alarm LEDs flash in circle sequence once per second • Backlight turns on 	<ul style="list-style-type: none"> • High-low tone sounding once per second • Vibrator pulses once per second
<p>H2 RICH (for GX-3R Pros with H₂-compensated CO sensor) Concentration of hydrogen rises above 2000 ppm (parts per million).</p>	<ul style="list-style-type: none"> • H2 and RICH alternate in the lower right corner • Alarm LEDs flash twice per second • Backlight turns on 	<ul style="list-style-type: none"> • High-low tone sounding twice per second • Vibrator pulses twice per second
<p>Over Range</p>	<ul style="list-style-type: none"> • Affected channel’s gas reading is replaced by flashing OVER and the units field alternates between the units and OVER. • Alarm LEDs flash in circle sequence twice per second • Backlight turns on 	<ul style="list-style-type: none"> • High-low tone sounding twice per second • Vibrator pulses twice per second
<p>Minus Over Range</p>	<ul style="list-style-type: none"> • Affected channel’s gas reading is replaced by flashing -OVER and the units field alternates between the units and MOVER. • Alarm LEDs flash in circle sequence twice per second • Backlight turns on 	<ul style="list-style-type: none"> • High-low tone sounding twice per second • Vibrator pulses twice per second
<p>Low Battery Warning</p>	<ul style="list-style-type: none"> • The last bar in the battery icon starts flashing 	<p>None</p>
<p>Dead Battery Alarm</p>	<ul style="list-style-type: none"> • Gas readings disappear and FAIL BATTERY appears at the bottom of the LCD • Alarm LEDs flash once per second 	<p>Double pulsing tone once per second</p>
<p>Sensor Failure</p>	<ul style="list-style-type: none"> • FAIL SENSOR appears at the bottom of the LCD and the failed sensor(s) are indicated with FAIL under the gas name. • Alarm LEDs flash once per second 	<p>Double pulsing tone once per second</p>
<p>LIMITED HC GAS LIST</p>	<ul style="list-style-type: none"> • LIMITED HC GAS LIST appears on the screen • Alarm LEDs flash once per second 	<p>Double pulsing tone once per second</p>
<p>Clock Failure</p>	<ul style="list-style-type: none"> • FAIL CLOCK appears at the bottom of the LCD • Alarm LEDs flash once per second 	<p>Double pulsing tone once per second</p>

Table 8: Alarm Types and Indications

Alarm Type		Visual Indications	Other Indications
System Failure		<ul style="list-style-type: none"> • FAIL SYSTEM appears at the bottom of the LCD and an error code displays in the middle of the LCD • Alarm LEDs flash once per second 	Double pulsing tone once per second
Man Down Warning 1 The WARNING 1 TIME defined in User Mode has passed since the instrument detected movement.		<ul style="list-style-type: none"> • Alarm LEDs flash once per second 	Single pulsing tone once per second
Man Down Warning 2 The WARNING 2 TIME defined in User Mode has passed since the instrument detected movement.		<ul style="list-style-type: none"> • Alarm LEDs flash twice per second 	Single pulsing tone twice per second
Man Down Alarm The ALARM TIME defined in User Mode has passed since the instrument detected movement.		<ul style="list-style-type: none"> • MAN DOWN appears at the bottom of the LCD and the gas readings disappear • Alarm LEDs flash in circle sequence twice per second • Backlight turns on 	<ul style="list-style-type: none"> • High-low tone sounding twice per second • Vibrator pulses twice per second
Panic User double taps the instrument.	Pre Alarm	<ul style="list-style-type: none"> • Screen unaffected for 5 seconds • Alarm LEDs flash twice per second 	<ul style="list-style-type: none"> • Single pulsing tone twice per second for 5 seconds
	Main Alarm	<ul style="list-style-type: none"> • PANIC appears at the bottom of the LCD and the gas readings disappear • Alarm LEDs flash in circle sequence twice per second • Backlight turns on 	<ul style="list-style-type: none"> • High-low tone sounding twice per second • Vibrator pulses twice per second

Responding to Alarms

This section describes response to gas, over range, battery, sensor failure, LIMITED HC GAS LIST, clock failure, system failure, man down, and panic alarms.

Responding to Gas Alarms

1. Determine which gas alarm has been activated.
2. Follow your established procedure for an increasing gas condition or a decreasing oxygen condition.
3. Reset the alarm as necessary or allowed.
 - a. If **LATCHING** is set to **ON** (factory setting) in Maintenance Mode, the gas reading must fall below (or rise above for an oxygen low alarm) an alarm setting before you can reset the alarm condition using **POWER MODE** or **AIR**.
 - b. If **LATCHING** is set to **OFF** in Maintenance Mode, the alarm condition automatically resets when the gas reading falls below (or rises above for an oxygen low alarm) an alarm setpoint.

Responding to an H2 RICH Alarm (H₂-Compensated CO Sensor Only)

The H2 RICH alarm automatically clears once the hydrogen level decreases below 2000 ppm (parts per million).

Responding to Over Range Alarms

WARNING: *An over range condition may indicate an extreme combustible gas, toxic gas, or oxygen concentration. Confirm the gas concentration with a different GX-3R Pro or with another gas detecting device.*

CAUTION: *High off-scale readings may indicate an explosive concentration.*

PRUDENCE: *Des lectures élevées hors échelle peuvent indiquer une concentration explosive.*

1. Determine which channel is in alarm.
2. Follow your established procedure for an extreme gas condition.
3. If **LATCHING** is set to **ON** (factory setting) in Maintenance Mode, reset the alarm using POWER MODE or AIR once the alarm condition clears.
4. Calibrate the GX-3R Pro as described on pg.62.
5. If the over range condition continues or if you are not able to successfully calibrate the unit, you may need to replace the sensor that has triggered the over range alarm.
6. If the over range condition continues after you have replaced the sensor, contact RKI Instruments, Inc. for further instructions.

Responding to Battery Alarms

WARNING: *The GX-3R Pro is not operational as a gas monitoring device during a dead battery alarm. Take the Model GX-3R Pro to a non-hazardous area and replace or recharge the batteries as described on pg.100 and pg.102.*

The GX-3R Pro is fully functional during a low battery warning. Proper instrument operation is only guaranteed for 10 minutes but the instrument will operate for 1-2 hours after the start of the alarm. However, only 1-2 hours of operating time remains. The amount of operating time left depends on LCD backlight use and the alarm frequency. Recharge the Li-ion battery pack (pg.102) or replace the alkaline batteries (pg.100) as soon as possible.

NOTE: Alarms and the LCD backlight consume battery power and reduce the amount of operating time remaining.

Responding to Sensor Failure Alarms

1. Determine which sensor triggered the sensor failure alarm.
2. Calibrate the failed sensor, as described on pg.62.
3. If the sensor failure continues or if the sensor could not be calibrated, replace the sensor as described on pg.107
4. If the sensor failure condition continues, contact RKI Instruments, Inc. for further instructions.

Responding to a LIMITED HC GAS LIST Alarm

An HC GAS LIST LIMITED alarm can occur at startup or after a calibration.

- 1 . Press and release POWER MODE to acknowledge the alarm.

The combustible gas sensor actually contains 2 separate sensors: a standard catalytic sensor and a backup, poison-resistant sensor that is resistant to sensor poisons like silicone. A LIMITED HC GAS LIST alarm indicates that the standard sensor has a reduced output, possibly due to one or more sensor poisons in the environment, and that the poison-resistant sensor is being used to provide gas readings. The poison-resistant sensor has a limited list of detectable gases. The table shown on pg.40 shows which gases can and cannot be detected after receiving a LIMITED HC GAS LIST alarm.

If your application requires detection of a gas still detectable after a LIMITED HC GAS LIST alarm (like methane or isobutane), there is no need to replace the combustible gas sensor.

However, if your application requires detection of a gas not detectable after a LIMITED HC GAS LIST alarm (like methanol or ethanol), you must replace the combustible gas sensor as soon as possible.

Responding to Clock Failure Alarms

A clock failure alarm occurs if the unit's internal clock malfunctions. A clock failure alarm might also occur if the battery becomes too drained during storage. See pg.112 for storage information.

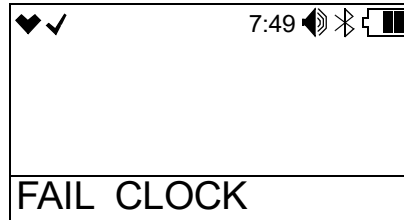

- 1 . Press and release POWER MODE to continue into Measuring Mode.

CAUTION: *If you operate the instrument after a clock failure, data will still be logged but the date/time will be incorrect. Set the date/time as described on pg.94 as soon as possible to ensure logged data uses the correct date/time.*

- 2 . Attempt to set the date using the **DATE** User Mode menu item as described on pg.94.
- 3 . If the date cannot be set correctly, contact RKI Instruments, Inc. as soon as possible.

Responding to System Failure Alarms

1. If a system failure occurs, an error code displays as shown below:

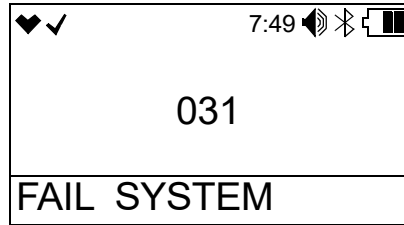

2. The error code meanings are shown in the table below:

Table 9: Error Code Explanation

Error Code	Explanation
000	ROM failure
010	RAM failure
021	FRAM failure
031	FLASH memory failure
080	Acceleration sensor failure
081	PCB failure
082	Temperature sensor failure
083	Bluetooth failure

3. If the error code is anything but 031, the instrument cannot be used. Contact RKI Instruments, Inc. as soon as possible.
If the error code is 031, you may press and release POWER MODE to continue into Measuring Mode if the instrument must be used temporarily.

CAUTION: *There will be no datalogging function if you operate the instrument after a 031 system failure. Contact RKI Instruments, Inc. as soon as possible.*

Responding to a Man Down Warning 1 and Warning 2

The Man Down Warning 1 and Warning 2 alarms occur after the **WARNING 1 TIME** and **WARNING 2 TIME**, respectively, has passed since the last movement of the instrument. See pg.84 for instructions to change these values.

1. Follow your established procedure for a man down warning.
2. To silence the alarm and reset the Man Down clock, move the instrument or press and release POWER MODE.

Responding to a Man Down Alarm

The Man Down Alarm alarms occur after the **ALARM TIME** has passed since the last movement of the instrument. See pg.84 for instructions to change this value.

1. Follow your established procedure for a man down alarm.
2. To silence the alarm and reset the Man Down clock, press and release POWER MODE or AIR. Moving the instrument will not reset the alarm or Man Down clock.

Responding to a Panic Alarm

If the user is in a dangerous situation or feels that others must be alerted to any sort of problem, forcefully tapping the instrument twice will initiate a panic alarm.

1. Press and release POWER MODE or AIR to silence and reset the alarm.

Data Logging

The GX-3R Pro logs Measuring Mode gas readings, alarm data, and calibration data to its internal memory. Logged data can be download it to a computer via the infrared communications port on the front of the unit.

To utilize the GX-3R Pro's downloading capability, you will need the GX-3R Data Logger Management Program and a computer with an infrared port or a USB port that runs one of the following operating systems: Windows 7, Windows 8, or Windows 10. If your computer has an infrared port, then no additional accessories are needed to download data from the GX-3R Pro. If your computer does not have an infrared port but does have a USB port, a USB/IrDA adapter cable can be used to download data from the GX-3R Pro. The GX-3R Data Logger Management Program is available at www.rki.com. The USB/IrDA adapter cable is available from RKI Instruments, Inc.

The data logging capacity depends on how often the GX-3R Pro stores data, how many channels are active, and how often the GX-3R Pro is turned on and off. The table below illustrates how much data logging time is available for the various interval times. It assumes that the unit has four sensors, is only turned on once, and there are no alarm occurrences. The data logging interval time must be set using the GX-3R Data Logger Management Program.

Table 10: Data Logging Capacity

Interval Time	Data Logging Time
10 seconds	10 hours
20 seconds	20 hours
30 seconds	30 hours
1 minute	60 hours
3 minutes	180 hours
5 minutes (factory setting)	300 hours
10 minutes	600 hours

For a complete description of the Data Logger Management Program and procedures for downloading data to a computer, see the GX-3R Data Logger Management Program Operator's Manual.

Chapter 4: Display Mode

This section describes Display Mode which is accessible from Measuring Mode. See Table 11 below for a list of Display Mode's menu items, a short description of each item, and the page number for further description.

Table 11: Display Mode Menu Items

Display Mode Menu Item	Description
PEAK (pg.39)	Displays each sensor's Peak reading.
STEL (pg.39)	Displays the STEL readings (CO, H ₂ S, and CO ₂ /super toxic only).
TWA (pg.40)	Displays the TWA readings (CO, H ₂ S, and CO ₂ /super toxic only).
HC GAS LIST (pg.40) ^A	Change the target gas for the catalytic sensor. <ul style="list-style-type: none"> • CH₄ (methane) • i-C₄H₁₀ (isobutane) • H₂ (hydrogen) • CH₃OH (methanol) • C₂H₂ (acetylene) • C₂H₄ (ethylene) • C₂H₆ (ethane) • C₂H₅OH (ethanol) • C₃H₆ (propylene) • C₃H₆O (acetone) • C₃H₈ (propane) • C₄H₆ (butyne) • C₅H₁₀ (cyclopentane) • C₆H₆ (benzene) • n-C₆H₁₄ (hexane) • C₇H₈ (toluene) • n-C₇H₁₆ (heptane) • C₈H₁₀ (xylene) • n-C₉H₂₀ (nonane) • EtAc (ethyl acetate) • IPA (isopropyl alcohol) • MEK (methyl ethyl ketone) • MMA (methyl methacrylate) • DME (dimethyl ether) • MIBK (methyl isobutyl ketone) • THF (tetrahydrofuran)
USER ID (pg.42) ^C	View and/or change the User ID.
STATION ID (pg.43) ^C	View and/or change the Station ID.
CAL DATA (pg.43) ^D	Displays the last calibration date for each sensor.
BUMP DATA (pg.44) ^E	Displays the last bump test date for each sensor.
DATE (pg.45)	Displays the current date, time, and temperature.
ALARM POINTS (pg.46)	View alarm points
INVERT SELECT (pg.47) ^B	<p>ON: The LCD stays upside down relative to the instrument.</p> <p>AUTO: The LCD automatically flips as the instrument is rotated to remain readable whether the instrument is right side up or upside down.</p> <p>OFF (factory setting): The LCD stays right side up relative to the instrument.</p>

Table 11: Display Mode Menu Items

Display Mode Menu Item	Description
LCD BACK-GROUND (pg.47) ^B	ON: LCD has black background with white characters. OFF (factory setting): LCD has white background with black characters.
BLUETOOTH (pg.48) ^B	ON: Turns Bluetooth functionality on. OFF (factory setting): Turns Bluetooth functionality off.
BUZZER VOLUME (pg.48) ^B	HIGH (factory setting): Buzzer volume is high. LOW: Buzzer volume is low.
LANGUAGE (pg.49) ^F	Change the language of the instrument back to English if something other than English was selected in User Mode.
<p><i>A Only appears if D MODE SETTING is set to ON in User Mode (factory setting) <u>and</u> if CH4 or i-C4H10 is selected for the combustible gas in Gas Select Mode.</i></p> <p><i>B Only appears if D MODE SETTING is set to ON in User Mode (factory setting).</i></p> <p><i>C Only appears if D MODE SETTING is set to ON in User Mode (factory setting) <u>and</u> if ID DISPLAY is set to ON in Maintenance Mode (factory setting is OFF).</i></p> <p><i>D Only appears if CAL REMINDER is set to ON in User Mode (factory setting).</i></p> <p><i>E Only appears if BUMP REMINDER is set to ON in User Mode (factory setting is OFF).</i></p> <p><i>F Only appears if LANGUAGE is set to something other than ENGLISH in Maintenance Mode.</i></p>	

Tips for Using Display Mode

- To enter Display Mode and scroll from one menu item to the next or skip an item when a question is asked, press and release POWER MODE.
- To enter an item, press and release AIR.
- To change a flashing parameter, use AIR. To reverse the direction of movement in a list (ie. from down to up or vice versa):
 - a. Press and hold AIR.
 - b. Immediately press POWER MODE and then release both buttons.
- To exit from an entered-information screen and go back to the main menu, press and release POWER MODE.

NOTE: Each screen displays for 20 seconds. If you do not press a button for 20 seconds, the GX-3R Pro automatically returns to Measuring Mode.

Peak Screen (PEAK)

The peak screen displays the highest (lowest for oxygen) concentrations detected since the GX-3R Pro was turned on. Peak readings are stored in the GX-3R Pro's memory until a higher level is detected (lower for oxygen), the peak reading is cleared, or the GX-3R Pro is turned off.

The lunch break feature enables the GX-3R Pro to save peak readings when it is turned off so it can continue with the same peaks when it is turned on again. See pg.88 for instructions to turn the lunch break feature on (default is off).

To clear the peak readings, do the following:

1. While in Display Mode, press and release POWER MODE until **PEAK** appears.

♥✓	7:49	🔊	📶	🔋	
CH4	%LEL	CO	ppm	H2S	ppm
	12		7		23.0
O2	%	CO2	vol%		
	18.7		5.50		
PEAK					

2. Press and hold AIR until the screen prompts you to release it.

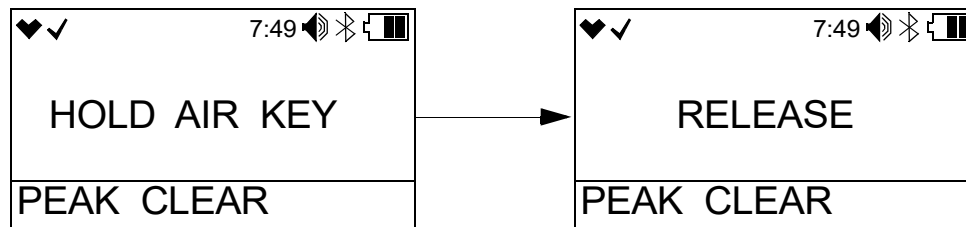

3. The peak readings are reset and the unit returns to the Peak Screen.

If you do not want to clear the peak readings, release AIR before the above screen sequence occurs. The unit returns to the Peak Screen.

STEL Screen (STEL)

The STEL Screen displays the short term exposure limit (STEL) readings for H_2S , CO , CO_2 , and *super toxic only*. The STEL reading is the average reading over the last 15 minutes.

♥✓	7:49	🔊	📶	🔋	
	CO	ppm	H2S	ppm	
		2		3.0	
		CO2	vol%		
			1.50		
STEL					

TWA Screen (TWA)

The TWA Screen displays the time weighted average (TWA) readings for H_2S , CO , CO_2 , and super toxic only.

♥♥	7:49	🔊	📶	🔋
	CO	ppm	H_2S	ppm
		6		5.5
		CO ₂		vol%
				0.75
TWA				

The TWA reading is the average reading *over the last 8 hours*. If 8 hours have not elapsed since the last time the TWA reading was cleared, the average is still calculated over 8 hours. The missing readings are assigned a 0 value. If **LUNCH BREAK** is set to **OFF** (factory setting), the TWA is cleared when the GX-3R Pro is turned off.

If **LUNCH BREAK** is set to **ON**, the GX-3R Pro will remember TWA readings when it is turned off so it can continue them when it is turned on again. See pg.88 for instructions to turn the lunch break feature on (default is off).

Combustible Sensor Target Gas Conversion (HC GAS LIST)

This screen only appears if **D MODE SETTING** in User Mode is set to **ON** (factory setting) and if the instrument's calibrated target gas is CH_4 or iC_4H_{10} (select target gas in Gas Select Mode's **GAS COMBO** item, calibrate with target gas in User Mode's **GAS CAL** item).

The **HC GAS LIST** screen allows you to select a converted target gas based on a CH_4 or iC_4H_{10} calibration. It does not change the calibrated target gas. You must go to Gas Select Mode's **GAS COMB** item to change the calibrated target gas.

Selecting a converted target gas in **HC GAS LIST** (based on a CH_4 or iC_4H_{10} calibration) does not provide the same reading accuracy as selecting a calibrated target gas in Gas Select Mode's **GAS COMBO** item and calibrating with that target gas in User Mode.

Selecting a converted target gas in **HC GAS LIST** does not mean that the combustible gas sensor will respond only to that gas. The combustible gas sensor responds to a number of gases regardless of the target gas selection.

However, if H_2 is selected as the target gas in **HC GAS LIST**, the sensor will not respond to the gases listed with an "x" in the "Available Target Gas Conversions During LIMITED HC GAS LIST Status" column of the table below.

If you select a new converted target gas, the change is saved if you turn the instrument off and on.

Gas	Available Converted Target Gases Based on Calibrated Target Gas (Selected in Gas Select Mode)		Available Converted Target Gases During LIMITED HC GAS LIST Status
	CH4 (methane)	i-C4H10 (isobutane)	
CH4 (methane)	-	x	O
i-C4H10 (isobutane)	O	-	O
H2 (hydrogen)	O	O	O
CH3OH (methanol)	O	O	x
C2H2 (acetylene)	O	O	O
C2H4 (ethylene)	O	O	O
C2H6 (ethane)	O	x	O
C2H5OH (ethanol)	O	O	x
C3H6 (propylene)	O	O	O
C3H6O (acetone)	O	O	x
C3H8 (propane)	O	x	O
C4H6 (butyne)	O	O	O
C5H10 (cyclopentane)	O	O	O
C6H6 (benzene)	O	O	x
n-C6H14 (hexane)	O	O	O
C7H8 (toluene)	O	O	x
n-C7H16 (heptane)	O	O	O
C8H10 (xylene)	O	O	x
n-C9H20 (nonane)	O	O	x
EtAc (ethyl acetate)	O	O	x
IPA (isopropyl alcohol)	O	O	x
MEK (methyl ethyl ketone)	O	O	x
MMA (methyl methacrylate)	O	O	x
DME (dimethyl ether)	O	O	x
MIBK (methyl isobutyl ketone)	O	O	x
THF (tetrahydrofuran)	O	O	x
x = not available O = available			

1. While in Display Mode, press and release POWER MODE until **HC GAS LIST** appears. The current setting displays on the top line.

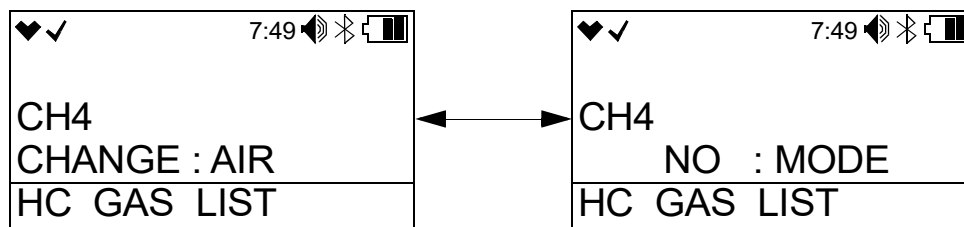

2. Press and release AIR to enter the screen. A cursor appears to the left of the current gas selection.

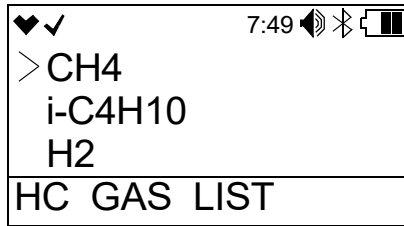

3. Use AIR to scroll through the list of gases.
4. With the cursor next to the desired gas, press and release POWER MODE. The instrument saves the changes and returns to the **HC GAS LIST** screen.
5. The gas formula displays at the bottom of the Measuring Mode screen. The gas selection remains in effect if you turn the instrument off and on again.

User ID Screen (USER ID)

This screen only appears if **D MODE SETTING** in User Mode is set to **ON** (factory setting) and if **ID DISPLAY** in Maintenance Mode is set to **ON** (factory setting is **OFF**).

Use this screen to select a user ID from the 128 user IDs stored in the GX-3R Pro's memory. Before a user ID is selected on a brand new instrument, the user ID is "-----". The factory-installed user IDs have a "U_ID_XXX" format.

The user ID provides a way to identify the GX-3R Pro user during a data logging session.

User IDs can only be selected in this menu item. You must use the GX-3R Datalogging Program to edit the 128 user IDs.

1. After entering Display Mode, press and release POWER MODE until **USER ID** appears.

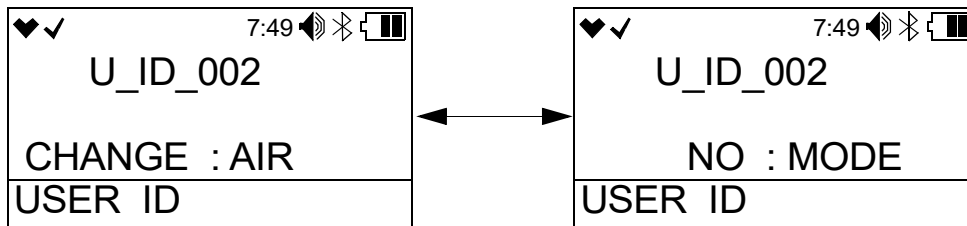

2. To change the User ID, press and release AIR. The current User ID flashes.

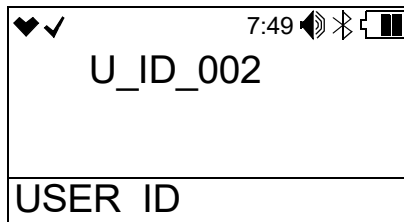

3. Use AIR to scroll to the desired User ID.
4. Press and release POWER MODE to save the User ID and return to the **USER ID** screen in Display Mode.

Station ID Screen (STATION ID)

This screen only appears if **D MODE SETTING** in User Mode is set to **ON** (factory setting) and if **ID DISPLAY** in Maintenance Mode is set to **ON** (factory setting is **OFF**).

Use this screen to select a station ID from the 128 station IDs stored in the GX-3R Pro's memory. Before a station ID is selected on a brand new instrument, the station ID is "-----". The factory-installed station IDs have a "S_ID_XXX" format.

The station ID provides a way to identify the GX-3R Pro location during a data logging session.

User IDs can only be selected in this menu item. You must use the GX-3R Datalogging Program to edit the 128 station IDs.

1. After entering Display Mode, press and release **POWER MODE** until **STATION ID** appears.

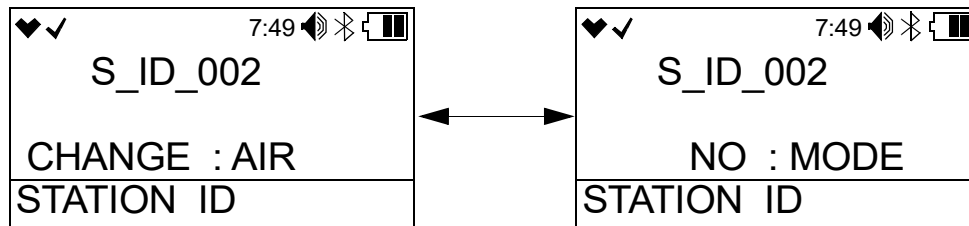

2. To change the Station ID, press and release **AIR**. The current Station ID flashes.

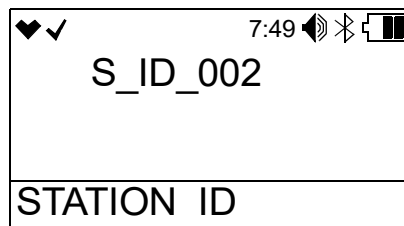

3. Use **AIR** to scroll to the desired Station ID.
4. Press and release **POWER MODE** to save the Station ID and return to the **STATION ID** screen in Display Mode.

Last Successful Calibration Date (CAL DATA)

The **CAL DATA** screen shows the date of each installed sensors' last successful calibration. This screen only appears if **CAL REMINDER** is set to **ON** in User Mode.

1. While in Display Mode, press and release **POWER MODE** until **CAL DATA** appears.

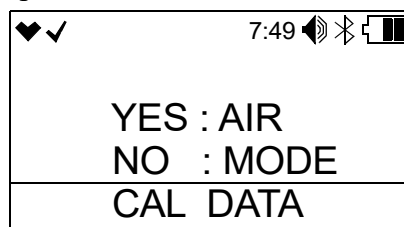

2. Press AIR to enter the **CAL DATA** screen and to scroll through the installed sensors.

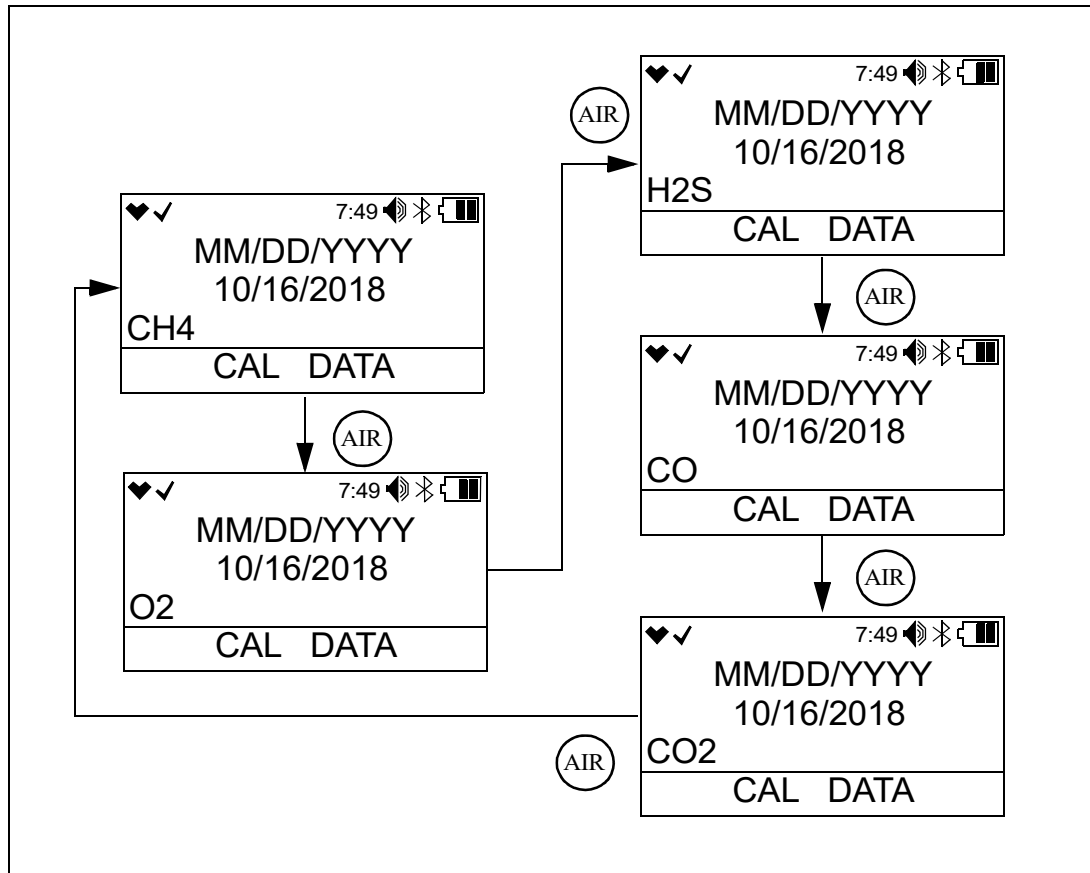

3. When you are done viewing the last calibration date for the sensors, press and release **POWER MODE** to return to the **CAL DATA** screen in Display Mode.

Last Successful Bump Test Date (BUMP DATA)

The **BUMP DATA** screen shows the date of each installed sensors' last successful bump test. This screen only appears if **BUMP REMINDER** is set to **ON** in User Mode.

1. While in Display Mode, press and release **POWER MODE** until **BUMP DATA** appears.

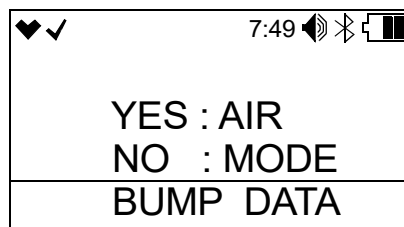

- Press AIR to enter the **BUMP DATA** screen and to scroll through the installed sensors.

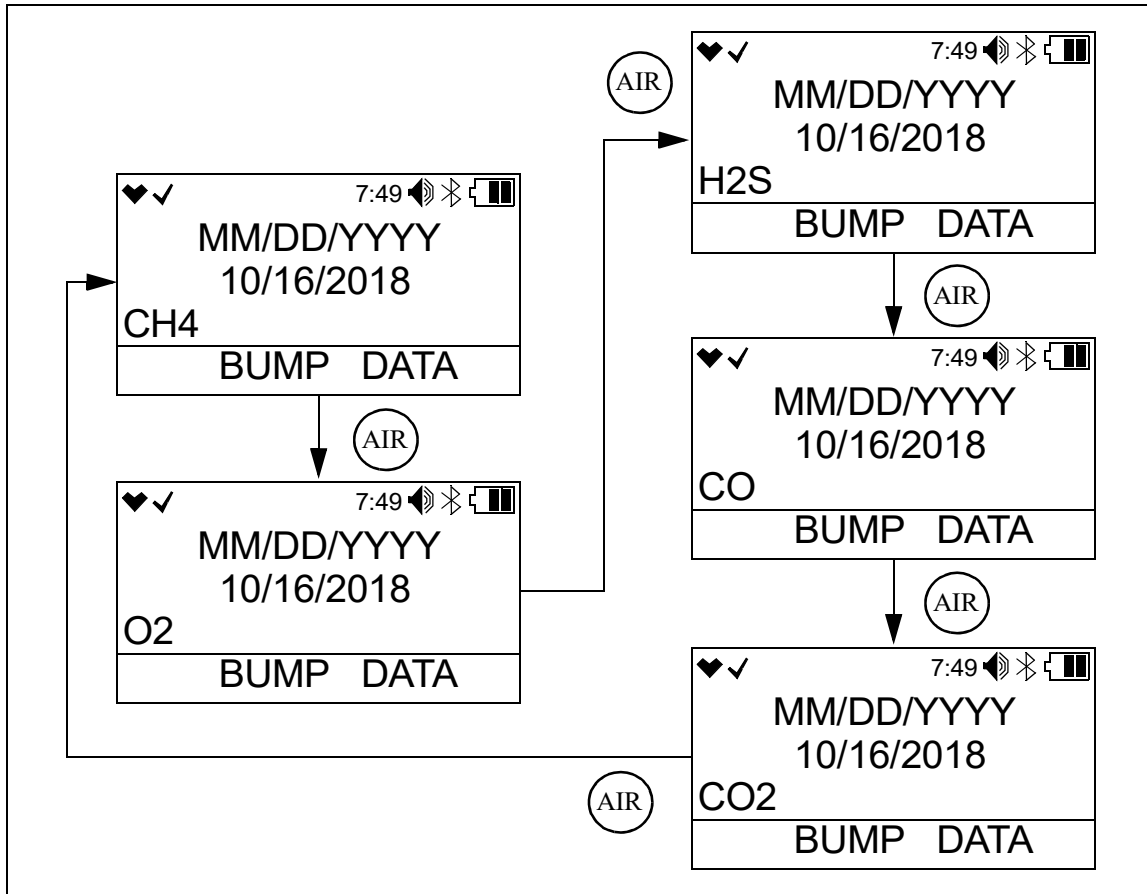

- When you are done viewing the last bump test date for the sensors, press and release POWER MODE to return to the **BUMP DATA** screen in Display Mode.

Date, Time, Temperature Screen (DATE)

The **DATE** screen shows the date and time of the instrument and the temperature of the surrounding area.

- While in Display Mode, press and release POWER MODE until **DATE** appears.

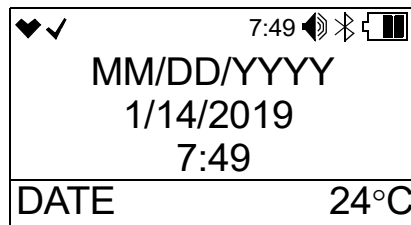

Alarm Points Screen (ALARM POINTS)

The Alarm Points Screen shows the gas alarm settings for all active channels.

1. While in Display Mode, press and release POWER MODE until **ALARM POINTS** appears.

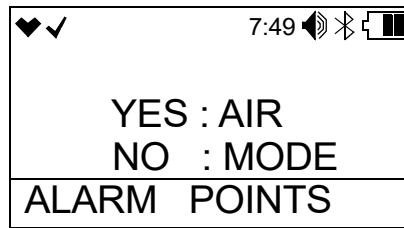

2. Press and release AIR to enter the Alarm Points screen. The Full Scale Settings screen appears and shows full scale settings for each channel.
3. Use AIR to scroll through the Warning, Alarm, Alarm H, STEL, and TWA settings.

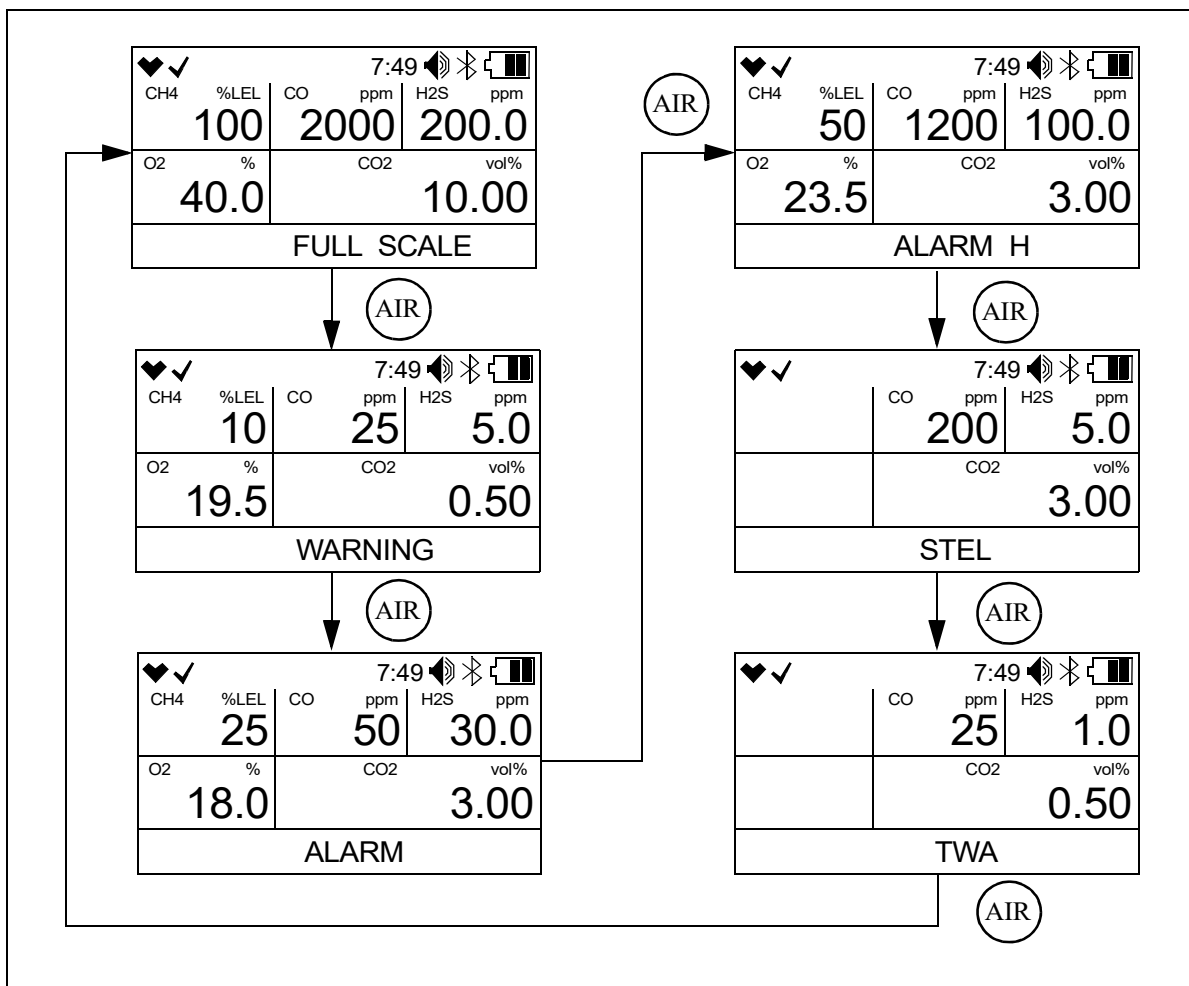

4. While viewing the alarm settings for a particular alarm point, press and release AIR and POWER MODE at the same time to simulate the alarm conditions. The buzzer will sound, the LEDs will flash, and the instrument will vibrate just as it would if the displayed condition was actually happening.
5. Press and release POWER MODE to return to the **ALARM POINTS** item in Display Mode.

Screen Inversion On/Off (INVERT SELECT)

The **INVERT SELECT** screen allows you to turn the screen inversion function on or off. This screen only appears if **D MODE SETTING** in User Mode is set to **ON** (factory setting).

ON: The LCD stays upside down relative to instrument.

AUTO: The LCD automatically flips to remain readable whether the instrument is right side up or upside down.

OFF (factory setting): The LCD stays right side up relative to the instrument.

1. While in Display Mode, press and release **POWER MODE** until **INVERT SELECT** appears. The current setting displays on the top line.

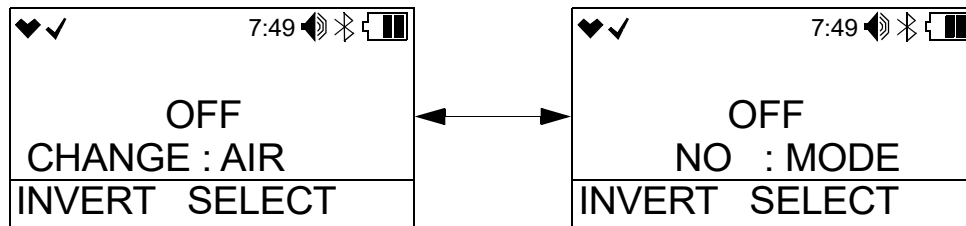

2. Press and release **AIR**. The current setting flashes.
3. Use **AIR** to display the desired setting.
4. Press and release **POWER MODE** to save the setting and return to the **INVERT SELECT** screen.

LCD Color Scheme (LCD BACKGROUND)

The **LCD BACKGROUND** screen allows you to change the appearance of the LCD. This screen only appears if **D MODE SETTING** in User Mode is set to **ON** (factory setting).

ON: LCD has black background with white characters.

OFF (factory setting): LCD has white background with black characters.

1. While in Display Mode, press and release **POWER MODE** until **LCD BACKGROUND** appears. The current setting displays on the top line.

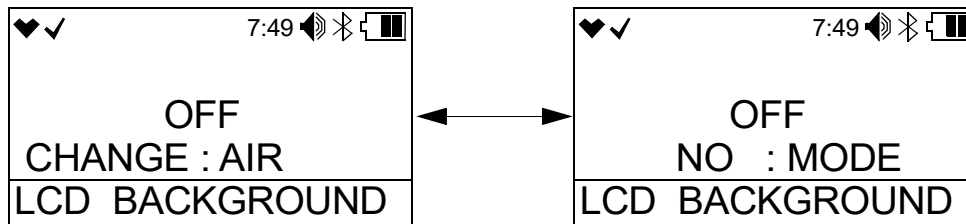

2. Press and release **AIR**. The current setting flashes.
3. Use **AIR** to display the desired setting.
4. Press and release **POWER MODE** to save the setting and return to the **LCD BACKGROUND** screen.

Turning Bluetooth On/Off (BLUETOOTH)

The **BLUETOOTH** screen allows you to turn the GX-3R Pro's Bluetooth functionality on and off. This screen only appears if **D MODE SETTING** in User Mode is set to **ON** (factory setting).

ON: Turns Bluetooth functionality on, allowing for connection to the RK Link app on your phone.

If **BLE Auto Shut Off When Idle**, accessible in the Datalogging or SDM-3R Program, is **selected** (factory setting) and if the GX-3R Pro does not pair to a phone in the first 5 minutes after startup, the GX-3R Pro's Bluetooth gets shut off to conserve battery life.

If **BLE Auto Shut Off When Idle**, accessible in the Datalogging or SDM-3R Program, is **deselected** and if the GX-3R Pro does not pair to a phone, the GX-3R Pro's Bluetooth stays on indefinitely.

OFF (factory setting): Turns Bluetooth functionality off.

1. While in Display Mode, press and release **POWER MODE** until **BLUETOOTH** appears. The current setting displays on the top line.

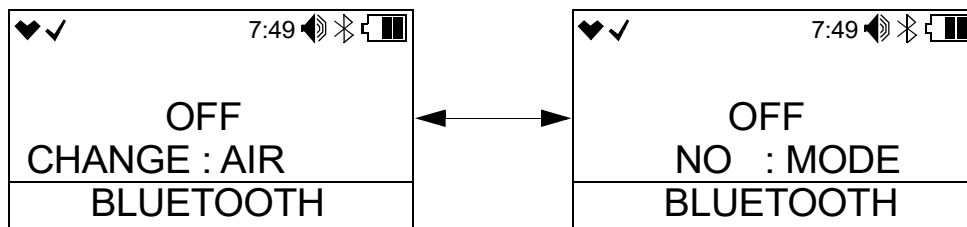

2. Press and release **AIR**. The current setting flashes.
3. Use **AIR** to display the desired setting.
4. Press and release **POWER MODE** to save the setting and return to the **BLUETOOTH** screen.

Adjusting the Buzzer Volume (BUZZER VOLUME)

The **BUZZER VOLUME** screen allows you to adjust the volume of the instrument's buzzer. This screen only appears if **D MODE SETTING** in User Mode is set to **ON** (factory setting).

HIGH (factory setting): Buzzer volume is high.

LOW: Buzzer volume is low.

1. While in Display Mode, press and release **POWER MODE** until **BUZZER VOLUME** appears. The current setting displays on the top line.

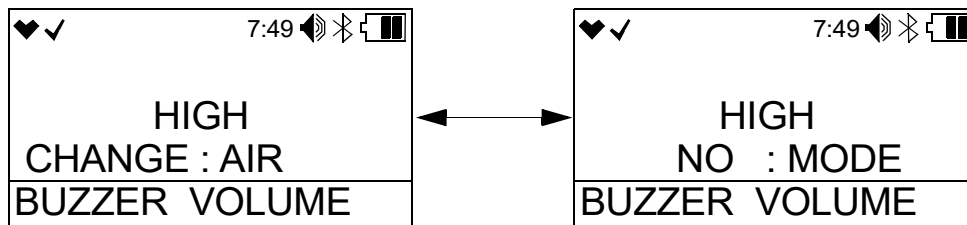

2. Press and release **AIR**. The current setting flashes.
3. Use **AIR** to display the desired setting.
4. Press and release **POWER MODE** to save the setting and return to the **BUZZER VOLUME** screen.

Changing Instrument Language Back to English (LANGUAGE)

This screen only appears if the **LANGUAGE** item in Maintenance Mode is set to something other than **ENGLISH**.

1. While in Display Mode, press and release **POWER MODE** until the **LANGUAGE** screen appears.

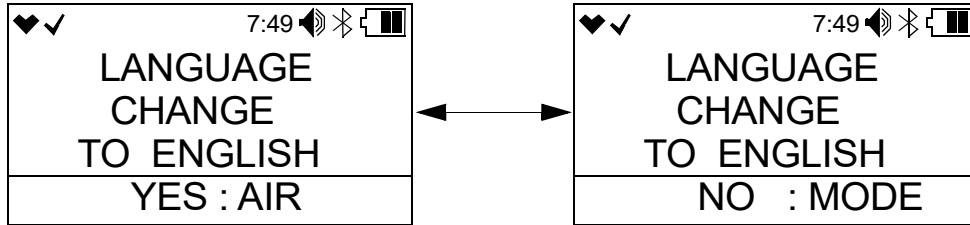

2. Press and release **AIR**.

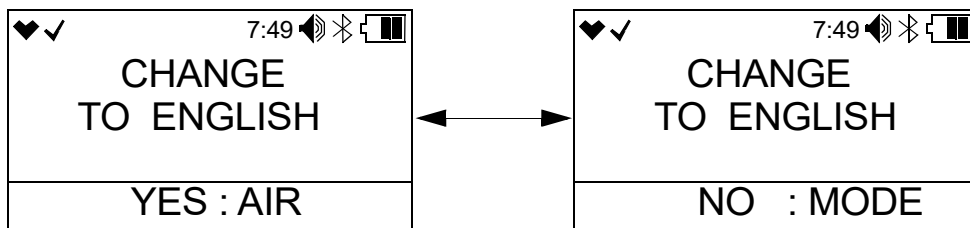

3. Press and release **POWER MODE** to confirm that you want to change the language back to English.

Chapter 5: User Mode and Calibration

Overview

This section describes the GX-3R Pro in User Mode. See Table 12 below for a list of the items found in User Mode, the page that the menu item's instructions can be found on, and a short description of the menu item.

Table 12: User Mode Menu Items

User Mode Menu Item	Description		
BUMP TEST (pg.56)	Perform a bump test.		
	BUMP TEST CYL X	Perform a bump test on the gases selected for Cylinder X (A-E cylinders available).	
	START MEASURE	Begin the warmup sequence and enter Measuring Mode.	
	ESCAPE	Return to BUMP TEST menu item.	
GAS CAL (pg.62)	Perform a fresh air adjustment, perform a span adjustment, change the calibration gas concentration, set the cylinder group.		
	AIR CAL (pg.62)	Perform a fresh air adjustment.	
	CO2 ZERO CAL (pg.63)***	Perform a zero adjustment on the CO ₂ channel using 100% nitrogen.	
	AUTO CAL (pg.65)	AUTO CAL CYL X	Perform an automatic span adjustment on the gases selected for Cylinder X (A-E cylinders available).
		START MEASURE	Begin the warmup sequence and enter Measuring Mode.
		SETTING CAL-P	Set the calibration gas concentration for each gas.
		CYL SETTING	Assign a cylinder (A-E) to each gas. Multiple gases can be assigned to the same cylinder.
		ESCAPE	Return to the AUTO CAL menu item.
ESCAPE	Return to the GAS CAL menu item.		
CAL SETTING (pg.75)	Change calibration parameters.		
	CAL REMINDER (pg.76)	ON (factory setting): The instrument notifies the user upon startup when a calibration is due. Notification type depends on CAL EXPD setting below. OFF: No notification upon startup when a calibration is due.	
	CAL INTERVAL (pg.76)	How often the instrument needs to be calibrated. Options: 1 - 1000 days (factory setting is 90 days)	

Table 12: User Mode Menu Items

User Mode Menu Item	Description		
CAL SETTING (cont'd)	CAL EXPIRED (pg.76)	<p>Defines what action must be taken if a calibration is due upon startup.</p> <p>CONFIRM TO USE (factory setting): Press and release AIR to acknowledge that calibration is due and continue to Measuring Mode.</p> <p>CANNOT USE: Cannot enter Measuring Mode until a successful calibration is performed.</p> <p>NO EFFECT: A screen indicates that calibration is due but warmup sequence continues.</p>	
	CAL CHECK GAS (pg.77)	<p>ALL GAS (factory setting): Calibration dates for all gases are used to determine if calibration is due.</p> <p>4 GAS: Calibration dates for only the standard 4 gases (combustible gas/ O₂/H₂S/CO) are used to determine if calibration is due.</p>	
	ESCAPE	Return to the CAL SETTING menu item in User Mode.	
BUMP SETTING (pg.78)	Change bump test parameters.		
	BUMP PARAMETER (pg.78)	GAS TIME	How long gas is applied during a bump test. Choices: 30 (factory setting), 45 , 60 , 90 seconds
		TOLERANCE	Percentage of calibration gas concentration that the bump test reading must be within in order to pass bump. Options: 10% , 20% , 30% , 40% , 50% (factory setting)
		CAL TIME	How long gas is applied during a calibration. GAS TIME is deducted from this time. Options: 90 (factory setting) or 120 seconds
		AUTO CAL	<p>ON (factory setting): If a bump test fails, a calibration automatically starts.</p> <p>OFF: If a bump test fails, a calibration does not automatically start.</p>
	ESCAPE	Return to the BUMP PARAMETER menu item in BUMP SETTINGS .	
	BUMP REMINDER (pg.80)	<p>ON: The instrument notifies the user upon startup when a bump test is due. Notification type depends on BUMP EXPIRED setting below.</p> <p>OFF (factory setting): No notification upon startup when a bump test is due.</p>	
	BUMP INTERVAL (pg.81)	How often the instrument needs to be bump tested. Options: 0 - 30 days (factory setting is 30 days)	
BUMP EXPIRED (pg.81)	<p>Defines what action must be taken if a bump test is due upon startup.</p> <p>CONFIRM TO USE (factory setting): Press and release AIR to acknowledge that bump test is due and continue to Measuring Mode.</p> <p>CANNOT USE: Cannot enter Measuring Mode until a successful bump test is performed.</p> <p>NO EFFECT: A screen indicates that bump test is due but warmup sequence continues.</p>		

Table 12: User Mode Menu Items

User Mode Menu Item	Description		
BUMP SETTING (cont'd)	BUMP CHECK GAS (pg.82)	<p>ALL GAS (factory setting): Bump test dates for all gases are used to determine if bump test is due.</p> <p>4 GAS: Bump test dates for only the standard 4 gases (combustible gas/ O₂/H₂S/CO) are used to determine if bump test is due.</p>	
	ESCAPE	Return to the BUMP SETTING menu item in User Mode.	
MAN DOWN (pg.82)	Turn the man down and panic alarms on and off. Set the intervals for man down alarms.		
	MAN DOWN (pg.83)	<p>ON: Man down alarm is triggered if the instrument does not detect motion during time period defined in WARNING 1 TIME, WARNING 2 TIME, and ALARM TIME below.</p> <p>OFF (factory setting): No man down alarm triggered.</p>	
	PANIC (pg.83)	<p>ON: Panic alarm can be triggered.</p> <p>OFF (factory setting): Panic alarm cannot be triggered.</p>	
	MAN DOWN TIME (pg.84)	ALARM TIME ≥ WARNING 2 TIME ≥ WARNING 1 TIME	
		WARNING 1 TIME	The amount of time that passes between a man down detection and the first warning alarm. Factory setting is 60 seconds.
		WARNING 2 TIME	The amount of time that passes between a man down detection and the second warning alarm. Factory setting is 75 seconds.
ALARM TIME		The amount of time that passes between a man down detection and a man down alarm. Factory setting is 90 seconds.	
ESCAPE	Return to the MAN DOWN menu item.		
ALARM SETTING (pg.85)	Set alarm points for all channels (WARNING, ALARM, ALARM H, STEL, TWA) or reset all alarms to their default settings.		
LUNCH BREAK (pg.88)	<p>ON: Lunch break feature is on. At startup, instrument asks if you want to resume TWA and PEAK readings.</p> <p>OFF (factory setting): Lunch break feature is off. Instrument resets TWA and PEAK readings every time it's turned on.</p>		

Table 12: User Mode Menu Items

User Mode Menu Item	Description	
CONFIRMATION (pg.89)	Set confirmation beep parameters.	
	BEEP SELECT (pg.89)	<p>LED: LEDs flash and instrument vibrates based on interval defined in BEEP INTERVAL to confirm instrument is still operating.</p> <p>BUZZER: Buzzer sounds and instrument vibrates based on interval defined in BEEP INTERVAL to confirm instrument is still operating.</p> <p>LED+BUZZER: LEDs flash, buzzer sounds, and instrument vibrates based on interval defined in BEEP INTERVAL to confirm instrument is still operating.</p> <p>BUMP/CAL: LEDs flash based on interval defined in BEEP INTERVAL if bump test or calibration is due.</p> <p>ALARM ALERT: LEDs flash based on interval defined in BEEP INTERVAL if instrument goes into a gas alarm.</p> <p>BUMP/CAL/ALARM: LEDs flash based on interval defined in BEEP INTERVAL if a) bump test is due, b) calibration is due, or c) instrument goes into a gas alarm.</p> <p>OFF (factory setting): No alerts to confirm instrument is still operating or that a bump test or calibration are due.</p>
	BEEP INTERVAL (pg.90)	<p>Confirmation alert interval. Confirmation type defined in BEEP SELECT.</p> <p>Options: 0.5 minute and 1 to 99 minutes in 1 minute increments. Factory setting is 5 minutes.</p>
	ESCAPE	Return to the CONFIRMATION menu item in User Mode.
AUTO BACKLIGHT (pg.91)	<p>ON (factory setting): The instrument's backlight automatically turns on in a low light environment.</p> <p>OFF: The instrument's backlight does not automatically turn on in a low light environment.</p>	
BACKLIGHT TIME (pg.91)	<p>How long the back light stays on after the last button press.</p> <p>Options: 0 - 255 seconds or OFF. The factory setting is 30 seconds.</p>	
KEY TONE (pg.92)	<p>ON (factory setting): Buzzer sounds when a button is pressed.</p> <p>OFF: Buzzer does not sound when a button is pressed.</p>	
D MODE SETTING (pg.92)	<p>OFF: LIST, USER ID, STATION ID, INVERT SELECT, LCD BACKGROUND, BLUETOOTH, BUZZER VOLUME, and LANGUAGE items do not appear in Display Mode.</p> <p>ON (factory setting): LIST, INVERT SELECT, LCD BACKGROUND, BLUETOOTH, BUZZER VOLUME, and LANGUAGE items appear in Display Mode. USER ID and STATION ID screens appear if ID DISPLAY in Maintenance Mode is also set to ON.</p>	
ZERO SUPPRESS (pg.93)*	<p>ON (factory setting): Not intended for field adjustment. The suppression values are:</p> <p>Combustible Gas: 2% LEL</p> <p>O₂: 0.5% volume</p> <p>H₂S: 0.3 ppm</p> <p>CO: 2 ppm</p> <p>CO₂: 0 ppm</p> <p>HCN: 0.5 ppm</p> <p>NH₃: 4 ppm</p> <p>NO₂: 0.30 ppm</p> <p>PH₃: 0.02 ppm</p> <p>SO₂: 0.20 ppm</p>	

Table 12: User Mode Menu Items

User Mode Menu Item	Description
ZERO FOLLOWER (pg.93)**	Not intended for field adjustment. The default setting is ON for every channel except oxygen. Oxygen channel does not support zero follower functionality.
IR UNIT SELECT (pg.93)***	Select the units for the IR CO ₂ sensor. Options: vol% or ppm
CO2AIR SETTING (pg.94)***	ON : CO ₂ channel is set to 400 ppm (0.04% volume) during a demand zero, auto zero, or AIR CAL . OFF (factory setting) : CO ₂ channel is not adjusted during a demand zero, auto zero, or AIR CAL .
DATE (pg.94)	Set the current date and time.
DATE FORMAT (pg.95)	MM/DD/YYYY (factory setting) : month/day/year YYYY/MM/DD : year/month/day DD/MM/YYYY : day/month/year
LANGUAGE (pg.95)	Set the instrument language. Options: English (factory setting), Japanese, Italian, Spanish, German, French, Portuguese, Russian, Korean, Chinese (TC)
USER PASSWORD (pg.96)	ON : User Mode access is password-protected. Factory-set password is 0405 . OFF (factory setting) : User Mode access is not password-protected.
ROM/SUM (pg.96)	View the firmware information for the GX-3R Pro's sensor board and main board.
RADIO STANDARD (pg.97)	Approval numbers for radio agencies.
START MEASURE (pg.98)	Press and release POWER MODE to begin the warmup sequence and enter Measuring Mode.
<p>* Only appears if DISP ZERO SUP is set to ON in Maintenance Mode. ** Only appears if DISP ZERO FLWR is set to ON in Maintenance Mode. *** Only appears in units with a CO₂ sensor installed.</p>	

Entering User Mode

WARNING: *The GX-3R Pro is not in operation as a gas detector while in User Mode.*

1. Take the GX-3R Pro to a non-hazardous location and turn it off if it is on.
2. Press and hold AIR, then press and hold POWER MODE. Release the buttons when you hear a beep.

3. The screen that appears depends on the setting of User Mode's **USER PASSWORD** item.

If **USER PASSWORD** is set to **OFF** (factory setting), continue with Step 6.

If **USER PASSWORD** is set to **ON**, continue with Step 4.

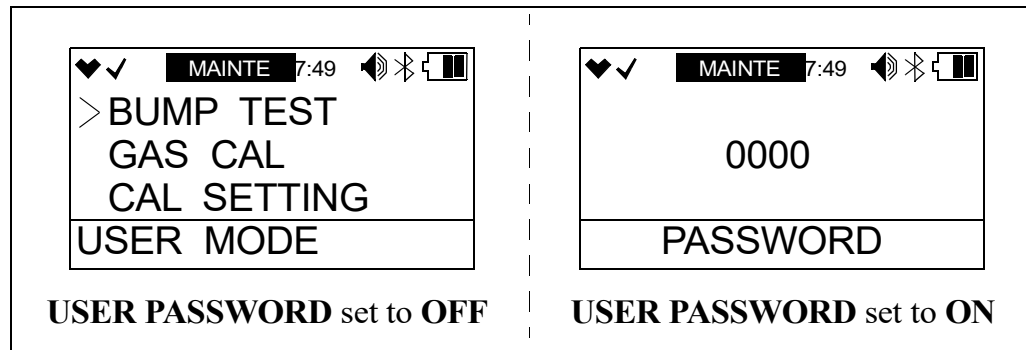

4. If **USER PASSWORD** in User Mode is set to **ON**, a password screen appears and the first digit flashes.
5. Use AIR to select each password number then press POWER MODE to save it and move on to the next number. To go back a number, press and hold AIR and POWER MODE for a few seconds. To reverse the direction of change (ie. from increasing to decreasing or vice versa):
- Press and hold AIR.
 - Immediately press POWER MODE and then release both buttons.
6. The User Mode menu displays.



7. **MAINTENANCE** at the top of the screen indicates that the GX-3R is in User Mode.
8. Use AIR to move through the User Mode menu items.

Tips for Using User Mode

- To scroll from one menu item to the next, press and release AIR. To reverse the scrolling direction:
 - Press and hold AIR.
 - Immediately press POWER/MODE and then release both buttons.
 - The scrolling direction returns to the original direction when you exit and reenter a menu.
- To skip an item when a question is asked, press and release AIR.
- To enter an item and to save any changes, press and release POWER MODE.
- To change a flashing parameter, press and release AIR. To reverse the direction of change (ie. from increasing to decreasing or vice versa):
 - Press and hold AIR.
 - Immediately press POWER MODE and then release both buttons.

- To exit an entered menu item without saving a change, press and hold AIR and POWER MODE for a few seconds.

Performing a Bump Test (BUMP TEST)

Bump test the instrument before each day's use with a known concentration of each target gas. The instrument does not need to be calibrated unless it does not pass the bump test.

To bump test the GX-3R Pro, you will need:

- Known calibrating samples of the gases being detected.

Table 13: Calibration Gas Concentration Limits

Channel	Min. Cal. Gas Concentration	Max. Cal. Gas Concentration
Combustible Gas	5% LEL	75% LEL
Oxygen	0.0%	18.0%
Hydrogen Sulfide	1.0 ppm	200.0 ppm
Carbon Monoxide	15 ppm	2,000 ppm
Ammonia	8 ppm	400 ppm
Carbon Dioxide (0 - 10,000 ppm)	3,000 ppm	9,000 ppm
Carbon Dioxide (0 - 10.00% vol)	1.00% vol	4.00% vol
Hydrogen Cyanide	0.9 ppm	30.0 ppm
Nitrogen Dioxide	0.50 ppm	20.00 ppm
Phosphine	0.05 ppm	20.00 ppm
Sulfur Dioxide	0.50 ppm	100.00 ppm

- A 0.25 LPM fixed flow regulator
 - Non-absorbent tubing
 - Calibration cup
1. Confirm that the GX-3R Pro's calibration gas values match the concentrations listed on the calibration gas cylinder(s) as described on pg.71.
 2. Confirm that your cylinder selections are appropriate as described on pg.73.

3. Install the calibration cup onto the GX-3R Pro. Use the label and imprinting to make sure that the calibration cup gets installed in the correct orientation relative to the GX-3R Pro. Be sure the calibration cup is pushed on all the way.

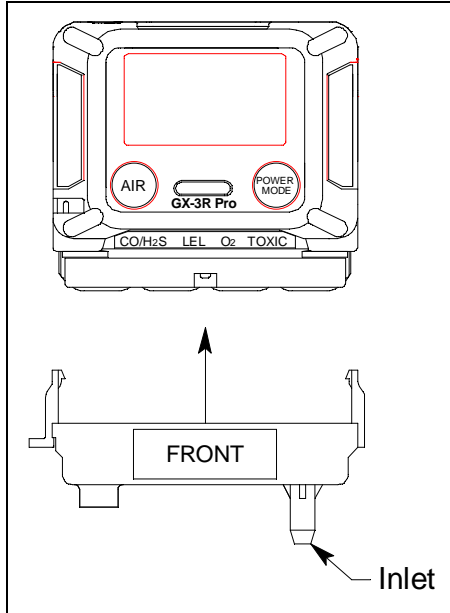

Figure 7: Calibration Cup Installation

4. Use the tubing to connect the regulator to the inlet of the calibration cup.
5. While in User Mode, use AIR to place the cursor next to **BUMP TEST**.



6. Press and release POWER MODE. The display shows the gases assigned to Cylinder A and their assigned calibration values (see pg.71 if the calibration values do not match the calibration gas cylinder's concentrations).

♥✓	MAINT	7:49	🔊	📶	🔋
CH4	%LEL	CO	ppm	H2S	ppm
	50		50		25.0
O2	%				
	12.0				
BUMP TEST		CYLINDER A			

7. If necessary, use AIR to scroll to the Bump screen for the gas(es) you want to bump test. As shipped from the factory, the standard 4 gases (combustible gas, O₂, CO, and H₂S) are assigned to Cylinder A. If a H₂-compensated CO sensor is installed, H₂ is assigned to Cylinder D but there is no reason to bump test the H₂ response. Toxic sensors are assigned to Cylinder D or Cylinder E.
8. Make sure the GX-3R Pro has been turned on for at least 45 seconds before continuing.
9. For toxic gas cylinders (like cylinders containing H₂S), it is important to vent the regulator while installing it onto the cylinder. Venting the regulator during installation helps prevent air from getting into the cylinder and degrading the gas. Open the regulator by turning the knob counterclockwise and install it onto the cylinder.

- 10 . With the appropriate Bump screen displayed, press and release POWER MODE.
- 11 . The gas readings flash, the bottom of the screen indicates “BUMP TEST” and “APPLY GAS”, and the top of the screen counts down from the time defined in **BUMP SETTING\BUMP PARAMETER\GAS TIME**.

MAINTENANCE		30	[Speaker Icon]		[Battery Icon]
CH4	%LEL	CO	ppm	H2S	ppm
	0		0		0.0
O2	% 20.9				
BUMP TEST			APPLY GAS		

NOTE: To back out of the gas application screen without performing the bump test, press and release AIR and POWER MODE together.

- 12 . At the end of the countdown, the instrument analyzes the results. Follow the flow chart to determine the bump test outcome.

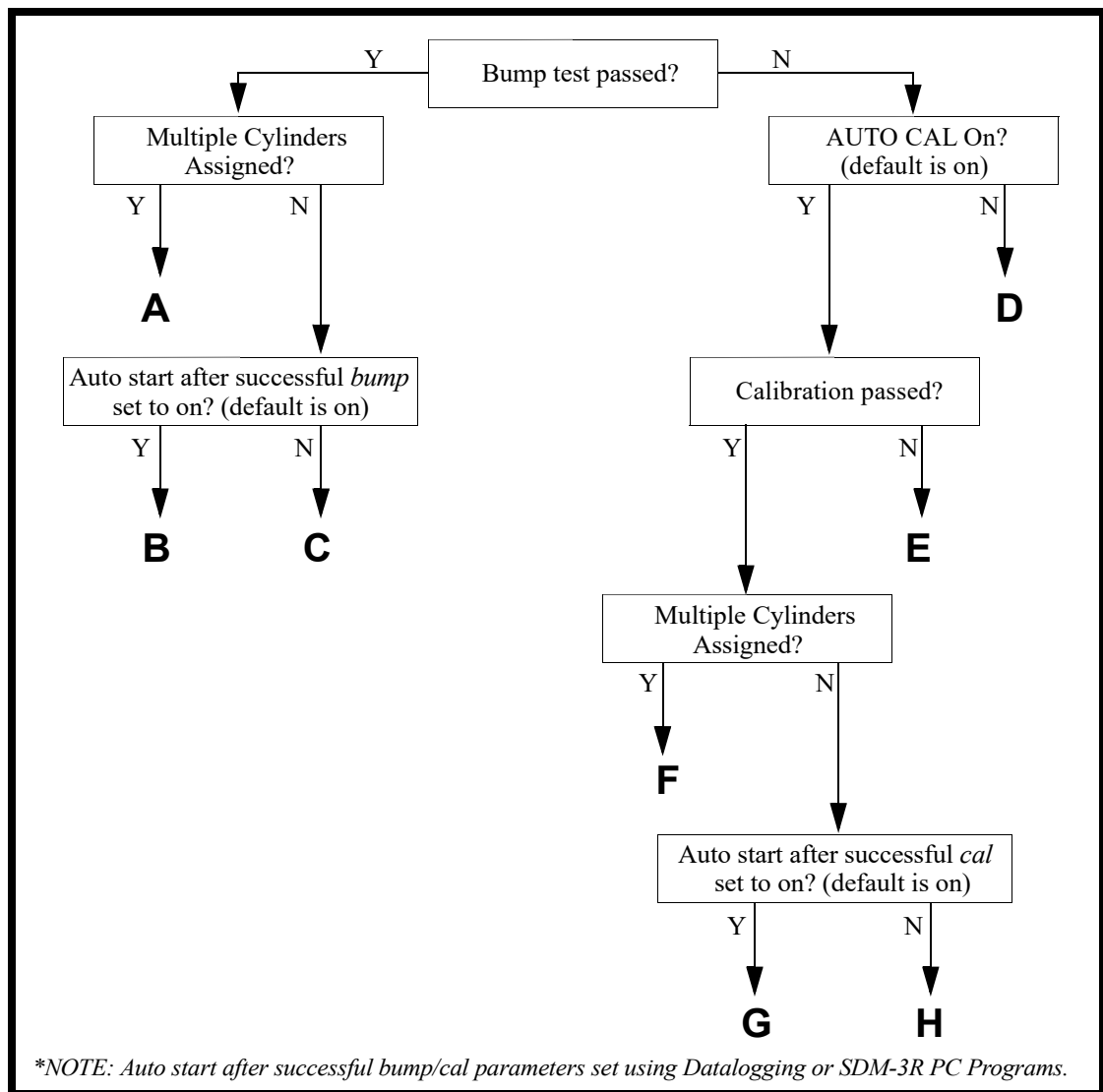
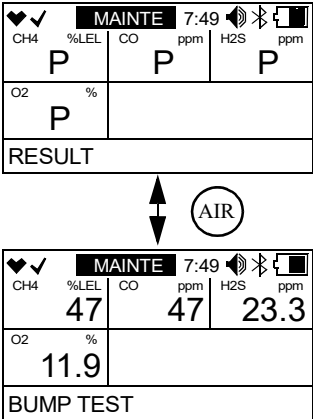
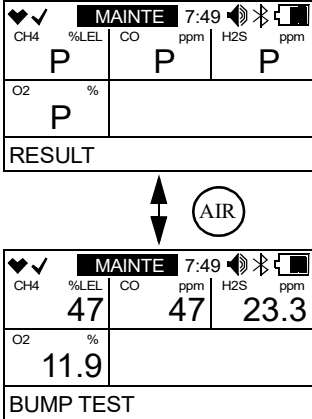
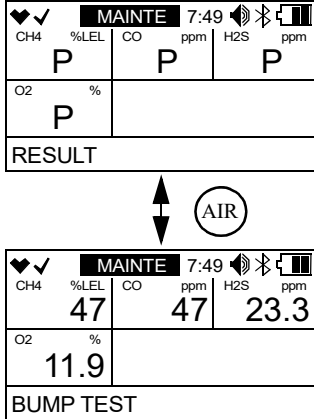
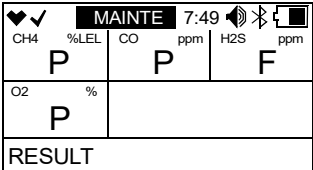
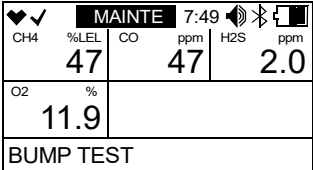
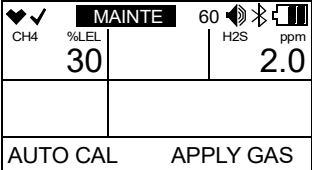
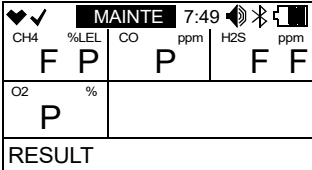
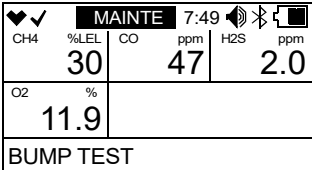
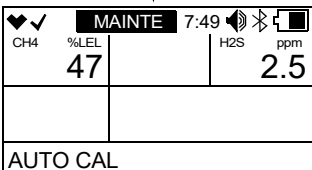
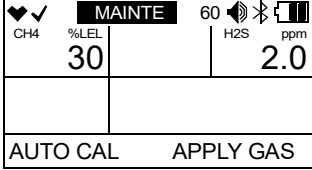
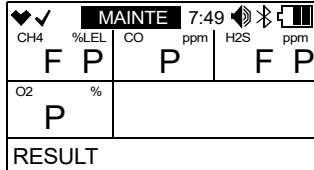
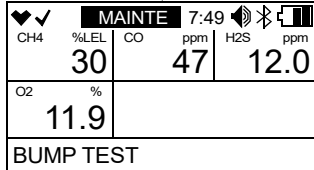
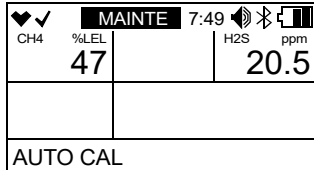





Figure 8: Bump Test Flow Chart

Option A from Flow Chart	Option B from Flow Chart	Option C from Flow Chart
<ul style="list-style-type: none"> Bump test passed Multiple cylinders assigned 	<ul style="list-style-type: none"> Bump test passed One cylinder assigned Auto Start After Successful Bump set to ON (factory setting) 	<ul style="list-style-type: none"> Bump test passed One cylinder assigned Auto Start After Successful Bump set to OFF (factory setting is ON)
<p>1. The instrument indicates that all channels passed the bump test. Use AIR to scroll between the bump test results and the bump test gas readings.</p>  <p>2. Close the regulator.</p> <p>3. Press and release POWER MODE to move to the BUMP CYL X screen for the next cylinder.</p> <p>4. Unscrew the regulator from the first cylinder and screw it into the next cylinder.</p> <p>5. Repeat Step 9 through Step 12.</p> <p>6. After the last cylinder is bump tested, press and release POWER MODE to go to the START item in the BUMP menu.</p> <p>7. Press and release POWER MODE to enter Measuring Mode.</p>	<p>1. The instrument indicates that all channels passed the bump test. Use AIR to scroll between the bump test results and the bump test gas readings.</p>  <p>2. Close the regulator.</p> <p>3. Unscrew the regulator.</p> <p>4. Remove the calibration cup.</p> <p>5. Press and release POWER MODE to enter Measuring Mode.</p>	<p>1. The instrument indicates that all channels passed the bump test. Use AIR to scroll between the bump test results and the bump test gas readings.</p>  <p>2. Close the regulator.</p> <p>3. Unscrew the regulator.</p> <p>4. Remove the calibration cup.</p> <p>5. Press and release POWER MODE to return to the START item in the BUMP menu.</p> <p>6. Press and release POWER MODE to enter Measuring Mode.</p>

Option D from Flow Chart	Option E from Flow Chart	Option F from Flow Chart
<ul style="list-style-type: none"> Bump test failed A-CAL set to OFF (factory setting is ON) 	<ul style="list-style-type: none"> Bump test failed A-CAL set to ON (factory setting) Calibration failed 	<ul style="list-style-type: none"> Bump test failed A-CAL set to ON (factory setting) Calibration passed Multiple cylinders assigned
<p>1. The instrument shows which channels passed or failed the bump test. The LEDs flash and the buzzer sounds. Use AIR to scroll between the results and the readings.</p>   <p>2. Close the regulator. 3. Unscrew the regulator. 4. Remove the calibration cup. 5. Press and release POWER MODE to return to the BUMP CYLA item in the BUMP menu. 6. Use AIR to scroll to START and press and release POWER MODE to enter Measuring Mode. 7. Calibrate the GX-3R Pro as soon as possible.</p>	<p>1. A calibration immediately and automatically starts. Continue to apply the calibration gas.</p> <p>2. The calibration time is the difference between the GAS TIME and the CAL TIME values defined in the BUMP SET/SETTINGS item in User Mode.</p>  <p>3. The instrument shows which channels passed or failed the bump test/calibration. The LEDs flash and the buzzer sounds. Use AIR to scroll between the results and the readings.</p>    <p>4. Close the regulator. 5. Unscrew the regulator. 6. Remove the calibration cup. 7. Press and release POWER MODE to return to the BUMP CYLA item in the BUMP menu. 8. Use AIR to scroll to START and press and release POWER MODE to enter Measuring Mode.</p>	<p>1. A calibration immediately and automatically starts. Continue to apply the calibration gas.</p> <p>2. The calibration time is the difference between the GAS TIME and the CAL TIME values defined in the BUMP SET/SETTINGS item in User Mode.</p>  <p>3. The instrument shows which channels passed or failed the bump test/calibration. Use AIR to scroll between the results and the readings.</p>    <p>4. Close the regulator. 5. Press and release POWER MODE to move to the BUMP CYL X screen for the next cylinder. 6. Unscrew the regulator from the first cylinder and screw it into the next cylinder. 7. Repeat Step 9 through Step 12. 8. After the last cylinder is bump tested, press and release POWER MODE to go to the START item in the BUMP menu. 9. Press and release POWER MODE to enter Measuring Mode.</p>

Option G from Flow Chart	Option H from Flow Chart																																																																																																																																																																																																																																																
<ul style="list-style-type: none"> • Bump test failed • A-CAL set to ON (factory setting) • Calibration passed • One cylinder assigned • Auto Start After Successful Cal set to ON (factory setting) 	<ul style="list-style-type: none"> • Bump test failed • A-CAL set to ON (factory setting) • Calibration passed • One cylinder assigned • Auto Start After Successful Cal set to OFF (factory setting is ON) 																																																																																																																																																																																																																																																
<ol style="list-style-type: none"> 1. A calibration immediately and automatically starts. Continue to apply the calibration gas. 2. The calibration time is the difference between the GAS TIME and the CAL TIME values defined in the BUMP SET\SETTINGS item in User Mode. <div data-bbox="407 653 716 825" style="border: 1px solid black; padding: 5px; margin: 10px 0;"> <table style="width: 100%; border-collapse: collapse;"> <tr> <td style="text-align: center;">♥✓</td> <td style="text-align: center;">MAINT</td> <td style="text-align: center;">60</td> <td style="text-align: center;">🔊</td> <td style="text-align: center;">📶</td> <td style="text-align: center;">🔋</td> </tr> <tr> <td style="font-size: small;">CH4</td> <td style="font-size: small;">%LEL</td> <td style="font-size: small;">CO</td> <td style="font-size: small;">H2S</td> <td style="font-size: small;">ppm</td> <td style="font-size: small;">ppm</td> </tr> <tr> <td style="text-align: center;">30</td> <td></td> <td></td> <td></td> <td style="text-align: center;">2.0</td> <td></td> </tr> <tr> <td colspan="3" style="text-align: center;">AUTO CAL</td> <td colspan="3" style="text-align: center;">APPLY GAS</td> </tr> </table> </div> <ol style="list-style-type: none"> 3. The instrument shows which channels passed or failed the bump test/calibration. Use AIR to scroll between the results and the readings. <div data-bbox="407 947 716 1119" style="border: 1px solid black; padding: 5px; margin: 10px 0;"> <table style="width: 100%; border-collapse: collapse;"> <tr> <td style="text-align: center;">♥✓</td> <td style="text-align: center;">MAINT</td> <td style="text-align: center;">7:49</td> <td style="text-align: center;">🔊</td> <td style="text-align: center;">📶</td> <td style="text-align: center;">🔋</td> </tr> <tr> <td style="font-size: small;">CH4</td> <td style="font-size: small;">%LEL</td> <td style="font-size: small;">CO</td> <td style="font-size: small;">ppm</td> <td style="font-size: small;">H2S</td> <td style="font-size: small;">ppm</td> </tr> <tr> <td style="text-align: center;">F</td> <td style="text-align: center;">P</td> <td style="text-align: center;">P</td> <td></td> <td style="text-align: center;">F</td> <td style="text-align: center;">P</td> </tr> <tr> <td style="font-size: small;">O2</td> <td style="font-size: small;">%</td> <td colspan="4"></td> </tr> <tr> <td style="text-align: center;">P</td> <td></td> <td colspan="4"></td> </tr> <tr> <td colspan="6" style="text-align: center;">RESULT</td> </tr> </table> </div> <div style="text-align: center; margin: 5px 0;">  </div> <div data-bbox="407 1182 716 1354" style="border: 1px solid black; padding: 5px; margin: 10px 0;"> <table style="width: 100%; border-collapse: collapse;"> <tr> <td style="text-align: center;">♥✓</td> <td style="text-align: center;">MAINT</td> <td style="text-align: center;">7:49</td> <td style="text-align: center;">🔊</td> <td style="text-align: center;">📶</td> <td style="text-align: center;">🔋</td> </tr> <tr> <td style="font-size: small;">CH4</td> <td style="font-size: small;">%LEL</td> <td style="font-size: small;">CO</td> <td style="font-size: small;">ppm</td> <td style="font-size: small;">H2S</td> <td style="font-size: small;">ppm</td> </tr> <tr> <td style="text-align: center;">30</td> <td></td> <td style="text-align: center;">47</td> <td></td> <td style="text-align: center;">12.0</td> <td></td> </tr> <tr> <td style="font-size: small;">O2</td> <td style="font-size: small;">%</td> <td colspan="4"></td> </tr> <tr> <td style="text-align: center;">11.9</td> <td></td> <td colspan="4"></td> </tr> <tr> <td colspan="6" style="text-align: center;">BUMP TEST</td> </tr> </table> </div> <div style="text-align: center; margin: 5px 0;">  </div> <div data-bbox="407 1421 716 1593" style="border: 1px solid black; padding: 5px; margin: 10px 0;"> <table style="width: 100%; border-collapse: collapse;"> <tr> <td style="text-align: center;">♥✓</td> <td style="text-align: center;">MAINT</td> <td style="text-align: center;">7:49</td> <td style="text-align: center;">🔊</td> <td style="text-align: center;">📶</td> <td style="text-align: center;">🔋</td> </tr> <tr> <td style="font-size: small;">CH4</td> <td style="font-size: small;">%LEL</td> <td style="font-size: small;">H2S</td> <td style="font-size: small;">ppm</td> <td colspan="2"></td> </tr> <tr> <td style="text-align: center;">47</td> <td></td> <td></td> <td style="text-align: center;">20.5</td> <td colspan="2"></td> </tr> <tr> <td colspan="6" style="text-align: center;">AUTO CAL</td> </tr> </table> </div> <ol style="list-style-type: none"> 4. Close the regulator. 5. Unscrew the regulator. 6. Remove the calibration cup. 7. Press and release POWER MODE to enter Measuring Mode. 	♥✓	MAINT	60	🔊	📶	🔋	CH4	%LEL	CO	H2S	ppm	ppm	30				2.0		AUTO CAL			APPLY GAS			♥✓	MAINT	7:49	🔊	📶	🔋	CH4	%LEL	CO	ppm	H2S	ppm	F	P	P		F	P	O2	%					P						RESULT						♥✓	MAINT	7:49	🔊	📶	🔋	CH4	%LEL	CO	ppm	H2S	ppm	30		47		12.0		O2	%					11.9						BUMP TEST						♥✓	MAINT	7:49	🔊	📶	🔋	CH4	%LEL	H2S	ppm			47			20.5			AUTO CAL						<ol style="list-style-type: none"> 1. A calibration immediately and automatically starts. Continue to apply the calibration gas. 2. The calibration time is the difference between the GAS TIME and the CAL TIME values defined in the BUMP SET\SETTINGS item in User Mode. <div data-bbox="904 653 1213 825" style="border: 1px solid black; padding: 5px; margin: 10px 0;"> <table style="width: 100%; border-collapse: collapse;"> <tr> <td style="text-align: center;">♥✓</td> <td style="text-align: center;">MAINT</td> <td style="text-align: center;">60</td> <td style="text-align: center;">🔊</td> <td style="text-align: center;">📶</td> <td style="text-align: center;">🔋</td> </tr> <tr> <td style="font-size: small;">CH4</td> <td style="font-size: small;">%LEL</td> <td style="font-size: small;">H2S</td> <td style="font-size: small;">ppm</td> <td colspan="2"></td> </tr> <tr> <td style="text-align: center;">30</td> <td></td> <td></td> <td style="text-align: center;">2.0</td> <td colspan="2"></td> </tr> <tr> <td colspan="3" style="text-align: center;">AUTO CAL</td> <td colspan="3" style="text-align: center;">APPLY GAS</td> </tr> </table> </div> <ol style="list-style-type: none"> 3. The instrument shows which channels passed or failed the bump test/calibration. Use AIR to scroll between the results and the readings. <div data-bbox="904 947 1213 1119" style="border: 1px solid black; padding: 5px; margin: 10px 0;"> <table style="width: 100%; border-collapse: collapse;"> <tr> <td style="text-align: center;">♥✓</td> <td style="text-align: center;">MAINT</td> <td style="text-align: center;">7:49</td> <td style="text-align: center;">🔊</td> <td style="text-align: center;">📶</td> <td style="text-align: center;">🔋</td> </tr> <tr> <td style="font-size: small;">CH4</td> <td style="font-size: small;">%LEL</td> <td style="font-size: small;">CO</td> <td style="font-size: small;">ppm</td> <td style="font-size: small;">H2S</td> <td style="font-size: small;">ppm</td> </tr> <tr> <td style="text-align: center;">F</td> <td style="text-align: center;">P</td> <td style="text-align: center;">P</td> <td></td> <td style="text-align: center;">F</td> <td style="text-align: center;">P</td> </tr> <tr> <td style="font-size: small;">O2</td> <td style="font-size: small;">%</td> <td colspan="4"></td> </tr> <tr> <td style="text-align: center;">P</td> <td></td> <td colspan="4"></td> </tr> <tr> <td colspan="6" style="text-align: center;">RESULT</td> </tr> </table> </div> <div style="text-align: center; margin: 5px 0;">  </div> <div data-bbox="904 1182 1213 1354" style="border: 1px solid black; padding: 5px; margin: 10px 0;"> <table style="width: 100%; border-collapse: collapse;"> <tr> <td style="text-align: center;">♥✓</td> <td style="text-align: center;">MAINT</td> <td style="text-align: center;">7:49</td> <td style="text-align: center;">🔊</td> <td style="text-align: center;">📶</td> <td style="text-align: center;">🔋</td> </tr> <tr> <td style="font-size: small;">CH4</td> <td style="font-size: small;">%LEL</td> <td style="font-size: small;">CO</td> <td style="font-size: small;">ppm</td> <td style="font-size: small;">H2S</td> <td style="font-size: small;">ppm</td> </tr> <tr> <td style="text-align: center;">30</td> <td></td> <td style="text-align: center;">47</td> <td></td> <td style="text-align: center;">12.0</td> <td></td> </tr> <tr> <td style="font-size: small;">O2</td> <td style="font-size: small;">%</td> <td colspan="4"></td> </tr> <tr> <td style="text-align: center;">11.9</td> <td></td> <td colspan="4"></td> </tr> <tr> <td colspan="6" style="text-align: center;">BUMP TEST</td> </tr> </table> </div> <div style="text-align: center; margin: 5px 0;">  </div> <div data-bbox="904 1421 1213 1593" style="border: 1px solid black; padding: 5px; margin: 10px 0;"> <table style="width: 100%; border-collapse: collapse;"> <tr> <td style="text-align: center;">♥✓</td> <td style="text-align: center;">MAINT</td> <td style="text-align: center;">7:49</td> <td style="text-align: center;">🔊</td> <td style="text-align: center;">📶</td> <td style="text-align: center;">🔋</td> </tr> <tr> <td style="font-size: small;">CH4</td> <td style="font-size: small;">%LEL</td> <td style="font-size: small;">H2S</td> <td style="font-size: small;">ppm</td> <td colspan="2"></td> </tr> <tr> <td style="text-align: center;">47</td> <td></td> <td></td> <td style="text-align: center;">20.5</td> <td colspan="2"></td> </tr> <tr> <td colspan="6" style="text-align: center;">AUTO CAL</td> </tr> </table> </div> <ol style="list-style-type: none"> 4. Close the regulator. 5. Unscrew the regulator. 6. Remove the calibration cup. 7. Press and release POWER MODE to return to the START item in the BUMP menu. 8. Press and release POWER MODE to enter Measuring Mode. 	♥✓	MAINT	60	🔊	📶	🔋	CH4	%LEL	H2S	ppm			30			2.0			AUTO CAL			APPLY GAS			♥✓	MAINT	7:49	🔊	📶	🔋	CH4	%LEL	CO	ppm	H2S	ppm	F	P	P		F	P	O2	%					P						RESULT						♥✓	MAINT	7:49	🔊	📶	🔋	CH4	%LEL	CO	ppm	H2S	ppm	30		47		12.0		O2	%					11.9						BUMP TEST						♥✓	MAINT	7:49	🔊	📶	🔋	CH4	%LEL	H2S	ppm			47			20.5			AUTO CAL					
♥✓	MAINT	60	🔊	📶	🔋																																																																																																																																																																																																																																												
CH4	%LEL	CO	H2S	ppm	ppm																																																																																																																																																																																																																																												
30				2.0																																																																																																																																																																																																																																													
AUTO CAL			APPLY GAS																																																																																																																																																																																																																																														
♥✓	MAINT	7:49	🔊	📶	🔋																																																																																																																																																																																																																																												
CH4	%LEL	CO	ppm	H2S	ppm																																																																																																																																																																																																																																												
F	P	P		F	P																																																																																																																																																																																																																																												
O2	%																																																																																																																																																																																																																																																
P																																																																																																																																																																																																																																																	
RESULT																																																																																																																																																																																																																																																	
♥✓	MAINT	7:49	🔊	📶	🔋																																																																																																																																																																																																																																												
CH4	%LEL	CO	ppm	H2S	ppm																																																																																																																																																																																																																																												
30		47		12.0																																																																																																																																																																																																																																													
O2	%																																																																																																																																																																																																																																																
11.9																																																																																																																																																																																																																																																	
BUMP TEST																																																																																																																																																																																																																																																	
♥✓	MAINT	7:49	🔊	📶	🔋																																																																																																																																																																																																																																												
CH4	%LEL	H2S	ppm																																																																																																																																																																																																																																														
47			20.5																																																																																																																																																																																																																																														
AUTO CAL																																																																																																																																																																																																																																																	
♥✓	MAINT	60	🔊	📶	🔋																																																																																																																																																																																																																																												
CH4	%LEL	H2S	ppm																																																																																																																																																																																																																																														
30			2.0																																																																																																																																																																																																																																														
AUTO CAL			APPLY GAS																																																																																																																																																																																																																																														
♥✓	MAINT	7:49	🔊	📶	🔋																																																																																																																																																																																																																																												
CH4	%LEL	CO	ppm	H2S	ppm																																																																																																																																																																																																																																												
F	P	P		F	P																																																																																																																																																																																																																																												
O2	%																																																																																																																																																																																																																																																
P																																																																																																																																																																																																																																																	
RESULT																																																																																																																																																																																																																																																	
♥✓	MAINT	7:49	🔊	📶	🔋																																																																																																																																																																																																																																												
CH4	%LEL	CO	ppm	H2S	ppm																																																																																																																																																																																																																																												
30		47		12.0																																																																																																																																																																																																																																													
O2	%																																																																																																																																																																																																																																																
11.9																																																																																																																																																																																																																																																	
BUMP TEST																																																																																																																																																																																																																																																	
♥✓	MAINT	7:49	🔊	📶	🔋																																																																																																																																																																																																																																												
CH4	%LEL	H2S	ppm																																																																																																																																																																																																																																														
47			20.5																																																																																																																																																																																																																																														
AUTO CAL																																																																																																																																																																																																																																																	

Performing a Calibration (GAS CAL)

Calibration Notes

- To fully calibrate the standard 4 (combustible gas, O₂, CO, H₂S) and super toxic sensors, you must do a fresh air adjustment (**AIR CAL**) and a span adjustment (**AUTO CAL**).
- To fully calibrate the IR CO₂ sensor, you must do either a) a fresh air adjustment (**AIR CAL**) and a span adjustment (**AUTO CAL**) or b) a zero adjustment (**CO2 ZERO CAL**) and a span adjustment (**AUTO CAL**).
- Bump test the instrument before each day's use with a known concentration of each target gas. A bump test can be done in User Mode's **BUMP TEST** item or by applying gas in Measuring Mode. The instrument does not need to be calibrated unless it does not pass the User Mode bump test or does not respond appropriately, as defined by the user, in Measuring Mode.
- The hydrogen response for the H₂-compensated CO sensor only needs to be set when the sensor is replaced.

Performing a Fresh Air Adjustment (AIR CAL)

1. Find a fresh air environment, an environment of normal oxygen content (20.9%) that is free of toxic and combustible gases.
2. While in User Mode, use AIR to place the cursor next to **GAS CAL**.



3. Press and release POWER MODE. The Gas Cal menu appears.
4. Use AIR to place the cursor next to **AIR CAL**.

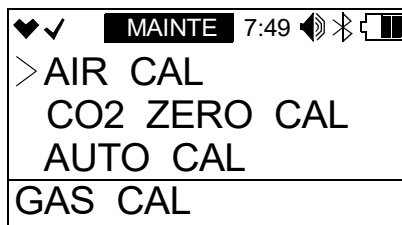

5. Press and release POWER MODE. The example below shows the standard 4 sensors (combustible gas, O₂, CO, H₂S).

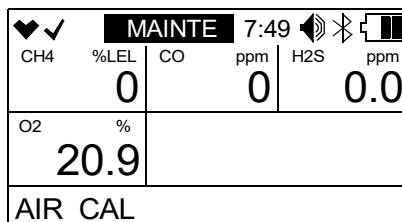

6. Make sure the GX-3R Pro has been turned on for at least 45 seconds before continuing.

7. Press and hold AIR until the screen prompts you to release it.

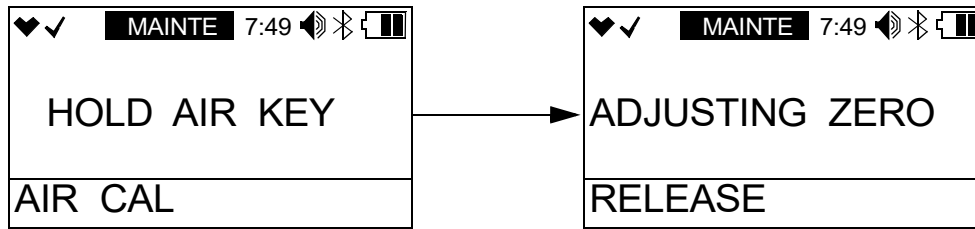

8. If the fresh air adjustment passes, the instrument returns to the Gas Cal menu.
9. If the fresh air adjustment fails, “FAIL AIR” displays. Press and release POWER MODE to acknowledge the failure. See “Troubleshooting” on page 99.

Performing a Zero Adjustment on the CO₂ Sensor (CO₂ ZERO CAL)

Performing a zero adjustment on the CO₂ sensor sets the sensor’s zero to a known concentration of CO₂ (0 ppm or 0%).

Preparing for a CO₂ ZERO CAL

To set the zero reading on the CO₂ sensor, you will need:

- 100% nitrogen (N₂) cylinder
 - 0.25 LPM fixed flow regulator
 - Non-absorbent tubing
 - Calibration cup
1. Confirm that the regulator knob is turned all the way clockwise. Screw the 0.25 LPM fixed flow regulator onto the calibration cylinder.
 2. Install the calibration cup onto the GX-3R Pro. Use the label and imprinting to make sure that the calibration cup gets installed in the correct orientation relative to the GX-3R Pro. Be sure the calibration cup is pushed on all the way.

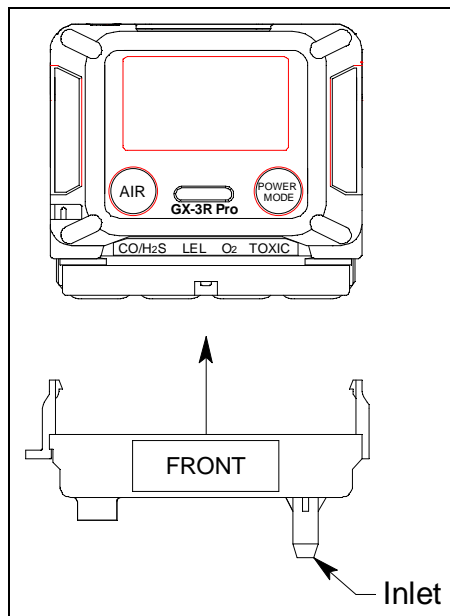
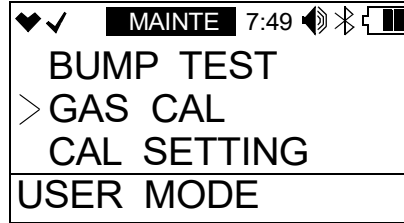

Figure 9: Calibration Cup Installation

3. Use the tubing to connect the regulator to the inlet of the calibration cup.

Performing a CO2 ZERO CAL

1. While in User Mode, use AIR to place the cursor next to **GAS CAL**.



2. Press and release POWER MODE. The Gas Cal menu appears.
3. Use AIR to place the cursor next to **CO2 ZERO CAL**.

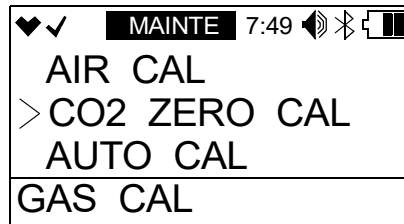

4. Make sure the GX-3R Pro has been turned on for at least 45 seconds before continuing.
5. Press and release POWER MODE.
6. The CO₂ gas reading flashes and the bottom of the screen indicates “CO2 ZERO CAL” and “APPLY GAS”.

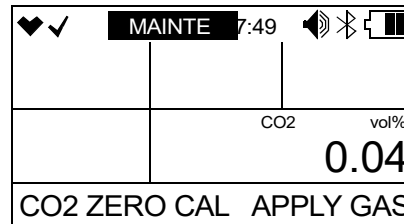

NOTE: To back out of the gas application screen without performing the bump test, press and release AIR and POWER MODE together.

7. Turn the regulator knob counterclockwise to open the regulator.
8. Allow the gas to flow for 1 minute.
9. Press and release POWER MODE.
10. Turn the regulator knob clockwise to close the regulator.
11. If the zero adjustment passed the screen says “PASS” and the instrument returns to the Gas Cal menu.

- 12 . If the zero adjustment failed:
- “FAIL” replaces the gas reading.

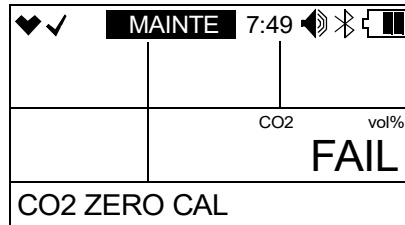

- The LEDs flash and the buzzer sounds a double pulsing tone.
 - Press and release POWER MODE to clear the failure. The instrument returns to the **GAS CAL** menu.
 - See “Troubleshooting” on page 99.
- 13 . Unscrew the regulator from the calibration cylinder.
- 14 . Remove the calibration cup from the GX-3R Pro.
- 15 . Store the calibration kit in a safe and convenient place.
- 16 . Use AIR to place the cursor next to **ESCAPE**.
- 17 . Press and release POWER MODE. The instrument returns to User Mode.

Performing a Span Adjustment in AUTO CAL

Preparing for a Span Adjustment

To perform a span adjustment on the GX-3R Pro, you will need:

- Known concentrations of the gases being detected.

Table 14: Calibration Concentration Limits

Channel	Min. Cal. Concentration	Max. Cal. Concentration
Combustible Gas	5% LEL	75% LEL
Oxygen	0.0%	18.0%
Hydrogen Sulfide	1.0 ppm	200.0 ppm
Carbon Monoxide	15 ppm	2,000 ppm
Hydrogen (for H ₂ -compensated CO sensor); only needs to be done when sensor is replaced	25 ppm	2,000 ppm
Ammonia	8 ppm	400 ppm
Carbon Dioxide (0 - 10,000 ppm)	3,000 ppm	9,000 ppm
Carbon Dioxide (0 - 10.00% vol)	1.00% vol	4.00% vol
Hydrogen Cyanide	0.9 ppm	30.0 ppm
Nitrogen Dioxide	0.50 ppm	20.00 ppm
Phosphine	0.05 ppm	20.00 ppm
Sulfur Dioxide	0.50 ppm	100.00 ppm

- 0.25 LPM fixed flow regulator
 - Non-absorbent tubing
 - Calibration cup
1. Confirm that the GX-3R Pro's calibration gas values match the concentrations listed on the calibration gas cylinder(s) as described on pg.71.
 2. Confirm that your cylinder selections are appropriate as described on pg.73.
 3. Install the calibration cup onto the GX-3R Pro. Use the label and imprinting to make sure that the calibration cup gets installed in the correct orientation relative to the GX-3R Pro. Be sure the calibration cup is pushed on all the way.

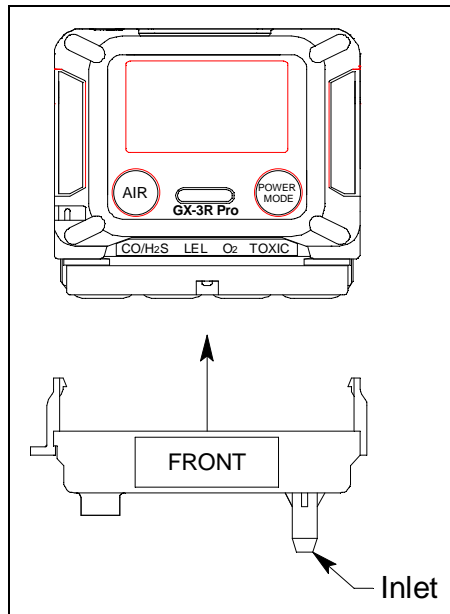

Figure 10: Calibration Cup Installation

4. Use the tubing to connect the regulator to the inlet of the calibration cup.

Performing a Span Adjustment

1. While in User Mode, use AIR to place the cursor next to **GAS CAL**.



2. Press and release POWER MODE. The Gas Cal menu appears.
3. Use AIR to place the cursor next to **AUTO CAL**.

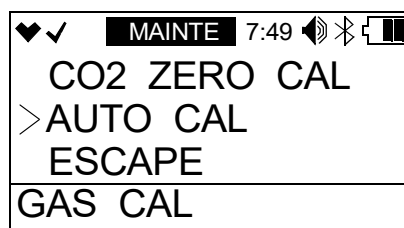

- Press and release POWER MODE. The display shows the gases assigned to Cylinder A and the assigned calibration values (see pg.71 if the calibration values do not match the calibration gas cylinder's concentrations).

♥✓		MAINT		7:49		🔊		📶		🔋	
CH4	%LEL	CO	ppm	H2S	ppm						
	50		50		25.0						
O2	%										
	12.0										
AUTO CAL		CYLINDER A									

- If necessary, use AIR to scroll to the Auto Cal screen for the gas(es) you want to calibrate. As shipped from the factory, the standard 4 gases (combustible gas, O₂, CO, and H₂S) are assigned to Cylinder A. If a H₂-compensated CO sensor is installed, H₂ is assigned to Cylinder D but there is no reason to bump test the H₂ response. Toxic sensors are assigned to Cylinder D or Cylinder E.
- Make sure the GX-3R Pro has been turned on for at least 45 seconds before continuing.
- Press and release POWER MODE.
- The gas readings flash and the bottom of the screen indicates “AUTO CAL” and “APPLY GAS”.

♥✓		MAINT		30		🔊		📶		🔋	
CH4	%LEL	CO	ppm	H2S	ppm						
	0		0		0.0						
O2	%										
	20.9										
AUTO CAL		APPLY GAS									

NOTE: To back out of the gas application screen without performing the bump test, press and release AIR and POWER MODE together.

- For toxic gas cylinders (like cylinders containing H₂S), it is important to vent the regulator while installing it onto the cylinder. Venting the regulator during installation helps prevent air from getting into the cylinder and degrading the gas. Open the regulator by turning the knob counterclockwise and install it onto the cylinder.
- Allow the gas to flow for 1 minute for all gases except NH₃. Allow NH₃ gas to flow for 2 minutes.
- Press and release POWER MODE.

12 . Follow the flow chart to determine the calibration outcome.

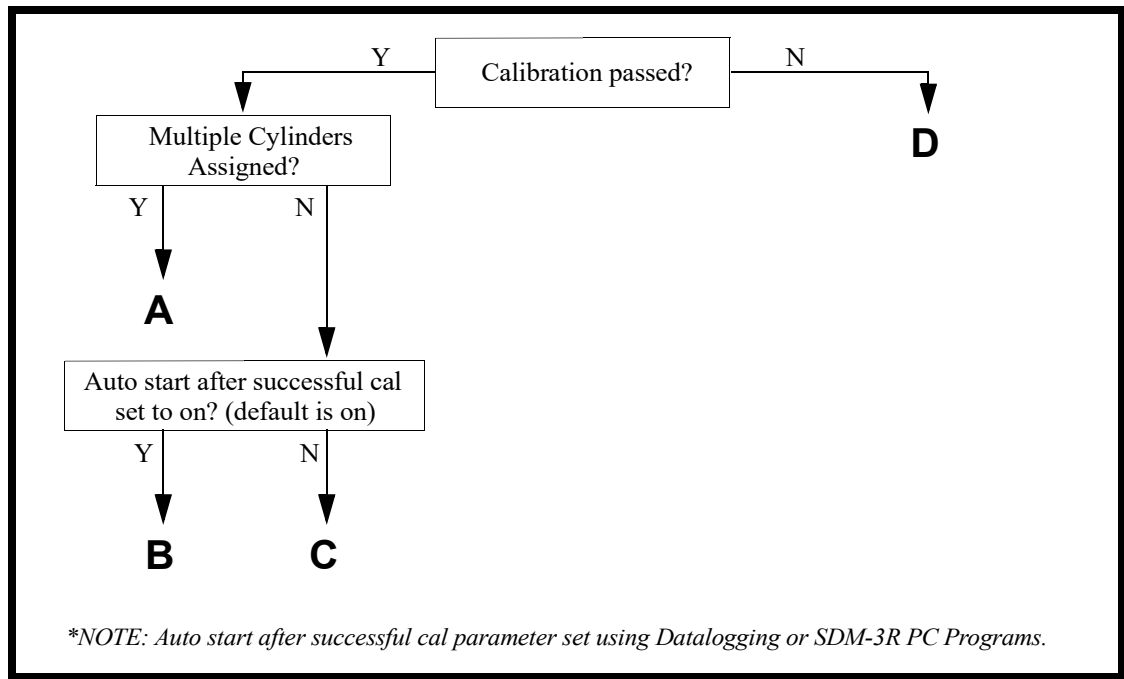
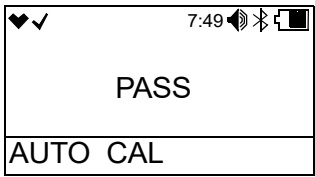
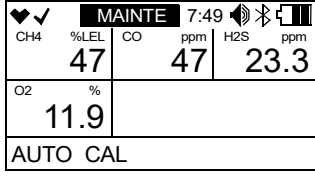
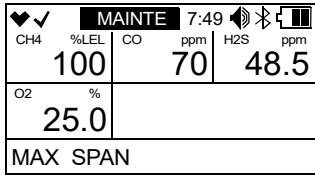
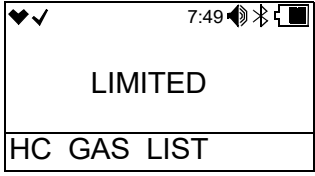
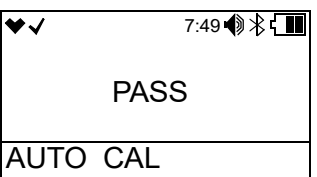
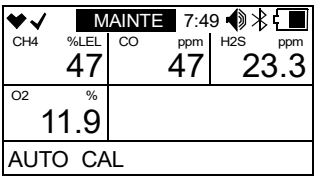
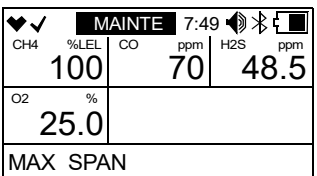



Figure 11: Calibration Flow Chart

Option A from Flow Chart	Option B from Flow Chart
<ul style="list-style-type: none"> • Calibration passed • Multiple cylinders assigned 	<ul style="list-style-type: none"> • Calibration passed • One cylinder assigned • Auto Start After Successful Cal set to ON (factory setting)
<p>1. The instrument indicates that all channels passed the calibration.</p>  <p>2. The instrument shows the current gas readings.</p>  <p>3. If DISP MAX SPAN is set to ON (default is OFF, see pg.166), the response reading's maximum adjustment displays. A maximum span of 100% LEL on the combustible channel indicates that the reading could have been adjusted up to 100% LEL. If the maximum span value is close to the calibration gas value, the sensor should be replaced soon.</p> <p>The maximum adjustment is either twice the calibration value or full scale, whichever is lower. The maximum adjustment for the oxygen channel is 25.0% volume.</p>  <p>4. If the combustible gas sensor is nearing the end of its useful life, the reading conversions that can be made in Display Mode's HC GAS LIST item become limited. Press and release POWER MODE. See pg.40 for the limited conversion list. Replace the combustible sensor as soon as possible.</p>  <p>5. Close the regulator. 6. The instrument continues to the AUTO CAL CYL X screen. 7. Unscrew the regulator from the first cylinder and screw it into the next cylinder. 8. Press and release POWER MODE to start the next cylinder's calibration. 9. Repeat Step 9 through Step 12. 10. After the last cylinder is calibrated, the instrument continues to the START MEASURE item in the AUTO CAL menu. 11. Remove the calibration cup. 12. Press and release POWER MODE to enter Measuring Mode.</p>	<p>1. The instrument indicates that all channels passed the calibration.</p>  <p>2. The instrument shows the current gas readings.</p>  <p>3. If DISP MAX SPAN is set to ON (default is OFF, see pg.166), the response reading's maximum adjustment displays. A maximum span of 100% LEL on the combustible channel indicates that the reading could have been adjusted up to 100% LEL. If the maximum span value is close to the calibration gas value, the sensor should be replaced soon.</p> <p>The maximum adjustment is either twice the calibration value or full scale, whichever is lower. The maximum adjustment for the oxygen channel is 25.0% volume.</p>  <p>4. If the combustible gas sensor is nearing the end of its useful life, the reading conversions that can be made in Display Mode's HC GAS LIST item become limited. Press and release POWER MODE. See pg.40 for the limited conversion list. Replace the combustible sensor as soon as possible.</p>  <p>5. Close the regulator. 6. Unscrew the regulator. 7. Remove the calibration cup. 8. The instrument automatically begins its warmup sequence and enters Measuring Mode.</p>

Option C from Flow Chart	Option D from Flow Chart																																																																																																												
<ul style="list-style-type: none"> • Calibration passed • One cylinder assigned • Auto Start After Successful Cal set to OFF (factory setting is ON) 	<ul style="list-style-type: none"> • Calibration failed 																																																																																																												
<ol style="list-style-type: none"> The instrument indicates that all channels passed the calibration. <div data-bbox="290 449 599 619" style="border: 1px solid black; padding: 5px; margin: 10px 0;"> <p style="text-align: center;">PASS</p> <p style="text-align: center;">AUTO CAL</p> </div> The instrument shows the current gas readings. <div data-bbox="290 659 599 829" style="border: 1px solid black; padding: 5px; margin: 10px 0;"> <table border="1" style="width: 100%; border-collapse: collapse;"> <tr> <td colspan="6" style="text-align: center;">MAINT 7:49</td> </tr> <tr> <td>CH4</td> <td>%LEL</td> <td>CO</td> <td>ppm</td> <td>H2S</td> <td>ppm</td> </tr> <tr> <td></td> <td>47</td> <td>47</td> <td></td> <td>23.3</td> <td></td> </tr> <tr> <td>O2</td> <td>%</td> <td colspan="4"></td> </tr> <tr> <td></td> <td>11.9</td> <td colspan="4"></td> </tr> <tr> <td colspan="6" style="text-align: center;">AUTO CAL</td> </tr> </table> </div> If DISP MAX SPAN is set to ON (default is OFF, see pg.166), the response reading's maximum adjustment displays. A maximum span of 100% LEL on the combustible channel indicates that the reading could have been adjusted up to 100% LEL. If the maximum span value is close to the calibration gas value, the sensor should be replaced soon. <p>The maximum adjustment is either twice the calibration value or full scale, whichever is lower. The maximum adjustment for the oxygen channel is 25.0% volume.</p> <div data-bbox="290 1108 599 1278" style="border: 1px solid black; padding: 5px; margin: 10px 0;"> <table border="1" style="width: 100%; border-collapse: collapse;"> <tr> <td colspan="6" style="text-align: center;">MAINT 7:49</td> </tr> <tr> <td>CH4</td> <td>%LEL</td> <td>CO</td> <td>ppm</td> <td>H2S</td> <td>ppm</td> </tr> <tr> <td></td> <td>100</td> <td>70</td> <td></td> <td>48.5</td> <td></td> </tr> <tr> <td>O2</td> <td>%</td> <td colspan="4"></td> </tr> <tr> <td></td> <td>25.0</td> <td colspan="4"></td> </tr> <tr> <td colspan="6" style="text-align: center;">MAX SPAN</td> </tr> </table> </div> If the combustible gas sensor is nearing the end of its useful life, the reading conversions that can be made in Display Mode's HC GAS LIST item become limited. Press and release POWER MODE. See pg.40 for the limited conversion list. Replace the combustible sensor as soon as possible. <div data-bbox="290 1428 599 1598" style="border: 1px solid black; padding: 5px; margin: 10px 0;"> <p style="text-align: center;">LIMITED</p> <p style="text-align: center;">HC GAS LIST</p> </div> <ol style="list-style-type: none"> Close the regulator. Unscrew the regulator. Remove the calibration cup. The instrument continues to the START MEASURE item in the AUTO CAL menu. Press and release POWER MODE to enter Measuring Mode. 	MAINT 7:49						CH4	%LEL	CO	ppm	H2S	ppm		47	47		23.3		O2	%						11.9					AUTO CAL						MAINT 7:49						CH4	%LEL	CO	ppm	H2S	ppm		100	70		48.5		O2	%						25.0					MAX SPAN						<ol style="list-style-type: none"> The instrument indicates which channels failed the calibration. <div data-bbox="1015 445 1323 615" style="border: 1px solid black; padding: 5px; margin: 10px 0;"> <table border="1" style="width: 100%; border-collapse: collapse;"> <tr> <td colspan="6" style="text-align: center;">MAINT 7:49</td> </tr> <tr> <td>CH4</td> <td>%LEL</td> <td>CO</td> <td>ppm</td> <td>H2S</td> <td>ppm</td> </tr> <tr> <td></td> <td>FAIL</td> <td>47</td> <td></td> <td>23.3</td> <td></td> </tr> <tr> <td>O2</td> <td>%</td> <td colspan="4"></td> </tr> <tr> <td></td> <td>11.9</td> <td colspan="4"></td> </tr> <tr> <td colspan="6" style="text-align: center;">AUTO CAL</td> </tr> </table> </div> Close the regulator. Unscrew the regulator. Remove the calibration cup. Press and release POWER MODE to return to the AUTO CAL CYL X screen in the AUTO CAL menu. See "Troubleshooting" on page 99. 	MAINT 7:49						CH4	%LEL	CO	ppm	H2S	ppm		FAIL	47		23.3		O2	%						11.9					AUTO CAL					
MAINT 7:49																																																																																																													
CH4	%LEL	CO	ppm	H2S	ppm																																																																																																								
	47	47		23.3																																																																																																									
O2	%																																																																																																												
	11.9																																																																																																												
AUTO CAL																																																																																																													
MAINT 7:49																																																																																																													
CH4	%LEL	CO	ppm	H2S	ppm																																																																																																								
	100	70		48.5																																																																																																									
O2	%																																																																																																												
	25.0																																																																																																												
MAX SPAN																																																																																																													
MAINT 7:49																																																																																																													
CH4	%LEL	CO	ppm	H2S	ppm																																																																																																								
	FAIL	47		23.3																																																																																																									
O2	%																																																																																																												
	11.9																																																																																																												
AUTO CAL																																																																																																													

Setting the Calibration Values in SETTING CAL--P

1. While in User Mode, use AIR to place the cursor next to **GAS CAL**.

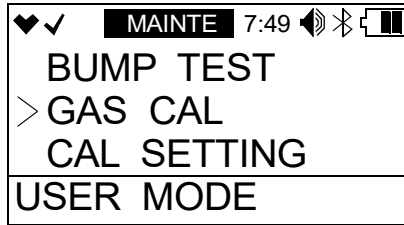

2. Press and release POWER MODE. The Gas Cal menu appears.
3. Use AIR to place the cursor next to **AUTO CAL**.

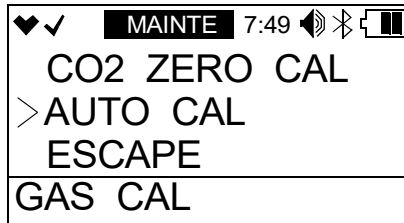

4. Press and release POWER MODE. The Auto Cal screen for gases assigned to Cylinder A displays.
5. Use AIR to scroll to **SETTING CAL--P**.



6. Press and release POWER MODE. The combustible gas channel displays.

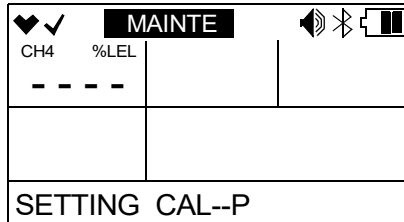

7. Use AIR to scroll to the channel whose calibration gas value you want to change.



8. Press and release POWER MODE. The calibration gas value begins to flash. In the example below, the combustible gas channel is selected.
9. Use AIR to adjust the calibration gas value. The calibration gas value in the instrument must match the value listed on the calibration gas cylinder you are using for that channel. Limits on the calibration gas value are shown in the table below.

Table 15: Calibration Concentration Limits

Channel	Min. Cal. Concentration	Max. Cal. Concentration
Combustible Gas	5% LEL	75% LEL
Oxygen	0.0%	18.0%
Hydrogen Sulfide	1.0 ppm	200.0 ppm
Carbon Monoxide	15 ppm	2,000 ppm
Hydrogen (for H ₂ -compensated CO sensor); only needs to be done when sensor is replaced	25 ppm	2,000 ppm
Ammonia	8 ppm	400 ppm

Table 15: Calibration Concentration Limits

Channel	Min. Cal. Concentration	Max. Cal. Concentration
Carbon Dioxide (0 - 10,000 ppm)	3,000 ppm	9,000 ppm
Carbon Dioxide (0 - 10.00% vol)	1.00% vol	4.00% vol
Hydrogen Cyanide	0.9 ppm	30.0 ppm
Nitrogen Dioxide	0.50 ppm	20.00 ppm
Phosphine	0.05 ppm	20.00 ppm
Sulfur Dioxide	0.50 ppm	100.00 ppm

- 10 . Press and release POWER MODE to save the change. The calibration gas value stops flashing and the unit returns to the channel selection screen.
- 11 . Repeat Step 7 through Step 10 for any other channels that need to be changed.
- 12 . Use AIR to place the cursor next to **ESCAPE**.
- 13 . Press and release POWER MODE. The instrument returns to the **SETTING CAL--P** menu item in the Auto Cal Menu.
- 14 . Use AIR to place the cursor next to **ESCAPE**.
- 15 . Press and release POWER MODE. The instrument returns to the **GAS CAL** menu.
- 16 . See “Exiting the GAS CAL Menu” on page 75 to return to User Mode.

Making Cylinder Selections in CYL SETTING

The **CYL SETTING** menu item allows you to group gases together for calibration. As shipped from the factory, the standard 4 gases (combustible gas, O₂, H₂S, CO) are assigned to Cylinder A which means all 4 gases are calibrated at once. As shipped from the factory, the hydrogen-compensated CO and toxic gases are assigned to Cylinder D or Cylinder E. There are 5 cylinder assignments available: A, B, C, D, and E. To calibrate each gas separately, assign each gas to a different cylinder (ie. Cylinder A: combustible gas, Cylinder B: O₂, Cylinder C: H₂S, Cylinder D: CO, Cylinder E: CO₂).

- 1 . While in User Mode, use AIR to place the cursor next to **GAS CAL**.



- 2 . Press and release POWER MODE. The Gas Cal menu appears.
- 3 . Use AIR to place the cursor next to **AUTO CAL**.

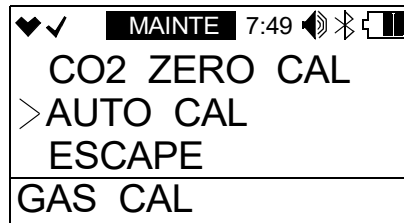

- 4 . Press and release POWER MODE. The Auto Cal screen for gases assigned to Cylinder

A displays.

5. Use AIR to scroll to **CYL SETTING**.

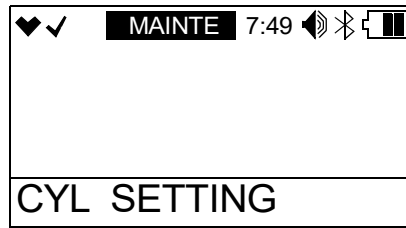

6. Press and release POWER MODE. The combustible gas channel displays.

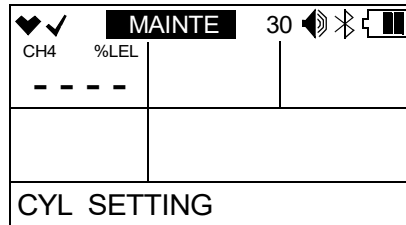

7. Use AIR to scroll to the channel whose cylinder assignment you want to change.

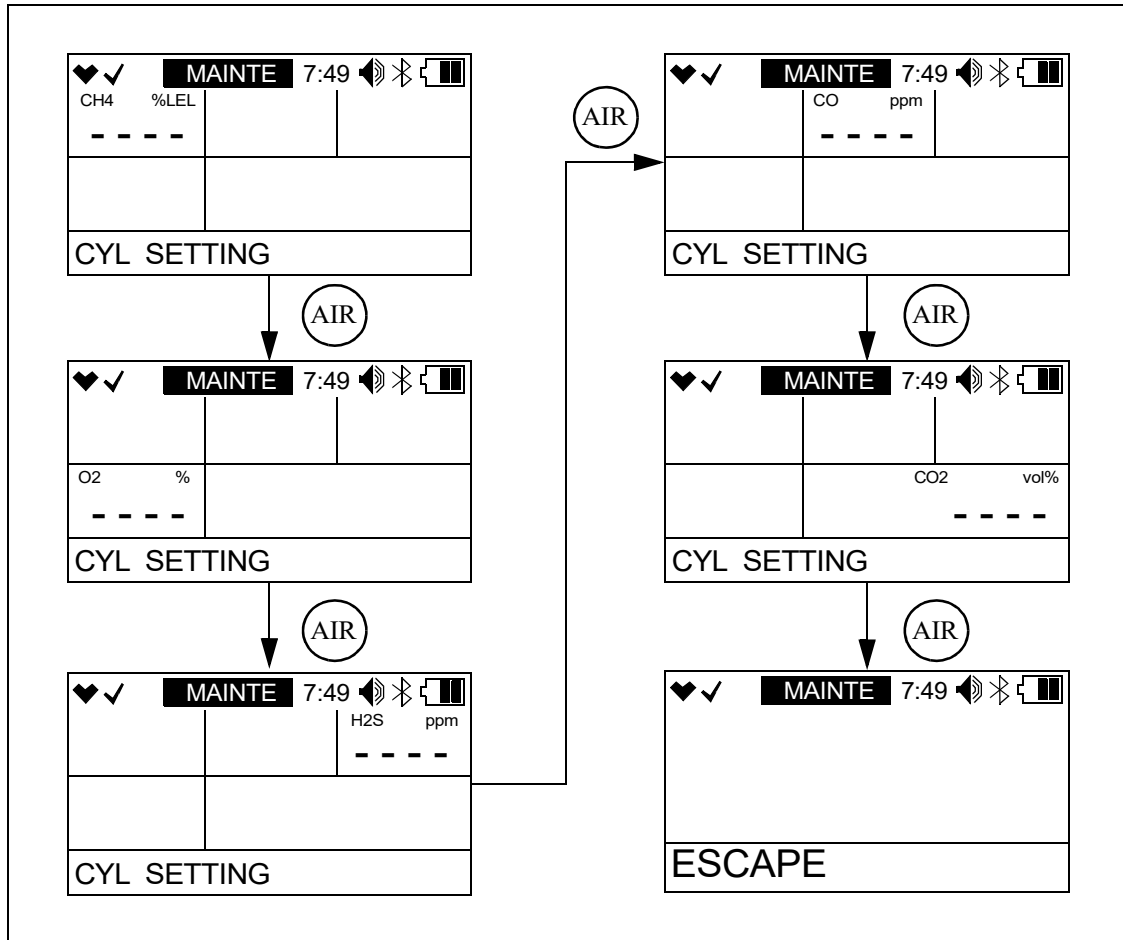

- Press and release POWER MODE. The current setting flashes. In the example below, the combustible gas channel is selected.

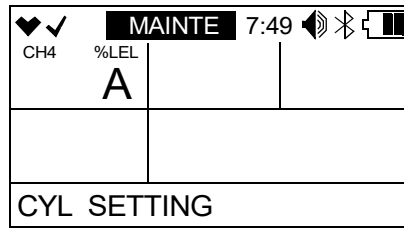

- Use AIR to change the cylinder assignment. The choices are A, B, C, D, and E.
- Press and release POWER MODE to save the change. The cylinder assignment stops flashing and the unit returns to the channel selection screen.
- Repeat Step 7 through Step 10 for any other channels that need to be changed.
- Use AIR to place the cursor next to **ESCAPE**.
- Press and release POWER MODE. The instrument will return to the **CYL SETTING** menu item in the Auto Cal Menu.
- Use AIR to place the cursor next to **ESCAPE**.
- Press and release POWER MODE to return to the **GAS CAL** menu.
- See “Exiting the GAS CAL Menu” on page 75 to return to User Mode.

Exiting the GAS CAL Menu

- While in the **GAS CAL** menu, press AIR to scroll to **ESCAPE**.
- Press and release POWER MODE. The instrument returns to the **GAS CAL** menu item in User Mode.
- See “Returning to Measuring Mode (START MEASURE)” on page 98 to enter Measuring Mode.

Setting Calibration Parameters (CAL SETTING)

The **CAL SETTING** menu item has 5 items: **CAL REMINDER**, **CAL INTERVAL**, **CAL EXPIRED**, **CAL CHECK GAS**, and **ESCAPE**.

- While in User Mode, use AIR to place the cursor next to **CAL SETTING**.



- Press and release POWER MODE. The **CAL SETTING** menu appears.

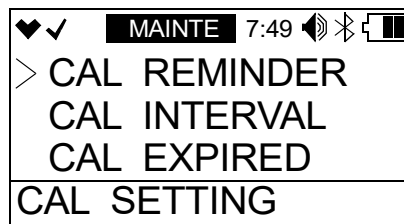

CAL REMINDER

ON (factory setting): The GX-3R Pro gives an indication at start up if it is due for calibration. The type of indication depends on the **CAL EXPIRED** setting (see pg.76).

OFF: The GX-3R Pro does not give an indication at start up if it is due for calibration.

1. While in the **CAL SETTING** menu, use AIR to place the cursor next to **CAL REMINDER**.

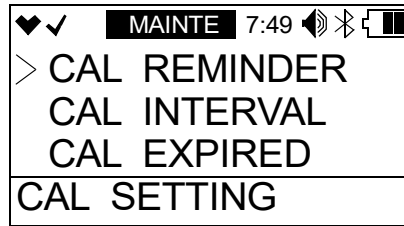

2. Press and release POWER MODE. The current setting flashes.
3. Use AIR to display the desired setting.
4. Press and release POWER MODE to save the setting and return to the **CAL SETTING** menu.
5. See “ESCAPE” on page 77 to return to User Mode.

CAL INTERVAL

This setting defines the amount of time between calibrations. The time can be set in 1 day increments. The minimum setting is 1 day and the maximum setting is 1000 days. The factory setting is 90 days.

1. While in the **CAL SETTING** menu, use AIR to place the cursor next to **CAL INTERVAL**.

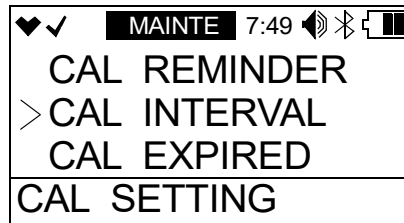

2. Press and release POWER MODE. The current setting flashes.
3. Use AIR to display the desired setting.
4. Press and release POWER MODE to save the setting and return to the **CAL SETTING** menu.
5. See “ESCAPE” on page 77 to return to User Mode.

CAL EXPIRED

This item defines what indication is given during start up when calibration is due and **CAL REMINDER** is set to **ON**.

CONFIRM TO USE (factory setting): The GX-3R Pro gives an indication at start up if calibration is past due. Press and release AIR to continue without calibrating or POWER MODE to perform a calibration.

CANNOT USE: The GX-3R Pro gives an indication at start up if calibration is past due. Press and release POWER MODE to enter User Mode and perform a calibration. Pressing AIR has no effect. A successful calibration must be performed in order to use the instrument.

NO EFFECT: The GX-3R Pro gives an indication at startup if calibration is past due. If desired, press POWER MODE to perform a calibration but it is not necessary to acknowledge the calibration due indication. The warm-up sequence will continue on its own.

1. While in the **CAL SETTING** menu, use AIR to place the cursor next to **CAL EXPIRED**.

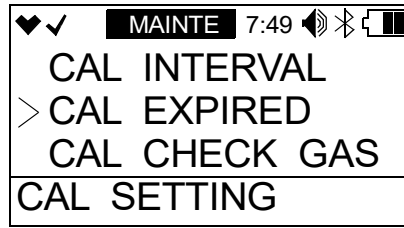

2. Press and release POWER MODE. The current setting flashes.
3. Use AIR to display the desired setting.
4. Press and release POWER MODE to save the setting and return to the **CAL SETTING** menu.
5. See “ESCAPE” on page 77 to return to User Mode.

CAL CHECK GAS

ALL GAS (factory setting): Calibration dates for all gases are used to determine if calibration is due.

4 GAS: Calibration dates for only the standard 4 gases (combustible gas/O₂/H₂S/CO) are used to determine if calibration is due.

1. While in the **CAL SETTING** menu, use AIR to place the cursor next to **CAL CHECK GAS**.



2. Press and release POWER MODE. The current setting flashes.
3. Use AIR to display the desired setting.
4. Press and release POWER MODE to save the setting and return to the **CAL SETTING** menu.
5. See “ESCAPE” on page 77 to return to User Mode.

ESCAPE

1. While in the **CAL SETTING** menu, use AIR to place the cursor next to **ESCAPE**.
2. Press and release POWER MODE. The instrument returns to User Mode.
3. See “Returning to Measuring Mode (START MEASURE)” on page 98 to return to Measuring Mode.

Setting Bump Test Parameters (BUMP SETTING)

The **BUMP SETTING** menu item has 6 items: **BUMP PARAMETERS**, **BUMP REMINDER**, **BUMP INTERVAL**, **BUMP EXPIRED**, **BUMP CHECK GAS**, and **ESCAPE**.

1. While in User Mode, use **AIR** to place the cursor next to **BUMP SETTING**.

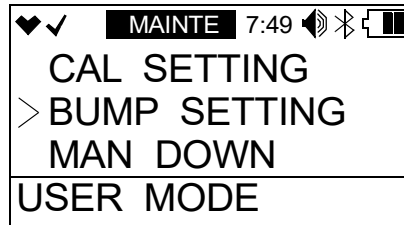

2. Press and release **POWER MODE**. The **BUMP SETTING** menu appears.

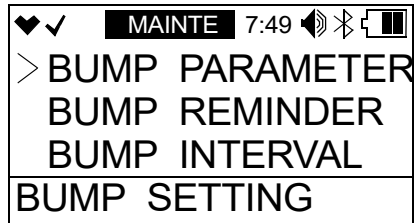

BUMP PARAMETER

The **BUMP PARAMETER** menu item has 5 items: **GAS TIME**, **TOLERANCE**, **CAL TIME**, **AUTO CAL**, and **ESCAPE**.

1. While in the **BUMP SETTING** menu, use **AIR** to place the cursor next to **BUMP PARAMETER**.

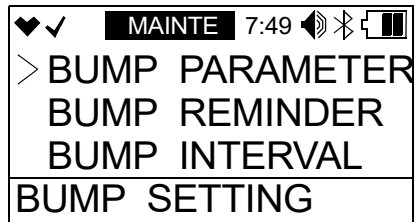

2. Press and release **POWER MODE**. The **BUMP PARAMETER** menu appears.

GAS TIME

The **GAS TIME** is the amount of time that the instrument is exposed to gas during a bump test. The available choices are **30** seconds (factory setting), **45** seconds, **60** seconds, and **90** seconds.

1. While in the **BUMP SETTING\BUMP PARAMETER** menu, use **AIR** to place the cursor next to **GAS TIME**.

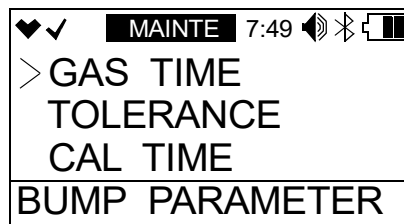

2. Press and release **POWER MODE**. The current setting flashes.
3. Use **AIR** to display the desired setting.

4. Press and release **POWER MODE** to save the setting and return to the **BUMP PARAMETER** menu.
5. See “ESCAPE” on page 80 to return to the **BUMP SETTING** menu.
6. See “ESCAPE” on page 82 to return to User Mode.

TOLERANCE

TOLERANCE is the bump test tolerance value and is represented as a percentage of the calibration gas concentration. It is the percentage that the bump test reading can differ from the actual gas concentration. If the bump test reading differs more, the bump test will fail. The available values are **10%**, **20%**, **30%**, **40%**, and **50%** (factory setting).

1. While in the **BUMP SETTING****BUMP PARAMETER** menu, use **AIR** to place the cursor next to **TOLERANCE**.

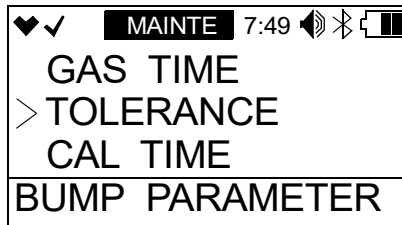

2. Press and release **POWER MODE**. The current setting flashes.
3. Use **AIR** to display the desired setting.
4. Press and release **POWER MODE** to save the setting and return to the **BUMP PARAMETER** menu.
5. See “ESCAPE” on page 80 to return to the **BUMP SETTING** menu.
6. See “ESCAPE” on page 82 to return to User Mode.

CAL TIME

The **CAL TIME** is the total time the instrument is exposed to calibration gas when a bump test fails if **AUTO CAL** is set to **ON**. The bump test time is deducted from the calibration time. For example, if the **CAL TIME** is set to 90 seconds and the **GAS TIME** is set to 30 seconds, if the bump test fails, the GX-3R Pro will only be exposed to gas for an additional 60 seconds. The available values are **90** seconds (factory setting), and **120** seconds.

1. While in the **BUMP SETTING****BUMP PARAMETER** menu, use **AIR** to place the cursor next to **CAL TIME**.



2. Press and release **POWER MODE**. The current setting flashes.
3. Use **AIR** to display the desired setting.
4. Press and release **POWER MODE** to save the setting and return to the **BUMP PARAMETER** menu.
5. See “ESCAPE” on page 80 to return to the **BUMP SETTING** menu.
6. See “ESCAPE” on page 82 to return to User Mode.

AUTO CAL

ON (factory setting): If a bump test fails, the unit automatically begins a calibration.

OFF: If a bump test fails, the unit does not automatically begin a calibration.

1. While in the **BUMP SETTING\BUMP PARAMETER** menu, use AIR to place the cursor next to **AUTO CAL**.



2. Press and release POWER MODE. The current setting flashes.
3. Use AIR to display the desired setting.
4. Press and release POWER MODE to save the setting and return to the **BUMP PARAMETER** menu.
5. See “ESCAPE” on page 80 to return to the **BUMP SETTING** menu.
6. See “ESCAPE” on page 82 to return to User Mode.

ESCAPE

1. While in the **BUMP SETTING\BUMP PARAMETER** menu, use AIR to place the cursor next to **ESCAPE**.



2. Press and release POWER MODE. The instrument returns to the **BUMP PARAMETER** menu.

BUMP REMINDER

ON: The GX-3R Pro gives an indication at start up if it is due for bump testing. The type of indication depends on the **BUMP EXPIRED** setting (see pg.81).

OFF (factory setting): The GX-3R Pro does not give an indication at start up if it is due for bump testing.

1. While in the **BUMP SETTING** menu, use AIR to place the cursor next to **BUMP REMINDER**.

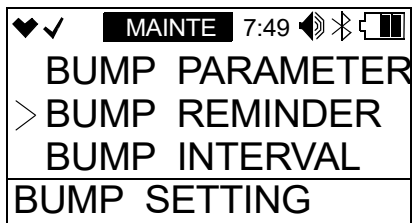

2. Press and release POWER MODE. The current setting flashes.
3. Use AIR to display the desired setting.
4. Press and release POWER MODE to save the setting and return to the **BUMP SETTING** menu.
5. See “ESCAPE” on page 82 to return to User Mode.

BUMP INTERVAL

This setting defines the amount of time between bump tests. The time can be set in 1 day increments. The minimum setting is **0** days and the maximum setting is **30** days. The factory setting is **30** days.

1. While in the **BUMP SETTING** menu, use AIR to place the cursor next to **BUMP INTERVAL**.

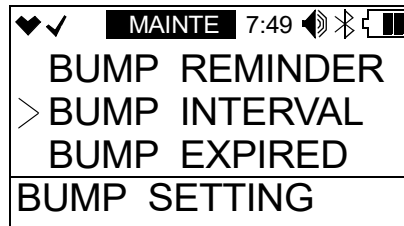

2. Press and release POWER MODE. The current setting flashes.
3. Use AIR to display the desired setting.
4. Press and release POWER MODE to save the setting and return to the **BUMP SETTING** menu.
5. See “ESCAPE” on page 82 to return to User Mode.

BUMP EXPIRED

This item defines what indication is given during start up when a bump test is due and **BUMP REMINDER** is set to **ON**.

CONFIRM TO USE (factory setting): The GX-3R Pro gives an indication at start up if a bump test is past due. Press and release AIR to continue without bump testing or POWER MODE to perform a bump test.

CANNOT USE: The GX-3R Pro gives an indication at start up if a bump test is past due. Press and release POWER MODE to enter User Mode and perform a bump test. Pressing AIR has no effect. A successful bump test must be performed in order to use the instrument.

NO EFFECT: The GX-3R Pro gives an indication at startup if a bump test is past due. If desired, press POWER MODE to perform a bump test but it is not necessary to acknowledge the bump test due indication. The warm-up sequence will continue on its own.

1. While in the **BUMP SETTING** menu, use AIR to place the cursor next to **BUMP EXPIRED**.

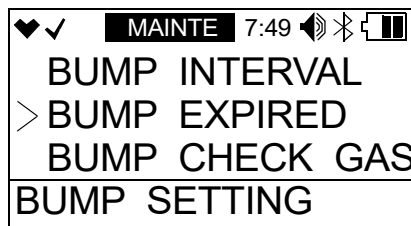

2. Press and release POWER MODE. The current setting flashes.
3. Use AIR to display the desired setting.
4. Press and release POWER MODE to save the setting and return to the **BUMP SETTING** menu.
5. See “ESCAPE” on page 82 to return to User Mode.

BUMP CHECK GAS

ALL GAS (factory setting): Bump test dates for all gases are used to determine if bump test is due.

4 GAS: Bump test dates for only the standard 4 gases (combustible gas/O₂/H₂S/CO) are used to determine if bump test is due.

1. While in the **BUMP SETTING** menu, use AIR to place the cursor next to **BUMP CHECK GAS**.

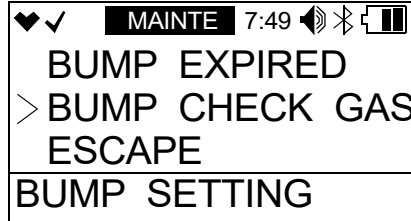

2. Press and release POWER MODE. The current setting flashes.
3. Use AIR to display the desired setting.
4. Press and release POWER MODE to save the setting and return to the **BUMP SETTING** menu.
5. See “ESCAPE” on page 82 to return to User Mode.

ESCAPE

1. While in the **BUMP SETTING** menu, use AIR to place the cursor next to **ESCAPE**.



2. Press and release POWER MODE. The instrument will return to User Mode.
3. See “Returning to Measuring Mode (START MEASURE)” on page 98 to return to Measuring Mode.

Adjusting Man Down and Panic Settings (MAN DOWN)

The **MAN DOWN** menu item has 4 items: **MAN DOWN**, **PANIC**, **MAN DOWN TIME**, and **ESCAPE**.

1. While in User Mode, use AIR to place the cursor next to **MAN DOWN**.

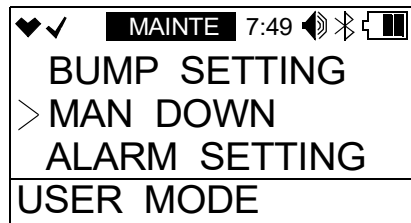

2. Press and release POWER MODE. The **MAN DOWN** menu appears.



Turning Man Down On/Off

ON: The Man Down alarm is triggered if the instrument detects no motion for the period of time defined in **WARNING 1 TIME**, **WARNING 2 TIME**, and **ALARM TIME** below.

OFF (factory setting): The Man Down alarm is not triggered.

1. While in the **MAN DOWN** menu, use AIR to place the cursor next to **MAN DOWN**.



2. Press and release POWER MODE. The current setting flashes.
3. Use AIR to display the desired setting.
4. Press and release POWER MODE to save the setting and return to the **MAN DOWN** menu.
5. See “ESCAPE” on page 85 to return to User Mode.

Turning Panic On/Off

ON: A Panic Alarm can be initiated by firmly tapping the instrument twice in a row.

OFF (factory setting): A Panic Alarm cannot be initiated.

1. While in the **MAN DOWN** menu, use AIR to place the cursor next to **PANIC**.



2. Press and release POWER MODE. The current setting flashes.
3. Use AIR to display the desired setting.
4. Press and release POWER MODE to save the setting and return to the **MAN DOWN** menu.
5. See “ESCAPE” on page 85 to return to User Mode.

Setting the Man Down Warning/Alarm Times (MAN DOWN TIME)

The Man Down Warning/Alarm times are the amount of time that has to pass between a Man Down detection and each warning/alarm. They can be set in 1 second increments from 10 - 120 seconds. When setting the Man Down Warning/Alarm times, keep in mind that **ALARM TIME ≥ WARNING 2 TIME ≥ WARNING 1 TIME**.

Table 16: Man Down Warning Alarm Time Factory Settings

Warning/Alarm	Factory Setting
WARNING 1 TIME	60 seconds
WARNING 2 TIME	75 seconds
ALARM TIME	90 seconds

1. While in the **MAN DOWN** menu, use AIR to place the cursor next to **MAN DOWN TIME**.



2. Press and release POWER MODE. The current WARNING 1 TIME setting flashes.

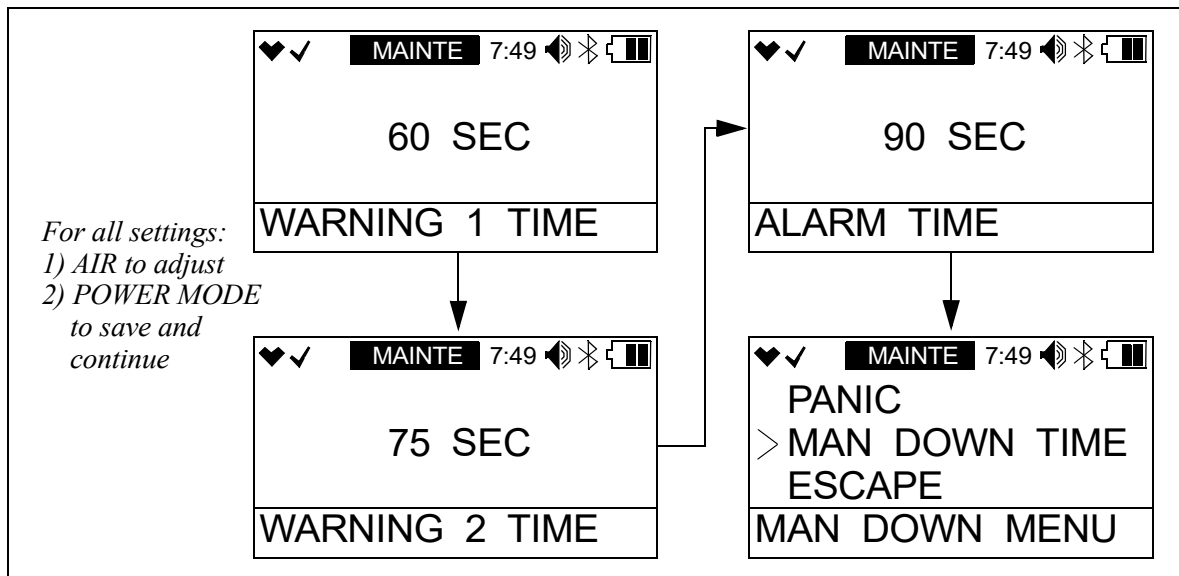

3. Use AIR to adjust the WARNING 1 TIME.
4. Press and release POWER MODE to save the setting.
5. Repeat Step 3 and Step 4 for the WARNING 2 TIME and ALARM TIME settings.
6. The instrument returns to the **MAN DOWN** menu.
7. See “ESCAPE” on page 85 to return to User Mode.

ESCAPE

1. While in the **MAN DOWN** menu, press **AIR** to scroll to **ESCAPE**.
2. Press and release **POWER MODE**. The instrument returns to User Mode.
3. See “Returning to Measuring Mode (START MEASURE)” on page 98 to return to Measuring Mode.

Alarm Settings (ALARM SETTING)

The **ALARM SETTING** menu item has 3 items: **ALARM SETTING**, **DEFAULT ALM-P**, and **ESCAPE**.

1. While in User Mode, use **AIR** to place the cursor next to **ALARM SETTING**.



2. Press and release **POWER MODE**. The first channel displays.

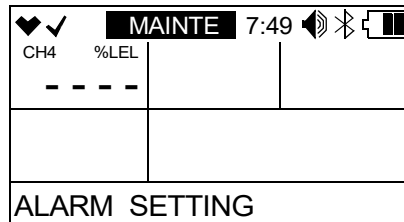

Setting the Alarm Points

1. While in the **ALARM SETTING** menu, press AIR to scroll to the instrument channel whose alarm points you want to change.

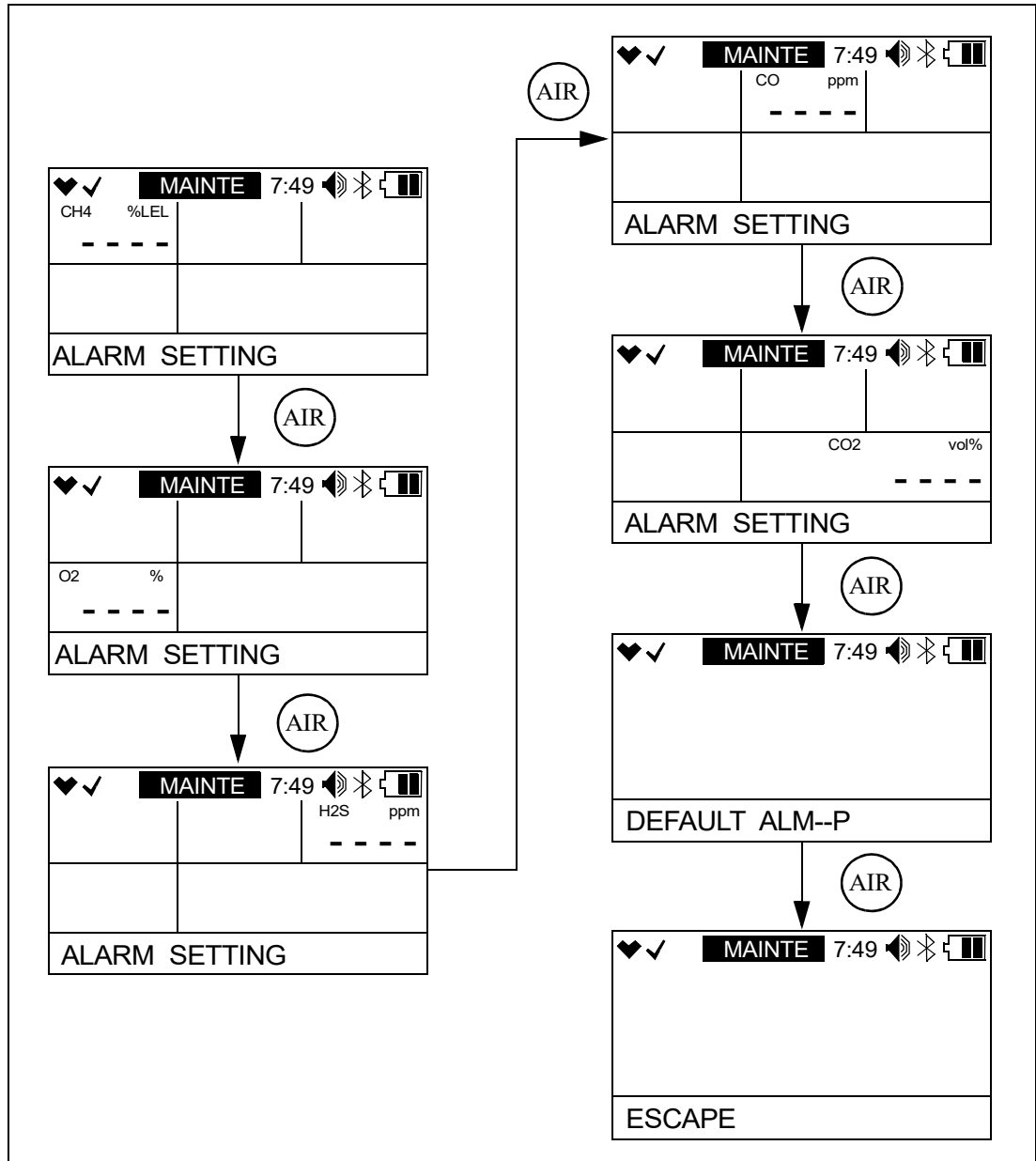

2. Press and release POWER MODE.

3. The Warning setpoint for the channel flashes. The CO channel is selected in the example below.

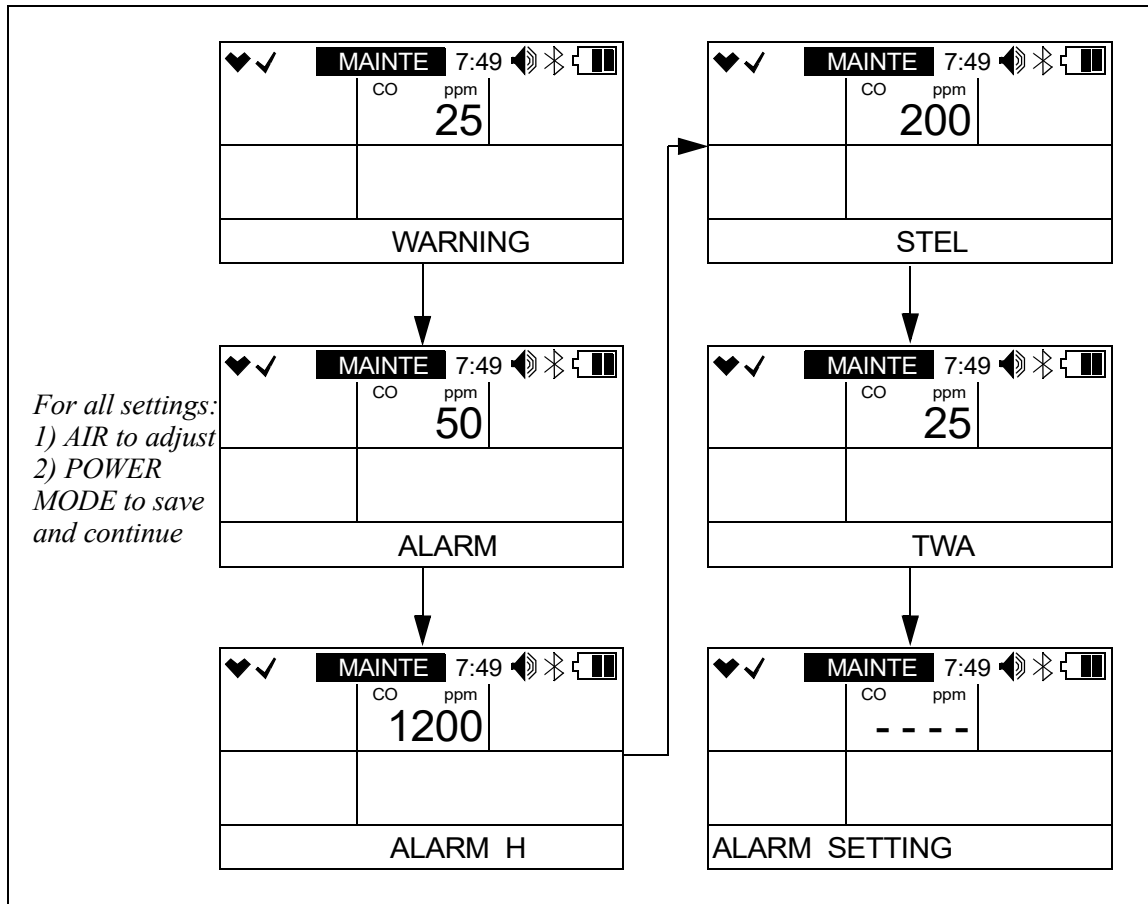

4. Use AIR to adjust the Warning setpoint. Alarm setpoint limitations are shown below.

Channel	Alarm Point Limitations
Combustible Gas	5% LEL ≤ WARNING ≤ ALARM ≤ ALARM H ≤ 60% LEL
O ₂	<ul style="list-style-type: none"> 0.0% ≤ ALARM ≤ WARNING ≤ 21.8% 20.0% ≤ ALARM H ≤ 40.0%
H ₂ S	1.0 ppm ≤ WARNING ≤ ALARM ≤ ALARM H ≤ 200.0 ppm
CO	15 ppm ≤ WARNING ≤ ALARM ≤ ALARM H ≤ 2000 ppm
CO ₂ 10,000 ppm	3,000 ppm ≤ WARNING ≤ ALARM ≤ ALARM H ≤ 9,000 ppm
CO ₂ 10% volume	0.20% volume ≤ WARNING ≤ ALARM ≤ ALARM H ≤ 8.00% volume
HCN	0.9 ppm ≤ WARNING ≤ ALARM ≤ ALARM H ≤ 30.0 ppm
NH ₃	8.0 ppm ≤ WARNING ≤ ALARM ≤ ALARM H ≤ 400.0 ppm
NO ₂	0.50 ppm ≤ WARNING ≤ ALARM ≤ ALARM H ≤ 20.00 ppm
PH ₃	0.05 ppm ≤ WARNING ≤ ALARM ≤ ALARM H ≤ 20.00 ppm
SO ₂	0.50 ppm ≤ WARNING ≤ ALARM ≤ ALARM H ≤ 100.00 ppm

5. Press and release **POWER MODE** to save the setting.
6. Repeat Step 4 and Step 5 for the Alarm, Alarm H, STEL (CO, H₂S, CO₂, and super toxic only) and TWA (CO, H₂S, CO₂, and super toxic only) settings.
7. The instrument returns to the **ALARM SETTING** menu.
8. Repeat Step 1 - Step 7 to change the alarm points for other channels.
9. See “ESCAPE” on page 88 to return to User Mode.

Defaulting the Alarm Points

Defaulting the alarm points defaults them back to factory settings as outlined in Table 1 on page 8 or to the settings saved in the **SAVE ALARM-P** menu item in Gas Select Mode if you have performed a **SAVE ALARM-P** operation.

1. While in the **ALARM SETTING** menu, press **AIR** to scroll to **DEFAULT ALM--P**.

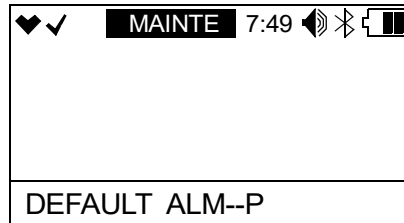

2. Press **POWER MODE** to enter the **DEFAULT ALM--P** menu item.
3. Press **POWER MODE** to perform an alarm default. Press **AIR** to return to the **DEFAULT ALM--P** menu item.
4. The instrument asks if you’re sure you want to default the alarm points. Press **POWER MODE** to default the alarm points. Press **AIR** to return to the **ALARM SETTING** menu.
5. See “ESCAPE” on page 88 to return to User Mode.

ESCAPE

1. While in the **ALARM SETTING** menu, press **AIR** to scroll to **ESCAPE**.
2. Press and release **POWER MODE**. The instrument returns to User Mode.
3. See “Returning to Measuring Mode (START MEASURE)” on page 98 to return to Measuring Mode.

Updating the Lunch Break Setting (LUNCH BREAK)

OFF (factory setting): The GX-3R Pro automatically starts new TWA and PEAK reading collection and resets the time in operation at startup.

ON: The Lunch Break Screen displays during startup. From this screen, you can choose to continue accumulating TWA and PEAK readings and the time in operation from the last time the GX-3R Pro was used or start collecting new readings and reset the time in operation.

1. While in User Mode, use **AIR** to place the cursor next to **LUNCH BREAK**.



2. Press and release **POWER MODE**. The current setting flashes.
3. Use **AIR** to display the desired setting.

4. Press and release POWER MODE to save the setting and return to User Mode.
5. See “Returning to Measuring Mode (START MEASURE)” on page 98 to return to Measuring Mode.

Setting the Confirmation Beep and Non-Compliance Indicator (CONFIRMATION)

The **CONFIRMATION** menu item has 3 items: **BEEP SELECT**, **BEEP INTERVAL**, and **ESCAPE**.

1. While in User Mode, use AIR to place the cursor next to **CONFIRMATION**.

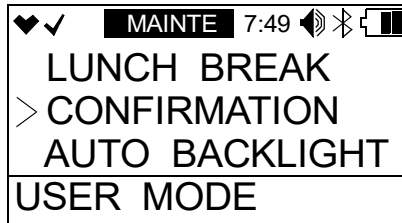

2. Press and release POWER MODE to enter the Confirmation Menu.



BEEP SELECT

BEEP SELECT defines what kind of confirmation or non-compliance indication you want to occur in Measuring Mode. The available choices are:

OFF (factory setting): The GX-3R Pro does not provide a confirmation alert or non-compliance indicator.

LED: The GX-3R Pro’s LEDs double flash as often as defined by the **BEEP INTERVAL** parameter to verify that the instrument is operating.

BUZZER: The GX-3R Pro’s buzzer double beeps as often as defined by the **BEEP INTERVAL** parameter to verify that the instrument is operating.

LED+BUZZER: The GX-3R Pro’s LEDs double flash and the buzzer double beeps as often as defined by the **BEEP INTERVAL** parameter to verify that the instrument is operating.

BUMP/CAL: If a bump test or a calibration is due and if **BUMP EXPIRED** or **CAL EXPIRED** is set to **CONFIRM TO USE** or **NO EFFECT**, the GX-3R Pro’s LEDs double flash as often as defined by the **BEEP INTERVAL** parameter to indicate a non-compliance. Once a successful bump test or calibration (depending on which is due) is done, the LEDs stop flashing.

ALARM ALERT: If the instrument goes into any gas alarm, the LEDs double flash as often as defined by the **BEEP INTERVAL** parameter to indicate a non-compliance. Once a successful bump test or calibration is done, the LEDs stop flashing.

NOTE: Depending on the **Need to get Bump Log** setting (only accessed via SDM-3R program), a data download may also be needed to clear the non-compliance.

BUMP/CAL/ALARM: The LEDs double flash to indicate a non-compliance if any of the following happens.

- a. **BUMP EXPIRED** is set to **CONFIRM TO USE** or **NO EFFECT** and a bump test is due (cleared by successful bump test).
- b. **CAL EXPIRED** is set to **CONFIRM TO USE** or **NO EFFECT** and a calibration is due (cleared by successful calibration).
- c. The instrument goes into any gas alarm (cleared by successful bump test or calibration).

NOTE: Depending on the **Need to get Bump Log** setting (only accessed via SDM-3R program), a data download may also be needed to clear the gas alarm non-compliance.

1. While in the **CONFIRMATION** menu, use AIR to place the cursor next to **BEEP SELECT**.



2. Press and release POWER MODE. The current setting flashes.
3. Use AIR to display the desired setting.
4. Press and release POWER MODE to save the setting and return to the Confirmation Menu.
5. See “ESCAPE” on page 91 to return to User Mode.

BEEP INTERVAL

The **BEEP INTERVAL** parameter defines how often the confirmation alert or non-compliance indicator selected in **BEEP SELECT** occurs. This setting only applies if the **BEEP SELECT** parameter is set to something other than **OFF**. The available choices are **0.5** minutes and **1-99** minutes in 1 minute increments. The factory setting is **5** minutes.

1. While in the **CONFIRMATION** menu, use AIR to place the cursor next to **BEEP INTERVAL**.

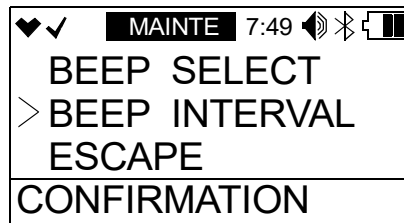

2. Press and release POWER MODE. The current setting flashes.
3. Use AIR to display the desired setting.
4. Press and release POWER MODE to save the setting and return to the Confirmation Menu.
5. See “ESCAPE” on page 91 to return to User Mode.

ESCAPE

1. While in the **CONFIRMATION** menu, use AIR to place the cursor next to **ESCAPE**.
2. Press and release POWER MODE. The instrument returns to User Mode.
3. See “Returning to Measuring Mode (START MEASURE)” on page 98 to return to Measuring Mode.

Auto Backlight in Low Light (AUTO BACKLIGHT)

The GX-3R Pro has a luminescence sensor that allows the instrument to detect how bright an environment is.

ON (factory setting): The instrument’s backlight automatically turns on in a low light environment.

OFF: The instrument’s backlight does not automatically turn on in a low light environment.

1. While in User Mode, use AIR to place the cursor next to **AUTO BACKLIGHT**.



2. Press and release POWER MODE. The current setting flashes.
3. Use AIR to display the desired setting.
4. Press and release POWER MODE to save the setting and return to User Mode.
5. See “Returning to Measuring Mode (START MEASURE)” on page 98 to return to Measuring Mode.

Updating the Backlight Time (BACKLIGHT TIME)

This setting defines how long the LCD backlight stays on when you press any button. The minimum setting is **OFF**; the maximum setting is **255** seconds. The factory setting is **30** seconds.

1. While in User Mode, use AIR to place the cursor next to **BACKLIGHT TIME**.



2. Press and release POWER MODE. The current setting flashes.
3. Use AIR to display the desired setting.
4. Press and release POWER MODE to save the setting and return to User Mode.
5. See “Returning to Measuring Mode (START MEASURE)” on page 98 to return to Measuring Mode.

Turning the Key Tone On/Off (KEY TONE)

ON (factory setting): The instrument will beep when a button is pressed.

OFF: The instrument will not beep when a button is pressed.

1. While in User Mode, use AIR to place the cursor next to **KEY TONE**.



2. Press and release POWER MODE. The current setting flashes.
3. Use AIR to display the desired setting.
4. Press and release POWER MODE to save the setting and return to User Mode.
5. See “Returning to Measuring Mode (START MEASURE)” on page 98 to return to Measuring Mode.

Display Mode Items (D MODE SETTING)

OFF: **HC GAS LIST**, **USER ID**, **STATION ID**, **INVERT SELECT**, **LCD BACKGROUND**, **BLUETOOTH**, **BUZZER VOLUME**, and **LANGUAGE** items do not appear in Display Mode.

ON (factory setting): **HC GAS LIST**, **INVERT SELECT**, **LCD BACKGROUND**, **BLUETOOTH**, **BUZZER VOLUME**, and **LANGUAGE** items appear in Display Mode. **USER ID** and **STATION ID** screens appear in Display Mode if **ID DISPLAY** in Maintenance Mode is also set to **ON** (factory setting is **OFF**).

1. While in User Mode, use AIR to place the cursor next to **D MODE SETTING**.

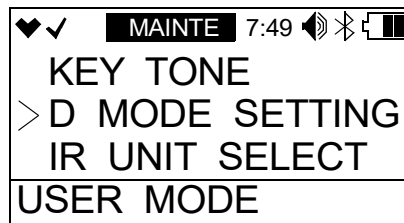

2. Press and release POWER MODE. The current setting flashes.
3. Use AIR to display the desired setting.
4. Press and release POWER MODE to save the setting and return to User Mode.
5. See “Returning to Measuring Mode (START MEASURE)” on page 98 to return to Measuring Mode.

Turning Zero Suppression On/Off (ZERO SUPPRESS)

This menu item only appears if **DISP ZERO SUP** is set to **ON** in Maintenance Mode.

The **ZERO SUPPRESS** setting is not intended for field adjustment. The default setting for each sensor is **ON**.

Sensor	Zero Suppression Value
Combustible Gas	2% LEL
O ₂	0.5% volume
H ₂ S	0.3 ppm
CO	2 ppm
CO ₂	0 ppm
HCN	0.5 ppm
NH ₃	4 ppm
NO ₂	0.30 ppm
PH ₃	0.02 ppm
SO ₂	0.20 ppm

Turning Zero Follower On/Off (ZERO FOLLOWER)

This menu item only appears if **DISP ZERO FLWR** is set to **ON** in Maintenance Mode.

The **ZERO FOLLOWER** setting is not intended for field adjustment. The oxygen channel does not support zero follower functionality. The default setting is **ON** for all other channels.

Reading Units for IR Sensor (IR UNIT SELECT)

This menu item only appears if a CO₂ sensor is installed. **IR UNIT SELECT** changes the IR sensor's units.

vol%: CO₂ readings displayed in percent volume

ppm: CO₂ readings displayed in parts per million

1. While in User Mode, use **AIR** to place the cursor next to **IR UNIT SELECT**.

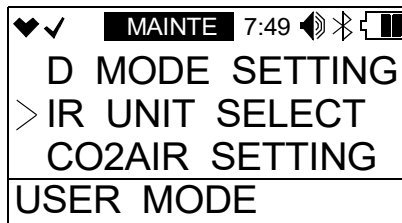

2. Press and release **POWER MODE**. The current setting flashes.

3. Use AIR to display the desired setting.
4. Press and release POWER MODE to save the setting and return to User Mode.
5. See “Returning to Measuring Mode (START MEASURE)” on page 98 to return to Measuring Mode.

CO₂ Fresh Air Adjustment On/Off (CO2AIR SETTING)

This menu item only appears if a CO₂ sensor is installed.

ON: CO₂ channel is set to 400 ppm (0.04% volume) during a demand zero, auto zero, or AIR CAL.

OFF (factory setting): CO₂ channel is not adjusted during a demand zero, auto zero, or AIR CAL.

1. While in User Mode, use AIR to place the cursor next to **CO2AIR SETTING**.



2. Press and release POWER MODE. The current setting flashes.
3. Use AIR to display the desired setting.
4. Press and release POWER MODE to save the setting and return to User Mode.
5. See “Returning to Measuring Mode (START MEASURE)” on page 98 to return to Measuring Mode.

Setting the Date/Time (DATE)

1. From the main menu, use AIR to place the cursor next to **DATE**.



2. Press and release POWER MODE. The date and time display with the year flashing.

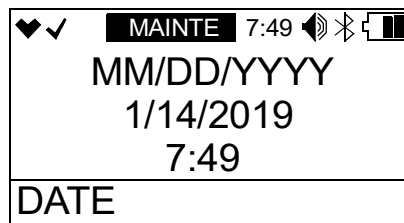

3. Use AIR to display the desired year.
4. Press and release POWER MODE to save the setting. The month setting flashes.
5. Repeat Step 3 and Step 4 to enter the month, day, hours, and minutes settings. The date and time are saved and the instrument returns to User Mode.

6. See “Returning to Measuring Mode (START MEASURE)” on page 98 to return to Measuring Mode.

Setting the Date Format (DATE FORMAT)

MM/DD/YYYY (factory setting): month/day/year.

YYYY/MM/DD: year, month, day.

DD/MM/YYYY: day, month, year.

1. While in User Mode, use AIR to place the cursor next to **DATE FORMAT**.

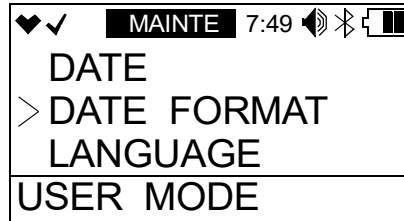

2. Press and release POWER MODE. The current setting flashes.
3. Use AIR to display the desired setting.
4. Press and release POWER MODE to save the setting and return to User Mode.
5. See “Returning to Measuring Mode (START MEASURE)” on page 98 to return to Measuring Mode.

Changing the Instrument Language (LANGUAGE)

The available languages for the GX-3R Pro are: English (factory setting), Japanese, Italian, Spanish, German, French, Portuguese, Russian, Korean, and Chinese (TC).

If you change the language to anything other than English, the **LANGUAGE** screen appears in Display Mode, allowing you to change the instrument language back to English.

1. While in User Mode, use AIR to place the cursor next to **LANGUAGE**.



2. Press and release POWER MODE. The current setting flashes.
3. Use AIR to display the desired setting.
4. Press and release POWER MODE to save the setting and return to User Mode.
5. See “Returning to Measuring Mode (START MEASURE)” on page 98 to return to Measuring Mode.

Turning the Password On/Off (USER PASSWORD)

ON: The GX-3R Pro prompts you for a password when you enter User Mode. The factory-set password is **0405** but it can be changed as desired.

OFF (factory setting): No password is required to enter User Mode.

1. While in User Mode, use AIR to place the cursor next to **USER PASSWORD**.

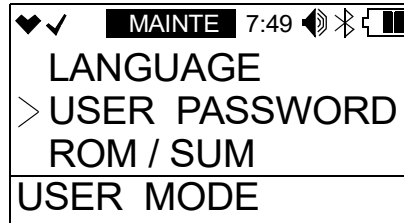

2. Press and release POWER MODE. The current setting flashes.
3. Use AIR to display the desired setting.
4. If you selected **OFF**, press and release POWER MODE to save the setting and return to the **USER PASSWORD** item in User Mode.

If you selected **ON**, continue with Step 5.

5. Press and release POWER MODE. The Set Password Screen appears. The current password displays and the first digit flashes.

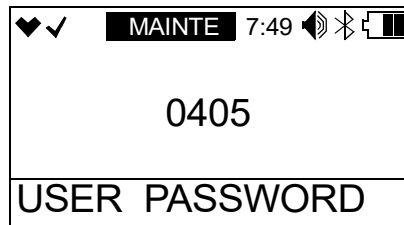

6. Use AIR to display a number from 0 to 9.
7. Press and release POWER MODE to enter the selection and advance to the next number. To go back a number, press and hold AIR and POWER MODE for a few seconds.
8. Repeat Step 6 and Step 7 to select the remaining numbers. When you press and release POWER MODE to enter the last number, the password is saved and you return to User Mode.
9. See “Returning to Measuring Mode (START MEASURE)” on page 98 to return to Measuring Mode.

Viewing the ROM/SUM (ROM/SUM)

The **ROM/SUM** screen shows the instruments’ firmware version and firmware checksum.

1. While in User Mode, use AIR to place the cursor next to **ROM/SUM**.



2. Press and release POWER MODE. The screen cycles through the main board's ROM/SUM, the sensor board's ROM/SUM, the IR sensor ROM/SUM (if an IR sensor is installed), and the Bluetooth version. The ROM is the top value and the SUM is the bottom value.

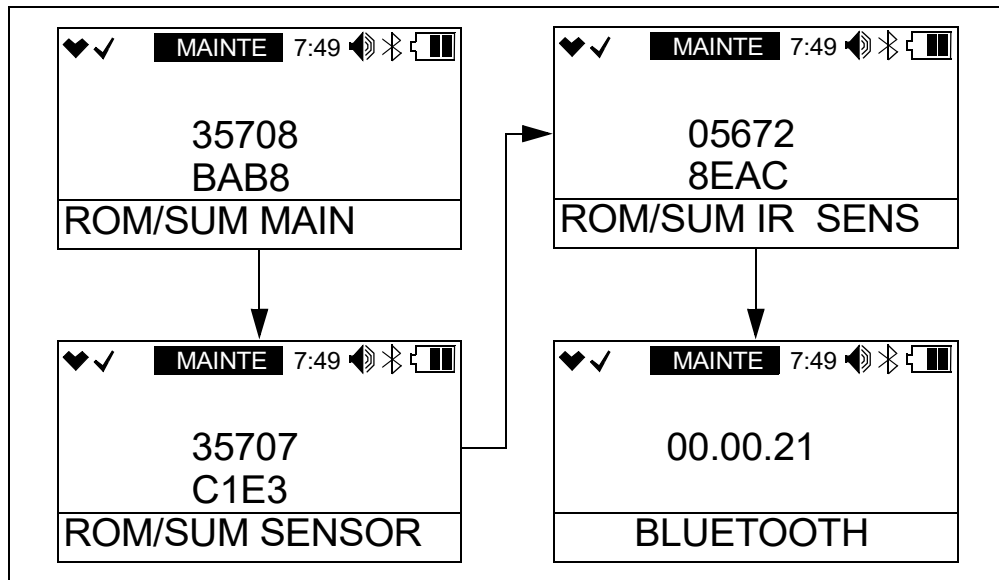

3. Press and release POWER MODE to return to User Mode.
4. See “Returning to Measuring Mode (START MEASURE)” on page 98 to return to Measuring Mode.

Viewing the Radio Standards (RADIO STANDARD)

1. While in User Mode, use AIR to place the cursor next to **RADIO STANDARD**.



2. Press and release POWER MODE. The radio standards display.

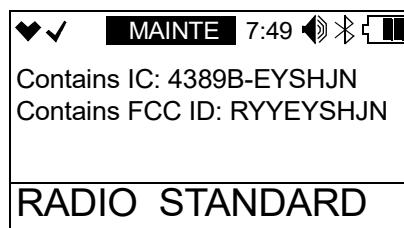

3. Press and release POWER MODE to return to User Mode.
4. See “Returning to Measuring Mode (START MEASURE)” on page 98 to return to Measuring Mode.

Returning to Measuring Mode (START MEASURE)

1. While in User Mode, use AIR to place the cursor next to **START MEASURE**.

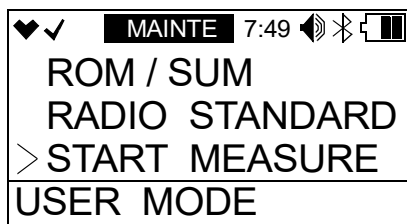

2. Press and release POWER MODE.
3. The instrument begins its start-up sequence.

Chapter 6: Maintenance

Overview

This chapter describes troubleshooting procedures for the GX-3R Pro. It also includes procedures for instrument cleaning, replacing and recharging the batteries, and replacing various consumable parts.

WARNING: *RKI Instruments, Inc. recommends that service, calibration, and repair of RKI Instruments be performed by personnel properly trained for this work. Replacing sensors and other parts with original equipment does not affect the intrinsic safety of the instrument.*

Troubleshooting

The troubleshooting table describes error messages, symptoms, probable causes, and recommended action for problems you may encounter with the GX-3R Pro.

Table 17: Troubleshooting the GX-3R Pro

Symptoms	Probable Causes	Recommended Action
<ul style="list-style-type: none">The LCD is blank.	<ul style="list-style-type: none">The unit may have been turned off.The batteries may need to be replaced or recharged.	<ol style="list-style-type: none">To turn on the unit, press and briefly hold POWER MODE.If the unit does not turn on, replace or recharge the batteries.If the difficulties continue, contact RKI Instruments, Inc. for further instruction.
<ul style="list-style-type: none">The LCD shows abnormally high or low readings but other gas detection instruments do not.	<ul style="list-style-type: none">One of the sensor's filters may need to be replaced.The GX-3R Pro may need to be recalibrated.The sensor for the affected channel(s) may need replacement.	<ol style="list-style-type: none">Replace the sensor filter.Recalibrate the unit.If the difficulties continue, replace the sensor for the affected channel(s) and calibrate the affected channel(s).If the difficulties continue, contact RKI Instruments, Inc. for further instruction.

Table 17: Troubleshooting the GX-3R Pro

Symptoms	Probable Causes	Recommended Action
<ul style="list-style-type: none"> • Calibration fails. 	<ul style="list-style-type: none"> • The calibration values may not match the cylinder gas concentrations. • The charcoal filter or charcoal half of the dual filter is saturated causing an elevated CO reading. • The sample gas is not reaching the sensors because of a bad connection. • The calibration cylinder may be out of gas or is outdated. • The sensor for the affected channel(s) may need replacement. 	<ol style="list-style-type: none"> 1. Make sure the GX-3R Pro has been properly set up for calibration. 2. Change the charcoal filter or dual filter. 3. Check all calibration tubing for leaks or for any bad connections. 4. Verify that the calibration cylinder contains an adequate supply of fresh test sample. 5. If the fail condition continues, replace the sensor(s). 6. If the difficulties continue, contact RKI Instruments, Inc. for further instruction.
<ul style="list-style-type: none"> • Heart symbol at the top of the screen becomes steadily on or disappears 	<ul style="list-style-type: none"> • A microprocessor error has occurred. 	<ul style="list-style-type: none"> • Contact RKI Instruments, Inc. for further instruction.
<ul style="list-style-type: none"> • Charge LED alternates between green and orange 	<ul style="list-style-type: none"> • Charging environment is outside the allowed 0 - 40°C charging temperature range. 	<ul style="list-style-type: none"> • Move the charger to a location that is within the allowed 0 - 40°C charging temperature range.

Instrument Cleaning

Clean the GX-3R Pro with a cloth dampened with water if it becomes excessively dirty. Do not use alcohol or other cleaning solvents.

Replacing the Batteries (Alkaline Version)

NOTE: Use Duracell MN2400 or PC2400 alkaline batteries or RKI Instruments, Inc. lithium-ion battery pack 49-1625 to maintain the CSA classification of the GX-3R Pro. Use of other batteries will void the CSA classification and may void the warranty. Do not mix old/new or different types of batteries.

NOTE: Utiliser Procell 2400 piles alcalines ou RKI Instruments, Inc. pack batterie lithium-ion 49-1625 de maintenir la classification CSA de la GX-3R Pro. L'utilisation d'autres piles annule la classification CSA et peut annuler la garantie. Ne mélangez pas les anciennes/nouvelles ou différents types de piles.

CAUTION: *Sensors, filters, and alkaline batteries are the only user-serviceable parts in the GX-3R Pro. Do not replace or modify any other part.*

WARNING: To prevent ignition of a hazardous atmosphere, batteries must only be changed in an area known to be nonhazardous.

AVERTISSEMENT: Pour éviter l'inflammation d'une atmosphère dangereuse, les piles ne doivent être remplacées que dans une zone non dangereuse.

Replace the 2 AAA batteries when the battery icon indicates that the unit is in low battery warning. When in low battery warning, the lowest battery level indication bar disappears and the battery icon will be flashing.

1. Turn off the GX-3R Pro.

WARNING: Do not remove the batteries while the GX-3R Pro is on.

2. Use a coin or a screwdriver to turn the battery cover counterclockwise.
3. Carefully remove the old alkaline batteries. Verify that the battery compartment and electrical contacts are clean.
4. Carefully install the 2 new AAA alkaline batteries according to the battery diagram inside the battery compartment. Be sure the batteries are installed in the correct orientation.

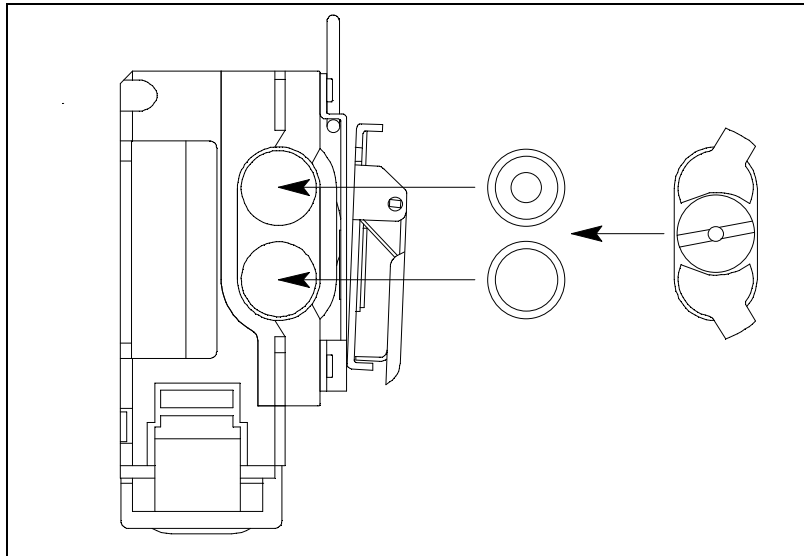

Figure 12: Installing the Alkaline Batteries

5. Use a coin or a screwdriver to turn the battery cover clockwise.
6. Turn on the GX-3R Pro and confirm that it starts up.

Recharging the Batteries (Li-ion Version)

WARNING: To prevent ignition of a hazardous atmosphere, batteries must only be charged in an area known to be nonhazardous. Charge only with RKI charger p/n 49-0133 or 49-0134. Use of other chargers will void the warranty.

AVERTISSEMENT: Pour éviter l'inflammation d'une atmosphère dangereuse, les batteries doivent uniquement être modifiés ou facturés dans une zone connue comme non dangereuse. Chargez uniquement avec le chargeur RKI réf. 49-0133 ou 49-0134. L'utilisation d'autres chargeurs annulera la garantie.

Recharge the batteries when the battery icon indicates that the unit is in low battery warning. When in low battery warning, the lowest battery level indication bar disappears and the battery icon flashes.

1. Make sure the GX-3R Pro is off.
2. Plug the AC adapter into an electrical outlet.
3. Plug the charging jack straight into the GX-3R Pro's charging socket from the top. When properly connected, a green LED turns on at the top of the GX-3R Pro.

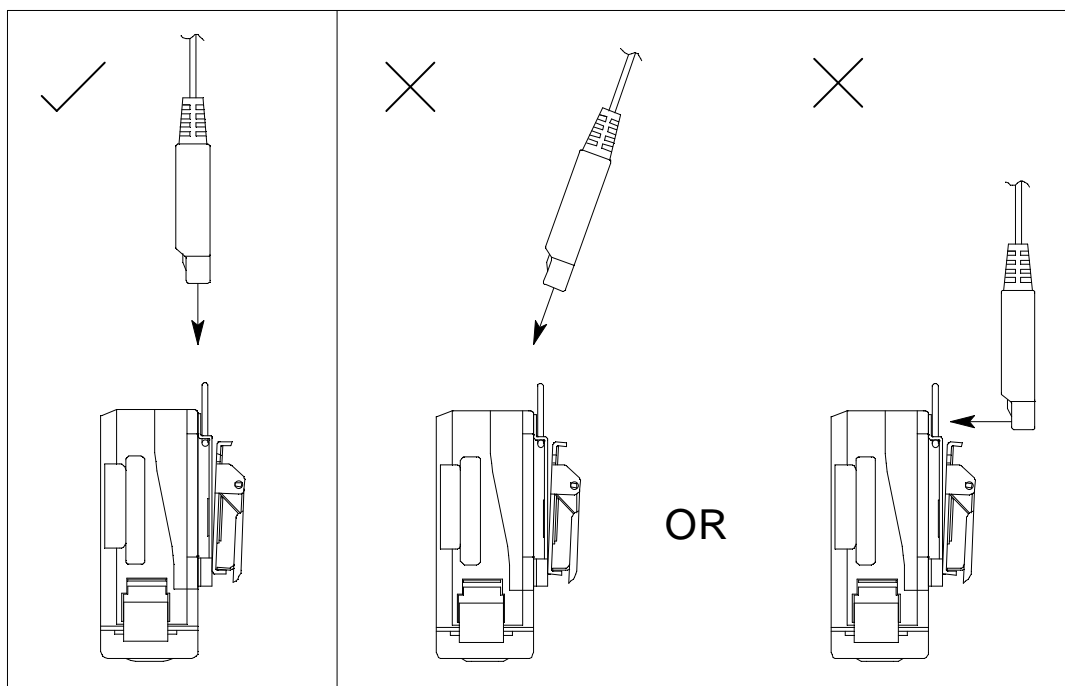

Figure 13: Connecting the Charging Cable

4. The LED at the top of the GX-3R turns orange while charging. When a full charge has been reached, approximately 3 hours, the LED turns green.

5. Pull the charging jack straight out of the GX-3R Pro's charging socket.

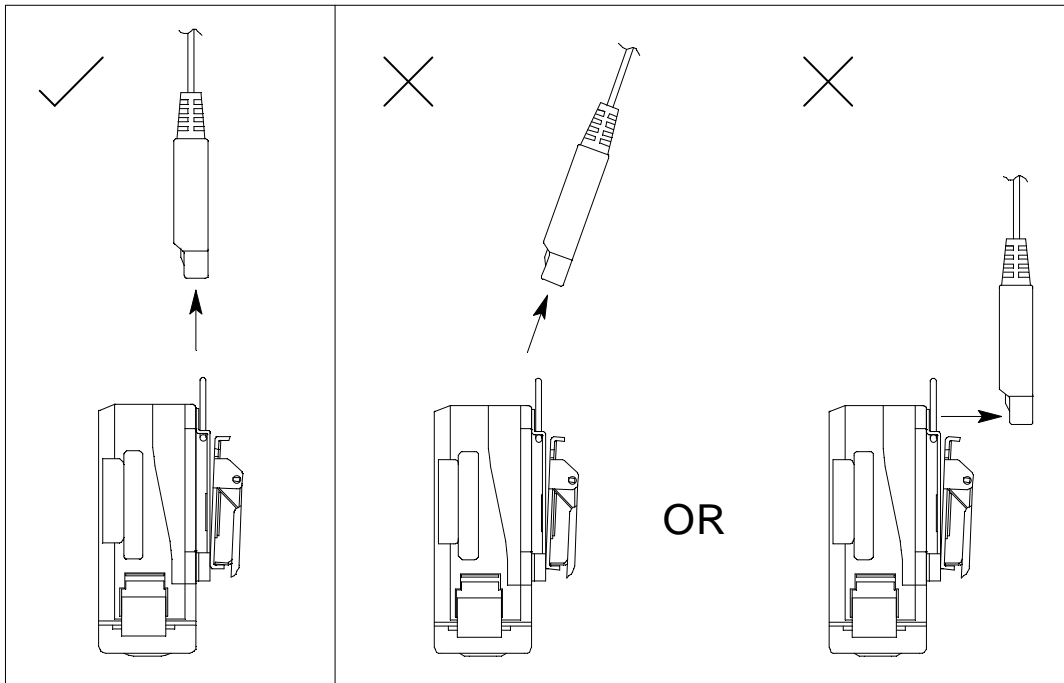

Figure 14: Removing the Charging Cable

6. Turn on the GX-3R Pro and confirm that it starts up.

Replacing the Buzzer Cover

The buzzer cover may need to be replaced if it becomes saturated or clogged with particles.

1. Remove the rubber boot from the GX-3R Pro.
2. Peel off the old buzzer cover located between the AIR and POWER MODE buttons.
3. If necessary, remove any remaining residue from the case.
4. Peel the backing off of the new buzzer cover.
5. Install the new buzzer cover between the AIR and POWER MODE buttons as shown below.

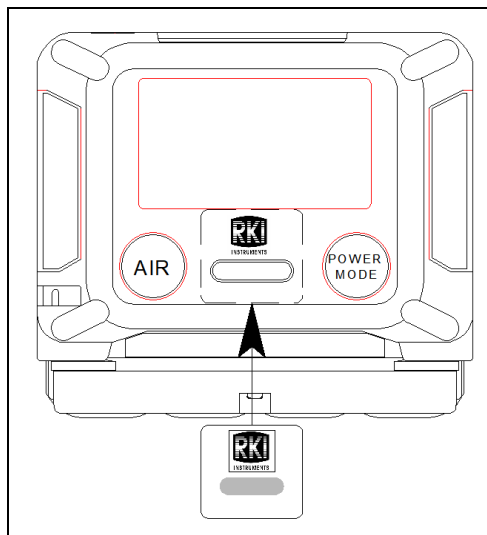

Figure 15: Buzzer Cover Replacement

6. Reinstall the rubber boot.

Replacing the Sensor Filters

CAUTION: *The buzzer cover, sensors, filters, and alkaline batteries are the only user-serviceable parts in the GX-3R Pro. Do not replace or modify any other part.*

Combustible Gas Sensor Filter: The H₂S filter disk is dark red in color and although it may darken over time, its color is not indicative of remaining filter life. The H₂S filter disk can absorb H₂S for 33 ppm hours and should be replaced after that much exposure. With this many ppm hours of absorption, the H₂S filter disk should be replaced after 80 minutes of exposure to 25 ppm H₂S. This equates to replacing the H₂S filter disk after 40 2-minute calibrations with a cylinder containing 25 ppm H₂S. If H₂S exists in the monitoring environment, the H₂S filter disk will have to be replaced more frequently.

Dual CO/H₂S Sensor Filter: The dual CO/H₂S sensor has a half black/half white filter installed over it. The filter should be replaced if you notice either 1) unexplained CO readings or 2) For users with a 1 ppm H₂S alarm point: a drift on the H₂S channel's zero reading, unexplained H₂S readings, the filter appears dirty, or every 6 months (whichever is sooner).

CO-Only Sensor Filter: A black charcoal filter is installed over CO-only sensors. The filter should be replaced if you notice unexplained CO readings.

H₂S-Only and PH₃ Sensors' Filter: A white humidity filter is installed over H₂S-only and PH₃ sensors. The filter absorbs humidity in the sampling environment to prevent unstable readings around 0 ppm. "H₂S" and "NH₃" are printed on the side of the filter.

- H₂S: For users with a 1 ppm H₂S alarm setpoint, the filter should be replaced if you notice: a drift on the H₂S channel's zero reading, unexplained H₂S readings, the filter appears dirty, or every 6 months (whichever is sooner). For users with a 2 ppm or higher H₂S alarm setpoint, the filter does not necessarily ever need to be replaced.
- PH₃: The filter should be replaced every 6 months.

NO₂ and SO₂ Sensors' Filter: The H₂S filter disk is tan in color. The filter should be replaced every 6 months.

HCN Sensor Filter: The H₂S filter disk is dark gray in color. The filter should be replaced every 6 months.

NH₃ Sensor Filter: The humidity filter is white in color. The filter should be replaced every 6 months. "NH₃" is printed on the side of the filter.

1. Verify that the GX-3R Pro is off.
2. Turn the GX-3R Pro upside down.
3. Use a small Phillips screwdriver to unscrew the two screws holding the bottom cover to the rest of the GX-3R Pro's case. Only unscrew them until the heads are flush with the edge of the bottom cover.
4. Using a small flat blade screwdriver, gently pry each side of the bottom cover away from the rest of the GX-3R Pro's case.
5. Remove the bottom cover from the rest of the GX-3R Pro's case.
6. Remove the filter gasket/sensor retainer assembly.
7. Remove the filter gasket/hydrophobic dust filter assembly.
8. Gently pry out the filter you want to replace.

9. Install the new filters.
 - a. Dark red H₂S scrubber disk for combustible gas sensor: The brown side of the filter case should face toward the GX-3R Pro.
 - b. Black and white combo filter for CO/H₂S dual sensor: The red side of the filter case should face toward the GX-3R Pro. The black filter material should face the edge of the GX-3R Pro while the white filter material should face the H₂S scrubber disk.
 - c. Black filter for CO-only sensor: The red side of the filter case should face toward the GX-3R Pro.
 - d. White filter for H₂S-only, NH₃, and PH₃ sensors: The white side of the filter case should face toward the GX-3R Pro. "H₂S" and "PH₃" are printed on the side of the filter intended for use with the H₂S-only and PH₃ sensors. "NH₃" is printed on the side of the filter intended for use with the NH₃ sensor.
 - e. Tan H₂S scrubber disk for NO₂ and SO₂ sensors: The white side of the filter case should face toward the GX-3R Pro.
 - f. Dark gray H₂S scrubber disk for HCN sensor: The white side of the filter case should face toward the GX-3R Pro.

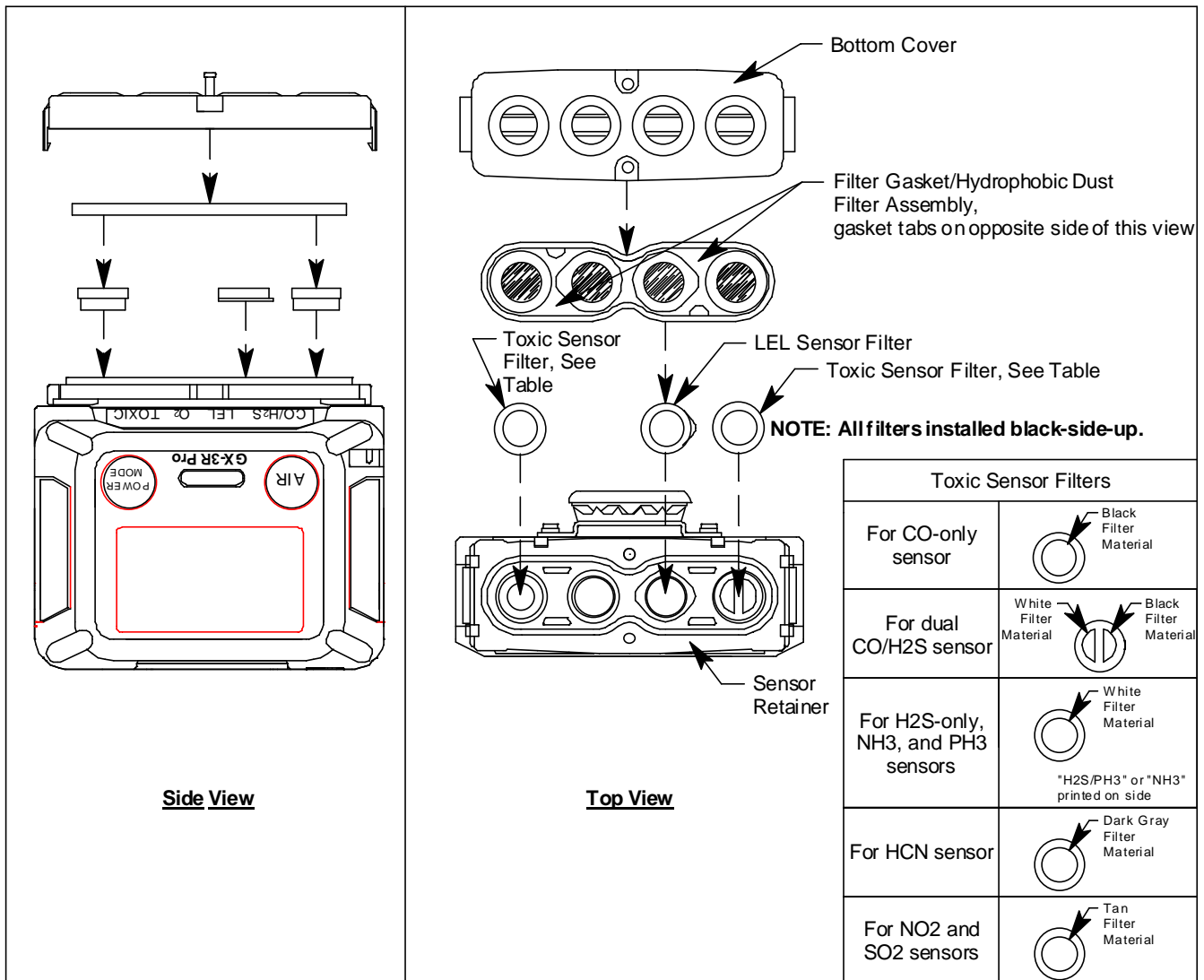

Figure 16: Replacing the Sensor Filters

- 10 . Reinstall the filter gasket/hydrophobic dust filter assembly onto the sensor retainer. The gasket tabs face down.
- 11 . Reinstall the sensor retainer over the sensors.
- 12 . Reattach the bottom cover to the GX-3R Pro. Push it onto the GX-3R Pro until it snaps into place.
- 13 . Reinstall the two screws that were loosened in Step 3.
- 14 . Bump test the GX-3R Pro as described on pg.56 to confirm good operation.

Replacing the Hydrophobic Dust Filter

Some GX-3R Pros have a hydrophobic dust filter that is not attached to the filter gasket. When replacing the hydrophobic dust filter on one of these GX-3R Pros, remove the filter and the gasket and replace it with a filter gasket/hydrophobic dust filter assembly.

- 1 . Verify that the GX-3R Pro is off.
- 2 . Turn the GX-3R Pro upside down.
- 3 . Use a small Phillips screwdriver to unscrew the two screws holding the bottom cover to the rest of the GX-3R Pro's case. Only unscrew them until the heads are flush with the edge of the bottom cover.
- 4 . Using a small flat blade screwdriver, gently pry each side of the bottom cover away from the rest of the GX-3R Pro's case.
- 5 . Remove the filter gasket/hydrophobic dust filter assembly.
- 6 . Install the new filter gasket/hydrophobic dust filter assembly with the gasket tabs facing down.

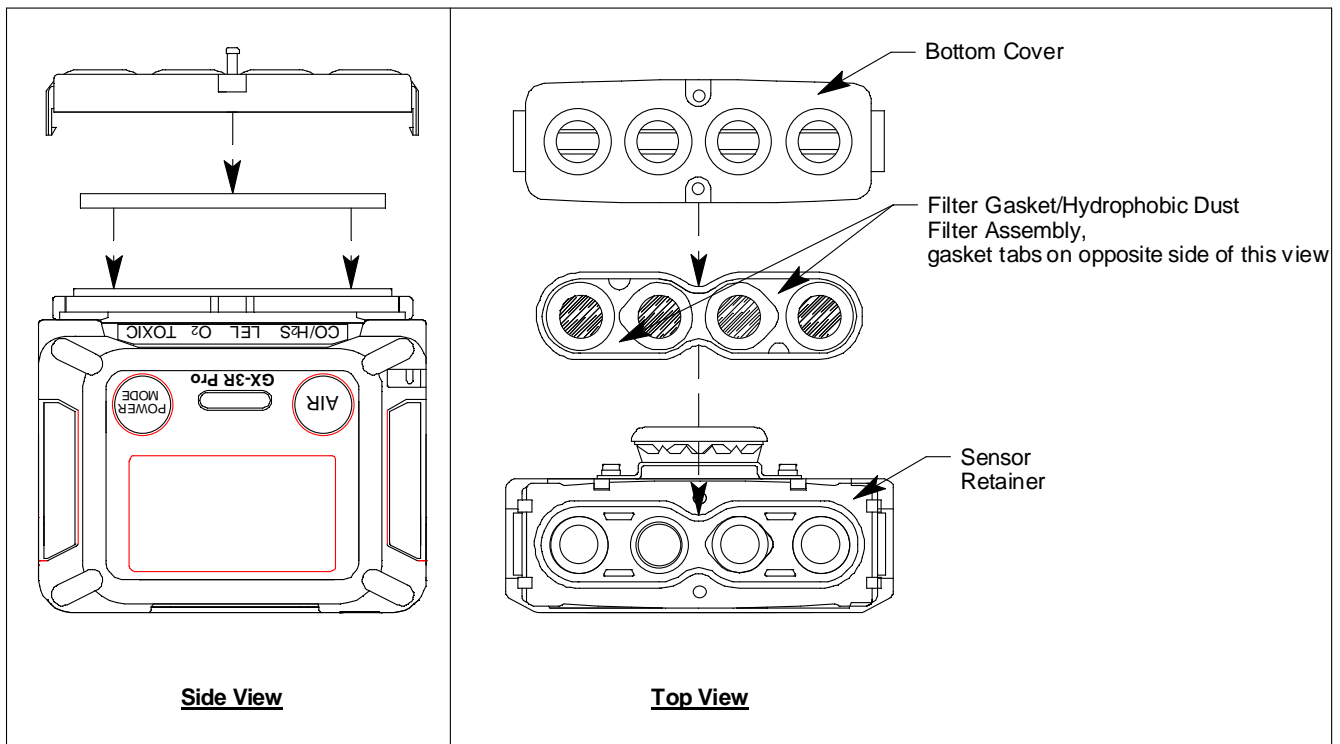

Figure 17: Replacing the Hydrophobic Dust Filter

- 7 . Reattach the bottom cover to the GX-3R Pro. Push it onto the GX-3R Pro until it snaps into place.
- 8 . Reinstall the two screws that were loosened in Step 3.

Replacing a Sensor

CAUTION: *The CO, H₂S, and super toxic sensors contain an electrolyte solution. If contact with the electrolyte occurs, wash the area immediately.*

CAUTION: *The buzzer cover, sensors, filters, and alkaline batteries are the only user-serviceable parts in the GX-3R Pro. Do not replace or modify any other part.*

- 1 . Verify that the GX-3R Pro is off.
- 2 . Turn the GX-3R Pro upside down.
- 3 . Use a small Phillips screwdriver to unscrew the two screws holding the bottom cover to the rest of the GX-3R Pro's case. Only unscrew them until the heads are flush with the edge of the bottom cover.
- 4 . Using a small flat blade screwdriver, gently pry each side of the bottom cover away from the rest of the GX-3R Pro's case.
- 5 . Remove the filter gasket/sensor retainer assembly from the GX-3R Pro. The sensors will be exposed.
- 6 . Locate the sensor you want to replace and remove it from its socket.

- Carefully insert the replacement sensor in the correct socket. Be sure that the new sensor is installed in the same position as the old sensor and that it is aligned correctly. The toxic and oxygen sensors have slots to orient the sensor. The combustible gas sensor has tabs to orient the sensor. Do not force a sensor into its slot.

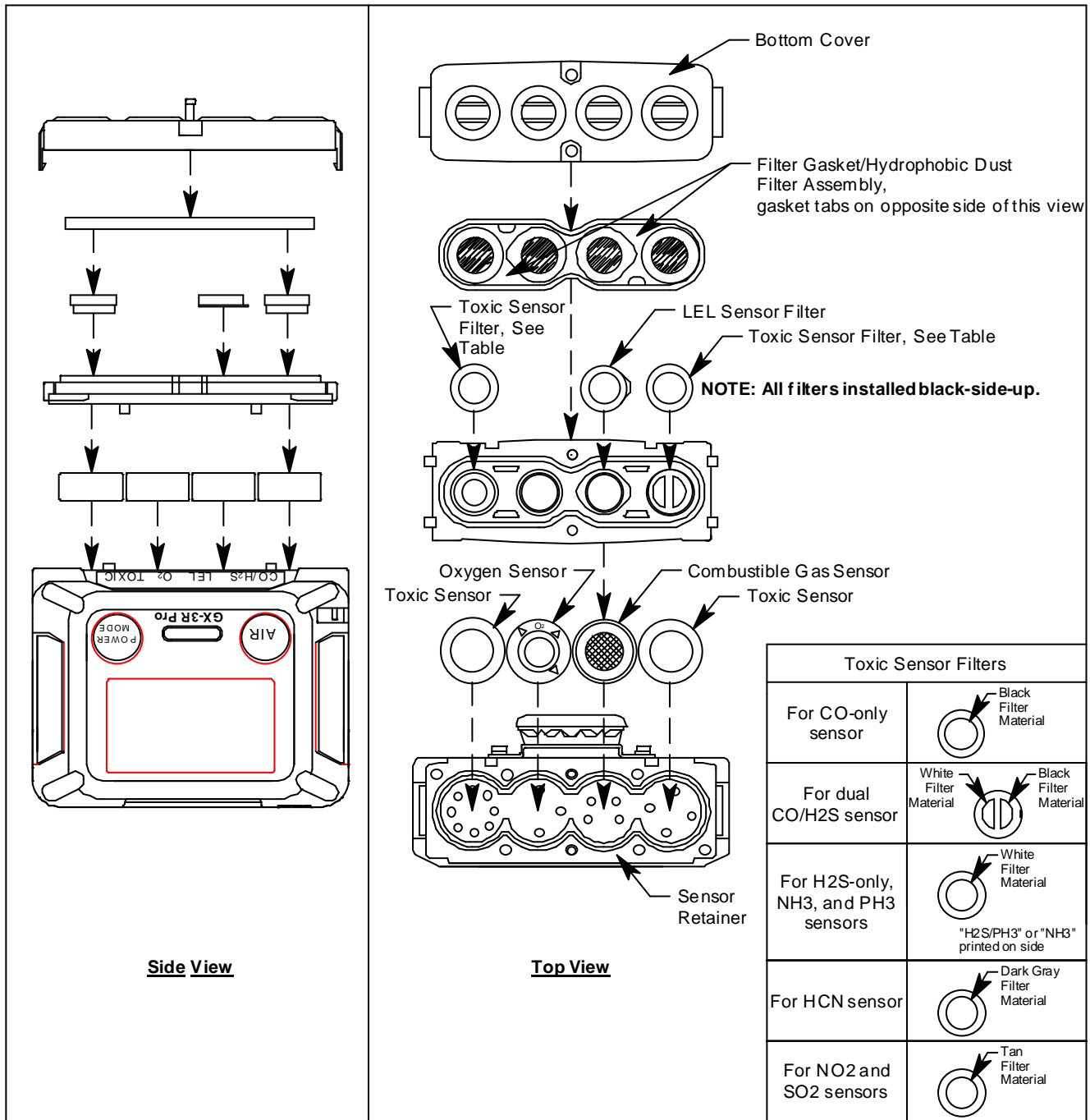

Figure 18: Replacing a Sensor

- If your instrument has a factory-installed dummy sensor, ensure that it is still installed correctly. Make sure that the flat side is facing up, away from the GX-3R Pro.
- Reinstall the filter gasket/sensor retainer assembly. The black and white filter goes over the CO/H₂S sensor with the black half of the filter facing the edge of the GX-3R Pro. Be sure the filter gasket/sensor retainer is oriented correctly.
- If the filter gasket/hydrophobic dust filter came out, reinstall it with the gasket tabs facing down.

- 11 . Reattach the bottom cover to the GX-3R Pro. Push it onto the GX-3R Pro until it snaps into place.
- 12 . Reinstall the two screws that were loosened in Step 3.
- 13 . Calibrate the new sensors as described in “Chapter 5: User Mode and Calibration” on page 50. If a new H₂-compensated CO sensor was installed, you need to calibrate with CO and set the H₂ response.

Replacing the Battery Board

Replace the battery board when the GX-3R Pro doesn't hold a charge anymore.

- 1 . Verify that the GX-3R Pro is off.
- 2 . Remove the rubber boot, if installed.
- 3 . Place the GX-3R Pro LCD-side-down.
- 4 . Unscrew the 4 screws that hold the two case halves together. The alligator or belt clip does not need to be removed.

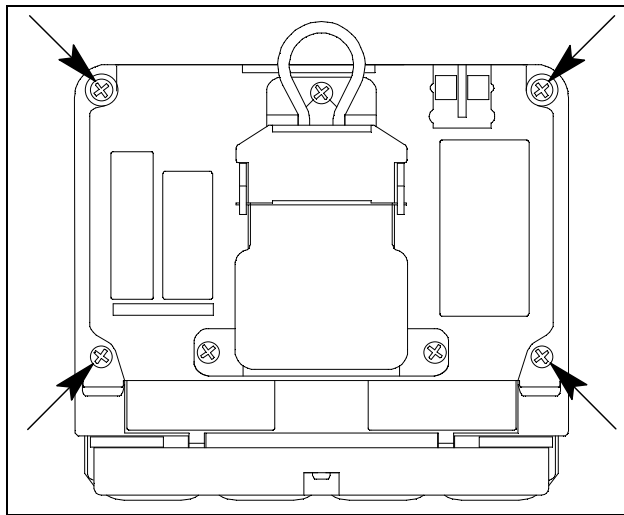

Figure 19: Removing Case Screws

- 5 . Separate the two case halves. You may need to pry them apart.
- 6 . The rear half of the case has the battery board.
- 7 . Unscrew the 3 screws that hold the battery board and plastic spacer.

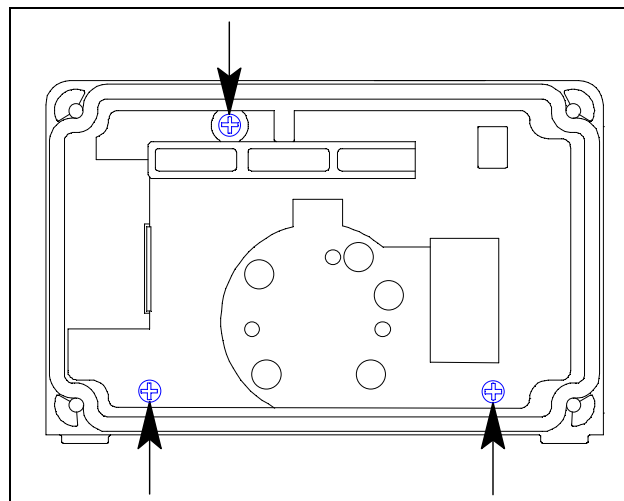

Figure 20: Removing Battery Board Screws

8. Gently remove the spacer and the battery board. A black rectangular gasket may come out with the battery board.

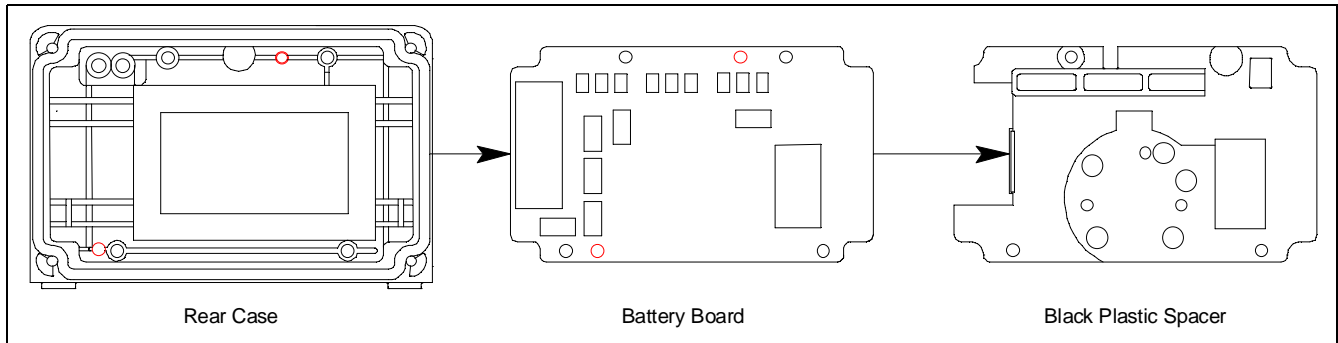

Figure 21: Removing the Battery Board

9. Place the black rectangular gasket flat in the rear case.
10. Place the new battery board battery-side-down in the rear case. The case has protrusions that fit in holes on the battery board.
11. Place the plastic spacer over the battery board.

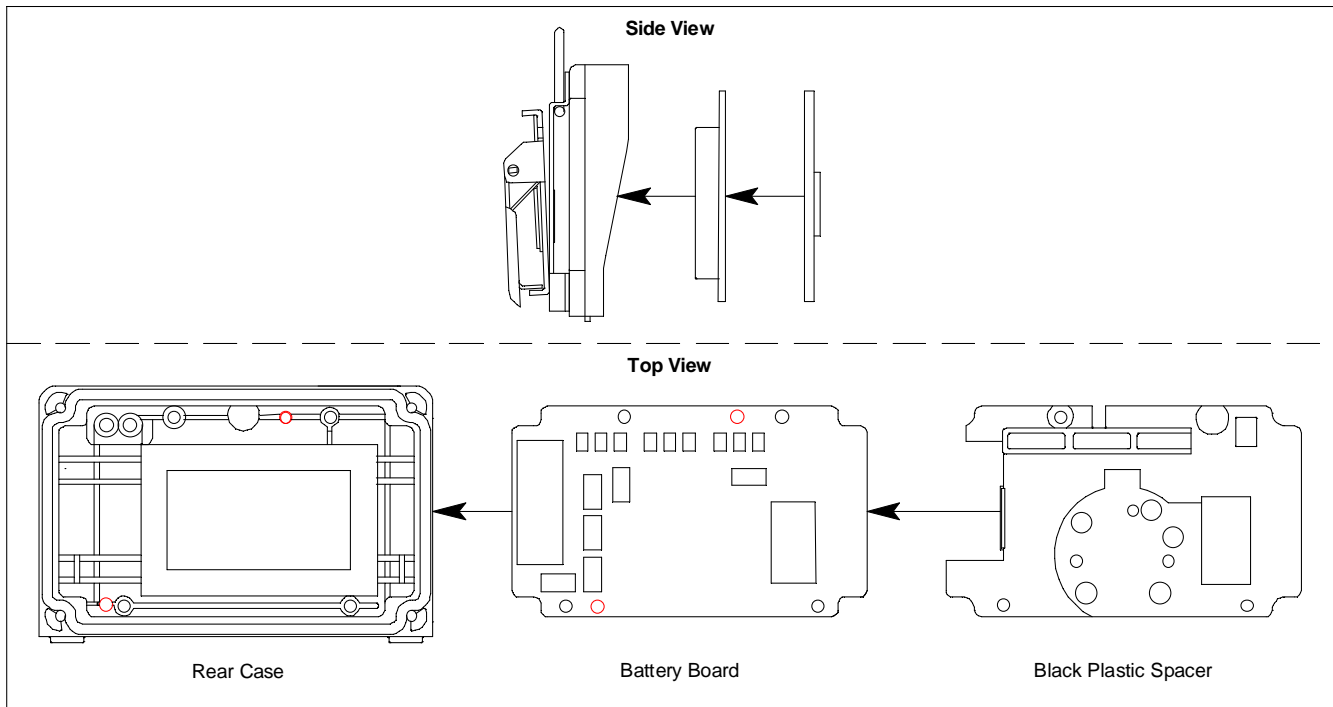

Figure 22: Reinstalling the Battery Board

- 12 . Secure the battery board and spacer using the screws removed in Step 7.

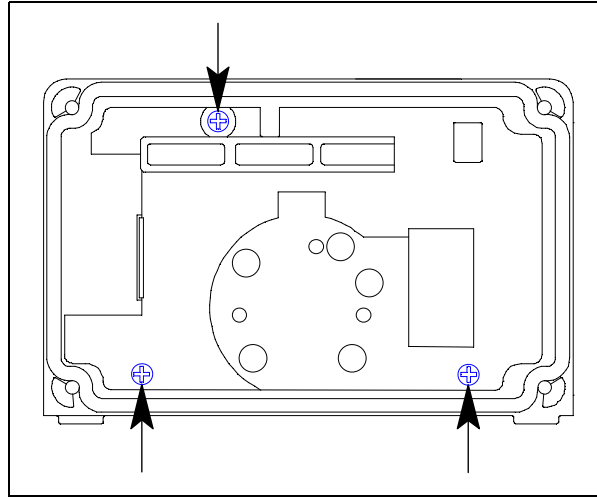

Figure 23: Reinstalling Battery Board Screws

- 13 . Be sure the gasket along the edge of the rear case is seated correctly. The flat side of the gasket faces away from the case.

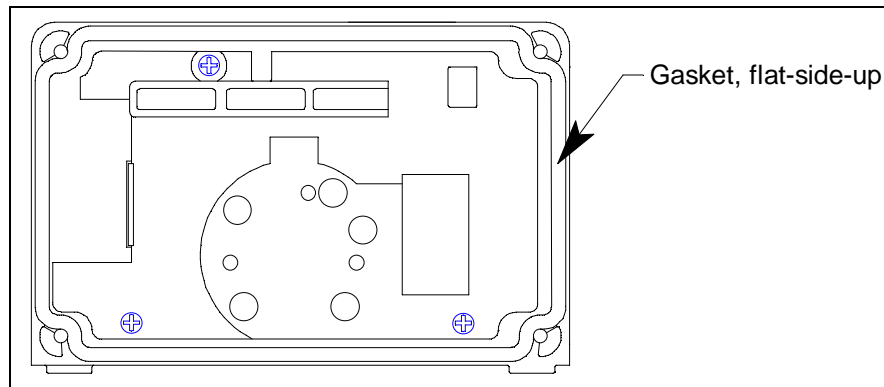

Figure 24: Reinstalling Battery Board Screws

- 14 . Reinstall the rear case to the front case using the screws removed in Step 4.

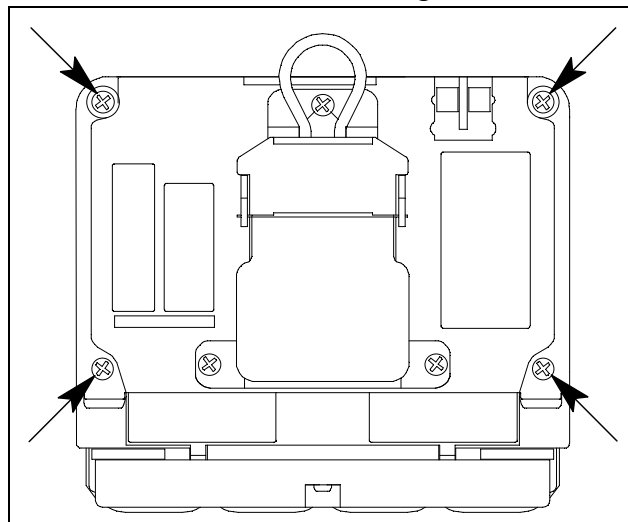

Figure 25: Reinstalling Case Screws

- 15 . Reinstall the rubber boot, if being used.
- 16 . Turn on the GX-3R Pro.
- 17 . If the instruments goes into a clock failure, set the date/time as described on pg.94.

Chapter 7: Storage and Disposal

Storage

- Store away from direct sunlight
- Store in a location with normal temperature and humidity
- Store in a location free of gases, solvents, and vapors
- Store away from dust and dirt
- The instrument must always be stored with a battery pack that is either fully charged (Li-ion version) or has fresh batteries installed (alkaline version). The sensors use a small amount of power even when the instrument is turned off. It is important to replace or recharge the batteries every 6 months during storage. If a GX-3R Pro completely loses power during storage, the date/time must be reset as described on pg.94.

Table 18: Expected Battery Life During Storage

	Alkaline Pack	Li-ion Pack
Fully charged	3 years	2 years
Low battery alarm	2 years	1 week

- To store a Li-ion battery pack by itself, discharge the battery to 1 bar in the battery icon and then remove it from the GX-3R Pro.
- To store an alkaline pack by itself, remove the batteries.

Disposal

- Remove the batteries
- Dispose in accordance with local regulations

Chapter 8: General Parts List

Table 19 lists part numbers for the GX-3R Pro's replacement parts and accessories.

Table 19: General Parts List

Part Number	Description
06-1248RK-03	Calibration kit tubing, 3 foot length
10-1086	Screw with flat and lock washers, for alligator clip
10-1087	Screw, for bottom cover and for battery pack
13-0112RK	Wrist strap
13-0124	Alligator clip with 3 installation screws
13-0125	Belt clip with 3 installation screws
20-0335	Rubber boot, black
20-0336	Heat-resistant case
20-0337	Leather case
21-1950	Screen protector
21-1960	Bottom cover
21-1961	Sensor retainer
33-0184	Filter gasket/hydrophobic dust filter assembly, 1 set (to replace hydrophobic dust filters that are separate from the filter gasket <u>and</u> to replace filter gasket/hydrophobic dust filter assemblies)
33-0184-10	Filter gasket/hydrophobic dust filter assembly, 10 sets (to replace hydrophobic dust filters that are separate from the filter gasket <u>and</u> to replace filter gasket/hydrophobic dust filter assemblies)
33-0554	Buzzer cover
33-7130	Charcoal filter /humidity filter disk (black and white), for dual CO/H ₂ S sensor, 5 pack
33-7131	H ₂ S scrubber disk (dark red), for combustible gas sensor, 5 pack
33-7132	Charcoal filter disk (black), for CO and H ₂ -compensated CO sensors, 5 pack
33-7133	Humidity filter (white), for H ₂ S and PH ₃ sensors, 5 pack
33-7134	H ₂ S scrubber disk (tan), for NO ₂ and SO ₂ sensors, 5 pack
33-7137	H ₂ S scrubber disk (dark gray), for HCN sensor
33-7140	Humidity filter (white), for NH ₃ sensors, 5 pack
47-1019	Charging cable for multi-unit charger, 2 feet
47-5084RK	USB/IrDA adapter module, no USB cable (for all premier portables)
47-5084RK-01	USB/IrDA adapter module, with USB cable (for all premier portables)

Table 19: General Parts List (cont.)

Part Number	Description
47-5085RK	USB A to USB mini cable, 6 feet, for 47-5084RK
47-5102	5 47-1019 charging cables with connector bar, no AC adapter
49-0133	Single-unit AC adapter, with 4 foot cable
49-0134	Multi-unit AC adapter, with 2 foot cables
49-2021	Single-unit DC adapter, with 4 foot cable
49-1110RK	AAA battery
49-1625	Li-ion battery pack
49-1626	Alkaline battery pack
57-2099	Replacement Li-ion battery with board
65-7004	Dummy sensor
71-0478	Operator's Manual, GX-3R Pro (this document)
71-0491	Operator's Manual, GX-3R Datalogging Program
81-0000RK-51	Calibration cylinder, 200 ppm H ₂ in air, 34 liter steel
81-0071RK-01	Calibration cylinder, 5,000 ppm CO ₂ in nitrogen, 34 liter steel
81-0071RK-03	Calibration cylinder, 5,000 ppm CO ₂ in nitrogen, 103 liter
81-0072RK-01	Calibration cylinder, 2.5 %vol CO ₂ in nitrogen, 34 liter steel
81-0072RK-03	Calibration cylinder, 2.5 %vol CO ₂ in nitrogen, 103 liter
81-0076RK-01	Calibration cylinder, zero air, 34 liter steel
81-0076RK-03	Calibration cylinder, zero air, 103 liter
81-0078RK-01	Calibration cylinder, 100% N ₂ , 34 liter steel
81-0078RK-03	Calibration cylinder, 100% N ₂ , 103 liter
81-0090RK-01	Calibration cylinder, 3-gas (CH ₄ /O ₂ /CO), 34 liter steel
81-0090RK-03	Calibration cylinder, 3-gas (CH ₄ /O ₂ /CO), 103 liter
81-0142RK-02	Calibration cylinder, 5-gas (SO ₂ , CH ₄ , O ₂ , H ₂ S, CO), 58 liter
81-0142RK-04	Calibration cylinder, 5-gas (SO ₂ , CH ₄ , O ₂ , H ₂ S, CO), 34 liter aluminum
81-0154RK-02	Calibration cylinder, 4-gas (CH ₄ /O ₂ / H ₂ S/CO), 58 liter
81-0154RK-04	Calibration cylinder, 4-gas (CH ₄ /O ₂ / H ₂ S/CO), 34 liter aluminum
81-0170RK-02	Calibration cylinder, 5 ppm SO ₂ in nitrogen, 58 liter
81-0170RK-04	Calibration cylinder, 5 ppm SO ₂ in nitrogen, 34 liter aluminum
81-0176RK-02	Calibration cylinder, 25 ppm NH ₃ in nitrogen, 58 liter

Table 19: General Parts List (cont.)

Part Number	Description
81-0176RK-04	Calibration cylinder, 25 ppm NH ₃ in nitrogen, 34 liter aluminum
81-0180RK-02	Calibration cylinder, 10 ppm NO ₂ in nitrogen, 58 liter
81-0180RK-04	Calibration cylinder, 10 ppm NO ₂ in nitrogen, 34 liter aluminum
81-0186RK-02	Calibration cylinder, 5 ppm PH ₃ in nitrogen, 58 liter
81-0196RK-02	Calibration cylinder, 10 ppm HCN in nitrogen, 58 liter
81-0196RK-04	Calibration cylinder, 10 ppm HCN in nitrogen, 34 liter aluminum
81-1050RK-25	Regulator, fixed flow, 0.25 LPM, with gauge and knob, for 17 liter and 34 liter steel cylinders (cylinders with external threads)
81-1051RK-25	Regulator, fixed flow, 0.25 LPM, with gauge and knob, for 34 liter aluminum, 58 liter, and 103 liter cylinders (cylinders with internal threads)
81-1162	Aspirator assembly: Sample cup, aspirator bulb, 10 foot hose, and probe
81-1193	Calibration cup/sample cup for aspirator assembly
81-GX3RCO	Calibration kit: 103 liter 3-gas (CH ₄ /O ₂ /CO) cylinder, 0.25 LPM regulator, calibration tubing, and case
81-GX3RCO-LV	Calibration kit: 34 liter steel 3-gas (CH ₄ /O ₂ /CO) cylinder, 0.25 LPM regulator, calibration tubing, and case
81-GX3RHSCO	Calibration kit: 58 liter 4-gas (CH ₄ /O ₂ /H ₂ S/CO) cylinder, 0.25 LPM regulator, calibration tubing, and case
81-GX3RHSCO-LV	Calibration kit: 34 liter aluminum 4-gas (CH ₄ /O ₂ /H ₂ S/CO) cylinder, 0.25 LPM regulator, calibration tubing, and case
81-GX3RHSCO-116	Calibration kit: 116 liter aluminum 4-gas (CH ₄ /O ₂ /H ₂ S/CO), 0.25 LPM regulator, calibration tubing, and case
81-PAA	Calibration kit: 58 liter 4-gas (CH ₄ /O ₂ /H ₂ S/CO) cylinder, 103 liter 5000 ppm CO ₂ in N ₂ cylinder, two 0.25 LPM regulators, calibration tubing, and case
81-PAA-LV	Calibration kit: 34 liter aluminum 4-gas (CH ₄ /O ₂ /H ₂ S/CO) cylinder, 34 liter steel 5000 ppm CO ₂ in N ₂ cylinder, two 0.25 LPM regulators, calibration tubing, and case
81-PAB	Calibration kit: 58 liter 4-gas (CH ₄ /O ₂ /H ₂ S/CO) cylinder, 103 liter 2.5% volume CO ₂ in N ₂ cylinder, two 0.25 LPM regulators, calibration tubing, and case
81-PAB-LV	Calibration kit: 34 liter aluminum 4-gas (CH ₄ /O ₂ /H ₂ S/CO) cylinder, 34 liter steel 2.5% volume CO ₂ in N ₂ cylinder, two 0.25 LPM regulators, calibration tubing, and case
81-PAC	Calibration kit: 58 liter 5-gas (CH ₄ /O ₂ /H ₂ S/CO/SO ₂) cylinder, 0.25 LPM regulator, calibration tubing, and case
81-PPA	Calibration kit: 103 liter 5,000 ppm CO ₂ in N ₂ cylinder, 0.25 LPM regulator, calibration tubing, and case
81-PPA-LV	Calibration kit: 34 liter steel 5,000 ppm CO ₂ in N ₂ cylinder, 0.25 LPM regulator, calibration tubing, and case

Table 19: General Parts List (cont.)

Part Number	Description
ESR-A13D-HCN	Hydrogen cyanide (HCN) sensor
ESR-A13D-NO2	Nitrogen dioxide (NO ₂) sensor
ESR-A13D-PH3	Phosphine (PH ₃) sensor
ESR-A13D-SO2	Sulfur dioxide (SO ₂) sensor
ESR-A13i-H2S	Hydrogen sulfide (H ₂ S) sensor
ESR-A13P-CO	Carbon monoxide (CO) sensor
ESR-A1CP-CO-H	Hydrogen-compensated carbon monoxide (CO) sensor
ESR-A1DP-COHS	Dual carbon monoxide (CO) and hydrogen sulfide (H ₂ S) sensor
ESR-B134-NH3	Ammonia (NH ₃) sensor
ESR-X13P-OXY	Oxygen sensor
IRR-0409	Carbon dioxide (CO ₂) sensor, 0 - 10% volume
IRR-0433	Carbon dioxide (CO ₂) sensor, 0 - 10,000 ppm
NCR-6309	Combustible gas sensor, catalytic

Appendix A: RK Link Phone App

Installing the App

1. Download and install the “RK Link” app from the App Store (for iOS) or Google Play (for Android).
 2. Launch the RK Link app.
 3. Allow access to device location.
 4. Allow access to contacts.
 5. Allow access to photos, media, and files.
-

Important Setup Notes

1. Make sure no other Bluetooth devices are connected to your phone.
 2. Make sure the phone’s location services are turned on. If they’re not, the coordinates in the alert emails/text messages will be blank.
-

Pairing a GX-3R Pro

Multiple instruments cannot be paired with the same phone. Similarly, one instrument cannot be paired with multiple phones.

If a paired GX-3R Pro is turned off, it must be paired with the app again when it is turned back on.

If the app is closed while a GX-3R Pro is paired, the GX-3R Pro must be paired with the app again when the app is reopened.

1. Open the RK Link app.
2. Be sure your GX-3R Pro is turned on.
3. Be sure the GX-3R Pro’s Bluetooth is turned on in the Display Mode.

If **BLE Auto Shut Off When Idle**, accessible in the Datalogging or SDM-3R Program, is **selected** (factory setting) and if the GX-3R Pro does not pair to a phone in the first 5 minutes after startup, the GX-3R Pro’s Bluetooth gets shut off to conserve battery life. If you are having trouble pairing your GX-3R Pro, the Bluetooth may have timed out.

If **BLE Auto Shut Off When Idle**, accessible in the Datalogging or SDM-3R Program, is **deselected** and if the GX-3R Pro does not pair to a phone, the GX-3R Pro’s Bluetooth stays on indefinitely.

4. Press “Pairing”.

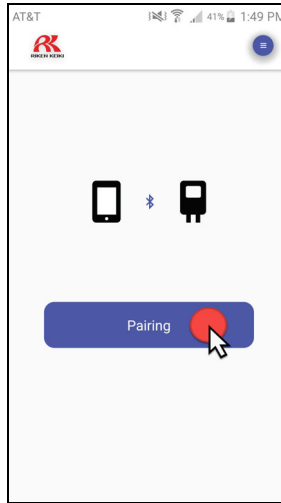

5. If your phone’s Bluetooth is not turned on, the app will prompt you to turn it on. Press “Allow”. Then press “Pairing” again.

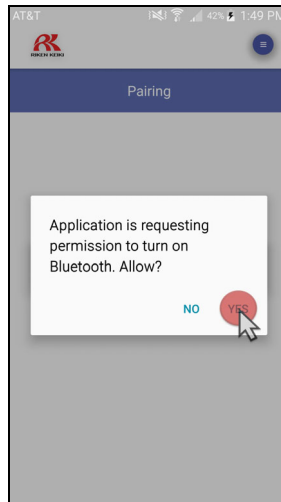

6. Select the GX-3R Pro you’d like to pair with then press “Pairing”.

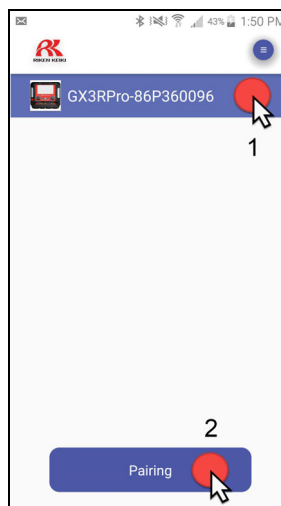

7. A “Connection completed” message appears once the GX-3R Pro is connected to your phone. Press “OK”.

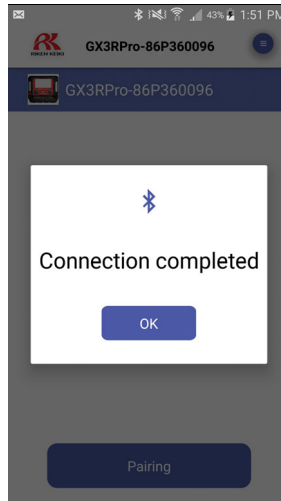

8. The Measuring Mode screen appears.

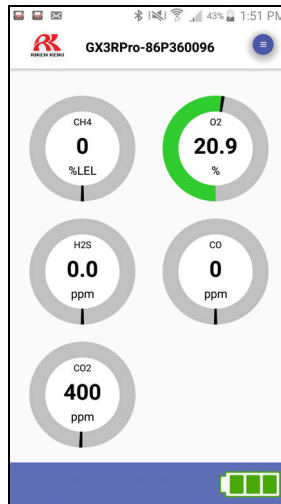

Searching for a Paired GX-3R Pro

Using the app's detector search function allows you to find a connected GX-3R Pro that may have been set down somewhere.

NOTE: This feature does not work if the GX-3R Pro is operating in stealth mode.

1. Press the  button in the upper right corner of the app.

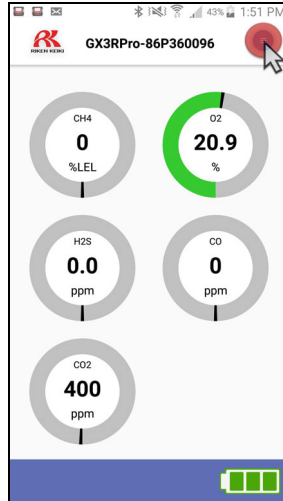

2. If necessary, scroll down to make "Detector search" visible.
3. Press "Detector search". The GX-3R Pro's buzzer, LEDs, and vibrator activate *unless the GX-3R Pro is operating in Stealth Mode*. If the GX-3R Pro is operating in Stealth Mode, the GX-3R Pro will not respond to a detector search.

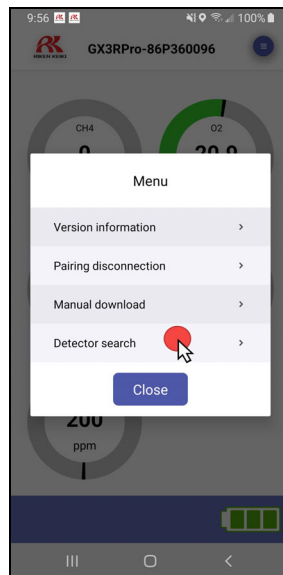

Disconnecting a Paired GX-3R Pro

1. Press the  button in the upper right corner of the app.

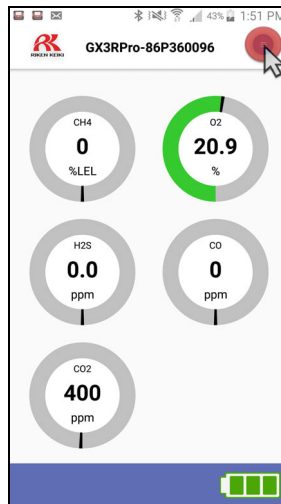

2. If necessary, scroll down to make “Pairing disconnection” visible.
3. Press “Pairing disconnection”. The GX-3R Pro is disconnected from the phone but remains on and functional.

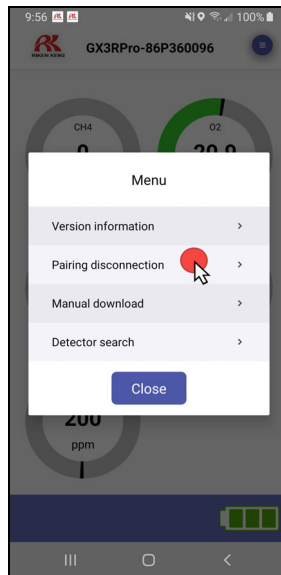

4. If **BLE Auto Shut Off When Idle**, accessible in the Datalogging or SDM-3R Program, is **selected** (factory setting), the GX-3R Pro’s Bluetooth stays on for 5 minutes after disconnection. After 5 minutes, the GX-3R Pro’s Bluetooth gets shut off to conserve battery life. If you want to pair to the GX-3R Pro after 5 minutes of disconnection, you will need to turn the Bluetooth back on in Display Mode.

If **BLE Auto Shut Off When Idle**, accessible in the Datalogging or SDM-3R Program, is **deselected**, the GX-3R Pro’s Bluetooth stays on indefinitely after disconnection. You can pair to the GX-3R Pro at any point after disconnection.

Adjusting App Notification Settings

1. Press the  button in the upper right corner of the app.

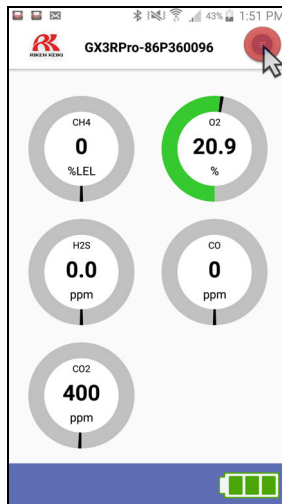

2. Press “Application settings”.

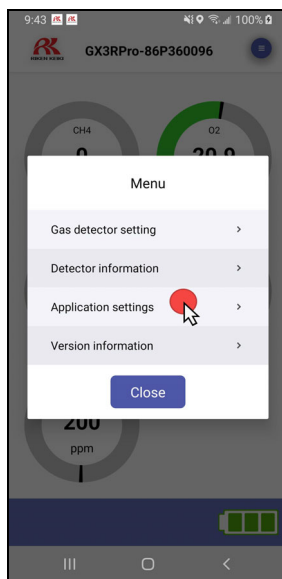

3 . The app notification settings appear.

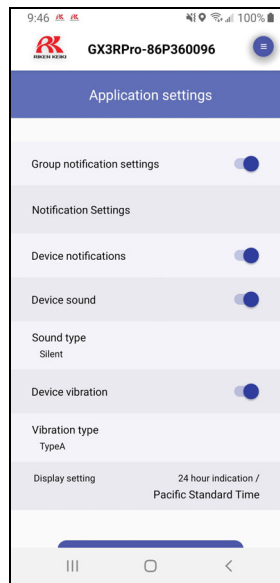

- Group notification settings: If set to on, emails and text messages are sent out as long as the Group Settings window is set up appropriately. If set to off, emails and text messages are not sent out even if the Group Settings window is set up appropriately.
- Device notifications: If set to on, the app provides notifications for past due bump tests or calibrations, gas alarms, man down alarms, and any faults. Notifications can be viewed in your phone's notification bar. If set to off, the app does not provide notifications.
- Device sound: If set to on, the app produces a notification sound. If set to off, the app does not produce a notification sound.
- Sound type: Define the app's notification sound.
- Device vibration: If set to on, the app vibrates when a notification occurs. If set to off, the app does not vibrate when a notification occurs.
- Vibration type: Define the app's vibration pattern.
- Display setting: Indicates the time format and time zone. This is not adjustable.

Defining Owner Information

Owner information can be defined with or without a GX-3R Pro paired with the app. Owner information gets sent out with email alerts along with the station ID and user ID from the GX-3R Pro.

1. Press the  button in the upper right corner of the app.

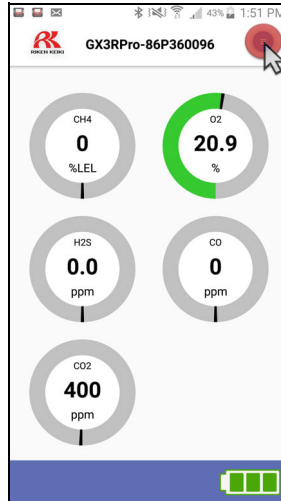

2. Press “Application settings”.

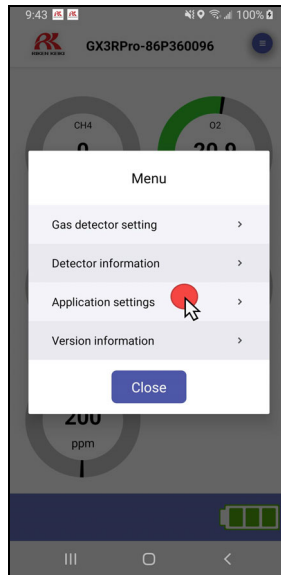

- 3 . Press “Owner information setting” at the bottom of the screen. You may need to scroll down to make it visible.

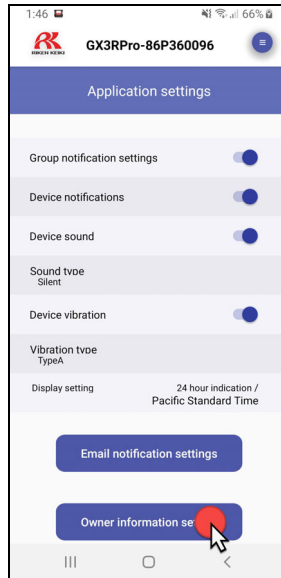

- 4 . Type in the name, company name, and department name.

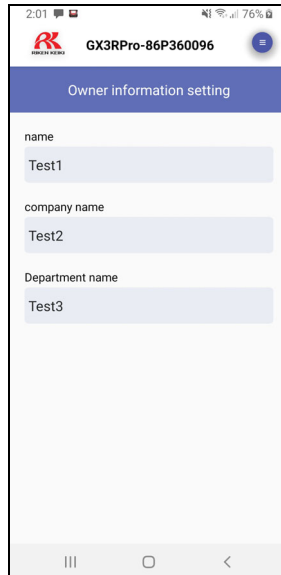

Setting Up Email/Text Alerts

Email and text alert setup can be done with or without a GX-3R Pro paired with the app.

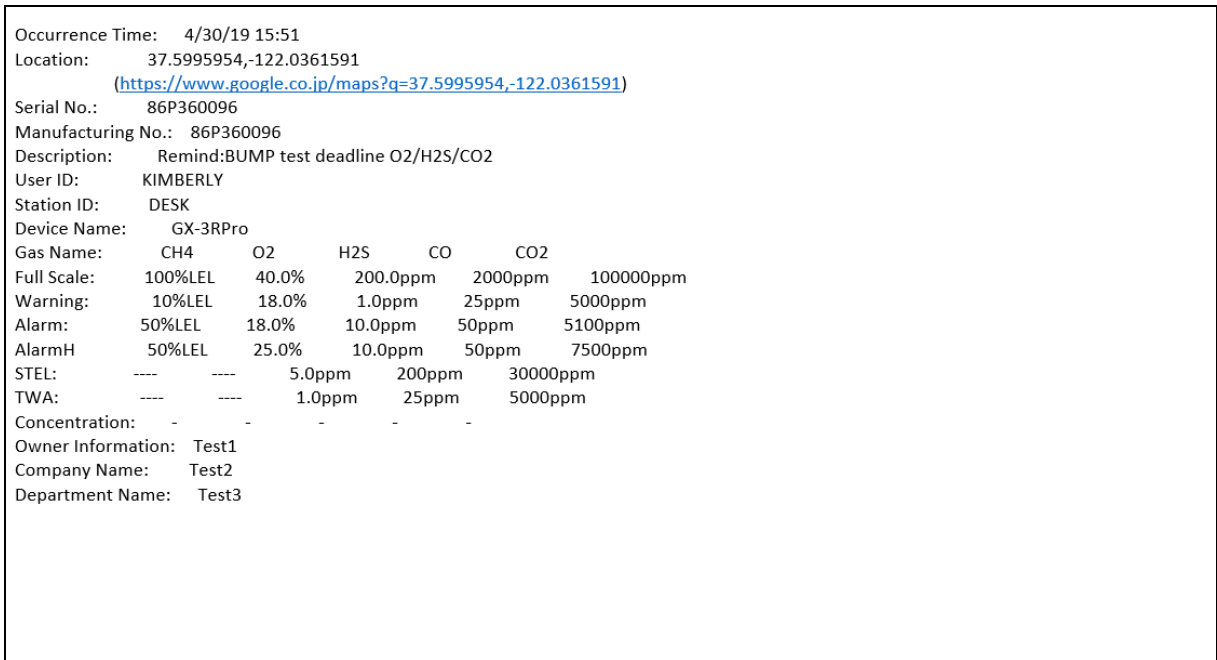

Figure 26: Email Alert for Past Due Bump Test

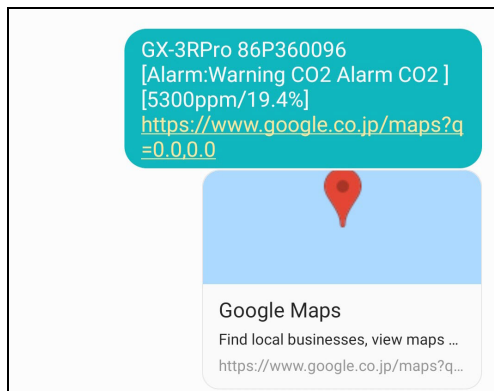

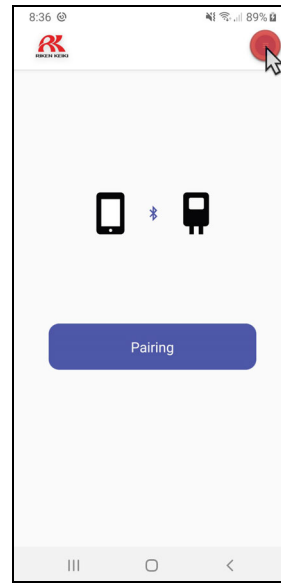

Figure 27: Text Alert for CO₂ Warning and Alarm

1. Press the  button in the upper right corner of the app.



GX-3R Pro Connected



GX-3R Pro Disconnected

2. Press "Application settings".

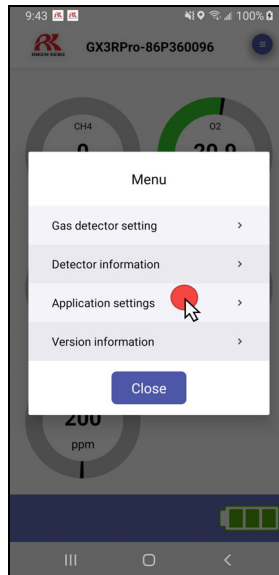

3 . Make sure “Group notification settings” is turned on.

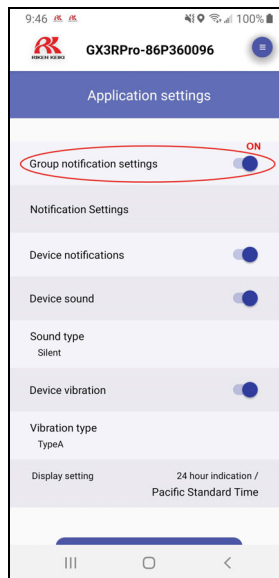

4 . Press “Notification Settings”.

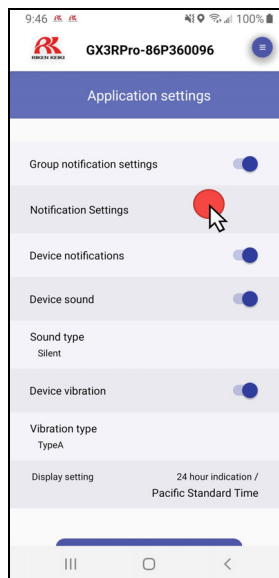

5. Make sure “Application Server” is selected in the “Text Service” and “Email Service” sections.

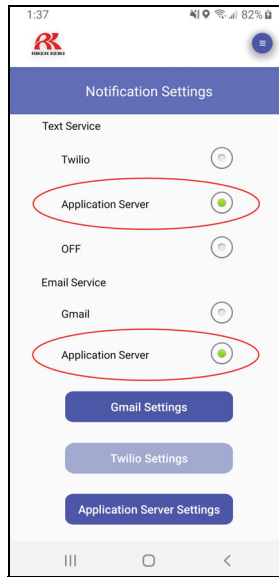

6. Press “Application Server Settings”.

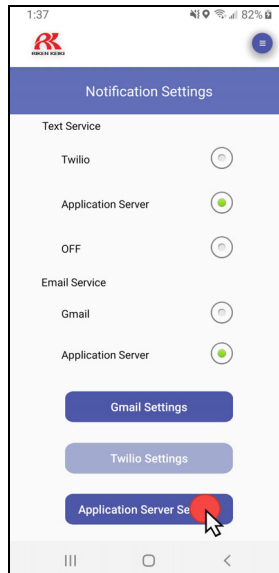

7. Enter your first name, last name, phone number, and email address. All fields are required for the notifications to function.

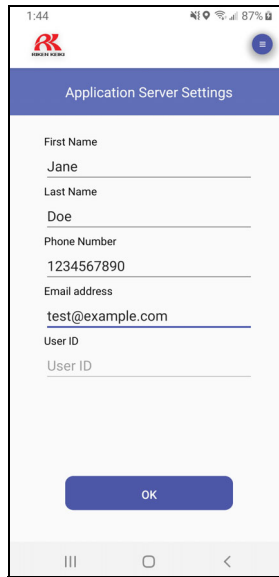

8. Press "OK". A User ID is automatically generated.



9. Use your phone's "Back" button or the  button to get back to the "Application Settings" screen.

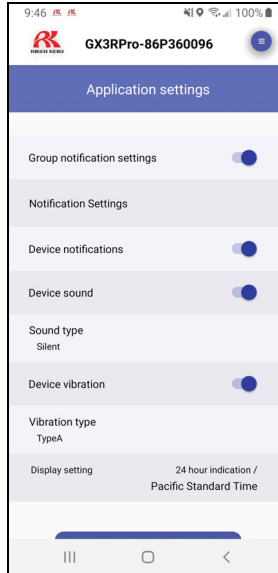

10. Press "Email notification settings" at the bottom of the screen.

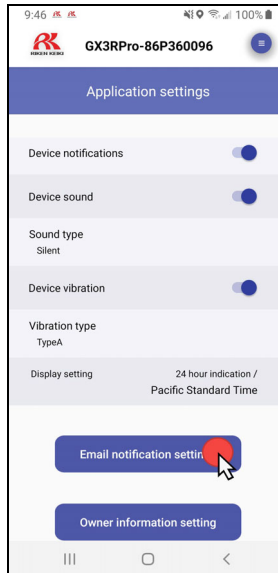

11 . Type in a group name and press “New registration”.

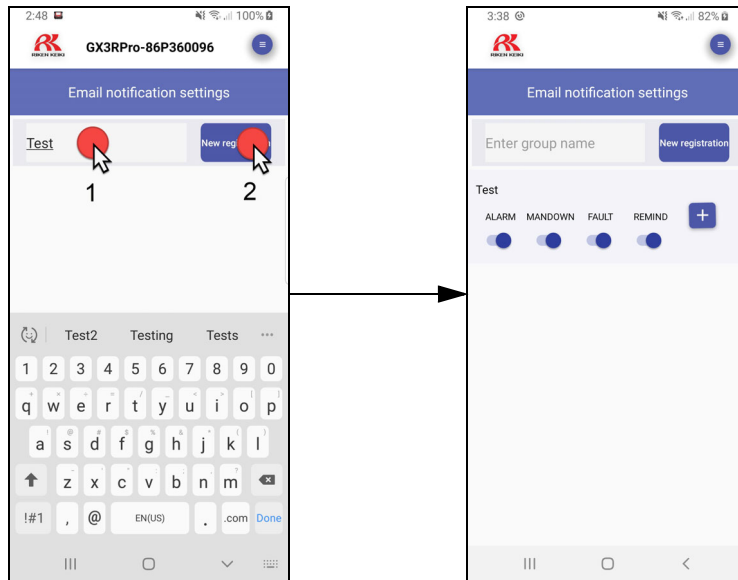

12 . To delete a group name once it’s entered:

- a. Press the  button.
- b. Press “Delete group”. You may need to scroll down to make “Delete group” visible.
- c. Press each group you want to delete. A check mark appears to the right of the group name.
- d. Press “OK” at the bottom of the screen to delete the selected group(s).

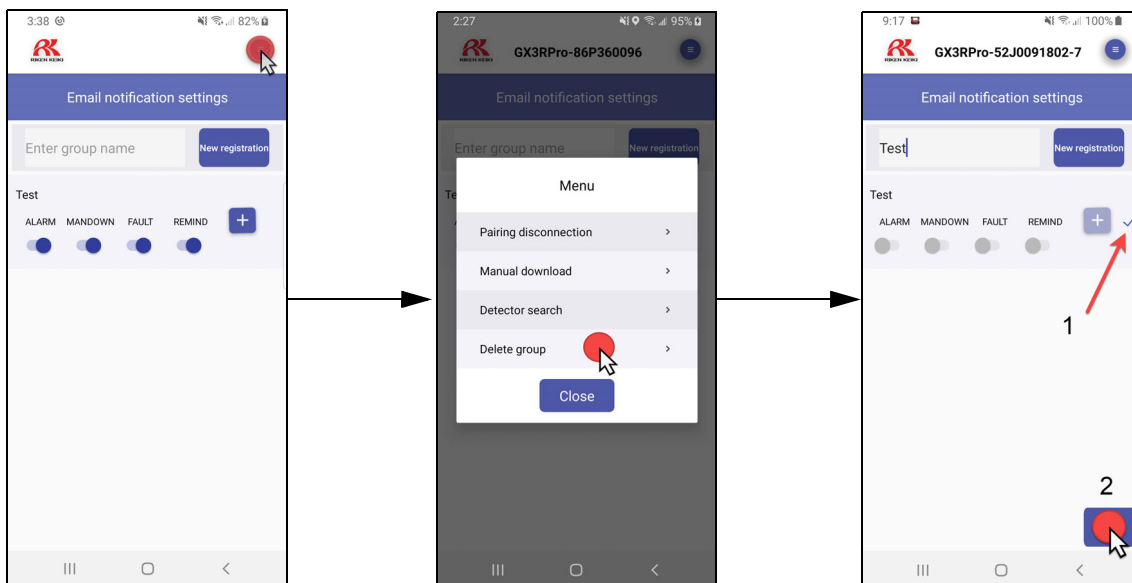

13 . Choose the alarm types that will initiate an email or text alert then press the “plus” symbol.

- ALARM: Sends an alert or notification for any gas alarm (warning, alarm, alarm H, STEL, TWA).
- MANDOWN: Sends an alert or notification for a man down alarm.
- FAULT: Sends an alert or notification for any sort of instrument, battery, or sensor failure

- REMIND: Sends an alert or notification if the instrument is due for a bump test or calibration regardless of the instrument’s reminder on/off setting.

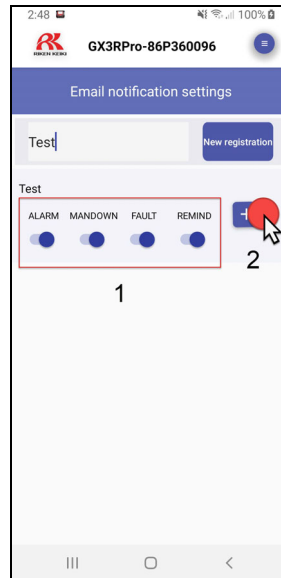

- 14 . Type in an email address or phone number and press “New registration” to add the email address/phone number to the list.



- 15 . To add contacts from your phone:
 - a. Press the  button.
 - b. Press “Register from Phone Book”. You may need to scroll down to make “Register from Phone Book” visible.

c. Select each contact you want to use. A check mark appears to the right.

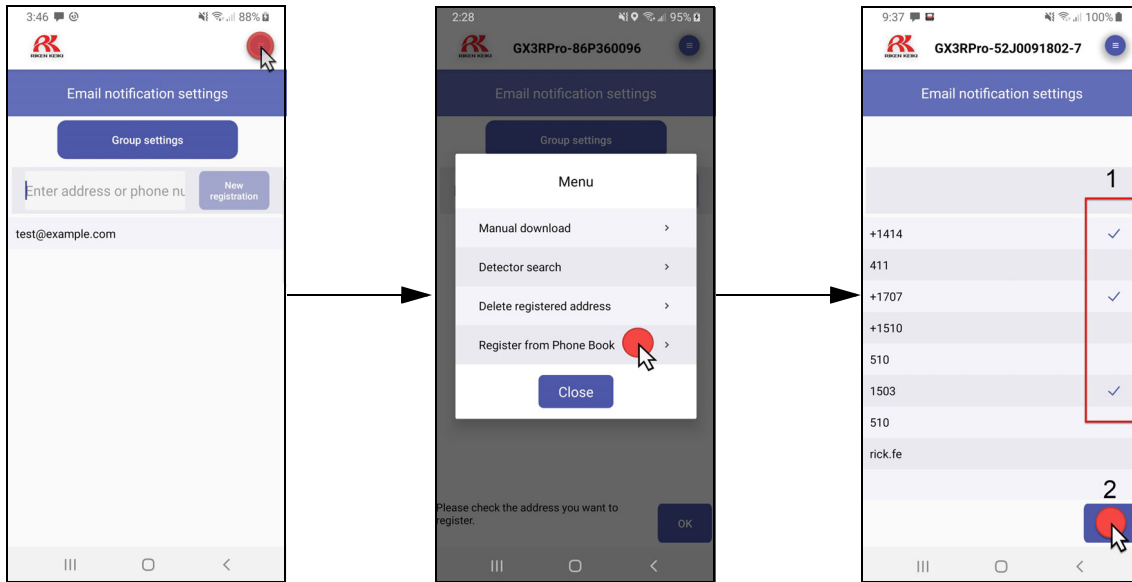

16. Press the new email address/phone number and confirm that a check mark appears to its right. If there is no check mark, that email address/phone number will not be included in the alert!

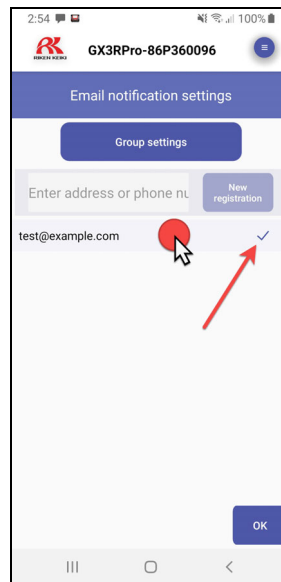

17. To delete an email address/phone number once it's entered:

- Press the  button.
- Press "Delete registered address". You may need to scroll down to make "Delete registered address" visible.
- Press each email address/phone number you want to delete. A check mark appears to its right.

- d. Press “OK” at the bottom of the screen to delete the email address(es)/phone number(s).

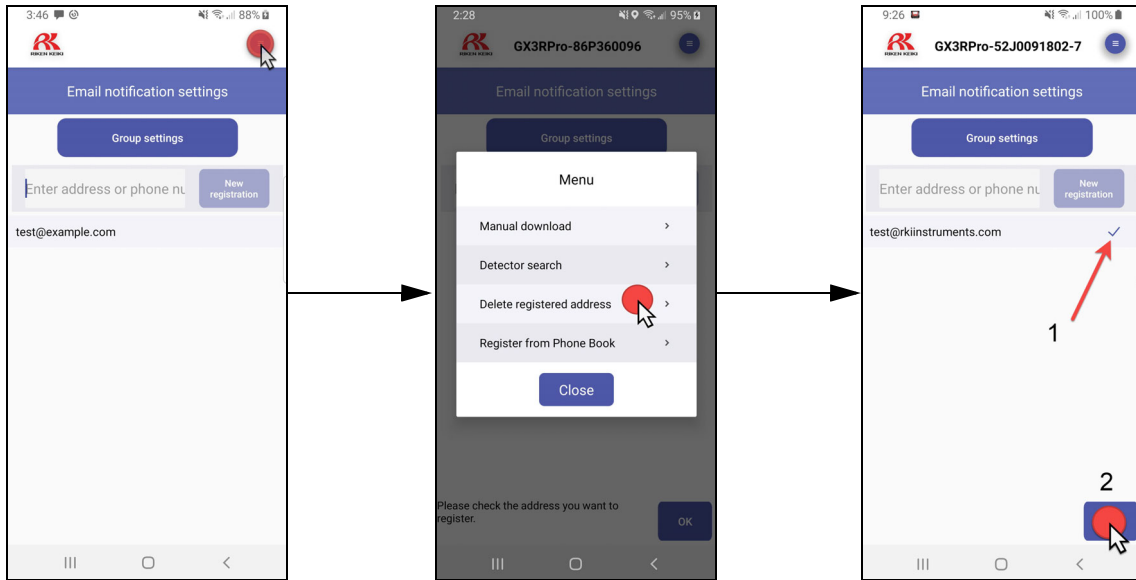

- 18 . Press OK. You will be returned to the group settings screen. To add another group, type in a new name and press “New registration”. Repeat steps 6 - 9.
- 19 . Use your phone’s “Back” button to return to the Measuring Mode screen.
- 20 . To get a map preview to appear in the text message recipients’ message window:
 - a. Recipient must add 510.800.5926 to their contacts.
 - b. For Android phones, turn the link preview feature on in the message settings window.

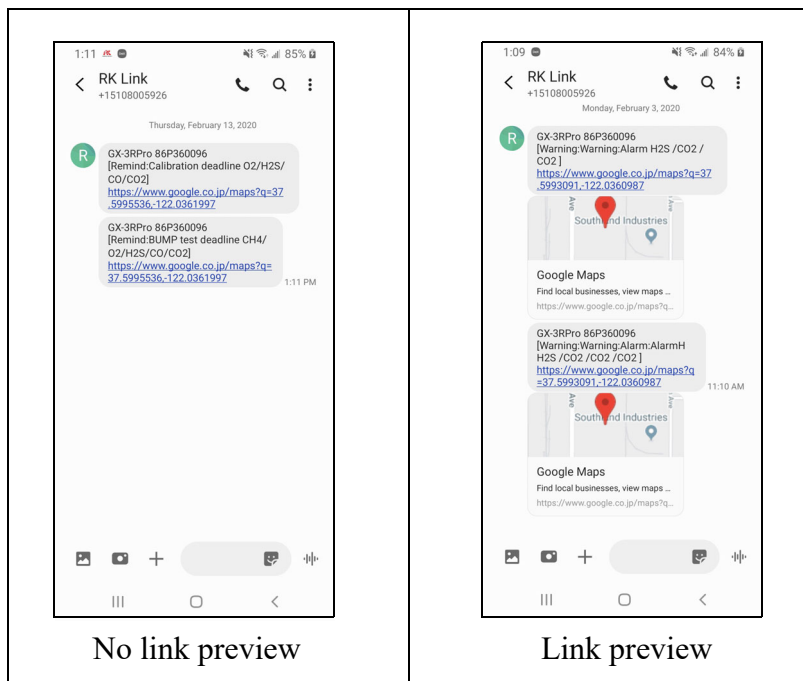

Changing GX-3R Pro Parameters

GX-3R Pro parameters can only be viewed or changed when a GX-3R Pro is paired with the app.

Entering the Gas Detector Setting Menu

1. From the home screen, press the  button in the upper right corner of the app.

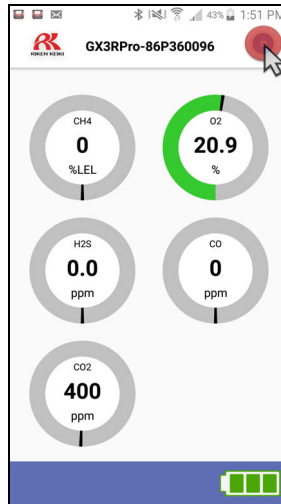

2. Press “Gas detector setting”.

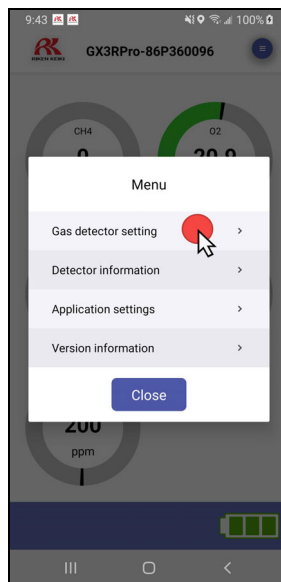

3. Type in the password and press “OK”. The password depends on your instrument settings.
 - For brand new instruments whose User Mode Password parameter has not been adjusted, the password is **0000**.
 - If you turned your instrument’s User Mode Password on, the app’s password is your instrument’s User Mode password.
 - If you turned your instrument’s User Mode Password on but then turned it off, the app password is still the instrument’s old User Mode password. The app password does not go back to **0000** after you turn off the instrument’s User Mode password.

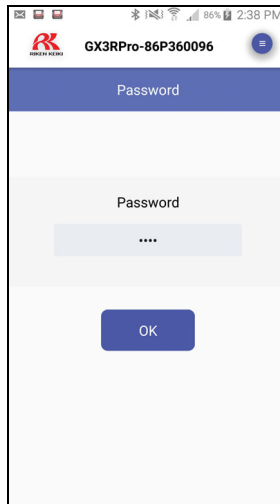

Alarm Settings

- 1 . Access the Gas Detector Setting Menu as described on pg.136.
- 2 . Press “Alarm Setting”.

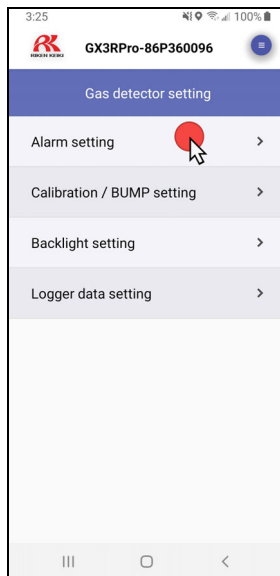

3. Press the channel whose alarm points you want to view or change. The H₂S channel is selected in the example below.

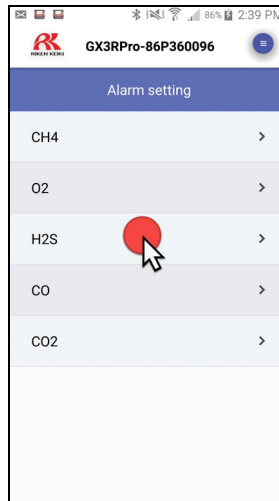

4. The alarm points are displayed.

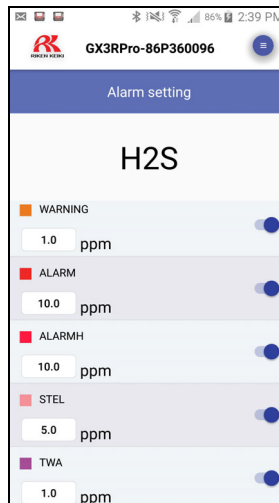

5. Turn the alarms on or off with the toggle button next to each alarm type.
6. Adjust the alarm setpoints by pressing the current setpoint and scrolling to the desired value.

Calibration and Bump Settings

1. Access the Gas Detector Setting Menu as described on pg.136.
2. Press “Calibration/BUMP Setting”.

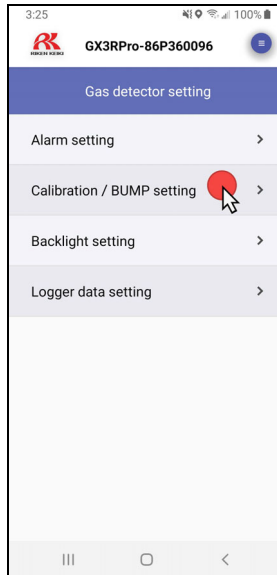

3. Turn the calibration and bump test reminder screens on or off with the toggle buttons. Set the calibration and bump test intervals.

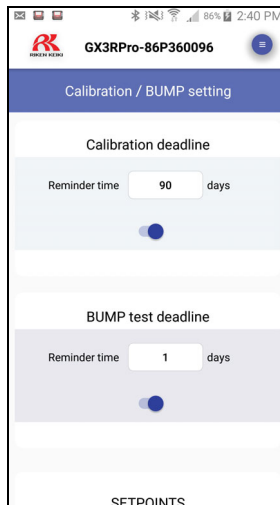

4. Scroll down to view or change the auto calibration value for each channel.

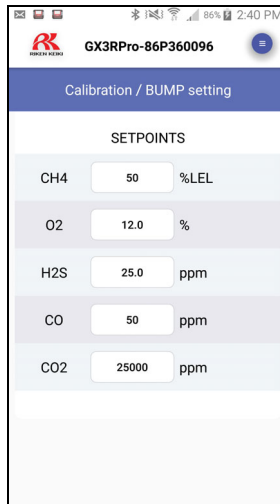

Backlight Setting

1. Access the Gas Detector Setting Menu as described on pg.136.
2. Press “Backlight setting”.

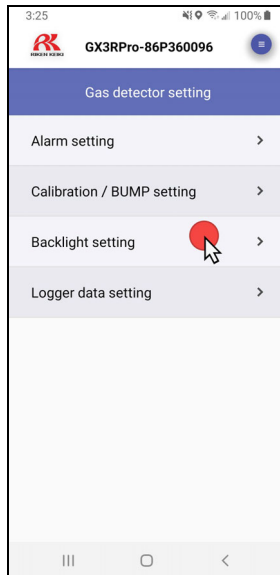

3. Set how long (in seconds) the backlight stays on after each button press. The options are 0-255 seconds. The factory setting is 30 seconds.

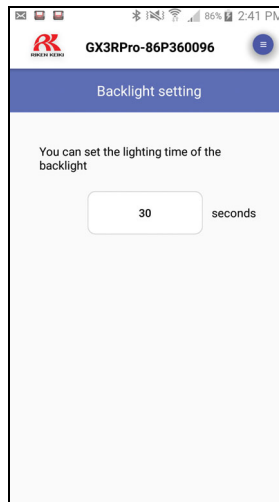

4. Press your phone's "Back" button.

Logger Data Settings

1. Access the Gas Detector Setting Menu as described on pg.136.
2. Press "Logger Data Setting".

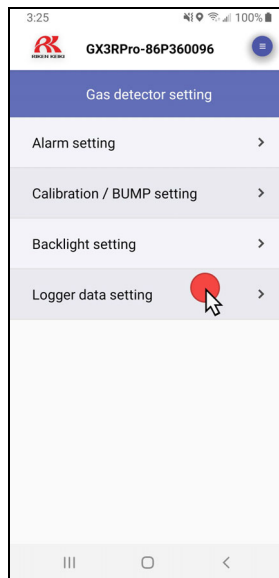

3. Set the interval trend time, Station ID, and User ID. The serial number is not editable.

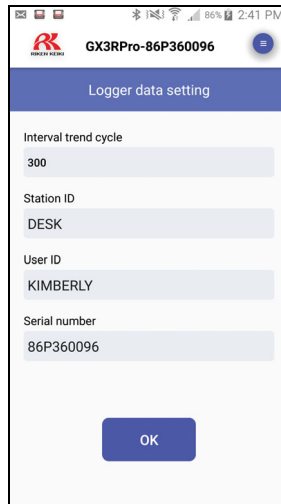

4. Press "Send". There is no confirmation that the information sent.

Viewing Serial Number, IDs, and Bump/Cal Information

Serial number, ID, and bump/cal information can only be viewed when a GX-3R Pro is paired with the app.

1. Press the  button in the upper right corner of the app.

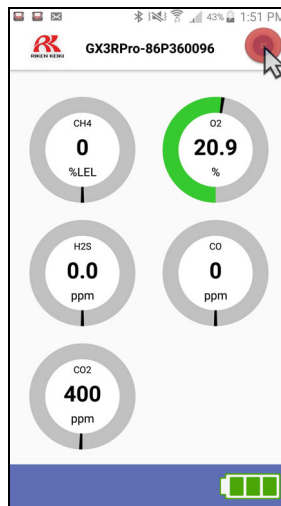

2. Press “Detector information”.

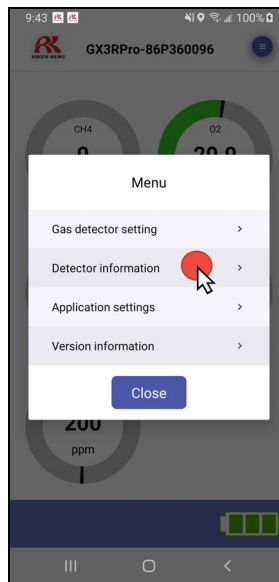

3. Detector information appears.



4. To view information for the last successful calibration and bump test, press the “Calibration BUMP history” button.



5. The instrument's serial number, station ID, user ID, and part of the calibration information appear.

The screenshot shows the 'Calibration · BUMP history' screen. Under 'Detector information', the following details are visible:

- Serial number: 86P360096
- Station ID: DESK
- User ID: KIMBERLY

The 'Calibration history' table shows the following data:

	Calibration date / time	Before calibration	After calibration	Calibration concentration	Calibration interval
CH4 100%LEL	2019 03/22 10:14:44	52	50	50	76
	2019 03/22 10:14:44	11.9	12.0	12.0	76
O2 40.0%	2019 03/22 10:14:44				

6. Scroll down to view the complete calibration information and/or the bump test information.

The screenshot shows the 'Calibration history' table with the following data:

	Calibration date / time	Before calibration	After calibration	Calibration concentration	Calibration interval
CH4 100%LEL	2019 03/22 10:14:44	52	50	50	76
	2019 03/22 10:14:44	11.9	12.0	12.0	76
H2S 200.0ppm	2019 03/22 10:14:44	41.5	25.0	25.0	76
CO 2000ppm	2019 03/22 10:14:44	51	50	50	76
CO2 10000ppm	2018 10/15 11:19:09	26200	25000	25000	Now

Viewing App Version Info

App version information can be viewed with or without a GX-3R Pro paired with the app.

1. Press the  button in the upper right corner of the app.

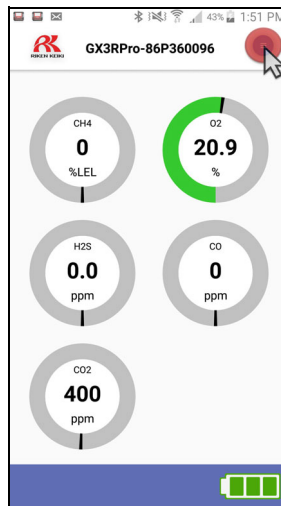

2. Press “Version information”.

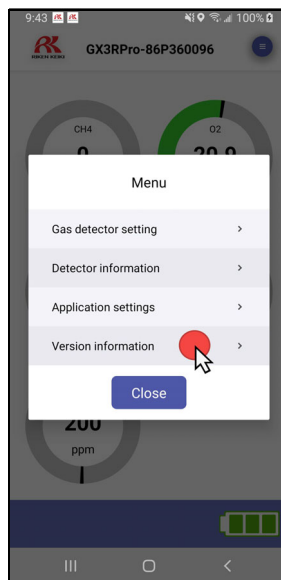

3 . Instrument information and app information appear.

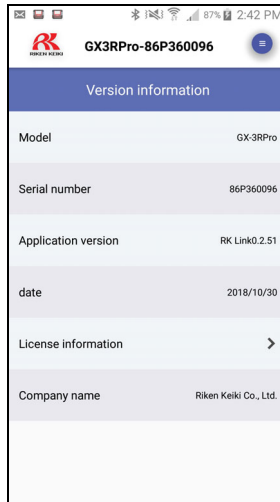

4 . To view the license information, press “License information”.

Appendix B: Maintenance Mode

Overview

This appendix describes the GX-3R Pro in Maintenance Mode. The GX-3R Pro is factory-set to suit most applications. Update settings in Maintenance Mode only if required for your specific application. Maintenance Mode items and their factory settings are listed in Table 20 below.

Table 20: Maintenance Mode Menu Items

Maintenance Mode Menu Item	Description	
GAS CAL (pg.150)	Perform an air adjust, perform a span adjustment, change the calibration values, set the cylinder group.	
	AIR CAL	Perform a fresh air adjustment.
	CO2 ZERO CAL*	Perform a zero adjustment on the CO ₂ channel using 100% nitrogen.
	AUTO CAL	Perform a span adjustment, set the calibration gas concentration, and set the cylinder for each gas.
	AUTO CAL CYL X	Perform an automatic span adjustment on the gases selected for Cylinder X.
	START MEASURE	Begin the warmup sequence and enter Measuring Mode.
	SETTING CAL-P	Set the calibration gas concentration for each gas.
	CYL SETTING	Assign a cylinder (A-E) to each gas. Multiple gases can be assigned to the same cylinder.
ESCAPE	Return to the AUTO CAL menu item.	
ESCAPE	Return to the GAS CAL menu item.	
GAS TEST (pg.151)	Apply gas to test sensor response and observe alarm indications without an alarm event being recorded.	
SENSOR DATE (pg.152)	View the replacement date for each sensor and the battery and/or set the replacement date for each sensor or the battery to the current date.	
BUMP TEST (pg.153)	Perform a bump test.	
	BUMP TEST CYL X	Perform a bump test on the gases selected for Cylinder X (A-E cylinders available).
	START MEASURE	Begin the warmup sequence and enter Measuring Mode.
	ESCAPE	Return to BUMP TEST menu item.

Table 20: Maintenance Mode Menu Items

Maintenance Mode Menu Item	Description
LATCHING (pg.154)	ON (factory setting): The GX-3R Pro remains in alarm until the alarm condition passes <i>and</i> POWER MODE is pressed. OFF: The GX-3R Pro automatically resets an alarm when the alarm condition passes.
DEMAND ZERO (pg.154)	ON (factory setting): You can manually perform a fresh air adjust in Measuring Mode by pressing AIR. OFF: You cannot manually perform a fresh air adjust in Measuring Mode by pressing AIR.
AUTO ZERO (pg.155)	ON: The GX-3R Pro asks if you want to perform a fresh air adjustment at the end of the startup sequence. OFF (factory setting): The GX-3R Pro does not ask if you want to perform a fresh air adjustment at the end of the startup sequence.
ID DISPLAY (pg.155)	ON: User ID and Station ID screens appear in startup sequence. IDs can be changed in Display Mode. IDs can be edited in Display Mode if D MODE SETTING in User Mode is also set to ON . OFF (factory setting): User ID and Station ID screens do not appear in startup sequence. IDs cannot be changed in Display Mode.
ZERO SUPPRESS (pg.156)	ON (factory setting): Not intended for field adjustment. The suppression values are: Combustible gas: 2% LEL O ₂ : 0.5% volume H ₂ S: 0.3 ppm CO: 2 ppm CO ₂ : 0 ppm HCN: 0.5 ppm NH ₃ : 4 ppm NO ₂ : 0.30 ppm PH ₃ : 0.02 ppm SO ₂ : 0.20 ppm
ZERO FOLLOWER (pg.156)	Not intended for field adjustment. Oxygen channel does not support zero follower functionality. Factory setting for all other channels is ON .
DISP ZERO SUP (pg.156)	ON (factory setting): Zero suppression menu item appears in User Mode. OFF: Zero suppression menu item does not appear in User Mode. (Zero suppression menu item is always available in Maintenance Mode)
DISP ZERO FLWR (pg.156)	ON: Zero follower menu item appears in User Mode. OFF (factory setting): Zero follower menu item does not appear in User Mode. (Zero follower menu item is always available in Maintenance Mode)
DATE (pg.157)	Set the current date and time.
DATE FORMAT (pg.157)	MM/DD/YYYY (factory setting): month/day/year YYYY/MM/DD: year/month/day DD/MM/YYYY: day/month/year
LANGUAGE (pg.158)	Set the instrument language. Options: English (factory setting), Japanese, Italian, Spanish, German, French, Portuguese, Russian, Korean, Chinese (TC)

Table 20: Maintenance Mode Menu Items

Maintenance Mode Menu Item	Description
MAINT PASSWORD (pg.158)	ON (factory setting): Maintenance Mode is password-protected. Factory-set password is 8102 . OFF: Maintenance Mode is not password-protected.
ROM/SUM (pg.159)	View the firmware information for the GX-3R Pro’s sensor board(s), main board, gas list, and view the Bluetooth version.
LCD CONTRAST (pg.160)	1-50 (factory setting 20)
M.DEFAULT (pg.160)	Set all parameters back to their RKI factory settings.
START MEASURE (pg.161)	Press and release POWER MODE to begin the warmup sequence and enter Measuring Mode.
* Only appears in units with a CO ₂ sensor installed.	

Entering Maintenance Mode

WARNING: *The GX-3R Pro is not in operation as a gas detector while in Maintenance Mode.*

1. Take the GX-3R Pro to a non-hazardous location and turn it off if it is on.
2. Press and hold AIR, then press and hold POWER MODE. You will hear a beep after one second. Continue to hold the buttons down.
3. When you hear a second beep, release the buttons.
4. The screen that appears depends on the setting of Maintenance Mode’s **MAINT PASSWORD** item.

If **MAINT PASSWORD** is set to **OFF**, continue with Step 7.

If **MAINT PASSWORD** is set to **ON** (factory setting), continue with Step 5.

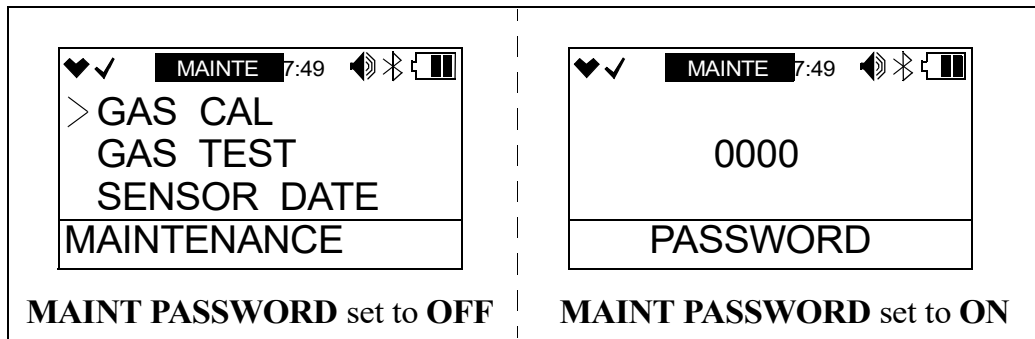

5. If **MAINT PASSWORD** is set to **ON** in Maintenance Mode, a password screen appears. The first digit is flashing. The factory-set password is **8102** but it can be changed as desired.

6. Use AIR to select each password number then press POWER MODE to save it and move on to the next number. To go back a number, press and hold AIR and POWER MODE for a few seconds. To reverse the direction of change (ie. from increasing to decreasing or vice versa):
 - a. Press and hold AIR.
 - b. Immediately press POWER MODE and then release both buttons.
7. The Maintenance Mode menu displays.



8. **MAINTE** at the top of the screen indicates that the GX-3R is in Maintenance Mode.
9. Use AIR to move through the Maintenance Mode menu items.

Tips for Using Maintenance Mode

- To scroll from one menu item to the next, press and release AIR. To reverse the scrolling direction:
 - a. Press and hold AIR.
 - b. Immediately press POWER/MODE and then release both buttons.
 - c. The scrolling direction returns to the original direction when you exit and reenter a menu.
- To skip an item when a question is asked, press and release AIR.
- To enter an item and to save any changes, press and release POWER MODE.
- To change a flashing parameter, press and release AIR. To reverse the direction of change (ie. from increasing to decreasing or vice versa):
 - a. Press and hold AIR.
 - b. Immediately press POWER MODE and then release both buttons.
- To exit an entered menu item without saving a change, press and hold AIR and POWER MODE for a few seconds.

Performing a Calibration (GAS CAL)

See “Performing a Calibration (GAS CAL)” on page 62 for instructions.

Performing a Gas Test (GAS TEST)

The **GAS TEST** menu item allows you to apply gas to the instrument and see all alarm indications except for the buzzer indication. There is no buzzer indication in the **GAS TEST** menu even though the buzzer sounds in the event of a real gas alarm condition while in Measuring Mode.

Preparing for a Gas Test

To perform a gas test on the GX-3R, you will need:

- A calibration cylinder. The concentrations should be above the alarm condition you want to check. Standard alarm points are listed on pg.8.
 - 0.25 LPM fixed flow regulator
 - Non-absorbent tubing
 - Calibration cup
1. Install the calibration cup onto the GX-3R Pro. Use the label and imprinting to make sure that the calibration cup gets installed in the correct orientation relative to the GX-3R Pro. Be sure the calibration cup is pushed on all the way.

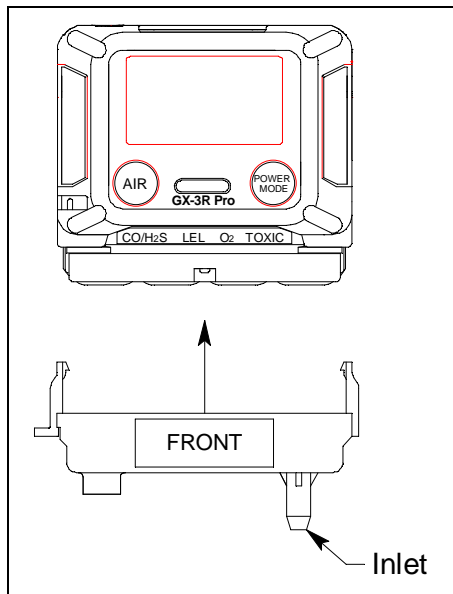
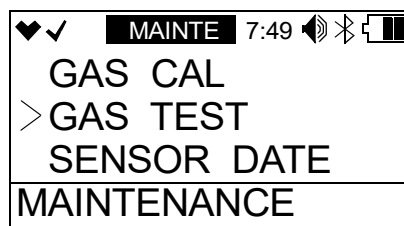

Figure 28: Calibration Cup Installation

2. Use the tubing to connect the regulator to the inlet of the calibration cup.

Performing a Gas Test

1. While in Maintenance Mode, use AIR to place the cursor next to **GAS TEST**.



- Press and release POWER MODE. The current gas readings display. The bottom of the LCD indicates “GAS TEST” and “BUZZER OFF”.

♥✓		7:49		🔊 🔌 🔋	
CH4	%LEL	CO	ppm	H2S	ppm
	0		0		0.0
O2	%	CO2	vol%		
	20.9		0.0		
GAS TEST			BUZZER OFF		

- For toxic gas cylinders (like cylinders containing H₂S), it is important to vent the regulator while installing it onto the cylinder. Venting the regulator during installation helps prevent air from getting into the cylinder and degrading the gas. Open the regulator by turning the knob counterclockwise and install it onto the cylinder.
- The instrument initiates alarm indications except for the buzzer. There is no buzzer indication in the **GAS TEST** menu even though the buzzer sounds in the event of a real gas alarm condition.
- Turn the regulator knob clockwise to close the regulator.
- Unscrew the regulator from the calibration cylinder.
- Remove the calibration cup from the GX-3R Pro.
- Store the calibration kit in a safe and convenient place.
- Press and release POWER MODE to return to Maintenance Mode.
- See “Exiting Maintenance Mode (START MEASURE)” on page 161 to return to Measuring Mode.

Sensor/Battery Replacement Date (SENSOR DATE)

The **SEN DATE** menu item allows you to keep track of when the sensors and the battery were replaced.

- While in Maintenance Mode, use AIR to place the cursor next to **SENSOR DATE**.

♥✓	MAINTE	7:49	🔊 🔌 🔋
GAS TEST			
> SENSOR DATE			
BUMP TEST			
MAINTENANCE			

- Press and release POWER MODE. The combustible gas sensor’s replacement date appears.

♥✓	MAINTE	7:49	🔊 🔌 🔋
CH4			
MM/DD/YYYY			
10/12/2018			
SENSOR DATE			

3. Use AIR to scroll to the item whose replacement date you want to view or change.

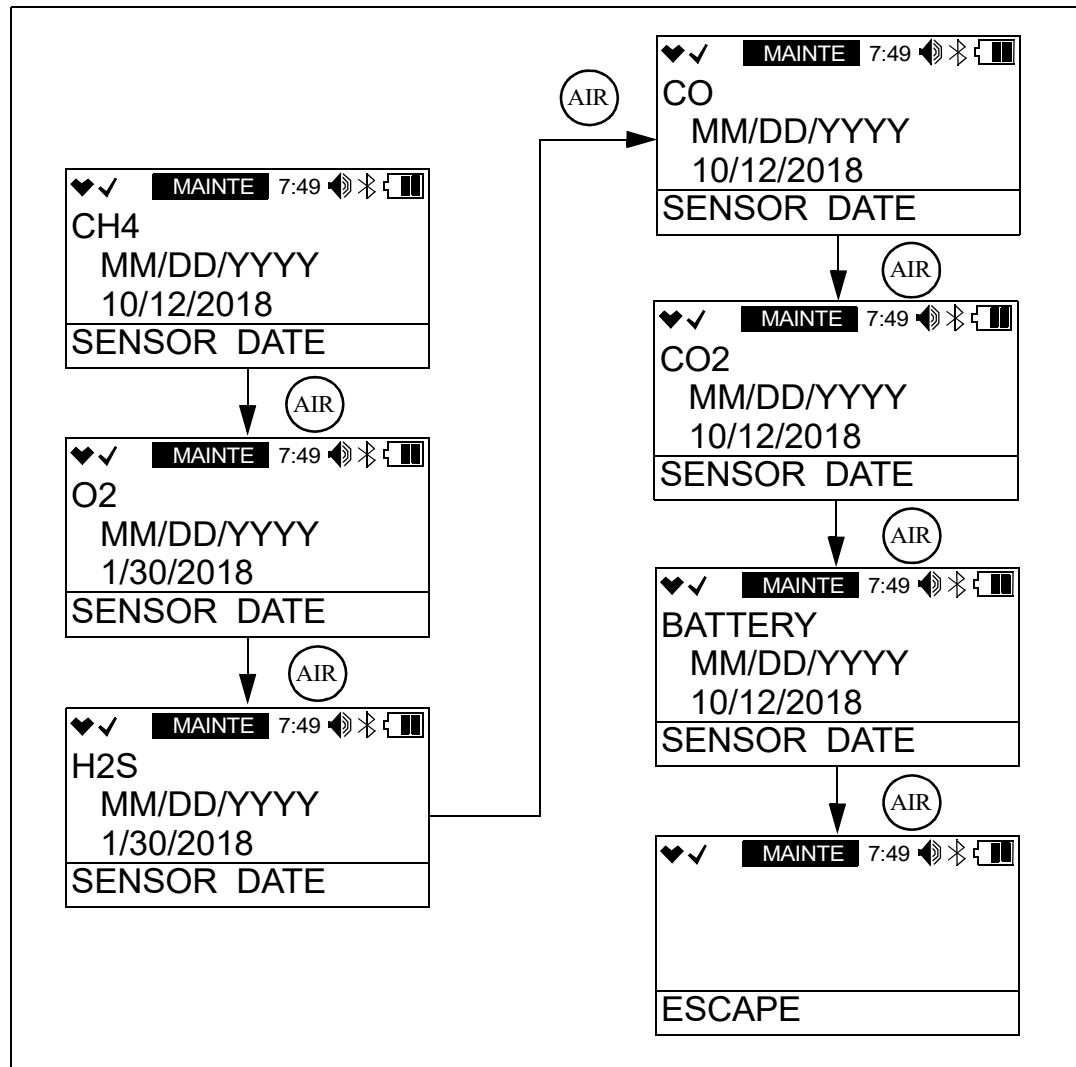

4. To change the replacement date:
 - a. With the desired item displayed, press and release POWER MODE.
 - b. Press and release POWER MODE again to set the replacement date to the current date.
5. Use the AIR button to scroll to the **ESCAPE** menu item.
6. Press and release POWER MODE to return to Maintenance Mode.
7. See “Exiting Maintenance Mode (START MEASURE)” on page 161 to return to Measuring Mode.

Performing a Bump Test (BUMP TEST)

See “Performing a Bump Test (BUMP TEST)” on page 56 for instructions.

Setting Alarms to Latching or Self-Resetting (LATCHING)

ON (factory setting): The GX-3R Pro remains in alarm until the alarm condition passes *and* POWER MODE is pressed.

OFF: The GX-3R Pro automatically resets an alarm when the alarm condition passes.

1. While in Maintenance Mode, use AIR to place the cursor next to **LATCHING**.



2. Press and release POWER MODE. The current setting flashes.
3. Use AIR to display the desired setting.
4. Press and release POWER MODE to save the setting and return to Maintenance Mode.
5. See “Exiting Maintenance Mode (START MEASURE)” on page 161 to return to Measuring Mode.

Turning Demand Zero On/Off (DEMAND ZERO)

ON (factory setting): You can manually perform a fresh air adjust in Measuring Mode by pressing AIR.

OFF: You cannot manually perform a fresh air adjust in Measuring Mode.

1. While in Maintenance Mode, use AIR to place the cursor next to **DEMAND ZERO**.

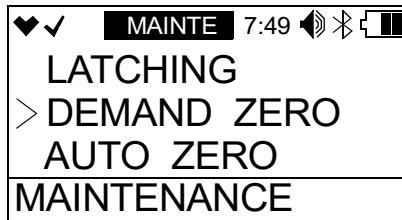

2. Press and release POWER MODE. The current setting flashes.
3. Use AIR to display the desired setting.
4. Press and release POWER MODE to save the setting and return to Maintenance Mode.
5. See “Exiting Maintenance Mode (START MEASURE)” on page 161 to return to Measuring Mode.

Turning Auto Zero On/Off (AUTO ZERO)

ON: The GX-3R Pro asks if you want to perform a fresh air adjustment at the end of the startup sequence.

OFF (factory setting): The GX-3R Pro does not ask if you want to perform a fresh air adjustment at the end of the startup sequence.

1. While in Maintenance Mode, use AIR to place the cursor next to **AUTO ZERO**.



2. Press and release POWER MODE. The current setting flashes.
3. Use AIR to display the desired setting.
4. Press and release POWER MODE to save the setting and return to Maintenance Mode.
5. See “Exiting Maintenance Mode (START MEASURE)” on page 161 to return to Measuring Mode.

Turning ID Display Function On/Off (ID DISPLAY)

ON: The User ID and Station ID screens appear in startup sequence. If **D MODE SETTING** in User Mode is also set to **ON**, then the IDs can be changed in Display Mode.

OFF (factory setting): The User ID and Station ID screens do not appear in startup sequence and the IDs cannot be changed in Display Mode.

1. While in Maintenance Mode, use AIR to place the cursor next to **ID DISPLAY**.

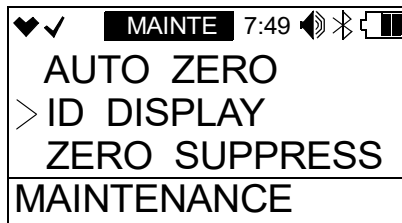

2. Press and release POWER MODE. The current setting flashes.
3. Use AIR to display the desired setting.
4. Press and release POWER MODE to save the setting and return to Maintenance Mode.
5. See “Exiting Maintenance Mode (START MEASURE)” on page 161 to return to Measuring Mode.

Turning Zero Suppression On/Off (ZERO SUPPRESS)

The **ZERO SUPPRESS** setting is not intended for field adjustment. The default setting for each sensor is **ON**.

Sensor	Zero Suppression Value
Combustible Gas	2% LEL
O ₂	0.5% volume
H ₂ S	0.3 ppm
CO	2 ppm
CO ₂	0 ppm
HCN	0.5 ppm
NH ₃	4 ppm
NO ₂	0.30 ppm
PH ₃	0.02 ppm
SO ₂	0.20 ppm

Turning Zero Follower On/Off (ZERO FOLLOWER)

The **ZERO FOLLOWER** setting is not intended for field adjustment. The oxygen channel does not support zero follower functionality. The default setting is **ON** for all other channels.

User Mode Zero Suppression (DISP ZERO SUP)

ON (factory setting): Zero suppression menu item appears in User Mode.

OFF: Zero suppression menu item does not appear in User Mode. Zero suppression menu item is always available in Maintenance Mode.

User Mode Zero Follower (DISP ZERO FLWR)

ON: Zero follower menu item appears in User Mode.

OFF (factory setting): Zero follower menu item does not appear in User Mode. Zero follower menu item is always available in Maintenance Mode.

It is not normally necessary to have the zero follower menu item appear in User Mode. Contact RKI Instruments before turning this setting on.

Setting the Date/Time (DATE)

1. While in Maintenance Mode, use AIR to place the cursor next to **DATE**.

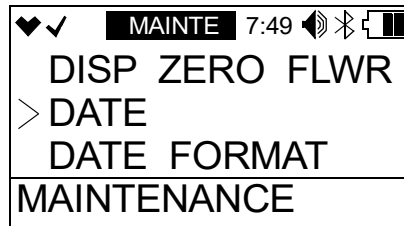

2. Press and release POWER MODE. The date and time appear and the year flashes.

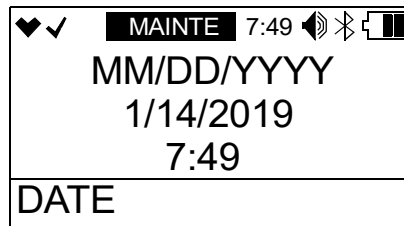

3. Use AIR to display the desired year.
4. Press and release POWER MODE to save the setting. The month setting flashes.
5. Repeat Step 3 and Step 4 to enter the month, day, hours, and minutes settings. The date and time are saved and the instrument returns to Maintenance Mode.
6. See “Exiting Maintenance Mode (START MEASURE)” on page 161 to return to Measuring Mode.

Setting the Date Format (DATE FORMAT)

MM/DD/YYYY (factory setting): month/day/year.

YYYY/MM/DD: year, month, day.

DD/MM/YYYY: day, month, year.

1. While in Maintenance Mode, use AIR to place the cursor next to **DATE FORMAT**.



2. Press and release POWER MODE. The current setting flashes.
3. Use AIR to display the desired setting.
4. Press and release POWER MODE to save the setting and return to Maintenance Mode.
5. See “Exiting Maintenance Mode (START MEASURE)” on page 161 to return to Measuring Mode.

Setting the Instrument Language (LANGUAGE)

English (factory setting), Japanese, Italian, Spanish, German, French, Portuguese, Russian, Korean, Chinese (TC)

1. While in Maintenance Mode, use AIR to place the cursor next to **LANGUAGE**.

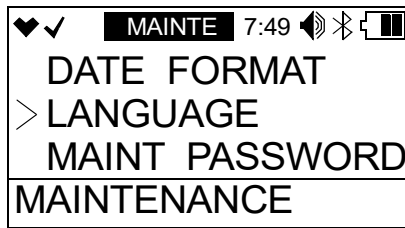

2. Press and release POWER MODE. The current setting flashes.
3. Use AIR to display the desired setting.
4. Press and release POWER MODE to save the setting and return to Maintenance Mode.
5. See “Exiting Maintenance Mode (START MEASURE)” on page 161 to return to Measuring Mode.

Turning the Password On/Off (MAINT PASSWORD)

ON (factory setting): The GX-3R Pro prompts you for a password when you enter Maintenance Mode. The factory-set password is **8102** but can be changed as desired.

OFF: No password is required to enter Maintenance Mode.

1. While in Maintenance Mode, use AIR to place the cursor next to **PASSWORD**.

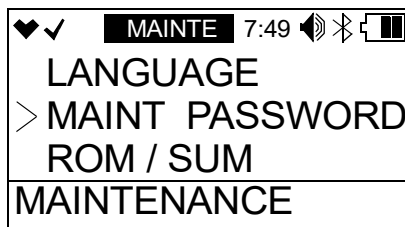

2. Press and release POWER MODE. The current setting flashes.
3. Use AIR to display the desired setting.
4. If you selected **OFF**, press and release POWER MODE to save the setting and return to Maintenance Mode.

If you selected **ON**, continue with Step 5.

5. Press and release POWER MODE. The Set Password Screen appears. The current password appears and the first digit flashes.

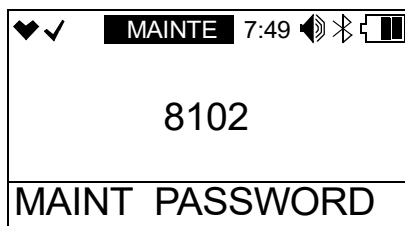

6. Use AIR to display a number from 0 to 9.
7. Press and release POWER MODE to enter the selection and advance to the next number. To go back a number, press and hold AIR and POWER MODE for a few seconds.

8. Repeat Step 6 and Step 7 to select the remaining numbers. When you press and release POWER MODE to enter the last number, the password is saved and the instrument returns to Maintenance Mode.
9. See “Exiting Maintenance Mode (START MEASURE)” on page 161 to return to Measuring Mode.

Viewing the ROM/SUM (ROM/SUM)

The **ROM/SUM** screen shows the instrument’s firmware version and the firmware checksum.

1. While in Maintenance Mode, use AIR to place the cursor next to **ROM/SUM**.



2. Press and release POWER MODE. The screen cycles through the main board’s ROM/SUM, the sensor board’s ROM/SUM, the Bluetooth version, the IR sensor’s ROM/SUM (if an IR sensor is installed), and the gas list’s ROM/SUM. The ROM is the top value and the SUM is the bottom value.

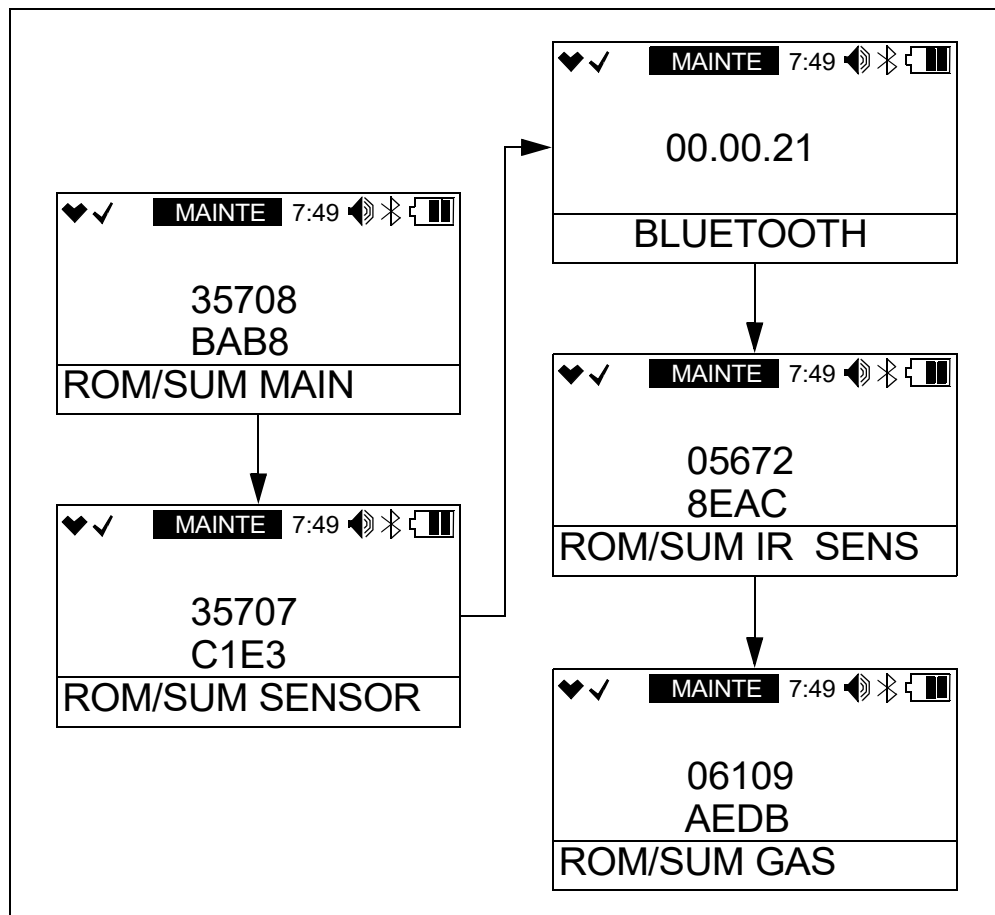

3. Press and release POWER MODE to return to the **ROM/SUM** menu item in Maintenance Mode.
4. See “Exiting Maintenance Mode (START MEASURE)” on page 161 to return to Measuring Mode.

Adjusting the LCD's Contrast (LCD CONTRAST)

Higher number means darker background. Lower number means lighter background. **1-50. 20** is factory setting.

1. While in Maintenance Mode, use AIR to place the cursor next to **LCD CONTRAST**.



2. Press and release POWER MODE. The current setting flashes.
3. Use AIR to display the desired setting.
4. Press and release POWER MODE to save the setting and return to Maintenance Mode.
5. See “Exiting Maintenance Mode (START MEASURE)” on page 161 to return to Measuring Mode.

Performing a Default (M.DEFAULT)

Performing a default operation in Maintenance Mode returns all parameters to their RKI factory settings.

1. While in Maintenance Mode, use AIR to place the cursor next to **M.DEFAULT**.

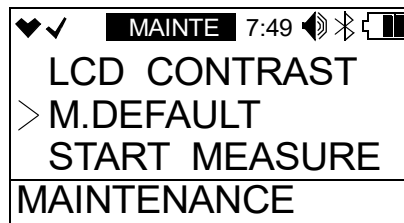

2. Press and release POWER MODE. The instrument asks if you want to restore all defaults.

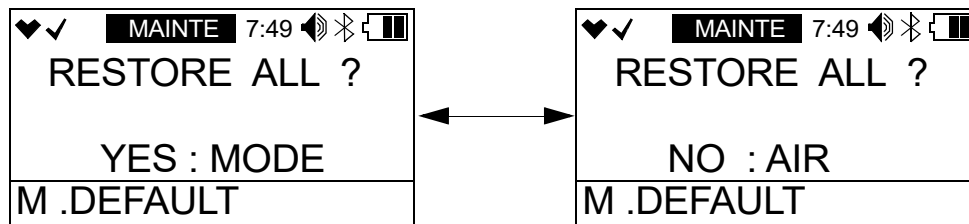

3. Press and release POWER MODE to continue. Press and release AIR to return to Maintenance Mode.
4. The instrument asks if you are sure you want to restore the defaults.

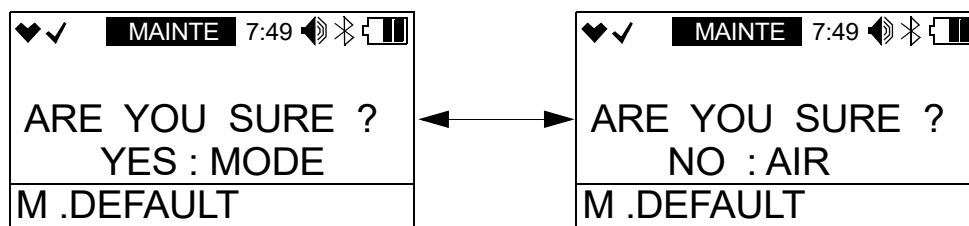

5. Press and release POWER MODE to perform the default operation. Press and release AIR to return to Maintenance Mode.
6. The instrument beeps twice and returns to Maintenance Mode.
7. See “Exiting Maintenance Mode (START MEASURE)” on page 161 to return to Measuring Mode.

Exiting Maintenance Mode (START MEASURE)

1. While in Maintenance Mode, use AIR to place the cursor next to **START MEASURE**.

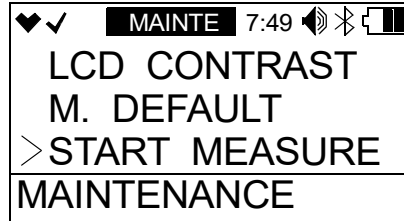

2. Press and release POWER MODE.
3. The instrument begins its start-up sequence.

Appendix C: Gas Select Mode

Overview

This appendix describes the GX-3R Pro in Gas Select Mode. The GX-3R Pro is factory-set to suit most applications. Update settings in Gas Select Mode only if required for your specific application. A description of the Gas Select Mode items is shown in Table 21 below.

Table 21: Gas Select Mode Menu Items

Menu Item (Page # of Description)	Description
GAS COMBO (pg.164)	Turn channels on or off and change target gas for each channel.
SAVE ALARM-P (pg.166)	Set the current alarm points as the default alarm points.
DISP MAX SPAN (pg.166)	ON : Maximum span screen appears after a successful calibration. OFF (factory setting) : No maximum span screen appears.
STEALTH (pg.167)	STEALTH ON : No backlight, LED, or buzzer operation. STEALTH OFF (factory setting) : Backlight, LED, and buzzer operate normally. <i>This setting has no effect unless STEALTH is set to ON.</i> VIBRATION ON : Vibrator activates for alarm conditions. VIBRATION OFF (factory setting) : Vibrator does not activate in any situation.
CHANGE LEL (pg.168)	STANDARD (factory setting) : Apply standard settings for lower explosive limit's ppm level. IEC : Apply IEC settings for lower explosive limit's ppm level. ISO : Apply ISO settings for lower explosive limit's ppm level.
START MEASURE (pg.169)	Enter Measuring Mode

Entering Gas Select Mode

WARNING: *The GX-3R Pro is not in operation as a gas detector while in Gas Select Mode.*

1. Take the GX-3R Pro to a non-hazardous location and turn it off if it is on.
2. Press and hold AIR, then press and hold POWER MODE. You will hear a beep after one second. Continue to hold the buttons down.
3. You will hear a second beep. Continue to hold the buttons down.
4. When you hear a third beep, release the buttons.

5. The password screen appears. The first digit is flashing. The password is **2014**.



6. Use AIR to select each password number then press POWER MODE to save it and move on to the next number. To go back a number, press and hold AIR and POWER MODE for a few seconds. To reverse the direction of change (ie. from increasing to decreasing or vice versa):
- Press and hold AIR.
 - Immediately press POWER MODE and then release both buttons.
7. The Gas Select Mode menu appears.

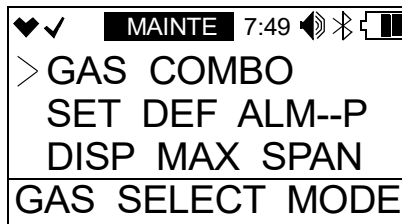

8. **MAINT** at the top of the screen indicates that the GX-3R is in Gas Select Mode.
9. Use AIR to move through the Gas Select Mode menu items.

Tips for Using Gas Select Mode

- To scroll from one menu item to the next, press and release AIR. To reverse the scrolling direction:
 - Press and hold AIR.
 - Immediately press POWER/MODE and then release both buttons.
 - The scrolling direction returns to the original direction when you exit and reenter a menu.
- To skip an item when a question is asked, press and release AIR.
- To enter an item and to save any changes, press and release POWER MODE.
- To change a flashing parameter, press and release AIR. To reverse the direction of change (ie. from increasing to decreasing or vice versa):
 - Press and hold AIR.
 - Immediately press POWER MODE and then release both buttons.
- To exit an entered menu item without saving a change, press and hold AIR and POWER MODE for a few seconds.

Changing the Gas Combination (GAS COMBO)

The **GAS COMBO** menu item allows you to turn channels on and off and change each channel's target gas.

If you want the combustible gas channel to be calibrated to a specific target gas, select that target gas here and then calibrate to it in User Mode (see pg.62).

1. While in Gas Select Mode, use AIR to place the cursor next to **GAS COMBO**.



2. Press and release POWER MODE. The first channel appears.

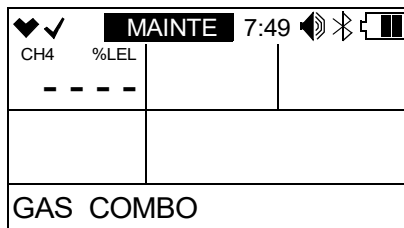

3. Press AIR to scroll to the instrument channel whose target gas you want to change.

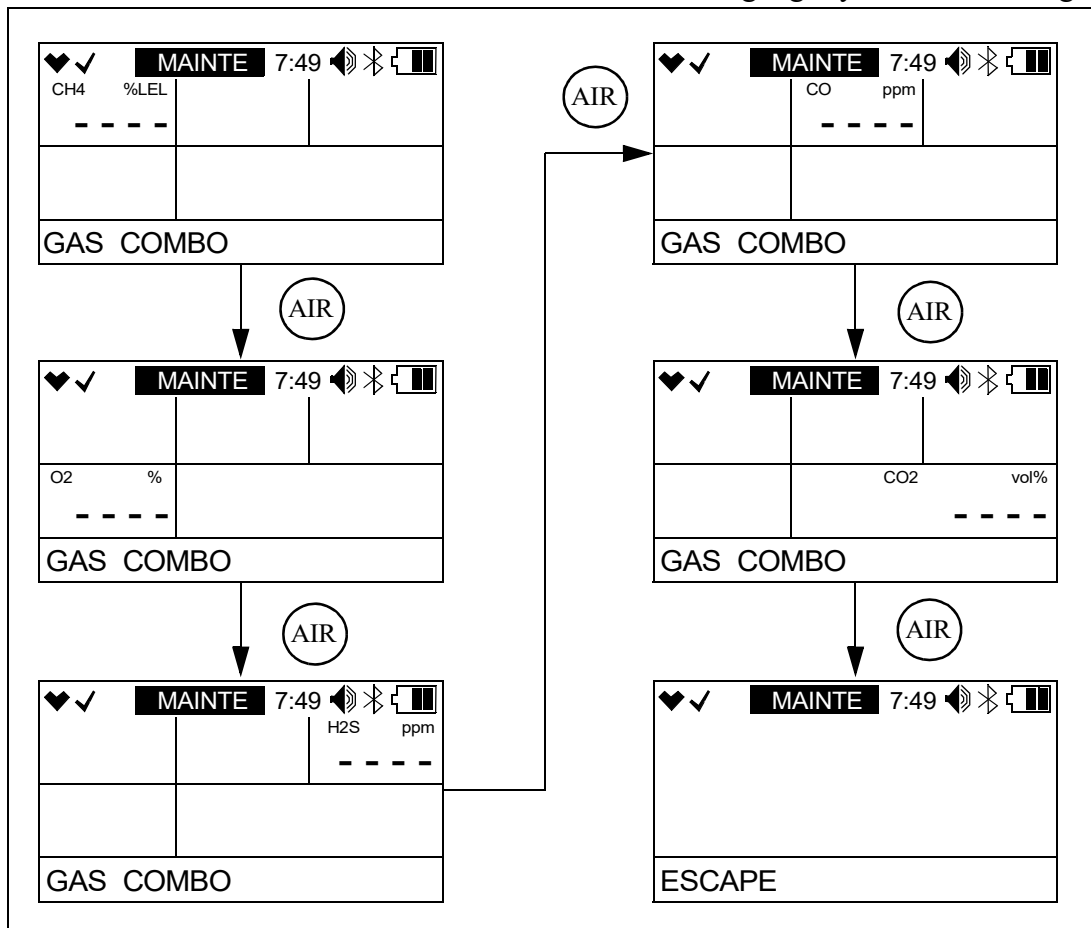

4. Press and release POWER MODE.
5. The target gas for the channel appears.

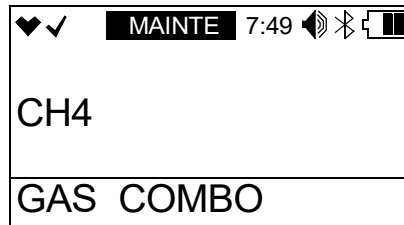

6. Use AIR to change the target gas or turn the channel off.

Table 22: Target Gas Options for Each Channel

Channel	Target Gas Options
Combustible Gas	<ul style="list-style-type: none"> • CH4 (methane) • i-C4H10 (isobutane) • H2 (hydrogen) • CH3OH (methanol) • C2H2 (acetylene) • C2H4 (ethylene) • C2H6 (ethane) • C2H5OH (ethanol) • C3H6 (propylene) • C3H6O (acetone) • C3H8 (propane) • C4H6 (butyne) • C5H10 (cyclopentane) • C6H6 (benzene) • n-C6H14 (hexane) • C7H8 (toluene) • n-C7H16 (heptane) • C8H10 (xylene) • n-C9H20 (nonane) • EtAc (ethyl acetate) • IPA (isopropyl alcohol) • MEK (methyl ethyl ketone) • MMA (methyl methacrylate) • DME (dimethyl ether) • MIBK (methyl isobutyl ketone) • THF (tetrahydrofuran) • CH4_VOL (methane %volume)* • ----- (off)
O2	<ul style="list-style-type: none"> • O2 (oxygen) • ----- (off)
H2S	<ul style="list-style-type: none"> • H2S (hydrogen sulfide for dual CO/H₂S sensor) • H2S SINGLE (hydrogen sulfide for single-gas H₂S sensor) • H2_CO-H2 (hydrogen compensated CO) • ----- (off)
CO	<ul style="list-style-type: none"> • CO (carbon dioxide for dual CO/H₂S sensor or single-gas CO sensor) • SO2 (sulfur dioxide) • CO_CO-H2 (hydrogen compensated CO) • HCN (hydrogen cyanide) • ----- (off)
5th gas	<ul style="list-style-type: none"> • EXTRA (for CO2 sensors) • SO2 (sulfur dioxide) • H2S (hydrogen sulfide for single-gas H₂S sensor) • NH3 (ammonia) • NO2 (nitrogen dioxide) • HCN (hydrogen cyanide) • PH3 (phosphine) • ----- (off)
<p>* If CH4_VOL is selected, the CHANGE LEL item in Gas Select Mode has no effect on operation.</p>	

7. Press and release POWER MODE to save the setting.
8. Repeat Step 1 - Step 7 to change the target gas for other channels.
9. Use AIR to scroll to **ESCAPE**.
10. Press and release POWER MODE. The instrument returns to Gas Select Mode.
11. See “Exiting Gas Select Mode (START MEASURE)” on page 169 to return to Measuring Mode.

Saving the Alarm Points (SAVE ALARM-P)

Performing a **SAVE ALARM-P** operation saves the current alarm setpoints.

Performing a **DEFAULT ALM-P** operation in the **ALARM SETTING** User Mode menu item sets the instrument’s alarm points to those saved during the **SAVE ALARM-P** operation (if performed).

Performing a **SAVE ALARM-P** operation has no effect on an **M.DEFAULT** in Maintenance Mode. An **M.DEFAULT** operation returns all instrument settings to the RKI default regardless of if a **SAVE ALARM-P** operation was performed.

1. While in Gas Select Mode, use AIR to place the cursor next to **SAVE ALARM-P**.



2. Press and release POWER MODE. The display alternate between the following screens.

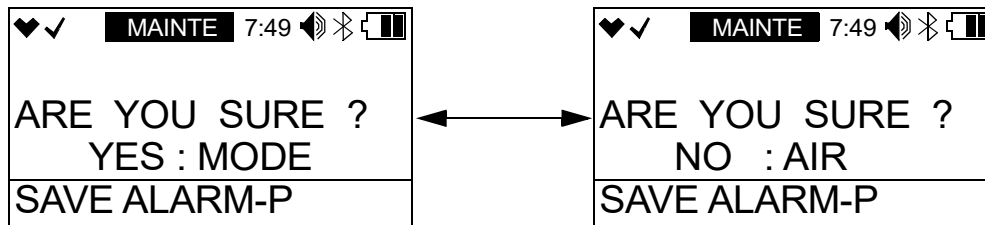

3. Press and release POWER MODE to save the current alarm point settings as the default.
4. The instrument returns to Gas Select Mode.
5. See “Exiting Gas Select Mode (START MEASURE)” on page 169 to return to Measuring Mode.

Turning the Calibration Max Span On/Off (DISP MAX SPAN)

ON: After a passed calibration, the GX-3R displays the maximum possible adjustment it could have made to the response reading. So if the combustible gas channel was calibrated with 50% LEL gas and the maximum indicated span is 95% LEL, this means that there was enough adjustment left on that channel to set the reading to 95% LEL when the detector was exposed to 50% LEL gas. If the maximum span value is close to the calibration gas value, for example if it is 53% LEL when exposed to 50% LEL gas, the sensor should be replaced soon. The upper limit on the maximum adjustment indicated for all channels except for oxygen is either twice the calibration value or full scale, whichever is lower. The upper limit on the maximum adjustment indicated for the oxygen channel is 25.0% volume.

OFF (factory setting): There is no maximum span indication at the end of a calibration.

1. While in Gas Select Mode, use AIR to place the cursor next to **DISP MAX SPAN**.



2. Press and release POWER MODE. The current setting flashes.
3. Use AIR to display the desired setting.
4. Press and release POWER MODE to save the setting and return to Gas Select Mode.
5. See “Exiting Gas Select Mode (START MEASURE)” on page 169 to return to Measuring Mode.

Stealth and Vibrator Settings (STEALTH)

STEALTH

ON:

- The instrument’s backlight does not come on, regardless of the **BACKLIGHT TIME** setting.
- The instrument’s LEDs do not come on for any reason, even alarm conditions.
- The instrument’s buzzer does not sound for any reason, even alarm conditions.
- An “S” appears at the top of the LCD.

OFF (factory setting): The instrument’s backlight and LEDs operate normally.

VIBRATION

*The **VIBRATION** setting only affects instrument operation if **STEALTH** is set to **ON**.*

ON: The vibrator activates for alarm conditions. It can be useful to have this feature turned on if you have also turned **STEALTH** on.

OFF (factory setting): The vibrator does not activate for any reason.

1. While in Gas Select Mode, use AIR to place the cursor next to **DISP MAX SPAN**.



2. Press and release POWER MODE. The current setting flashes.
3. Press and release POWER MODE. The current **STEALTH** setting flashes.
4. Use AIR to display the desired setting.
5. Press and release POWER MODE. The current **VIBRATION** setting flashes.
6. Use AIR to display the desired setting.
7. Press and release POWER MODE to save the setting and return to Gas Select Mode.
8. See “Exiting Gas Select Mode (START MEASURE)” on page 169 to return to Measuring Mode.

LEL Definition (CHANGE LEL)

The **CHANGE LEL** menu item defines what standard the instrument follows in determining the LEL (lower explosive limit) for the combustible channel's target gas.

STANDARD: Apply the standards settings for the lower explosive limit's ppm level.

IEC: Apply the IEC settings (per IEC 60079-20-1 2010[ed1.0]) for the lower explosive limit's ppm level.

ISO: Apply the ISO settings (per ISO 10156 2017) for the lower explosive limit's ppm level.

Table 23: Lower Explosive Limit ppm Levels

Gas	Standard (ppm)	IEC (ppm)	ISO (ppm)
Methane (CH ₄)	50,000	44,000	44,000
Isobutane (i-C ₄ H ₁₀)	18,000	13,000	15,000
Hydrogen (H ₂)	40,000	40,000	40,000
Methanol (CH ₃ OH)	55,000	60,000	60,000
Acetylene (C ₂ H ₂)	15,000	23,000	23,000
Ethylene (C ₂ H ₄)	27,000	23,000	24,000
Ethane (C ₂ H ₆)	30,000	24,000	24,000
Ethanol (C ₂ H ₅ OH)	33,000	31,000	31,000
Propylene (C ₃ H ₆)	20,000	20,000	18,000
Acetone (C ₃ H ₆ O)	21,500	25,000	25,000
Propane (C ₃ H ₈)	20,000	17,000	17,000
Butadiene (C ₄ H ₆)	11,000	14,000	14,000
Cyclopentane (C ₅ H ₁₀)	14,000	14,000	14,000*
Benzene (C ₆ H ₆)	12,000	12,000	12,000
N-hexane (n-C ₆ H ₁₄)	12,000	10,000	10,000
Toluene (C ₇ H ₈)	12,000	10,000	10,000
N-heptane (n-C ₇ H ₁₆)	11,000	8,500	8,000
Xylene (C ₈ H ₁₀)	10,000	10,000	10,000*
N-nonane (n-C ₉ H ₂₀)	7,000	7,000	7,000
Ethyl acetate (EtAc)	21,000	20,000	20,000
Isopropyl alcohol (IPA)	20,000	20,000	20,000*
Methyl ethyl ketone (MEK)	18,000	15,000	15,000
Methyl methacrylate (MMA)	17,000	17,000	17,000*
Dimethyl ether (DME)	30,000	27,000	27,000
Methyl isobutyl ketone (MIBK)	12,000	12,000	12,000*

Table 23: Lower Explosive Limit ppm Levels

Gas	Standard (ppm)	IEC (ppm)	ISO (ppm)
Tetrahydrofuran (THK)	20,000	15,000	15,000*
* Values are actually IEC because no ISO definition exists for these gases.			

1. While in Gas Select Mode, use AIR to place the cursor next to **CHANGE LEL**.



2. Press and release POWER MODE. The current setting flashes.
3. Use AIR to display the desired setting.
4. Press and release POWER MODE to save the setting and return to Gas Select Mode.
5. See “Exiting Gas Select Mode (START MEASURE)” on page 169 to return to Measuring Mode.

Exiting Gas Select Mode (START MEASURE)

1. From the main menu, place the cursor in front of **START MEASURE** at the bottom of the menu.



2. Press and release POWER MODE.
3. The unit begins its start-up sequence.

Appendix D: Interference Information

ESR-A13D-HCN, HCN Detection

Gas	Chemical Formula	Concentration	Indication Value
Acetone	C ₃ H ₆ O	5000 ppm	1.0 ppm
Acetylene	C ₂ H ₂	5 ppm	11.2 ppm
Ammonia	NH ₃	38.6 ppm	0.2 ppm
Carbon Dioxide	CO ₂	20.0 vol%	0.2 ppm
Carbon Monoxide	CO	100 ppm	0.3 ppm
Chlorine	Cl ₂	0.2 ppm	0.2 ppm
Ethane	C ₂ H ₆	1.6 vol%	0.0 ppm
Ethanol	C ₂ H ₅ OH	8333 ppm	-0.8 ppm* ¹
Hydrogen	H ₂	500 ppm	1.1 ppm
Hydrogen Sulfide	H ₂ S	25.0 ppm	0.2 ppm
Isobutane	i-C ₄ H ₁₀	0.72 vol%	12.3 ppm
Isopropyl Alcohol	C ₃ H ₈ O	5000 ppm	1.8 ppm* ¹
Methane	CH ₄	5.0 vol%	0.0 ppm
Methyl Ethyl Ketone	C ₄ H ₈ O	5000 ppm	0.6 ppm
Methyl Methacrylate	C ₅ H ₈ O ₂	4250 ppm	0.3 ppm
n-Hexane	n-C ₆ H ₁₄	3000 ppm	0.0 ppm
Nitrogen Dioxide	NO ₂	6.1 ppm	-28.9 ppm* ¹
Nitrogen Monoxide	NO	5.0 ppm	-12.7 ppm* ¹
Ozone	O ₃	0.45 ppm	-0.2 ppm
Phosphine	PH ₃	0.48 ppm	4.0 ppm
Propane	C ₃ H ₈	0.88 vol%	0.1 ppm
Propylene	C ₃ H ₆	0.7 vol%	34.6 ppm
Sulfur Dioxide	SO ₂	30.0 ppm	0.2 ppm
* ¹ The indicated value may fluctuate when exposed to this gas.			

ESR-A13D-NO2, NO₂ Detection

Gas	Chemical Formula	Concentration	Indication Value
Acetone	C ₃ H ₆ O	0.54 vol%	-0.24 ppm
Acetylene	C ₂ H ₂	100 ppm	-0.19 ppm
Ammonia	NH ₃	38.6 ppm	-0.02 ppm
Benzene	C ₆ H ₆	0.30 vol%	-0.73 ppm* ¹
Carbon Dioxide	CO ₂	20.0 vol%	-0.02 ppm
Carbon Monoxide	CO	99.9 ppm	-0.54 ppm
Chlorine	Cl ₂	2.0 ppm	-0.20 ppm
Cyclopentane	C ₅ H ₁₀	0.35 vol%	-0.03 ppm
Ethane	C ₂ H ₆	0.75 vol%	-0.02 ppm
Ethanol	C ₂ H ₅ OH	8333 ppm	-0.22 ppm* ¹
Ethyl Acetate	C ₄ H ₈ O ₂	0.53 vol%	-0.11 ppm
Fluorine	F ₂	1.6 ppm	-0.04 ppm
Hydrogen	H ₂	500 ppm	-0.80 ppm
Hydrogen Bromide	HBr	9.0 ppm	-0.04 ppm
Hydrogen Chloride	HCl	3.2 ppm	-0.06 ppm
Hydrogen Sulfide	H ₂ S	25.0 ppm	-0.09 ppm
Isobutane	i-C ₄ H ₁₀	0.45 vol%	-0.05 ppm
Isobuten	C ₄ H ₈	1000 ppm	-27.14 ppm
Isopropyl Alcohol	C ₃ H ₈ O	0.50 vol%	-0.63 ppm
Methane	CH ₄	1.26 vol%	-0.09 ppm
Methanol	CH ₃ OH	1.38 vol%	-2.32 ppm* ¹
Methyl Ethyl Ketone	C ₄ H ₈ O	0.45 vol%	-1.09 ppm
Methyl Isobutyl Ketone	C ₆ H ₁₂ O	0.30 vol%	-0.20 ppm
Methyl Methacrylate	C ₅ H ₈ O ₂	4250 ppm	-0.13 ppm
n-Hexane	n-C ₆ H ₁₄	0.30 vol%	-0.02 ppm
Nitrogen Monoxide	NO	99.2 ppm	-3.12 ppm

Gas	Chemical Formula	Concentration	Indication Value
Nonane	n-C ₉ H ₂₀	0.18 vol%	-0.01 ppm
Ozone	O ₃	0.48 ppm	0.30 ppm
Phosphine	PH ₃	2.51 ppm	-0.02 ppm
Propane	C ₃ H ₈	0.49 vol%	-0.01 ppm
Propylene	C ₃ H ₆	0.5 vol%	-48.27 ppm
Sulfur Dioxide	SO ₂	5 ppm	-4.99 ppm
Tetrahydrofuran	C ₄ H ₈ O	0.50 vol%	-0.90 ppm ^{*1}
Toluene	C ₇ H ₈	1.0 vol%	-0.46 ppm ^{*1}
Xylene	C ₈ H ₁₀	1.0 vol%	-0.12 ppm ^{*1}
* ¹ The indicated value may fluctuate when exposed to this gas.			

ESR-A13D-PH3, PH₃ Detection

Gas	Chemical Formula	Concentration	Indication Value
Acetone	C ₃ H ₆ O	0.54 vol%	0.01 ppm
Acetylene	C ₂ H ₂	99.7 ppm	20.01 ppm
Ammonia	NH ₃	40.9 ppm	0.00 ppm
Arsine	AsH ₃	1.07 ppm	0.80 ppm
Bromomethane	CH ₃ Br	150 ppm	0.01 ppm
Carbon Dioxide	CO ₂	20.0 vol%	0.00 ppm
Carbon Monoxide	CO	100 ppm	0.03 ppm
Diborane	B ₂ H ₆	5.1 ppm	1.14 ppm
Disilane	Si ₂ H ₆	7.2 ppm	6.54 ppm
Ethanol	C ₂ H ₅ OH	8333 ppm	0.00 ppm
Ethyl Acetate	C ₄ H ₈ O ₂	0.53 vol%	0.01 ppm
Hydrogen	H ₂	500 ppm	0.05 ppm
Hydrogen Chloride	HCl	8.0 ppm	0.00 ppm
Hydrogen Cyanide	HCN	5.0 ppm	0.39 ppm
Hydrogen Selenide	H ₂ Se	10 ppm	4.45 ppm
Hydrogen Sulfide	H ₂ S	25.0 ppm	10.60 ppm
Isopropyl Alcohol	C ₃ H ₈ O	0.50 vol%	0.02 ppm
Methane	CH ₄	2.56 vol%	0.00 ppm
Methanol	CH ₃ OH	1.38 vol%	0.00 ppm
Nitrogen Dioxide	NO ₂	5.0 ppm	-1.28 ppm
Nitrogen Monoxide	NO	100 ppm	-0.44 ppm
Propylene	C ₃ H ₆	0.5 vol%	1.99 ppm
Silane	SiH ₄	7.2 ppm	4.08 ppm
Sulphur Dioxide	SO ₂	8.0 ppm	0.00 ppm
Toluene	C ₇ H ₈	1.0 vol%	-2.01 ppm
Xylene	C ₈ H ₁₀	1.0 vol%	-1.04 ppm

ESR-A13D-SO₂, SO₂ Detection

Table 24: Interference Chart for ESR-A13D-SO₂, SO₂ Detection

Gas	Chemical Formula	Concentration	Indication Value
Acetone	C ₃ H ₆ O	0.54 vol%	0.24 ppm
Acetylene	C ₂ H ₂	100 ppm	0.19 ppm
Ammonia	NH ₃	38.6 ppm	0.02 ppm
Benzene	C ₆ H ₆	0.30 vol%	0.73 ppm* ¹
Carbon Dioxide	CO ₂	20.0 vol%	0.02 ppm
Carbon Monoxide	CO	99.9ppm	0.54 ppm
Chlorine	Cl ₂	2.0 ppm	0.20 ppm
Cyclopentane	C ₅ H ₁₀	0.35 vol%	0.03 ppm
Ethane	C ₂ H ₆	0.75 vol%	0.02 ppm
Ethanol	C ₂ H ₅ OH	8333 ppm	0.22 ppm* ¹
Ethyl Acetate	C ₄ H ₈ O ₂	0.53 vol%	0.11 ppm
Fluorine	F ₂	1.6 ppm	0.04 ppm
Hydrogen	H ₂	500 ppm	0.80 ppm
Hydrogen Bromide	HBr	9.0 ppm	0.04 ppm
Hydrogen Chloride	HCl	3.2 ppm	0.06 ppm
Hydrogen Sulfide	H ₂ S	25.0 ppm	0.09 ppm
Isobutane	i-C ₄ H ₁₀	0.45 vol%	0.05 ppm
Isobuten	C ₄ H ₈	1000 ppm	27.19 ppm
Isopropyl Alcohol	C ₃ H ₈ O	0.50 vol%	0.63 ppm
Methane	CH ₄	1.26 vol%	0.09 ppm
Methanol	CH ₃ OH	1.38 vol%	2.32 ppm* ¹
Methyl Ethyl Ketone	C ₄ H ₈ O	0.45 vol%	1.09 ppm
Methyl Isobutyl Ketone	C ₆ H ₁₂ O	0.30 vol%	0.20 ppm
Methyl Methacrylate	C ₅ H ₈ O ₂	4250 ppm	0.13 ppm
n-Hexane	n-C ₆ H ₁₄	0.30 vol%	0.02 ppm
Nitrogen Dioxide	NO ₂	5.0 ppm	-5.01 ppm

Table 24: Interference Chart for ESR-A13D-SO₂, SO₂ Detection

Gas	Chemical Formula	Concentration	Indication Value
Nitrogen Monoxide	NO	99.2 ppm	3.13 ppm
Nonane	n-C ₉ H ₂₀	0.18 vol%	0.01 ppm
Ozone	O ₃	0.48 ppm	-0.30 ppm
Phosphine	PH ₃	2.51 ppm	0.02 ppm
Propane	C ₃ H ₈	0.49 vol%	0.01 ppm
Propylene	C ₃ H ₆	0.5 vol%	48.27 ppm
Tetrahydrofuran	C ₄ H ₈ O	0.50 vol%	0.90 ppm* ¹
Toluene	C ₇ H ₈	1.0 vol%	0.46 ppm* ¹
Xylene	C ₈ H ₁₀	1.0 vol%	0.12 ppm* ¹
* ¹ The indicated value may fluctuate when exposed to this gas.			

ESR-A13i-H2S, H₂S Detection

Table 25: Interference Chart for ESR-A13i-H2S, H₂S Detection

Gas	Chemical Formula	Concentration	Indication Value
Acetone	C ₃ H ₆ O	0.54 vol%	0.0 ppm
Acetylene	C ₂ H ₂	100 ppm	0.0 ppm
Ammonia	NH ₃	38.6 ppm	0.0 ppm
Benzene	C ₆ H ₆	0.30 vol%	0.0 ppm
Carbon Dioxide	CO ₂	20.0 vol%	0.0 ppm
Carbon Monoxide	CO	100.0 ppm	0.2 ppm
Chlorine	CL ₂	2.0 ppm	0.0 ppm
Cyclopentane	C ₅ H ₁₀	0.35 vol%	0.0 ppm
Ethane	C ₂ H ₆	0.75 vol%	0.0 ppm ^{*1}
Ethanol	C ₂ H ₅ OH	0.83 vol%	-0.5 ppm ^{*1}
Ethyl Acetate	C ₄ H ₈ O ₂	0.53 vol%	-0.1 ppm ^{*1}
Fluorine	F ₂	1.6 ppm	0.0 ppm
Hydrogen	H ₂	500 ppm	0.2 ppm
Hydrogen Bromide	HBr	9.0 ppm	0.0 ppm
Hydrogen Chloride	HCl	3.2 ppm	0.0 ppm
Isobutane	i-C ₄ H ₁₀	0.45 vol%	0.0 ppm
Isobuten	C ₄ H ₈	1000 ppm	0.1 ppm
Isopropyl Alcohol	C ₃ H ₈ O	2.0 vol%	-0.5 ppm
Methane	CH ₄	1.26 vol%	0.0 ppm
Methanol	CH ₃ OH	1.38 vol%	-0.6 ppm ^{*1}
Methyl Ethyl Ketone	C ₄ H ₈ O	0.45 vol%	0.0 ppm
Methyl Isobutyl Ketone	C ₆ H ₁₂ O	0.30 vol%	0.0 ppm
Methyl Methacrylate	C ₅ H ₈ O ₂	0.43 vol%	0.1 ppm ^{*1}
n-Hexane	n-C ₆ H ₁₄	0.30 vol%	0.0 ppm
Nitrogen Dioxide	NO ₂	5.0 ppm	-0.4 ppm
Nitrogen Monoxide	NO	99.2 ppm	2.6 ppm
Nonane	n-C ₉ H ₂₀	0.18 vol%	0.0 ppm

Table 25: Interference Chart for ESR-A13i-H2S, H₂S Detection

Gas	Chemical Formula	Concentration	Indication Value
Ozone	O ₃	0.48 ppm	0.0 ppm
Phosphine	PH ₃	2.51 ppm	1.0 ppm
Propane	C ₃ H ₈	0.49 vol%	0.0 ppm
Propylene	C ₃ H ₆	0.5 vol%	-0.2 ppm
Sulfur Dioxide	SO ₂	25.0 ppm	0.0 ppm
Tetrahydrofuran	C ₄ H ₈ O	0.50 vol%	-0.4 ppm
Toluene	C ₇ H ₈	1.0 vol%	0.0 ppm
Xylene	C ₈ H ₁₀	0.25 vol%	0.0 pm

*¹ The indicated value may fluctuate when exposed to this gas.

ESR-A13P-CO, CO Detection

Table 26: Interference Chart for ESR-A13P-CO, CO Detection

Gas	Chemical Formula	Concentration	Indication Value
Acetone	$(\text{CH}_3)_2\text{CO}$	5380 ppm	0 ppm
Acetylene	C_2H_2	99.6 ppm	50 ppm
Ammonia	NH_3	255 ppm	1 ppm
Arsine	AsH_3	1.1 ppm	4 ppm
Benzene	C_6H_6	0.3 vol%	-1 ppm
Carbon Dioxide	CO_2	100 vol%	8 ppm
Chlorine	Cl_2	0.8 ppm	0 ppm
Cyclopentane	C_5H_{10}	0.35 vol%	0 ppm
Diborane	B_2H_6	5.25 ppm	2 ppm
Ethane	C_2H_6	0.75 vol%	-1 ppm
Ethanol	$\text{CH}_3\text{CH}_2\text{OH}$	0.825 vol%	2 ppm* ¹
Ethyl Acetate	$\text{CH}_3\text{COOCH}_2\text{CH}_3$	0.525 vol%	-1 ppm
Fluorine	F_2	1.6 ppm	-1 ppm
Germane	GeH_4	10.2 ppm	3 ppm
Hydrogen	H_2	100 ppm	11 ppm
Hydrogen Chloride	HCl	11.7 ppm	-1 ppm
Hydrogen Cyanide	HCN	1.8 ppm	-1 ppm
Hydrogen Selenide	H_2Se	1 ppm	1 ppm
Hydrogen Sulfide	H_2S	30 ppm	0 ppm
Isobutane	C_4H_{10}	0.45 vol%	-1 ppm
Isobuten	$(\text{CH}_3)_2\text{C}=\text{CH}_2$	1000 ppm	2 ppm
Isopropyl Alcohol	$(\text{CH}_3)_2\text{CHOH}$	0.5 vol%	-1 ppm
Methane	CH_4	1.25 vol%	0 ppm
Methanol	CH_3OH	1000 ppm	3 ppm
Methyl Ethyl Ketone	$\text{C}_4\text{H}_8\text{O}$	0.45 vol%	-1 ppm
Methyl Isobutyl Ketone	$\text{C}_6\text{H}_{12}\text{O}$	3000 ppm	-1 ppm

Table 26: Interference Chart for ESR-A13P-CO, CO Detection

Gas	Chemical Formula	Concentration	Indication Value
Methyl Methacrylate	C ₅ H ₈ O ₂	0.425 vol%	0 ppm
n-Heptane	CH ₃ (CH ₂) ₅ CH ₃	0.275 vol%	-1 ppm
n-Hexane	CH ₃ (CH ₂) ₄ CH ₃	0.3 vol%	0 ppm
Nitrogen Dioxide	NO ₂	50.5 ppm	1 ppm
Nitrogen Monoxide	NO	99.2 ppm	53 ppm
Nonane	CH ₃ (CH ₂) ₇ CH ₃	0.175 vol%	0 ppm
Ozone	O ₃	1.8 ppm	0 ppm
Phosphine	PH ₃	2.5 ppm	3 ppm
Propane	C ₃ H ₈	0.5 vol%	0 ppm
Propylene	C ₃ H ₆	5000 ppm	16 ppm
Silane	SiH ₄	29.9 ppm	27 ppm
Sulfur Dioxide	SO ₂	30 ppm	0 ppm
Tetrahydrofuran	C ₄ H ₈ O	0.5 vol%	0 ppm
Toluene	C ₆ H ₅ CH ₃	3000 ppm	0 ppm
Xylene	C ₆ H ₄ (CH ₃) ₂	2500 ppm	0 ppm
*1 The indicated value may fluctuate when exposed to this gas.			

ESR-A1CP-COH, H₂-Compensated CO Detection

Table 27: Interference Chart for ESR-A1CP-COH, H₂-Compensated CO Detection

Gas	Chemical Formula	Concentration	Indication Value
Acetone	C ₃ H ₆ O	0.54 vol%	1 ppm
Acetylene	C ₂ H ₂	100 ppm	109 ppm
Ammonia	NH ₃	38.6 ppm	0 ppm
Benzene	C ₆ H ₆	0.30 vol%	0 ppm
Carbon Dioxide	CO ₂	20.0 vol%	0 ppm
Chlorine	Cl ₂	2.0 ppm	-1 ppm
Cyclopentane	C ₅ H ₁₀	0.35 vol%	1 ppm
Ethane	C ₂ H ₆	0.75 vol%	0 ppm
Ethanol	C ₂ H ₅ OH	0.83 vol%	4 ppm* ¹
Ethyl Acetate	C ₄ H ₈ O ₂	0.53 vol%	1 ppm
Fluorine	F ₂	1.6 ppm	-1 ppm
Hydrogen	H ₂	500 ppm	7 ppm
Hydrogen Bromide	HBr	9.0 ppm	0 ppm
Hydrogen Chloride	HCl	15.8 ppm	0 ppm
Hydrogen Sulfide	H ₂ S	24.2 ppm	0 ppm
Isobutane	i-C ₄ H ₁₀	0.45 vol%	0 ppm
Isobuten	C ₄ H ₈ O	1000 ppm	3 ppm
Isopropyl Alcohol	C ₃ H ₈ O	0.50 vol%	0 ppm
Nitrogen Monoxide	NO	99.2 ppm	53 ppm
Nitrogen Dioxide	NO ₂	50.5 ppm	0 ppm
Methane	CH ₄	1.26 vol%	1 ppm
Methanol	CH ₃ OH	1.38 vol%	131 ppm* ¹
Methyl Ethyl Ketone	C ₄ H ₈ O	0.45 vol%	0 ppm
Methyl Isobutyl Ketone	C ₆ H ₁₂ O	0.30 vol%	0 ppm
Methyl Methacrylate	C ₅ H ₈ O ₂	0.43 vol%	1 ppm
n-Hexane	n-C ₆ H ₁₄	0.30 vol%	1 ppm

Table 27: Interference Chart for ESR-A1CP-COH, H₂-Compensated CO Detection

Gas	Chemical Formula	Concentration	Indication Value
Nonane	n-C ₉ H ₂₀	0.18 vol%	0 ppm
Ozone	O ₃	0.48 ppm	0 ppm
Phosphine	PH ₃	2.51 ppm	3 ppm
Propane	C ₃ H ₈	0.49 vol%	0 ppm
Propylene	C ₃ H ₆	0.50 vol%	78 ppm* ¹
Sulfur Dioxide	SO ₂	25.0 ppm	1 ppm
Tetrahydrofuran	C ₄ H ₈ O	0.50 vol%	1 ppm
Toluene	C ₇ H ₈	0.30 vol%	1 ppm
Xylene	C ₈ H ₁₀	0.25 vol%	0 ppm
* ¹ The indicated value may fluctuate when exposed to this gas.			

ESR-A1DP-COHS, CO Detection

Table 28: Interference Chart for ESR-A1DP-COHS, CO Detection

Gas	Chemical Formula	Concentration	Indication Value
Acetone	$(\text{CH}_3)_2\text{CO}$	0.538 vol%	-1 ppm
Acetylene	C_2H_2	99.6 ppm	84 ppm
Ammonia	NH_3	255 ppm	2 ppm
Arsine	AsH_3	1.1 ppm	4 ppm
Benzene	C_6H_6	0.3 vol%	-1 ppm
Carbon Dioxide	CO_2	100 vol%	8 ppm
Chlorine	Cl_2	0.8 ppm	-1 ppm
Cyclopentane	C_5H_{10}	0.35 vol%	0 ppm
Diborane	B_2H_6	5.25 ppm	2 ppm
Ethane	C_2H_6	0.75 vol%	0 ppm
Ethanol	$\text{CH}_3\text{CH}_2\text{OH}$	0.825 vol%	25 ppm ^{*1}
Ethyl Acetate	$\text{CH}_3\text{COOCH}_2\text{CH}_3$	0.525 vol%	9 ppm ^{*1}
Fluorine	F_2	1.6 ppm	0 ppm
Germane	GeH_4	10.2 ppm	7 ppm
Hydrogen	H_2	100 ppm	17 ppm
Hydrogen Chloride	HCl	11.7 ppm	-1 ppm
Hydrogen Cyanide	HCN	1.8 ppm	-1 ppm
Hydrogen Selenide	H_2Se	1 ppm	2 ppm
Hydrogen Sulfide	H_2S	30 ppm	2 ppm
Isobutane	C_4H_{10}	0.45 vol%	0 ppm
Isobuten	$(\text{CH}_3)_2\text{C}=\text{CH}_2$	1000 ppm	9 ppm
Isopropyl Alcohol	$(\text{CH}_3)_2\text{CHOH}$	0.5 vol%	15 ppm ^{*1}
Methane	CH_4	1.25 vol%	-1 ppm
Methanol	CH_3OH	1000 ppm	10 ppm ^{*1}
Methyl Ethyl Ketone	$\text{C}_4\text{H}_8\text{O}$	0.45 vol%	-1 ppm
Methyl Isobutyl Ketone	$\text{C}_6\text{H}_{12}\text{O}$	0.3 vol%	0 ppm
Methyl Methacrylate	$\text{C}_5\text{H}_8\text{O}_2$	0.425 vol%	2 ppm

Table 28: Interference Chart for ESR-A1DP-COHS, CO Detection

Gas	Chemical Formula	Concentration	Indication Value
n-Heptane	CH ₃ (CH ₂) ₅ CH ₃	0.275 vol%	-1 ppm
n-Hexane	CH ₃ (CH ₂) ₄ CH ₃	0.3 vol%	0 ppm
Nitrogen Dioxide	NO ₂	50.5 ppm	1 ppm
Nitrogen Monoxide	NO	99.2 ppm	38 ppm
Nonane	CH ₃ (CH ₂) ₇ CH ₃	0.175 vol%	0 ppm
Ozone	O ₃	1.8 ppm	0 ppm
Phosphine	PH ₃	2.5 ppm	3 ppm
Propane	C ₃ H ₈	0.5 vol%	0 ppm
Propylene	C ₃ H ₆	0.5 vol%	42 ppm ^{*1}
Silane	SiH ₄	29.9 ppm	46 ppm
Sulfur Dioxide	SO ₂	30 ppm	3 ppm
Tetrahydrofuran	C ₄ H ₈ O	0.5 vol%	21 ppm
Toluene	C ₆ H ₅ CH ₃	0.3 vol%	0 ppm
Xylene	C ₆ H ₄ (CH ₃) ₂	0.25 vol%	0 ppm
* ¹ The indicated value may fluctuate when exposed to this gas.			

ESR-A1DP-COHS, H₂S Detection

Table 29: Interference Chart for ESR-A1DP-COHS, H₂S Detection

Gas	Chemical Formula	Concentration	Indication Value
Acetone	CH ₃ COCH ₃	0.538 vol%	-0.1 ppm
Acetylene	C ₂ H ₂	99.6 ppm	-0.1 ppm
Ammonia	NH ₃	250 ppm	-0.1 ppm
Arsine	AsH ₃	1.1 ppm	0.5 ppm
Benzene	C ₆ H ₆	0.3 vol%	-0.1 ppm
Carbon Dioxide	CO ₂	100 vol%	-0.1 ppm
Carbon Monoxide	CO	1000 ppm	2.6 ppm
Chlorine	Cl ₂	0.8 ppm	-0.1 ppm
Cyclopentane	C ₅ H ₁₀	0.35 vol%	-0.1 ppm
Diborane	B ₂ H ₆	5.25 ppm	0.2 ppm
Ethane	C ₂ H ₆	0.75 vol%	0.0 ppm
Ethanol	CH ₃ CH ₂ OH	0.825 vol%	0.5 ppm
Ethyl Acetate	CH ₃ COOH ₂ CH ₃	0.525 vol%	-0.1 ppm
Fluorine	F ₂	1.6 ppm	-0.1 ppm
Germane	GeH ₄	10.2 ppm	0.3 ppm
Hydrogen	H ₂	2000 ppm	1.3 ppm
Hydrogen Chloride	HCl	11.7 ppm	-0.2 ppm
Hydrogen Cyanide	HCN	1.8 ppm	0.0 ppm
Hydrogen Selenide	H ₂ Se	1 ppm	0.3 ppm
Isobutane	C ₄ H ₁₀	0.45 vol%	-0.1 ppm
Isobuten	CH ₂ CH(CH ₃) ₂	1000 ppm	0.1 ppm
Isopropyl Alcohol	CH ₃ C(OH)CH ₃	0.5 vol%	0.0 ppm
Methane	CH ₄	1.25 vol%	-0.1 ppm
Methanol	CH ₃ OH	1.375 vol%	0.5 ppm
Methyl Ethyl Ketone	C ₄ H ₈ O	0.45 vol%	0.3 ppm
Methyl Isobutyl Ketone	C ₆ H ₁₂ O	0.3 vol%	-0.1 ppm

Table 29: Interference Chart for ESR-A1DP-COHS, H₂S Detection

Gas	Chemical Formula	Concentration	Indication Value
Methyl Methacrylate	C ₅ H ₈ O ₂	0.425 vol%	-0.1 ppm
n-Heptane	CH ₃ (CH ₂) ₅ CH ₃	0.275 vol%	-0.1 ppm
n-Hexane	CH ₃ (CH ₂) ₄ CH ₃	0.3 vol%	-0.1 ppm
Nitrogen Dioxide	NO ₂	50.5 ppm	-4.6 ppm
Nitrogen Monoxide	NO	99.2 ppm	6.0 ppm
Nonane	CH ₃ (CH ₂) ₇ CH ₃	0.175 vol%	0.2 ppm
Ozone	O ₃	1.8 ppm	-0.1 ppm
Phosphine	PH ₃	2.5 ppm	1.5 ppm
Propane	C ₃ H ₈	0.5 vol%	-0.1 ppm
Propylene	C ₃ H ₆	0.5 vol%	-0.1 ppm
Silane	SiH ₄	29.9 ppm	0.6 ppm
Sulfur Dioxide	SO ₂	30 ppm	-0.1 ppm
Tetrahydrofuran	C ₄ H ₈ O	0.5 vol%	0.1 ppm
Toluene	C ₆ H ₅ CH ₃	0.3 vol%	-0.1 ppm
Xylene	C ₆ H ₅ (CH ₃) ₂	0.25 vol%	-0.1 ppm

ESR-B134-NH3, NH₃ Detection

Table 30: Interference Chart for ESR-B134-NH3, NH₃ Detection

Gas	Chemical Formula	Concentration	Indication Value
Carbon Dioxide	CO ₂	1 vol%	0.3 ppm
Carbon Monoxide	CO	50 ppm	0.7 ppm
Chlorine	Cl ₂	0.8 ppm	1.1 ppm
Ethanol	C ₂ H ₅ OH	0.83 vol%	5.4 ppm
Hydrogen	H ₂	500 ppm	0.7 ppm
Hydrogen Chloride	HCl	8 ppm	0.5 ppm
Hydrogen Cyanide	HCN	8.0 ppm	2.5 ppm
Hydrogen Sulfide	H ₂ S	30 ppm	0.6 ppm
Isobutane	C ₄ H ₁₀	0.89 vol%	0.9 ppm
Methane	CH ₄	2.21 vol%	1.0 ppm
Nitric Oxide	NO	101 ppm	0.8 ppm
Nitrogen Dioxide	NO ₂	99 ppm	-23.9 ppm
Oxygen	O ₂	100 vol%	0.4 ppm
Ozone	O ₃	0.3 ppm	8.5 ppm
Phosphine	PH ₃	0.5 ppm	1.0 ppm
Sulfur Dioxide	SO ₂	30 ppm	1.0 ppm

Warranty

RKI Instruments, Inc. warrants the GX-3R Pro sold by us to be free from defects in materials, workmanship, and performance for a period of three years from the date of shipment from RKI Instruments, Inc. This includes the instrument and the original sensors. Replacement parts are warranted for 1 year from the date of their shipment from RKI Instruments, Inc. except for replacement sensors which are warranted for 3 years. Any parts found defective within their warranty period will be repaired or replaced, at our option, free of charge. This warranty does not apply to those items which by their nature are subject to deterioration or consumption in normal service, and which must be cleaned, repaired, or replaced on a routine basis. Examples of such items are:

Absorbent cartridges

Filter elements, disks, or sheets

Pump diaphragms and valves

Warranty is voided by abuse including mechanical damage, alteration, rough handling, or repair procedures not in accordance with the instruction manual. This warranty indicates the full extent of our liability, and we are not responsible for removal or replacement costs, local repair costs, transportation costs, or contingent expenses incurred without our prior approval.

THIS WARRANTY IS EXPRESSLY IN LIEU OF ANY AND ALL OTHER WARRANTIES AND REPRESENTATIONS, EXPRESSED OR IMPLIED, AND ALL OTHER OBLIGATIONS OR LIABILITIES ON THE PART OF RKI INSTRUMENTS, INC. INCLUDING BUT NOT LIMITED TO THE WARRANTY OF MERCHANTABILITY OR FITNESS FOR A PARTICULAR PURPOSE. IN NO EVENT SHALL RKI INSTRUMENTS, INC. BE LIABLE FOR INDIRECT, INCIDENTAL, OR CONSEQUENTIAL LOSS OR DAMAGE OF ANY KIND CONNECTED WITH THE USE OF ITS PRODUCTS OR FAILURE OF ITS PRODUCTS TO FUNCTION OR OPERATE PROPERLY.

This warranty covers instruments and parts sold to users only by authorized distributors, dealers, and representatives as appointed by RKI Instruments, Inc.

We do not assume indemnification for any accident or damage caused by the operation of this gas monitor and our warranty is limited to replacement of parts or our complete goods.