

**FLUKE®**

**725**

Multifunction Process Calibrator

Users Manual

October, 1998 Rev.3, 5/04

© 1998-2004 Fluke Corporation, All rights reserved.

All product names are trademarks of their respective companies.

### **LIMITED WARRANTY AND LIMITATION OF LIABILITY**

Each Fluke product is warranted to be free from defects in material and workmanship under normal use and service. The warranty period is three years and begins on the date of shipment. Parts, product repairs, and services are warranted for 90 days. This warranty extends only to the original buyer or end-user customer of a Fluke authorized reseller, and does not apply to fuses, disposable batteries, or to any product which, in Fluke's opinion, has been misused, altered, neglected, contaminated, or damaged by accident or abnormal conditions of operation or handling. Fluke warrants that software will operate substantially in accordance with its functional specifications for 90 days and that it has been properly recorded on non-defective media. Fluke does not warrant that software will be error free or operate without interruption.

Fluke authorized resellers shall extend this warranty on new and unused products to end-user customers only but have no authority to extend a greater or different warranty on behalf of Fluke. Warranty support is available only if product is purchased through a Fluke authorized sales outlet or Buyer has paid the applicable international price. Fluke reserves the right to invoice Buyer for importation costs of repair/replacement parts when product purchased in one country is submitted for repair in another country.

Fluke's warranty obligation is limited, at Fluke's option, to refund of the purchase price, free of charge repair, or replacement of a defective product which is returned to a Fluke authorized service center within the warranty period.

To obtain warranty service, contact your nearest Fluke authorized service center to obtain return authorization information, then send the product to that service center, with a description of the difficulty, postage and insurance prepaid (FOB Destination). Fluke assumes no risk for damage in transit. Following warranty repair, the product will be returned to Buyer, transportation prepaid (FOB Destination). If Fluke determines that failure was caused by neglect, misuse, contamination, alteration, accident, or abnormal condition of operation or handling, including overvoltage failures caused by use outside the product's specified rating, or normal wear and tear of mechanical components, Fluke will provide an estimate of repair costs and obtain authorization before commencing the work. Following repair, the product will be returned to the Buyer transportation prepaid and the Buyer will be billed for the repair and return transportation charges (FOB Shipping Point).

**THIS WARRANTY IS BUYER'S SOLE AND EXCLUSIVE REMEDY AND IS IN LIEU OF ALL OTHER WARRANTIES, EXPRESS OR IMPLIED, INCLUDING BUT NOT LIMITED TO ANY IMPLIED WARRANTY OF MERCHANTABILITY OR FITNESS FOR A PARTICULAR PURPOSE. FLUKE SHALL NOT BE LIABLE FOR ANY SPECIAL, INDIRECT, INCIDENTAL OR CONSEQUENTIAL DAMAGES OR LOSSES, INCLUDING LOSS OF DATA, ARISING FROM ANY CAUSE OR THEORY.**

Since some countries or states do not allow limitation of the term of an implied warranty, or exclusion or limitation of incidental or consequential damages, the limitations and exclusions of this warranty may not apply to every buyer. If any provision of this Warranty is held invalid or unenforceable by a court or other decision-maker of competent jurisdiction, such holding will not affect the validity or enforceability of any other provision.

# Table of Contents

| Title   | Page |
|---|------|
| Introduction.....                                     | 1    |
| Standard Equipment.....                               | 3    |
| Safety Information.....                               | 3    |
| Getting Acquainted with the Calibrator .....          | 8    |
| Input and Output Terminals .....                      | 8    |
| Keys.....   | 10   |
| Display .....   | 13   |
| Getting Started .....                                 | 14   |
| Shut Down Mode .....                                  | 14   |
| Contrast Adjustment .....                             | 16   |
| Using Measure Mode.....                               | 17   |
| Measuring Electrical Parameters (Upper Display) ..... | 17   |
| Current Measurement with Loop Power.....              | 17   |
| Measuring Electrical Parameters (Lower Display) ..... | 19   |
| Measuring Temperature.....                            | 20   |

---

|   |    |
|---|----|
| Using Thermocouples .....                           | 20 |
| Using Resistance-Temperature Detectors (RTDs) ..... | 23 |
| Measuring Pressure .....                            | 26 |
| Zeroing with Absolute Pressure Modules .....        | 27 |
| Using Source Mode .....                             | 29 |
| Sourcing 4 to 20 mA .....                           | 29 |
| Simulating a 4- to 20-mA Transmitter .....          | 29 |
| Sourcing Other Electrical Parameters .....          | 29 |
| Simulating Thermocouples .....                      | 32 |
| Simulating RTDs.....                                | 32 |
| Sourcing Pressure .....                             | 35 |
| Setting 0 % and 100 % Output Parameters .....       | 37 |
| Stepping and Ramping the Output .....               | 37 |
| Manually Stepping the mA Output.....                | 37 |
| Auto Ramping the Output.....                        | 38 |
| Storing and Recalling Setups.....                   | 38 |
| Calibrating a Transmitter .....                     | 39 |
| Calibrating a Pressure Transmitter.....             | 41 |
| Calibrating an I/P Device.....                      | 43 |
| Testing an Output Device.....                       | 45 |
| Remote Control Commands.....                        | 46 |
| Replacing the Batteries .....                       | 49 |
| Replacing the Fuses .....                           | 49 |
| Maintenance.....                                    | 50 |
| Cleaning the Calibrator.....                        | 50 |
| Service Center Calibration or Repair.....           | 50 |
| Replacement Parts .....                             | 51 |
| Accessories.....                                    | 53 |

**Contents** (continued)

---

|  |    |
|--|----|
| External Fluke Pressure Module Compatibility .....     | 53 |
| Specifications.....                                    | 56 |
| DC Voltage Measurement.....                            | 56 |
| DC Voltage Source .....                                | 56 |
| Millivolt Measurement and Source*.....                 | 56 |
| DC mA Measurement and Source .....                     | 57 |
| Ohms Measurement.....                                  | 57 |
| Ohms Source .....                                      | 57 |
| Frequency Measurement .....                            | 57 |
| Frequency Source.....                                  | 58 |
| Temperature, Thermocouples.....                        | 58 |
| Loop Power Supply.....                                 | 59 |
| RTD Excitation (simulation) .....                      | 59 |
| Temperature, RTD Ranges, and Accuracies (ITS-90) ..... | 59 |
| Pressure Measurement.....                              | 60 |
| General Specifications.....                            | 60 |

# List of Tables

| Table | Title  | Page |
|-------|--|------|
| 1.    | Summary of Source and Measure Functions..... | 2    |
| 2.    | International Symbols .....                  | 7    |
| 3.    | Input/Output Terminals and Connectors.....   | 9    |
| 4.    | Key Functions .....                          | 11   |
| 5.    | Thermocouple Types Accepted .....            | 21   |
| 6.    | RTD Types Accepted.....                      | 24   |
| 7.    | mA Step Values .....                         | 38   |
| 8A.   | Remote Control Upper Display .....           | 46   |
| 8B.   | Remote Control Lower Display .....           | 46   |
| 8C.   | "S" Commands Select Sensor Type .....        | 48   |
| 9.    | Replacement Parts .....                      | 51   |
| 10.   | Fluke Pressure Module Compatibility .....    | 53   |
| 11.   | Pressure Modules.....                        | 54   |

## List of Figures

| Figure | Title  | Page |
|--------|--|------|
| 1.     | Standard Equipment .....   | 6    |
| 2.     | Input/Output Terminals and Connectors .....                                      | 8    |
| 3.     | Keys .....   | 10   |
| 4.     | Elements of a Typical Display .....  | 13   |
| 5.     | Voltage-to-Voltage Test .....  | 15   |
| 6.     | Adjusting the Contrast .....   | 16   |
| 7.     | Measuring Voltage and Current Output .....                                       | 17   |
| 8.     | Connections for Supplying Loop Power .....                                       | 18   |
| 9.     | Measuring Electrical Parameters .....  | 19   |
| 10.    | Measuring Temperature with a Thermocouple .....                                  | 22   |
| 11.    | Measuring Temperature with an RTD, Measuring 2-, 3-, and 4-Wire Resistance ..... | 25   |
| 12.    | Gage and Differential Pressure Modules .....                                     | 26   |
| 13.    | Connections for Measuring Pressure .....   | 28   |
| 14.    | Connections for Simulating a 4- to 20-mA Transmitter .....                       | 30   |
| 15.    | Electrical Sourcing Connections .....  | 31   |
| 16.    | Connections for Simulating a Thermocouple .....                                  | 33   |
| 17.    | Connection for Simulating a 3-Wire RTD .....                                     | 34   |

**725**

*Users Manual*

---

|  |    |
|--|----|
| 18. Connections for Sourcing Pressure .....                  | 36 |
| 19. Calibrating a Thermocouple Transmitter .....             | 40 |
| 20. Calibrating a Pressure-to-Current (P/I) Transmitter..... | 42 |
| 21. Calibrating a Current-to-Pressure (I/P) Transmitter..... | 44 |
| 22. Calibrating a Chart Recorder.....                        | 45 |
| 23. Replacing the Batteries .....                            | 50 |
| 24. Replacement Parts .....                                  | 52 |



# ***Multifunction Process Calibrator***

## ***Introduction***

Your Fluke 725 Multifunction Process Calibrator (referred to as “the calibrator”) is a handheld, battery-operated instrument that measures and sources electrical and physical parameters. See Table 1.

In addition to the functions in Table 1, the calibrator has the following features and functions:

- A split-screen display. The upper display allows you to measure volts, current, and pressure only. The lower display allows you to measure and source volts, current, pressure, resistance temperature detectors, thermocouples, frequency, and ohms.
  - Calibrates a transmitter using the split-screen.
  - A thermocouple (TC) input/output terminal and internal isothermal block with automatic reference-junction temperature compensation.
  - Stores and recalls setups.
- Manual stepping and automatic stepping and ramping.
  - Controls the calibrator remotely from a PC running a terminal emulator program.

Table 1. Summary of Source and Measure Functions

| Function  | Measure  | Source  |
|---|--|---|
| dc V  | 0 V to 30 V  | 0 V to 10 V   |
| dc mA   | 0 to 24 mA   | 0 to 24 mA  |
| Frequency                                       | 1 CPM to 10 kHz  | 1 CPM to 10 kHz   |
| Resistance                                      | 0 $\Omega$ to 3200 $\Omega$  | 15 $\Omega$ to 3200 $\Omega$  |
| Thermocouple                                    | Types E, J, K, T, B, R, S, L, U, N, mV   |   |
| RTD<br>(Resistance-<br>Temperature<br>Detector) | Pt100 $\Omega$ (385)<br>Pt100 $\Omega$ (3926)<br>Pt100 $\Omega$ (3916)<br>Pt200 $\Omega$ (385)<br>Pt500 $\Omega$ (385)<br>Pt1000 $\Omega$ (385)<br>Ni120 |   |
| Pressure  | 27 modules ranging from 10 in. H <sub>2</sub> O to 10,000 psi  | 27 modules ranging from 10 in. H <sub>2</sub> O to 10,000 psi using an external pressure source (hand pump) |
| Other functions                                 | Loop supply, Step, Ramp, Memory, Dual display  |   |

### **Standard Equipment**

The items listed below and shown in Figure 1 are included with your calibrator. If the calibrator is damaged or something is missing, contact the place of purchase immediately. To order replacement parts or spares, see the user-replaceable parts list in Table 9.

- TL75 test leads (one set)
- AC70A alligator clips (one set)
- Stackable alligator clip test leads (one set)
- *725 Product Overview Manual*
- *725 CD-ROM* (contains Users Manual)
- Spare fuse

### **Safety Information**

The calibrator is designed in accordance with IEC1010-1, ANSI/ISA S82.01-1994 and CAN/CSA C22.2 No. 1010.1-92. Use the calibrator only as specified in this manual, otherwise the protection provided by the calibrator may be impaired.

A **Warning** identifies conditions and actions that pose hazard(s) to the user; a **Caution** identifies conditions and actions that may damage the calibrator or the equipment under test.

International symbols used on the calibrator and in this manual are explained in Table 2.

**⚠ Warning**

To avoid possible electric shock or personal injury:

- Do not apply more than the rated voltage, as marked on the calibrator, between the terminals, or between any terminal and earth ground (30 V 24 mA max all terminals).
- Before each use, verify the calibrator's operation by measuring a known voltage.
- Follow all equipment safety procedures.
- Never touch the probe to a voltage source when the test leads are plugged into the current terminals.
- Do not use the calibrator if it is damaged. Before you use the calibrator, inspect the case. Look for cracks or missing plastic. Pay particular attention to the insulation surrounding the connectors.
- Select the proper function and range for your measurement.
- Make sure the battery door is closed and latched before you operate the calibrator.
- Remove test leads from the calibrator before you open the battery door.
- Inspect the test leads for damaged insulation or exposed metal. Check test leads continuity. Replace damaged test leads before you use the calibrator.
- When using the probes, keep your fingers away from the probe contacts. Keep your fingers behind the finger guards on the probes.
- Connect the common test lead before you connect the live test lead. When you disconnect test leads, disconnect the live test lead first.
- Do not use the calibrator if it operates abnormally. Protection may be impaired. When in doubt, have the calibrator serviced.
- Do not operate the calibrator around explosive gas, vapor, or dust.

**⚠ Warning**

- When using a pressure module, make sure the process pressure line is shut off and depressurized before you connect it or disconnect it from the pressure module.
- Use only 4 AA batteries, properly installed in the calibrator case, to power the calibrator.
- Disconnect test leads before changing to another measure or source function.
- When servicing the calibrator, use only specified replacement parts.
- To avoid false readings, which could lead to possible electric shock or personal injury, replace the battery as soon as the battery indicator (⊕) appears.

**Caution**

To avoid possible damage to calibrator or to equipment under test:

- Disconnect the power and discharge all high-voltage capacitors before testing resistance or continuity.
- Use the proper jacks, function, and range for your measurement or sourcing application.

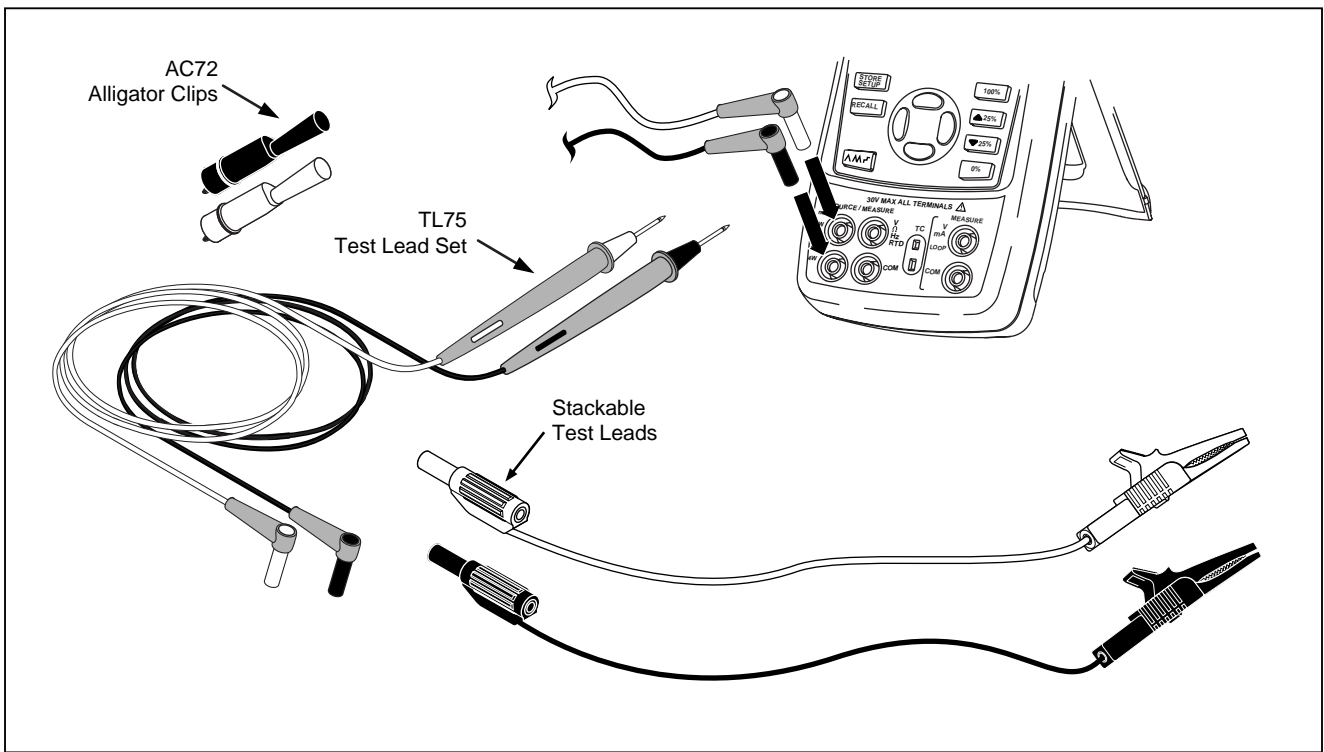











Figure 1. Standard Equipment

sh01f.eps

**Table 2. International Symbols**

|  |   |  |   |
|--|---|--|---|
|   | AC - Alternating current                              |   | Double insulated  |
|   | DC - Direct current                                   |   | Battery   |
|   | Earth ground  |   | Refer to the manual for information about this feature. |
|   | Pressure  |   | ON/OFF  |
|  | Conforms to Canadian Standards Association directives |  | Conforms to European Union directives                   |

## Getting Acquainted with the Calibrator

### Input and Output Terminals

Figure 2 shows the calibrator input and output terminals. Table 3 explains their use.

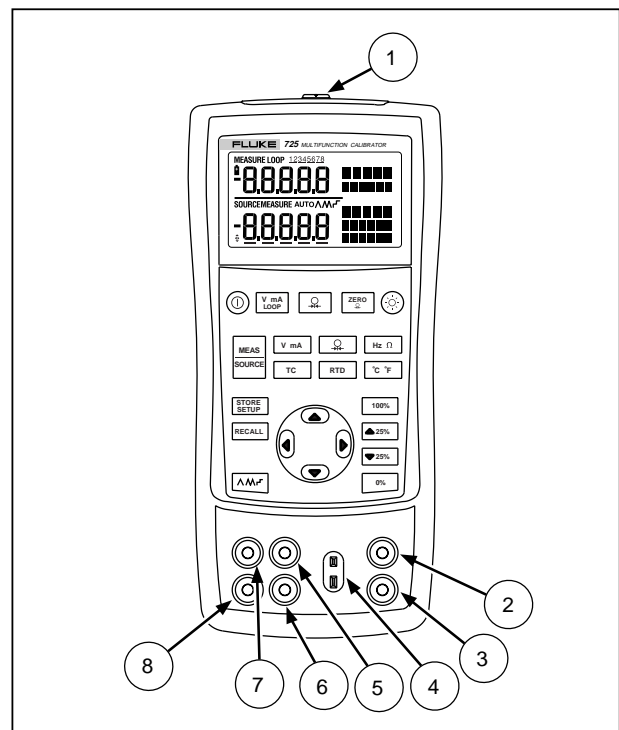

sh05f.eps

Figure 2. Input/Output Terminals and Connectors



**Table 3. Input/Output Terminals and Connectors**

| No   | Name   | Description  |
|------|--|--|
| ①    | Pressure module connector                      | Connects the calibrator to a pressure module or the calibrator to a PC for a remote control connection.  |
| ②, ③ | MEASURE V, mA terminals                        | Input terminals for measuring voltage, current, and supplying loop power.  |
| ④    | TC input/output                                | Terminal for measuring or simulating thermocouples. This terminal accepts a miniature polarized thermocouple plug with flat, in-line blades spaced 7.9 mm (0.312 in) center to center. |
| ⑤, ⑥ | SOURCE/ MEASURE V, RTD, Hz, $\Omega$ terminals | Terminals for sourcing or measuring voltage, resistance, frequency, and RTDs.  |
| ⑦, ⑧ | SOURCE/ MEASURE mA terminals, 3W, 4W           | Terminals for sourcing and measuring current, and performing 3W and 4W RTD measurements.   |

**Keys**

Figure 3 shows the calibrator keys and Table 4 explains their use.

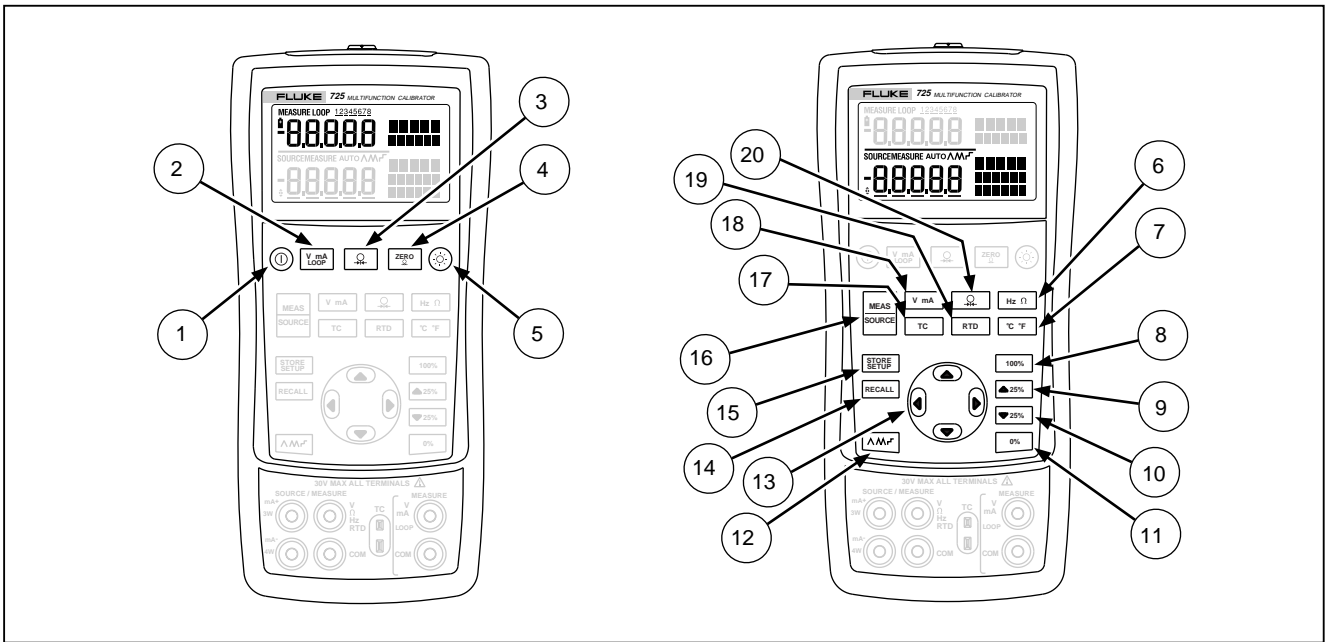

Figure 3. Keys

sh41f.eps

Table 4. Key Functions























| No | Name  | Description   |
|----|---|---|
| ①  |    | Turns the power on or off.  |
| ②  |    | Selects voltage, mA or Loop Power measurement function in the upper display.  |
| ③  |    | Selects the pressure measurement function in the upper display. Repeated pushes cycle through the different pressure units.   |
| ④  |    | Zeros the pressure module reading. This applies to both upper and lower displays.   |
| ⑤  |  | Turns backlight on or off. Turns Contrast Adjust mode on when powering up.  |
| ⑥  |  | Toggles frequency and ohms measurement and sourcing functions.  |
| ⑦  |  | Toggles between Centigrade or Fahrenheit when in TC or RTD functions.   |
| ⑧  |  | Recalls from memory a source value corresponding to 100 % of span and sets it as the source value. Press and hold to store the source value as the 100 % value.   |
| ⑨  |  | Increments output by 25 % of span.  |
| ⑩  |  | Decrements output by 25 % of span.  |
| ⑪  |  | Recalls from memory a source value corresponding to 0 % of span and sets it as the source value. Press and hold to store the source value as the 0 % value.<br>Identifies Firmware version. Press and hold  when powering up. |

Table 4. Key Functions (cont.)

| No   | Name  | Description  |
|------|---|--|
| 12   |    | Cycles through :<br>$\wedge$ Slow repeating 0 % - 100 % - 0 % ramp<br>$\lambda$ Fast repeating 0 % - 100 % - 0 % ramp<br>$\square$ Repeating 0 % - 100 % - 0 % ramp in 25 % steps  |
| 1 13 |    | Disables Shut Down Mode  |
| 1 13 |    | Enables Shut Down Mode   |
| 13   |   | Increases or decreases the source level.<br>Cycles through the 2-, 3-, and 4-wire selections.<br>Moves through the memory locations of calibrator setups.<br>In Contrast Adjustment mode; up-darkens contrast, down-lightens contrast. |
| 14   |  | Retrieves a previous calibrator setup from a memory location.  |
| 15   |  | Saves the calibrator setup. Saves Contrast Adjust setup.   |
| 16   |  | Cycles the calibrator through MEASURE and SOURCE modes in the lower display.   |
| 17   |  | Selects TC (thermocouple) measurement and sourcing function in the lower display. Repeated pushes cycle through the thermocouple types.  |
| 18   |  | Toggles between voltage, mA sourcing, or mA simulate functions in the lower display.   |
| 19   |  | Selects RTD (resistance temperature detector) measurement and sourcing function in lower display. Repeated pushes cycle through the RTD types.   |
| 20   |  | Selects the pressure measurement and sourcing function. Repeated pushes cycle through the different pressure units.  |

**Display**

Figure 4 shows the elements of a typical display.

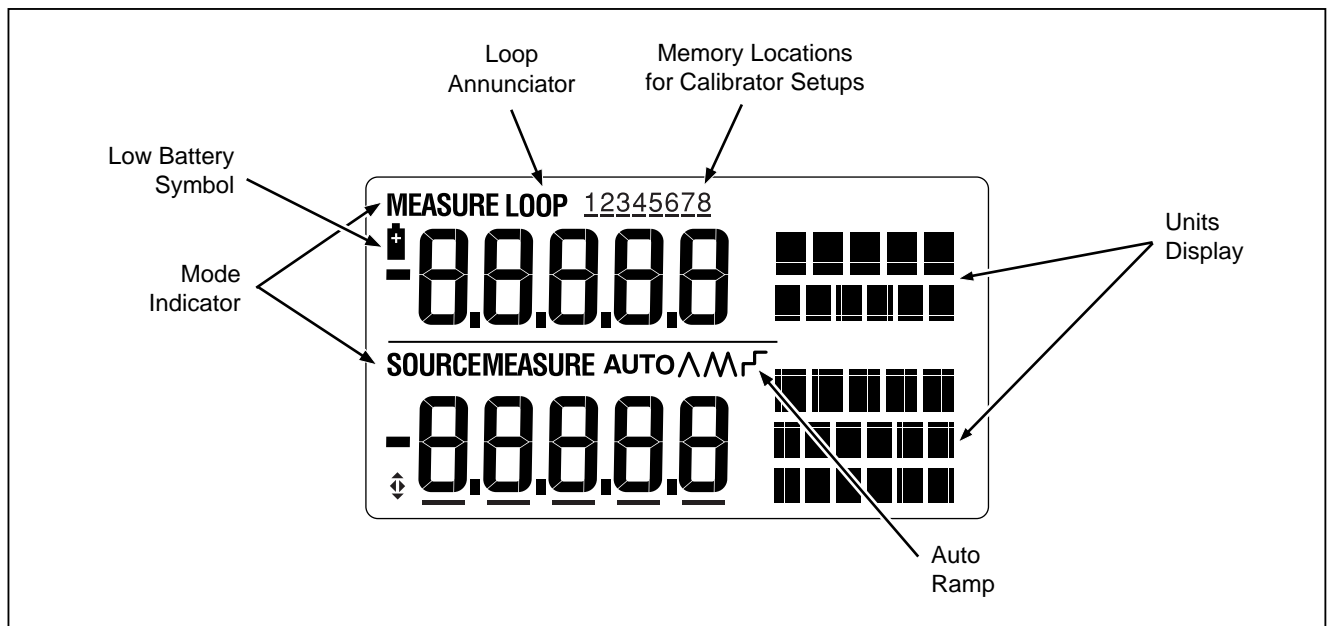









Figure 4. Elements of a Typical Display





sh07f.eps

## Getting Started









This section acquaints you with some basic operations of the calibrator.

Proceed as follows to perform a voltage-to-voltage test:

1. Connect the calibrator's voltage output to its voltage input as shown in Figure 5.
2. Press  to turn on the calibrator. Press  to select dc voltage (upper display).
3. If necessary, press  for SOURCE mode (lower display). The calibrator is still measuring dc voltage, and you can see the active measurements in the upper display.
4. Press  to select dc voltage sourcing.
5. Press  and  to select a digit to change. Press  to select 1 V for the output value. Press and hold  to enter 1 V as the 0 % value.

6. Press  to increase the output to 5 V. Press and hold  to enter 5 V as the 100 % value.
7. Press  and  to step between 0 and 100 % in 25 % step increments.

## Shut Down Mode

The calibrator comes with the Shut Down mode enabled for a time duration set to 30 minutes (displayed for about 1 second when the calibrator is initially turned on). When the Shut Down mode is enabled, the calibrator will automatically shut down after the time duration has elapsed from the time the last key was pressed. To disable the Shut Down mode, press  and  simultaneously. To enable the mode, press  and  simultaneously. To adjust the time duration, press  and  simultaneously, then press  and/or  to adjust the time between 1 and 30 minutes.

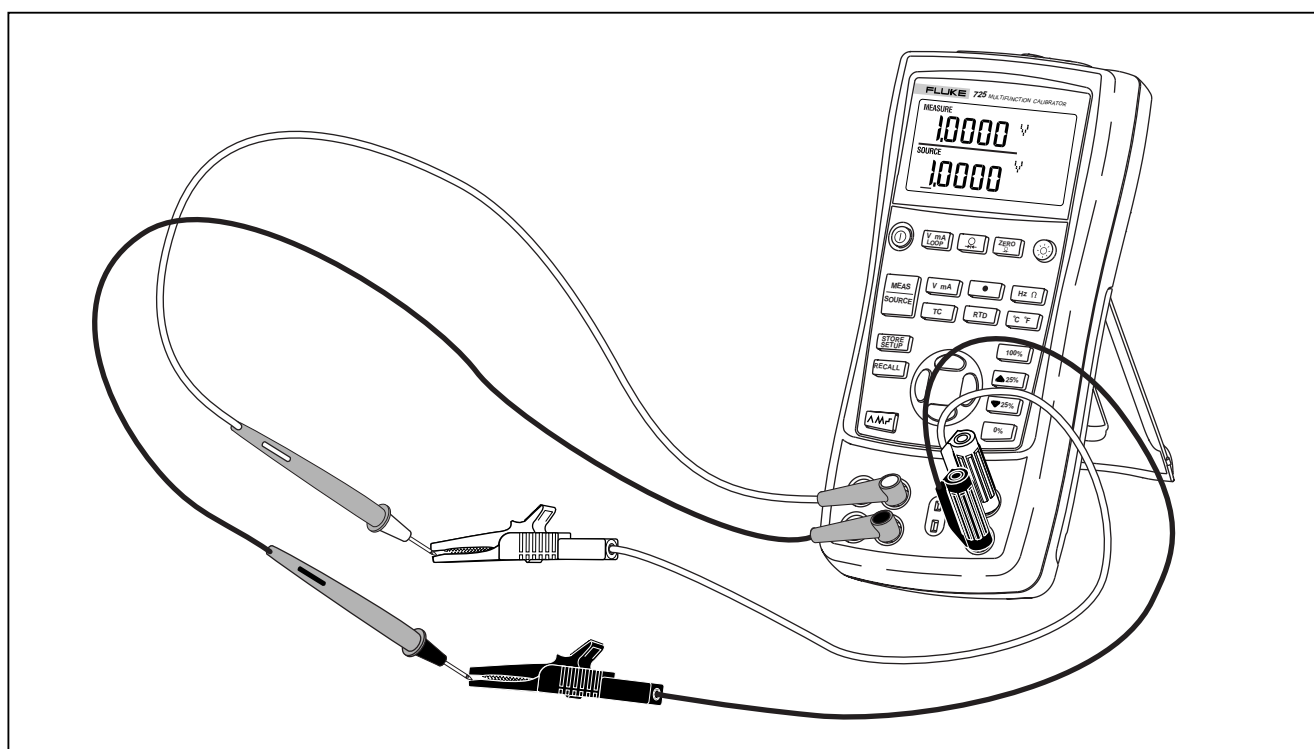

sh39f.eps

Figure 5. Voltage-to-Voltage Test

## Contrast Adjustment

### Note

Available with V2.1 Firmware or greater. To identify firmware version, press and hold **0%** when powering up. The firmware version will be shown in the upper units display for about 1 second after initialization.

To adjust the contrast, proceed as follows:

1. Press **⊙** and **⊕** until Contst Adjust is displayed as shown in Figure 6.
2. Press and hold **▲** to darken contrast.
3. Press and hold **▼** to lighten contrast.
4. Press **STORE SETUP** to save the contrast level.

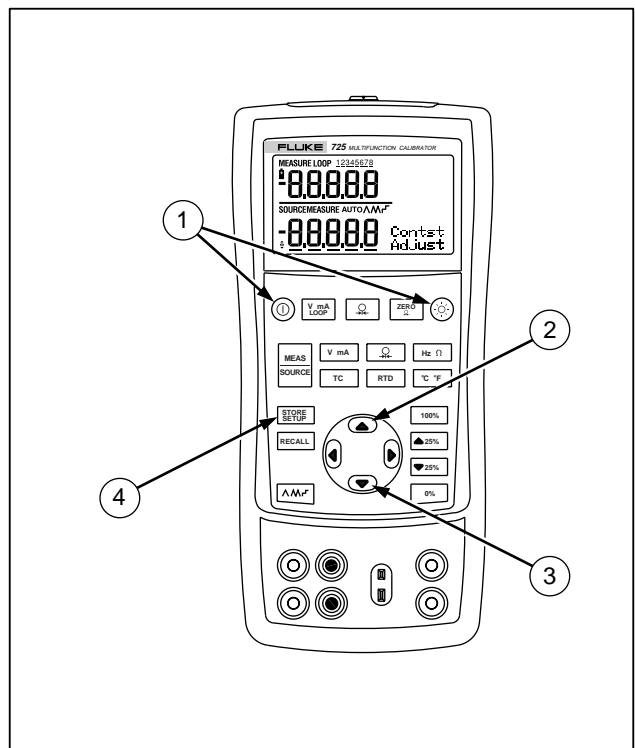

Figure 6. Adjusting the Contrast

sh06f.eps



## Using Measure Mode

### Measuring Electrical Parameters (Upper Display)

To measure the current or voltage output of a transmitter, or to measure the output of a pressure instrument, use the upper display and proceed as follows:

1. Press  $\left[ \begin{array}{c} \text{V mA} \\ \text{LOOP} \end{array} \right]$  to select volts or current. LOOP should not be on.
2. Connect the leads as shown in Figure 7.

### Current Measurement with Loop Power

The loop power function activates a 24 V supply in series with the current measuring circuit, allowing you to test a transmitter when it is disconnected from plant wiring. To measure current with loop power, proceed as follows:

1. Connect the calibrator to the transmitter current loop terminals as shown in Figure 8.
2. Press  $\left[ \begin{array}{c} \text{V mA} \\ \text{LOOP} \end{array} \right]$  while the calibrator is in current measurement mode. LOOP appears and an internal 24 V loop supply turns on.

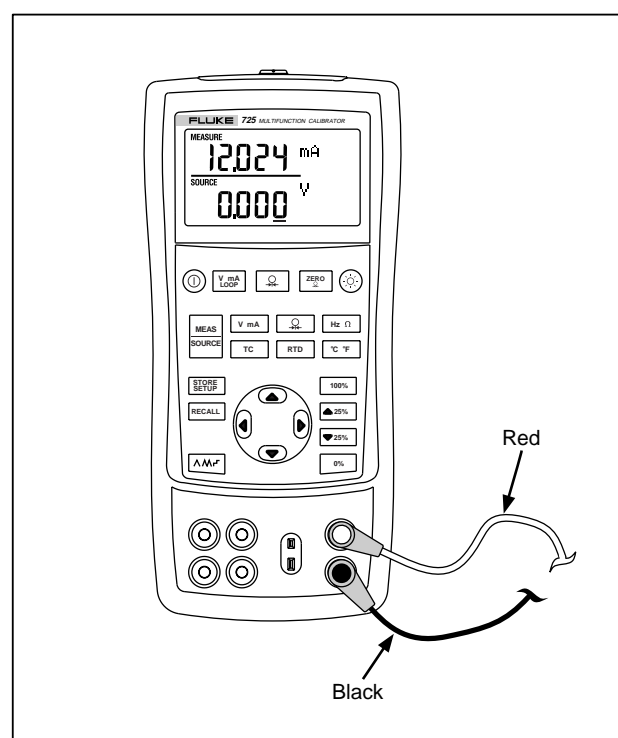

sh42f.eps

Figure 7. Measuring Voltage and Current Output

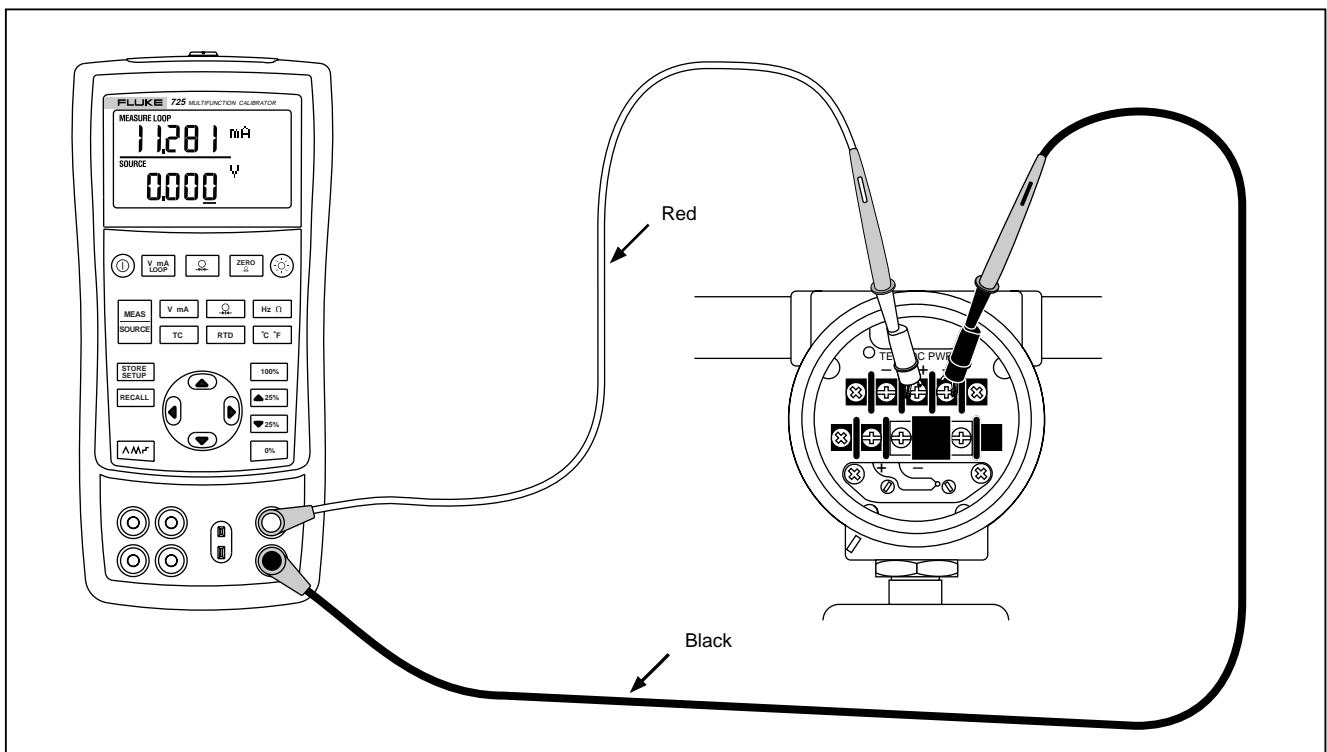





Figure 8. Connections for Supplying Loop Power

sh18f.eps

**Measuring Electrical Parameters (Lower Display)**

To measure the electrical parameters using the lower display, proceed as follows:

1. Connect the calibrator as shown in Figure 9.
2. If necessary, press  for MEASURE mode (lower display)
3. Press  for dc voltage or current, or  for frequency or resistance.

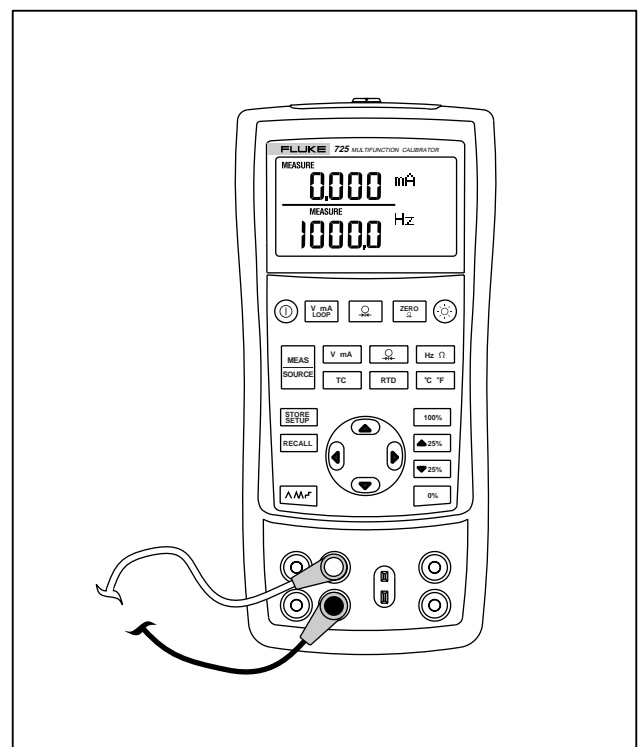

sh43f.eps

**Figure 9. Measuring Electrical Parameters**

## Measuring Temperature

### Using Thermocouples



The calibrator supports ten standard thermocouples, including type E, N, J, K, T, B, R, S, L, or U. Table 5 summarizes the ranges and characteristics of the supported thermocouples.

To measure temperature using a thermocouple, proceed as follows:

1. Attach the thermocouple leads to the appropriate TC miniplug, then to the TC input/output as shown in Figure 10. *One pin is wider than the other. Do not try to force a miniplug in the wrong polarization.*

### Note

*If the calibrator and the thermocouple plug are at different temperatures, wait one minute or more for the connector temperature to stabilize after you plug the miniplug into the TC input/output.*

2. If necessary, press  for MEASURE mode.
3. Press  for the TC display. If desired, continue pressing this key to select the desired thermocouple type.

If necessary, you can toggle between °C or °F temperature units by pressing .

Table 5. Thermocouple Types Accepted

| Type  | Positive Lead Material  | Positive Lead (H) Color |        | Negative Lead Material | Specified Range (°C) |
|---|-------------------------|-------------------------|--------|------------------------|----------------------|
|   |                         | ANSI*                   | IEC**  |                        |                      |
| E   | Chromel                 | Purple                  | Violet | Constantan             | -200 to 950          |
| N   | Ni-Cr-Si                | Orange                  | Pink   | Ni-Si-Mg               | -200 to 1300         |
| J   | Iron                    | White                   | Black  | Constantan             | -200 to 1200         |
| K   | Chromel                 | Yellow                  | Green  | Alumel                 | -200 to 1370         |
| T   | Copper                  | Blue                    | Brown  | Constantan             | -200 to 400          |
| B   | Platinum (30 % Rhodium) | Gray                    |        | Platinum (6 % Rhodium) | 600 to 1800          |
| R   | Platinum (13 % Rhodium) | Black                   | Orange | Platinum               | -20 to 1750          |
| S   | Platinum (10 % Rhodium) | Black                   | Orange | Platinum               | -20 to 1750          |
| L   | Iron                    |                         |        | Constantan             | -200 to 900          |
| U   | Copper                  |                         |        | Constantan             | -200 to 400          |
| *American National Standards Institute (ANSI) device negative lead (L) is always red.       |                         |                         |        |                        |                      |
| **International Electrotechnical Commission (IEC) device negative lead (L) is always white. |                         |                         |        |                        |                      |

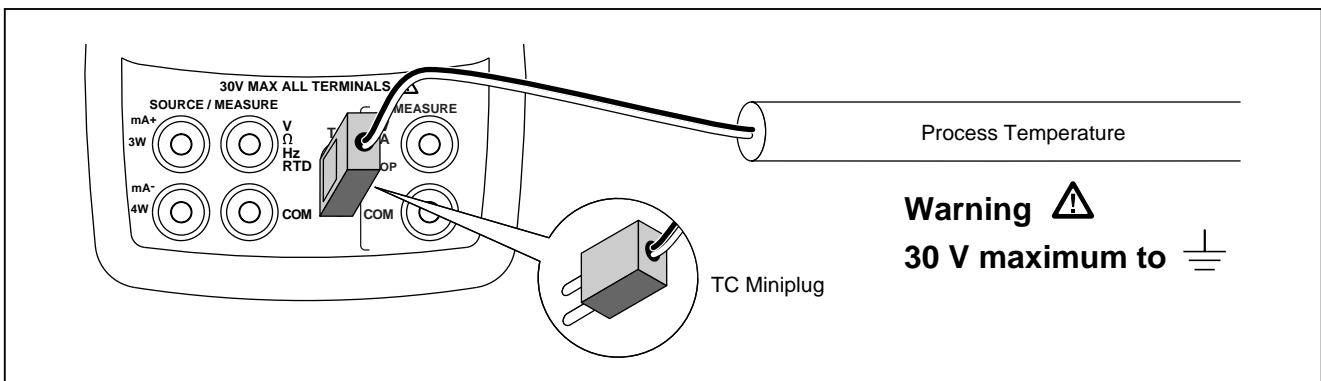

Figure 10. Measuring Temperature with a Thermocouple

sh12f.eps

### Using Resistance-Temperature Detectors (RTDs)

The calibrator accepts RTD types shown in Table 6. RTDs are characterized by their resistance at 0 °C (32 °F), which is called the “ice point” or  $R_0$ . The most common  $R_0$  is 100  $\Omega$ . The calibrator accepts RTD measurement inputs in two-, three-, or four-wire connections, with the three-wire connection the most common. A four-wire configuration provides the highest measurement precision, and two-wire provides the lowest measurement precision.

To measure temperature using an RTD input, proceed as follows:





1. If necessary, press  for MEASURE mode.
2. Press  for the RTD display. If desired, continue pressing this key to select the desired RTD type.
3. Press  or  to select a 2-, 3-, or 4- wire connection.
4. Attach the RTD to input terminals as shown in Figure 11.
5. If necessary, you can toggle between °C or °F temperature units by pressing .

Table 6. RTD Types Accepted

| RTD Type   | Ice Point ( $R_0$ ) | Material | $\alpha$                           | Range ( $^{\circ}\text{C}$ ) |
|--|---------------------|----------|------------------------------------|------------------------------|
| Pt100 (3926)   | 100 $\Omega$        | Platinum | 0.003926 $\Omega/^{\circ}\text{C}$ | -200 to 630                  |
| Pt100 (385)  | 100 $\Omega$        | Platinum | 0.00385 $\Omega/^{\circ}\text{C}$  | -200 to 800                  |
| Ni120 (672)  | 120 $\Omega$        | Nickel   | 0.00672 $\Omega/^{\circ}\text{C}$  | -80 to 260                   |
| Pt200 (385)  | 200 $\Omega$        | Platinum | 0.00385 $\Omega/^{\circ}\text{C}$  | -200 to 630                  |
| Pt500 (385)  | 500 $\Omega$        | Platinum | 0.00385 $\Omega/^{\circ}\text{C}$  | -200 to 630                  |
| Pt1000 (385)   | 1000 $\Omega$       | Platinum | 0.00385 $\Omega/^{\circ}\text{C}$  | -200 to 630                  |
| Pt100 (3916)   | 100 $\Omega$        | Platinum | 0.003916 $\Omega/^{\circ}\text{C}$ | -200 to 630                  |
| The Pt100 commonly used in U.S. industrial applications is Pt100 (3916), $\alpha = 0.003916 \Omega/^{\circ}\text{C}$ . (Also designated as JIS curve.) The IEC standard RTD is the Pt100 (385), $\alpha = 0.00385 \Omega/^{\circ}\text{C}$ . |                     |          |                                    |                              |



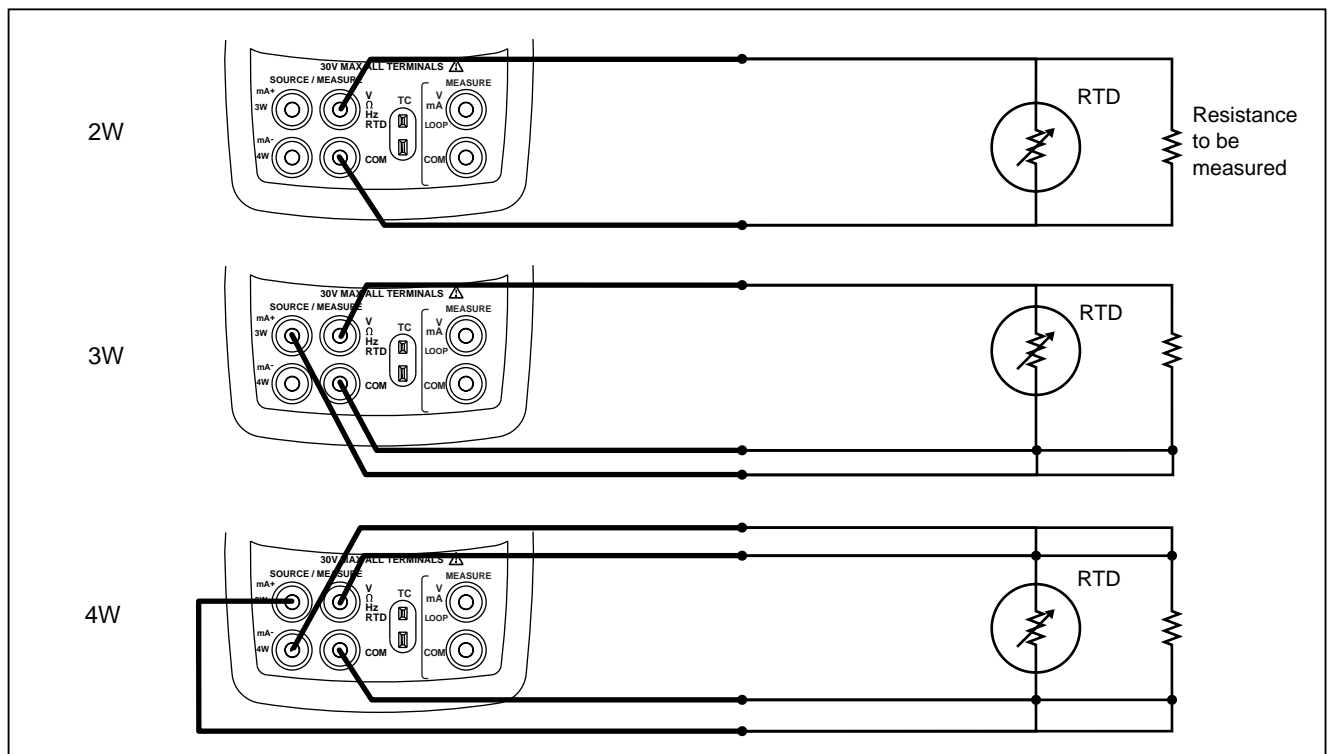

Figure 11. Measuring Temperature with an RTD, Measuring 2-, 3-, and 4-Wire Resistance

sh15f.eps

### Measuring Pressure

Many ranges and types of pressure modules are available from Fluke. See “Accessories” near the back of this manual. Before you use a pressure module, read its instruction sheet. The modules vary in use, media, and accuracy.

Figure 12 shows the gage and differential modules. Differential modules also work in gage mode by leaving the low fitting open to atmosphere.

To measure pressure, attach the appropriate pressure module for the process pressure to be tested

Proceed as follows to measure pressure:

#### **⚠ Warning**

To avoid a violent release of pressure in a pressurized system, shut off the valve and slowly bleed off the pressure before you attach the pressure module to the pressure line.

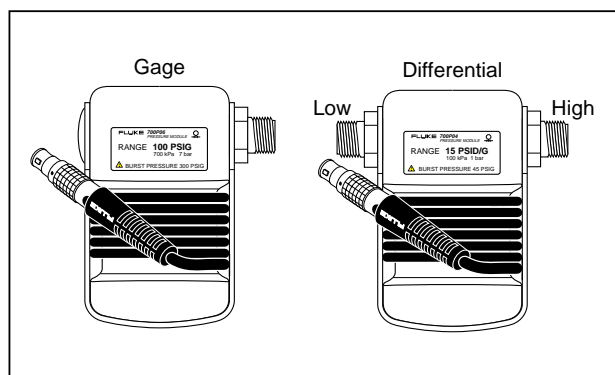

gj11f.eps



Figure 12. Gage and Differential Pressure Modules

#### **Caution**

To avoid mechanically damaging the pressure module, never apply more than 10 ft.-lb. (13.5 Nm) of torque between the pressure module fittings, or between the fittings and the body of the module. Always apply appropriate torque between the pressure module fitting and connecting fittings or adapters.

**To avoid damaging the pressure module from overpressure, never apply pressure above the rated maximum printed on the pressure module.**

**To avoid damaging the pressure module from corrosion, use it only with specified materials. Refer to the printing on the pressure module or the pressure module instruction sheet for the acceptable material compatibility.**





1. Connect a pressure module to the calibrator as shown in Figure 13. The threads on the pressure modules accept standard ¼ NPT pipe fittings. Use the supplied ¼ NPT to ¼ ISO adapter if necessary.
2. Press . The calibrator automatically senses which pressure module is attached and sets its range accordingly.
3. Zero the pressure module as described in the module's Instruction Sheet. Modules vary in zeroing procedures depending on module type, but all require pressing .

If desired, continue pressing  to change pressure display units to psi, mmHg, inHg, cmH<sub>2</sub>O@4 °C,

cmH<sub>2</sub>O@20 °C, inH<sub>2</sub>O@4 °C, inH<sub>2</sub>O@20 °C, mbar, bar, kg/cm<sup>2</sup>, or kPa.

### **Zeroing with Absolute Pressure Modules**

To zero, adjust the calibrator to read a known pressure. This can be barometric pressure, if it is accurately known, for all but the 700PA3 module. The maximum range of 700PA3 is 5 psi; therefore the reference pressure must be applied with a vacuum pump. An accurate pressure standard can also apply a pressure within range for any absolute pressure module. To adjust the calibrator reading, proceed as follows:

1. Press , REF Adjust will appear to the right of the pressure reading.
2. Use  to increase or  to decrease the calibrator reading to equal the reference pressure.
3. Press  again to exit zeroing procedure.

The calibrator stores and automatically reuses the zero offset correction for one absolute pressure module so that the module is not rezeroed every time you use it.

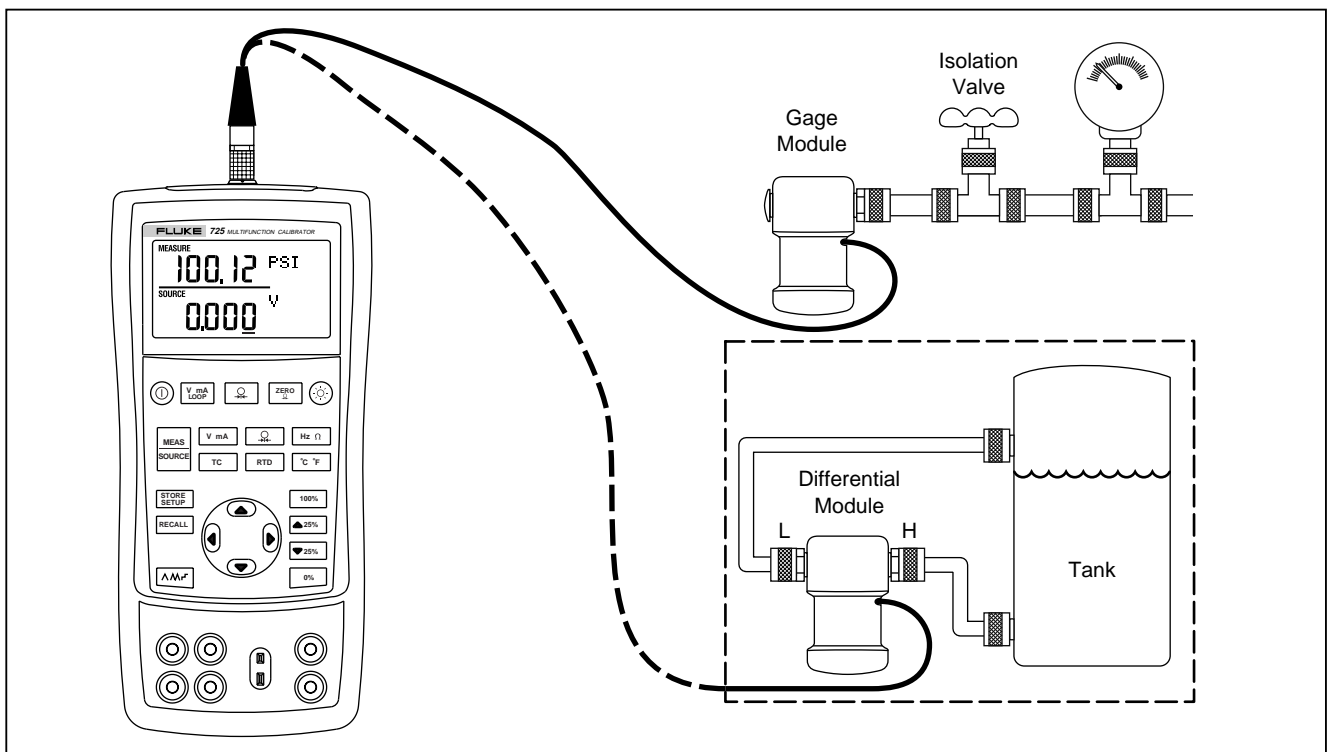

Figure 13. Connections for Measuring Pressure





sh371.eps

## Using Source Mode

In SOURCE mode, the calibrator generates calibrated signals for testing and calibrating process instruments; supplies voltages, currents, frequencies, and resistances; simulates the electrical output of RTD and thermocouple temperature sensors; and measures gas pressure from an external source, creating a calibrated pressure source.

### Sourcing 4 to 20 mA





To select the current sourcing mode, proceed as follows:

1. Connect the test leads in the mA terminals (left column).
2. If necessary, press  for SOURCE mode.
3. Press  for current and enter the desired current you want by pressing  and  keys.

### Simulating a 4- to 20-mA Transmitter

Simulate is a special mode of operation in which the calibrator is connected into a loop in place of a transmitter and supplies a known, settable test current. Proceed as follows:







1. Connect the 24 V loop power source as shown in Figure 14.

2. If necessary, press  for SOURCE mode.
3. Press  until both mA and SIM display.
4. Enter the desired current by pressing  and  keys.

### Sourcing Other Electrical Parameters

Volts, ohms, and frequency are also sourced and shown in the lower display.

To select an electrical sourcing function, proceed as follows:

1. Connect the test leads as shown in Figure 15, depending on the source function.
2. If necessary, press  for SOURCE mode.
3. Press  for dc voltage, or  for frequency or resistance.
4. Enter the desired output value by pressing  and  keys. Press  and  to select a different digit to change.

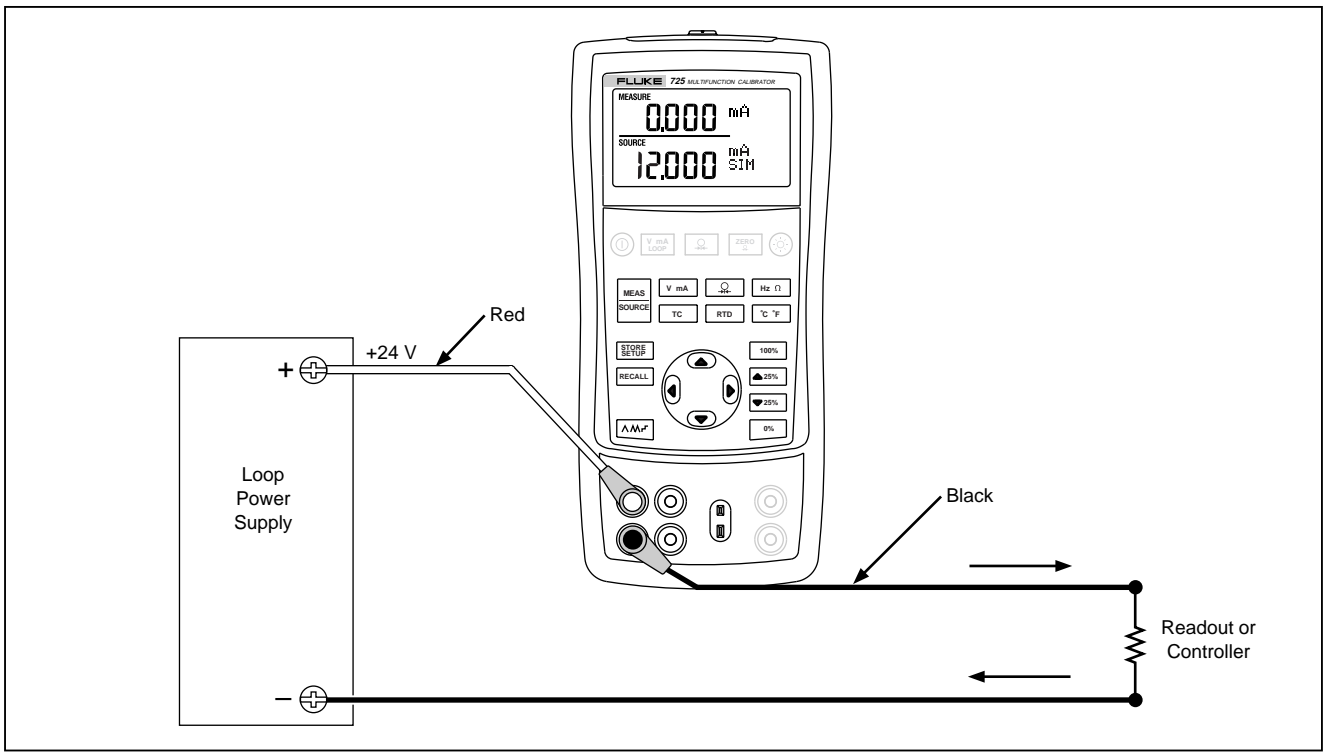

sh17f.eps

Figure 14. Connections for Simulating a 4- to 20-mA Transmitter

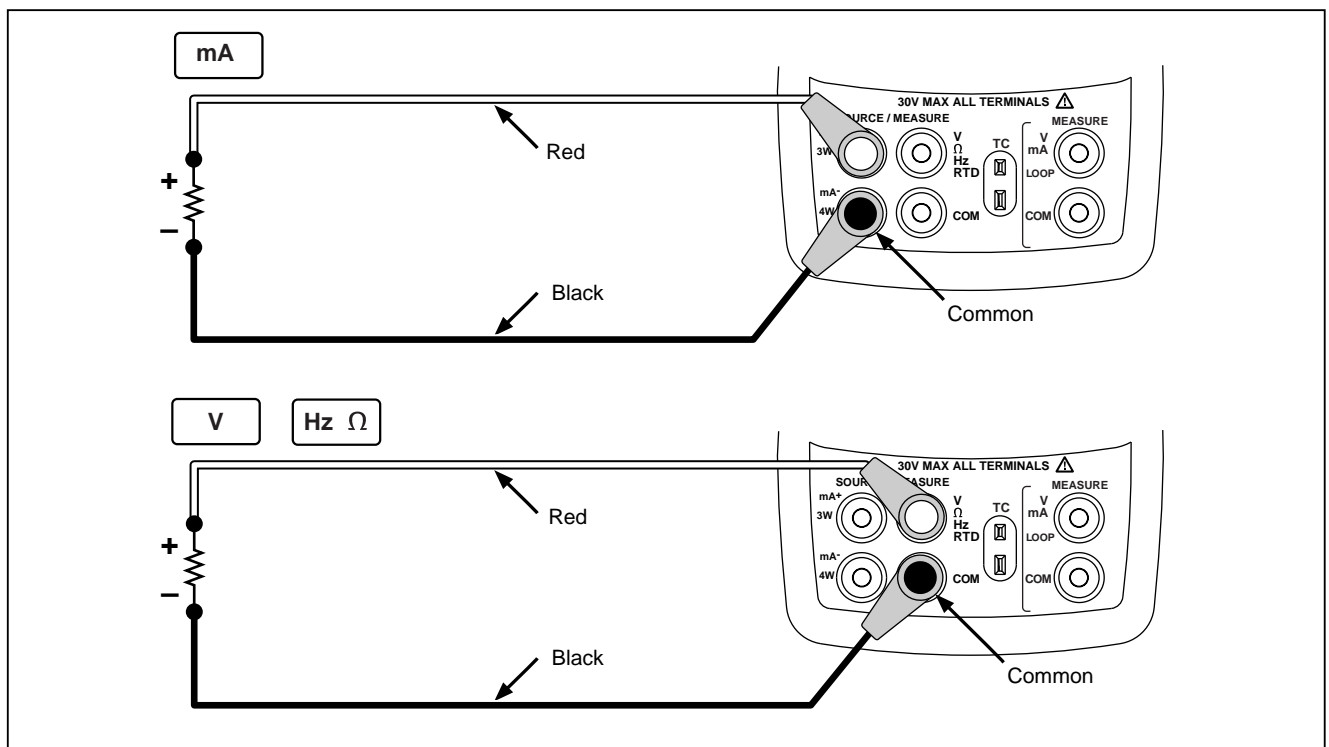







sh16f.eps

Figure 15. Electrical Sourcing Connections

### Simulating Thermocouples

Connect the calibrator TC input/output to the instrument under test with thermocouple wire and the appropriate thermocouple mini-connector (polarized thermocouple plug with flat, in-line blades spaced 7.9 mm [0.312 in] center to center). *One pin is wider than the other. Do not try to force a miniplug in the wrong polarization.* Figure 16 shows this connection. Proceed as follows to simulate a thermocouple:

1. Attach the thermocouple leads to the appropriate TC miniplug, then to the TC input/output as shown in Figure 16.
2. If necessary, press  for SOURCE mode.
3. Press  for the TC display. If desired, continue pressing this key to select the desired thermocouple type.
4. Enter the temperature you want by pressing  and  keys. Press  and  to select a different digit to edit.





### Simulating RTDs

Connect the calibrator to the instrument under test as shown in Figure 17. Proceed as follows to simulate an RTD:

1. If necessary, press  for SOURCE mode.
2. Press  for the RTD display.

#### Note

*Use the 3W and 4W terminals for measurement only, not for simulation. The calibrator simulates a 2-wire RTD at its front panel. To connect to a 3-wire or 4-wire transmitter, use the stacking cables to provide the extra wires. See Figure 17.*

3. Enter the temperature you want by pressing  and  keys. Press  and  to select a different digit to edit.
4. If the 725 display indicates ExI HI, the excitation current from your device under test exceeds the limits of the 725.



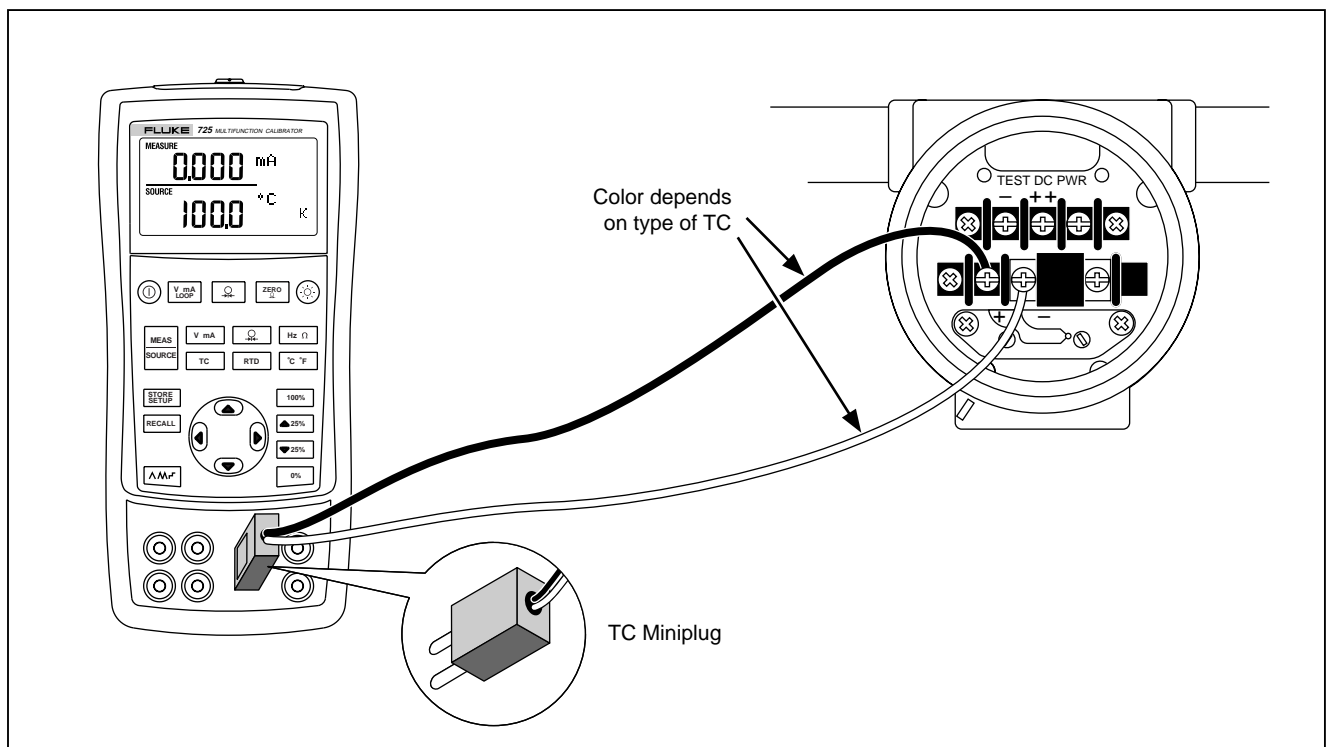
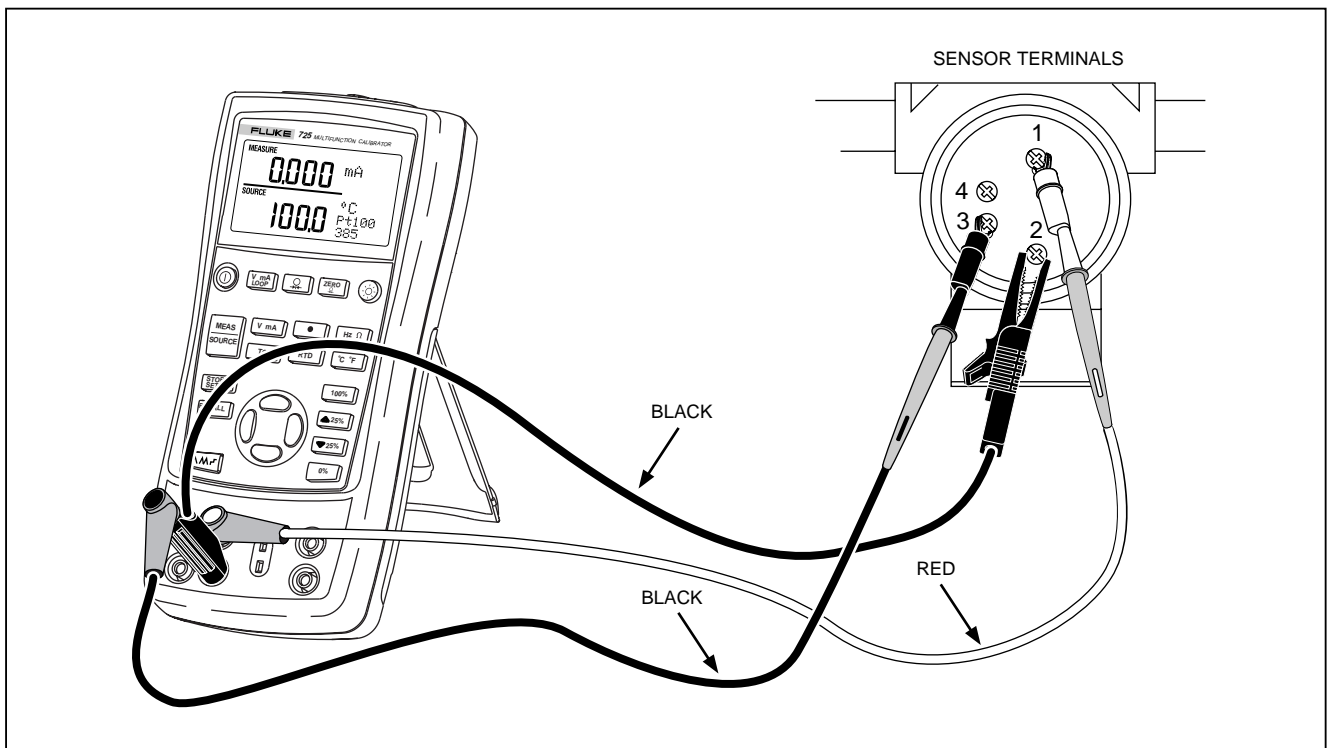

Figure 16. Connections for Simulating a Thermocouple

sh20f.eps



sh40f.eps

Figure 17. Connections for Simulating 3-Wire RTD

### **Sourcing Pressure**

The calibrator sources pressure by measuring pressure supplied by a pump or other sources, and displaying the pressure in the SOURCE field. Figure 20 shows how to connect a pump to a Fluke pressure module which makes it a calibrated source.

Many ranges and types of pressure modules are available from Fluke. See “Accessories” near the back of this manual. Before you use a pressure module, read its Instruction Sheet. The modules vary in use, media, and accuracy.

Attach the appropriate pressure module for the process pressure to be tested.

Proceed as follows to source pressure:

#### **⚠ Warning**

**To avoid a violent release of pressure in a pressurized system, shut off the valve and slowly bleed off the pressure before you attach the pressure module to the pressure line.**

### **Caution**

**To avoid mechanically damaging the pressure module, never apply more than 10 ft.-lb. (13.5 Nm) of torque between the pressure module fittings, or between the fittings and the body of the module. Always apply appropriate torque between the pressure module fitting and connecting fittings or adapters.**

**To avoid damaging the pressure module from overpressure, never apply pressure above the rated maximum printed on the pressure module.**

**To avoid damaging the pressure module from corrosion, use it only with specified materials. Refer to the printing on the pressure module or the pressure module instruction sheet for the acceptable material compatibility.**

## 725

### Users Manual

1. Connect a pressure module to the calibrator as shown in Figure 18. The threads on the pressure modules accept standard ¼ NPT pipe fittings. Use the supplied ¼ NPT to ¼ ISO adapter if necessary.
2. Press  (lower display). The calibrator automatically senses which pressure module is attached and sets its range accordingly.
3. Zero the pressure module as described in the module's Instruction Sheet. Modules vary in zeroing procedures depending on module type.
4. Pressurize the pressure line with the pressure source to the desired level as shown on the display.

If desired, continue pressing  to change pressure display units to psi, mmHg, inHg, cmH<sub>2</sub>O@4 °C, cmH<sub>2</sub>O@20 °C, inH<sub>2</sub>O@4 °C, inH<sub>2</sub>O@20 °C, mbar, bar, kg/cm<sup>2</sup>, or kPa.

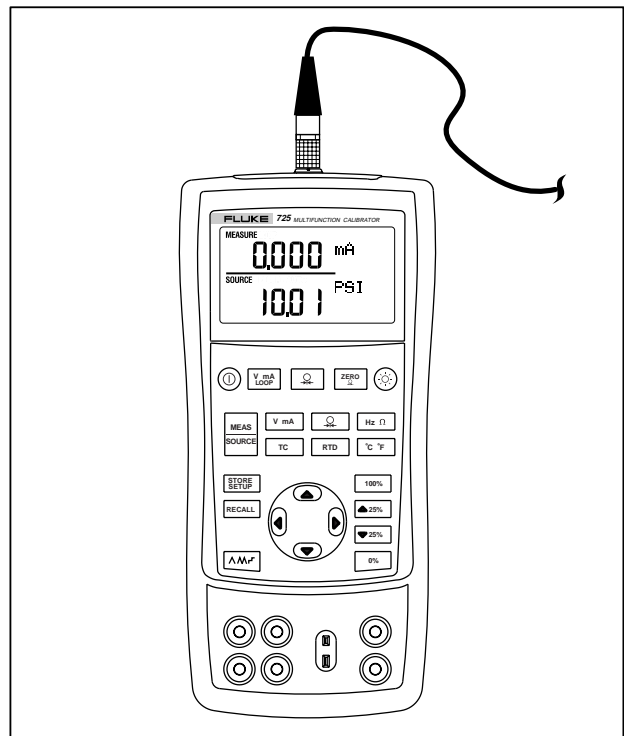



sh19f.eps



Figure 18. Connections for Sourcing Pressure

### Setting 0 % and 100 % Output Parameters

For current output, the calibrator assumes that 0 % corresponds to 4 mA and 100 % corresponds to 20 mA. For other output parameters, you must set the 0 % and 100 % points before you can use the step and ramp functions. Proceed as follows:



1. If necessary, press  for SOURCE mode.
2. Select the desired source function and use the arrow keys to enter the value. Our example is temperature source using 100 °C and 300 °C values for source.
3. Enter 100 °C and press and hold  to store the value.
4. Enter in 300 °C and press and hold  to store the value.

You can now use this setting for the following:

- Manually stepping an output with 25 % increments.
- Jump between the 0 and 100 % span points by momentarily pushing  or .

### Stepping and Ramping the Output





Two features are available for adjusting the value of source functions.

- Stepping the output manually with the  and  keys, or in automatic mode.
- Ramping the output.

Stepping and ramping apply to all functions except pressure, which requires that you use an external pressure source.

### Manually Stepping the mA Output



To manually step current output you can do the following:

- Use  or  to step the current up or down in 25 % steps.
- Touch momentarily either  to go to 0 %, or  to go to 100 %.

### Auto Ramping the Output

Auto ramping gives you the ability to continuously apply a varying stimulus from the calibrator to a transmitter, while your hands remain free to test the response of the transmitter.

When you press , the calibrator produces a continuously repeating 0 % - 100 % - 0 % ramp in your choice of three ramp waveforms:

-  0 % - 100 % - 0 % 40-second smooth ramp
-  0 % - 100 % - 0 % 15-second smooth ramp
-  0 % - 100 % - 0 % Stair-step ramp in 25 % steps, pausing 5 seconds at each step. Steps are listed in Table 7.





To exit ramping, press any button.

**Table 7. mA Step Values**





| Step  | 4 to 20 mA |
|-------|------------|
| 0 %   | 4.000      |
| 25 %  | 8.000      |
| 50 %  | 12.000     |
| 75 %  | 16.000     |
| 100 % | 20.000     |

### Storing and Recalling Setups

You can store up to eight of your settings in a nonvolatile memory and recall the settings for later use. A low battery condition or a battery change does not jeopardize the stored settings. Proceed as follows:

1. After you create a calibrator setup, press . In the display, the memory locations appear.
2. Press  or  to select locations one through eight. An underscore appears below the selected memory location.
3. Press , only the stored memory location will be displayed. The setup is stored.











To recall setups, proceed as follows.

1. Press . The memory locations appear on the display.
2. Press  or  to select the appropriate location and press .

## Calibrating a Transmitter

Use the measurement (upper display) and source (lower display) modes to calibrate a transmitter. This section applies to all but pressure transmitters. The following example shows how to calibrate a temperature transmitter.

Connect the calibrator to the instrument under test as shown in Figure 19. Proceed as follows to calibrate a transmitter

1. Press  for current (upper display). If required, press  again to activate loop power.
2. Press  (lower display). If desired, continue pressing this key to select the desired thermocouple type.
3. If necessary, press  for SOURCE mode.
4. Set your zero and span parameters by pressing  and  keys. Enter these parameters by pressing and holding  and . For more information on setting parameters, see “Setting 0 % and 100 %” earlier in this manual.
5. Perform test checks at 0-25-50-75-100 % points by pressing  or . Adjust the transmitter as necessary.

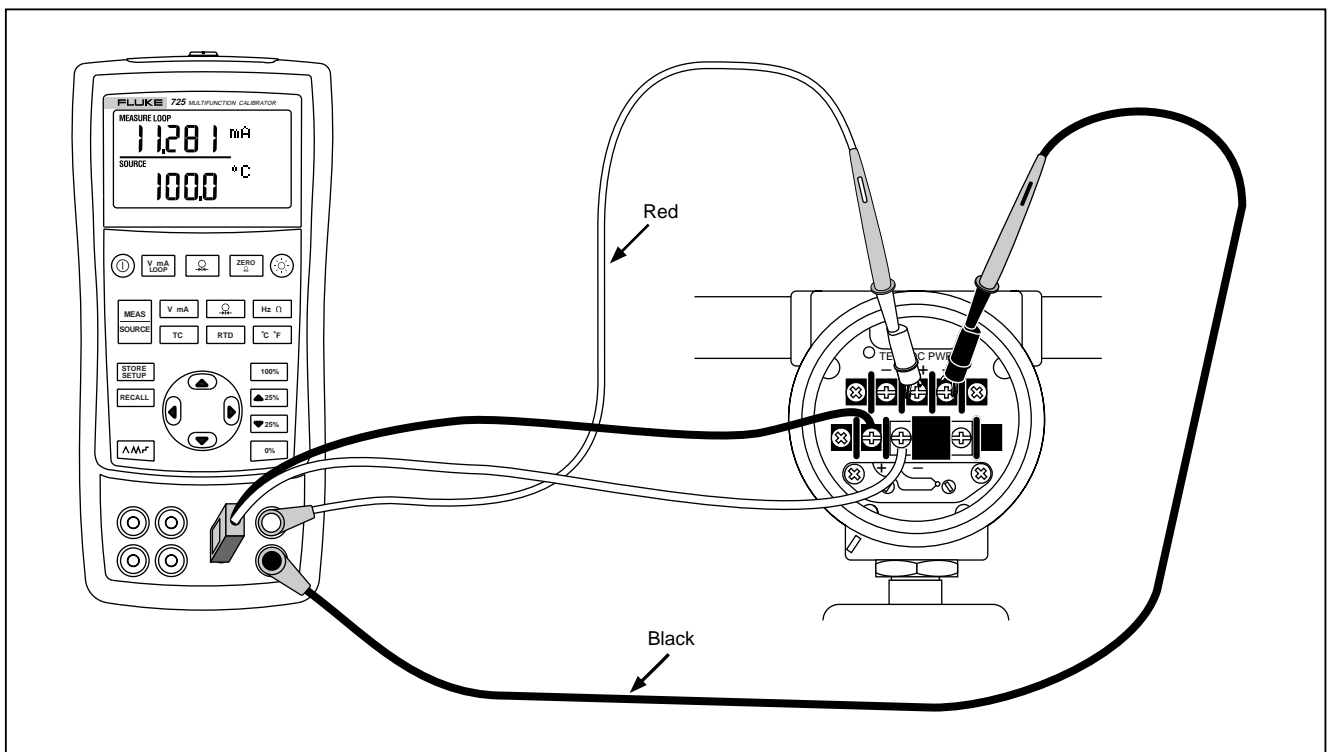

sh44f.eps





Figure 19. Calibrating a Thermocouple Transmitter



### **Calibrating a Pressure Transmitter**

The following example shows how to calibrate a pressure transmitter.

Connect the calibrator to the instrument under test as shown in Figure 20. Proceed as follows:

1. Press  for current (upper display). If required, press  again to activate loop power.
2. Press  (lower display).
3. If necessary, press  for SOURCE mode.
4. Zero the pressure module.
5. Perform checks at 0 % and 100 % of span and adjust the transmitter as necessary.

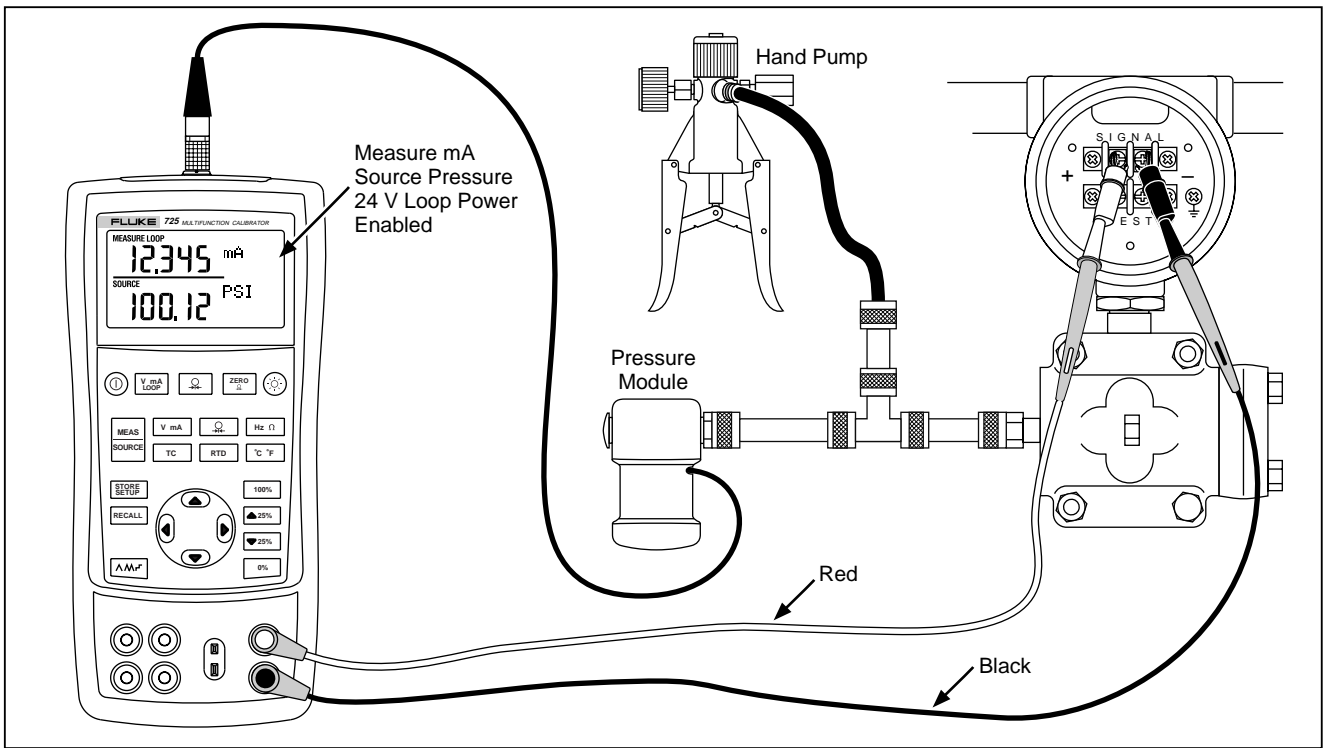









Figure 20. Calibrating a Pressure-to-Current (P/I) Transmitter

sh34f.eps

### Calibrating an I/P Device

The following test allows you to calibrate a device that controls pressure. Proceed as follows:

1. Connect the test leads to the instrument under test as shown in Figure 21. The connections simulate a current-to-pressure transmitter and measures the corresponding output pressure.
2. Press  (upper display).
3. Press  for sourcing current (lower display).
4. If necessary, press  for SOURCE mode.
5. Enter the desired current by pressing  and  keys. Press  and  to select different digits.

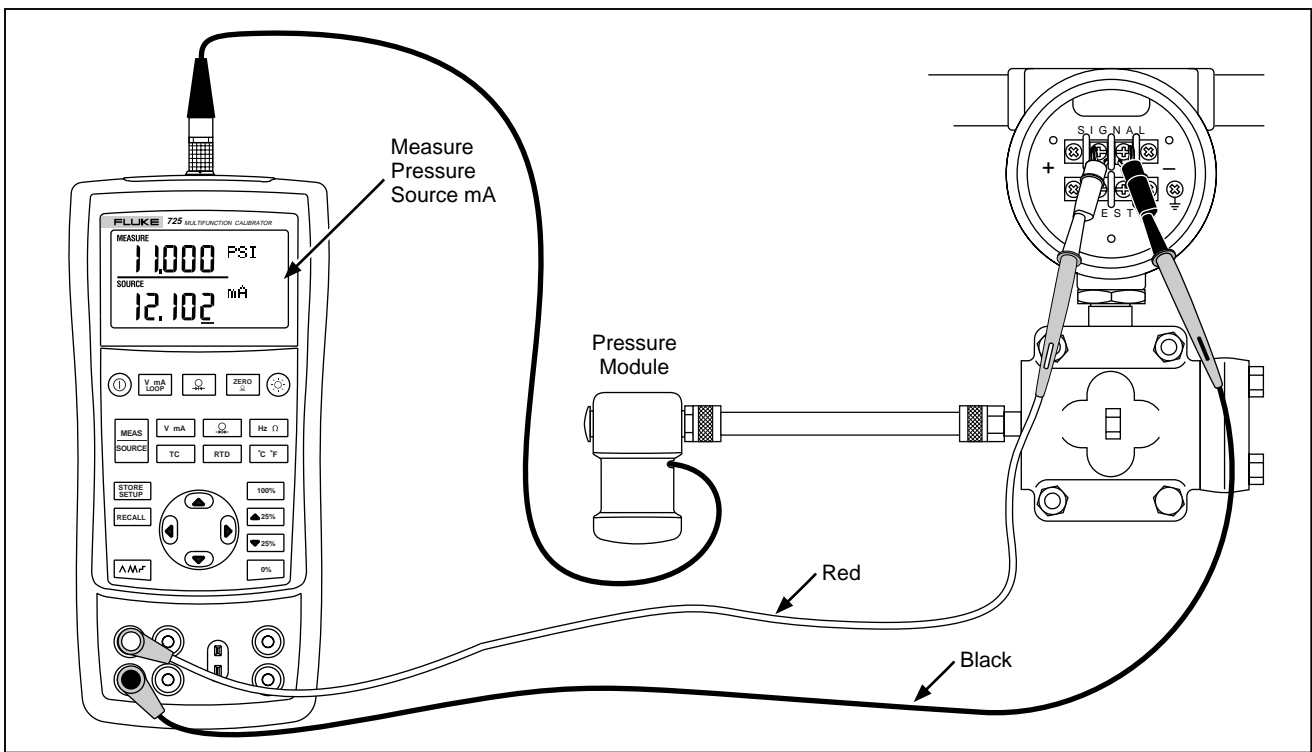

Figure 21. Calibrating a Current-to-Pressure (I/P) Transmitter

sh28f.eps

### Testing an Output Device

Use the source functions to test and calibrate actuators, recording, and indicating devices. Proceed as follows:

1. Connect the test leads to the instrument under test as shown in Figure 22.
2. Press  $\boxed{V \text{ mA}}$  for current or dc voltage, or  $\boxed{Hz \ \Omega}$  for frequency or resistance (lower display).
3. If necessary, press  $\boxed{\text{MEAS SOURCE}}$  for SOURCE mode.

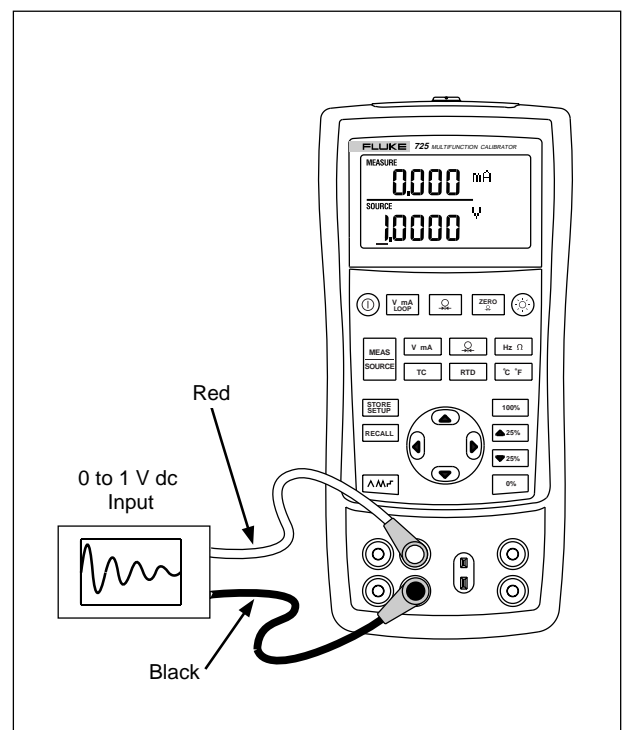

Figure 22. Calibrating a Chart Recorder

sh25f.eps

### Remote Control Commands

You can control the calibrator remotely from a PC running a terminal emulator program. The remote control commands give access to all capabilities of the calibrator with the exception of pressure measurement. See Table 8A-8C for the remote commands and explanations.

The Fluke 700SC Serial Interface Cable Assembly (PN 667425) plugs into the pressure module connector and

terminates in a DB-9 connector which plugs directly into a PC serial port. A DB-9 to DB-25 adapter is required to connect to a PC.

The remote control interface on the 725 is activated by turning the calibrator off, then turning it on again while depressing the  key. The calibrator will initialize with its remote port enabled. The terminal emulator connected to the calibrator should be set up for: 9600 baud, no parity, 8 data bits, and 1 stop bit.

**Table 8A. Remote Control Upper Display**

| Serial Input | Description   |
|--------------|---|
| j            | mA measurement  |
| L            | mA Loop Power   |
| E            | Volts measurement   |
| B            | Single broadcast of most recent upper display value and units |

**Table 8B. Remote Control Lower Display**

| Serial Input | Description       |
|--------------|-------------------|
| A            | mA measurement    |
| a            | mA source         |
| l            | mA 2W Sim         |
| V            | Volts measurement |
| v            | Volts source      |
| M            | mV measurement    |
| m            | mV source         |
| K            | KHz measurement   |

Table 8B. Remote Control Lower Display (cont)

| Serial Input | Description   |
|--------------|---|
| k            | KHz source  |
| H            | Hz measurement  |
| h            | Hz source   |
| P            | CPM measurement   |
| p            | CPM source  |
| O            | Ohms measurement (default 2W)   |
| o            | Select Ohms source  |
| W            | 2-wire measurement (Ohms and RTDs)  |
| X            | 3-wire measurement (Ohms and RTDs)  |
| Y            | 4-wire measurement (Ohms and RTDs)  |
| T            | Thermocouple measurement (default Type J) use "S" command to select sensor type |
| t            | Thermocouple source (default Type J) use "S" command to select sensor type      |
| C            | Selects Centigrade ( T/C-RTD)   |
| F            | Selects Fahrenheit ( T/C-RTD)   |
| R            | RTD measurement mode (default Pt100 385) use "S" command to select sensor type  |
| r            | RTD measurement mode (default Pt100 385) use "S" command to select sensor type  |
| u            | Increment display source value  |
| d            | Decrement display source value  |
| <            | The < arrow key PC keyboard selects left arrow on 725                           |
| >            | The > arrow key PC keyboard selects right arrow on 725                          |

Table 8B. Remote Control Lower Display (cont)

| Serial Input         | Description   |
|----------------------|---|
| 0-9<br>- , .<br><CR> | Enter a source value using ascii characters 0,1,2,...9,-,.,terminated by <CR> (carriage return) |
| b                    | Single Broadcast of most recent lower display value and units                                   |

Table 8C. "S" Commands Select Sensor Type

| Serial Input | Selection Entry |                   | RTD Type     |
|--------------|-----------------|-------------------|--------------|
|              | No.             | Thermocouple Type |              |
| S            | 1               | J                 | Pt100 (3926) |
|              | 2               | K                 | Pt100 (385)  |
|              | 3               | T                 | Pt100 (3916) |
|              | 4               | E                 | Pt200 (385)  |
|              | 5               | R                 | Pt500 (385)  |
|              | 6               | S                 | Pt1000 (385) |
|              | 7               | B                 | Ni120        |
|              | 8               | L                 |              |
|              | 9               | U                 |              |
|              | A               | N                 |              |
|              | B               | mV                |              |



## Replacing the Batteries

### **⚠ Warning**

**To avoid false readings, which could lead to possible electric shock or personal injury, replace the batteries as soon as the battery indicator (🔋) appears.**

Figure 23 shows you how to replace the battery.

## Replacing the Fuses

The calibrator comes equipped with two 0.05A, 250V, socketed fuses to protect the calibrator.

### **⚠ Warning**

**To avoid electrical shock, remove the test leads from the calibrator before opening the battery door. Close and latch the battery door before using the calibrator.**

The fuses can be removed and checked for resistance. A value of  $< 10 \Omega$  is good. Problems while measuring using the right jacks indicate that F3 may have opened. If you can't measure or source current with the left jacks, F4 may have opened. To replace the fuses, refer to Figure 23 and perform the following steps:

1. Turn the calibrator off, remove the test leads from the terminals, and hold the calibrator face down.
2. Using a flat-blade screwdriver, turn the battery door screws 1/4-turn counterclockwise and remove the battery door.
3. Remove and replace the damaged fuse.
4. Replace the battery door and secure it by turning the screws 1/4-turn clockwise.

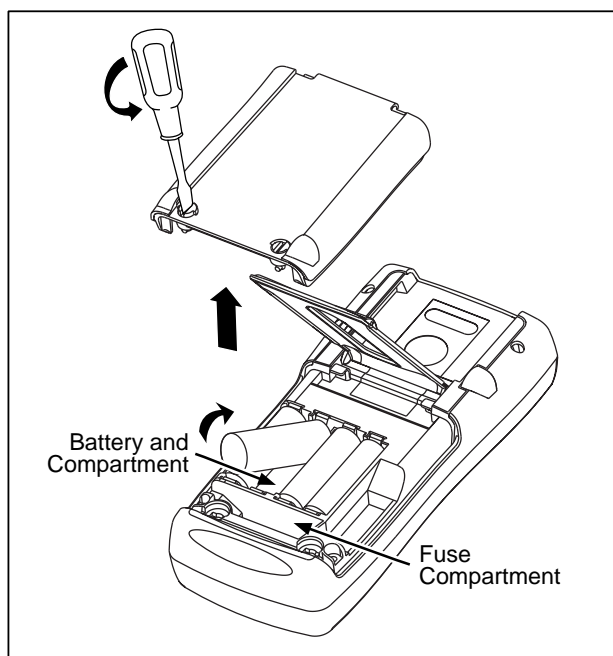

Figure 23. Replacing the Batteries

## Maintenance

### Cleaning the Calibrator

#### Warning

To avoid personal injury or damage to the calibrator, use only the specified replacement parts and do not allow water into the case.

#### Caution

To avoid damaging the plastic lens and case, do not use solvents or abrasive cleansers.

Clean the calibrator and pressure modules with a soft cloth dampened with water or water and mild soap.

### Service Center Calibration or Repair

Calibration, repairs, or servicing not covered in this manual should be performed only by qualified service personnel. If the calibrator fails, check the batteries first, and replace them if needed.

Verify that the calibrator is being operated in accordance with the instructions in this manual. If the calibrator is faulty, send a description of the failure with the calibrator. Pressure modules do not need to accompany the calibrator unless the module is faulty also. Be sure to

pack the calibrator securely, using the original shipping container if it is available. Send the equipment postage paid and insured, to the nearest Service Center. Fluke assumes no responsibility for damage in transit.

The Fluke 725 calibrator covered by the warranty will be promptly repaired or replaced (at Fluke's option) and returned to you at no charge. See the back of the title page for warranty terms. If the warranty period has expired, the calibrator will be repaired and returned for a fixed fee. If the calibrator or pressure module is not covered under the warranty terms, contact an authorized service center for a price quote for repair.

### Replacement Parts

Table 9 lists the part number of each replaceable part. Refer to Figure 24.

**Table 9. Replacement Parts**

| Item | Description          | PN     | Qty. |
|------|----------------------|--------|------|
| 1    | Case top             | 664232 | 1    |
| 2    | LCD mask             | 664273 | 1    |
| 3    | Elastomeric strips   | 802063 | 2    |
| 4    | Input/output bracket | 691391 | 1    |
| 5    | LCD bracket          | 667287 | 1    |

|    |                                    |         |    |
|----|------------------------------------|---------|----|
| 6  | Mounting screws                    | 494641  | 11 |
| 7  | Backlight                          | 690336  | 1  |
| 8  | LCD                                | 690963  | 1  |
| 9  | Keypad                             | 690955  | 1  |
| 10 | Case bottom                        | 664235  | 1  |
| 11 | AA alkaline batteries              | 376756  | 4  |
| 12 | Case screws                        | 832246  | 4  |
| 13 | Battery door                       | 664250  | 1  |
| 14 | Accessory mount                    | 658424  | 1  |
| 15 | Tilt stand                         | 659026  | 1  |
| 16 | Battery door 1/4-turn fasteners    | 948609  | 2  |
| 17 | TL75 series test leads             | 855742  | 1  |
| 18 | Test lead, red                     | 688051  | 1  |
|    | Test lead, black                   | 688066  | 1  |
| 19 | <i>725 Product Overview Manual</i> | 1549644 | 1  |
| 20 | AC72 alligator clip, red           | 1670641 | 1  |
|    | AC72 alligator clip, black         | 1670652 | 1  |
| 21 | CD ROM, contains User Manual       | 1549615 | 1  |
| 22 | Input Decal                        | 690948  | 1  |
| 23 | Fuse 0.05A/250V                    | 2002234 | 2  |

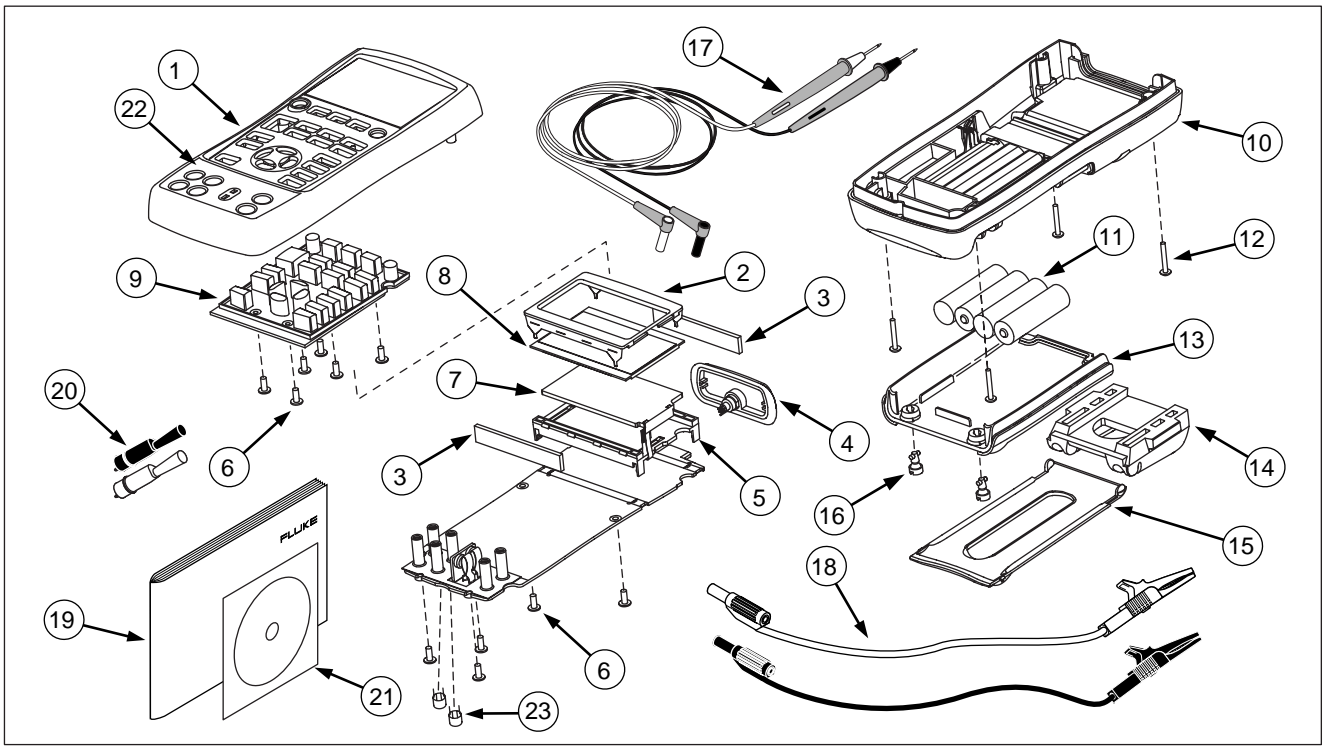

Figure 24. Replacement Parts

zi45f.eps

## Accessories

For more information about these accessories and their prices, contact your Fluke representative. Pressure Modules and Fluke model numbers (see Table 10) are listed below. (Differential models also operate in gage mode.) Contact your Fluke representative about new pressure modules not listed here.

- 700HTP 0 to 10,000 PSI Pump
- 700PTP -11.6 to 360 PSI Pump
- 700TC1 and 700TC2 Thermocouple Mini-plug Kits

## External Fluke Pressure Module Compatibility

The output of Fluke 700P pressure modules can cause the 725's 5 digit display to overflow, or else produce values that are too low to be read if inappropriate units are selected. This is prevented by displaying OL on the display per the following table.

**Table 10. Fluke Pressure Module Compatibility**

| Pressure Unit        | Module Compatibility             |
|----------------------|----------------------------------|
| Psi                  | Available on all pressure ranges |
| In. H <sub>2</sub> O | All ranges through 3000 psi      |
| cm. H <sub>2</sub> O | All ranges through 1000 psi      |
| Bar                  | 15 psi and above                 |
| Mbar                 | All ranges through 1000 psi      |
| KPa                  | Available on all pressure ranges |
| In.Hg.               | Available on all pressure ranges |
| mm. Hg               | All ranges through 1000 psi      |
| Kg/cm <sup>2</sup>   | 15 psi and above                 |

Table 11. Pressure Modules

| Fluke Model Number | Range                     | Type and Media    |
|--------------------|---------------------------|-------------------|
| Fluke-700P00       | 0 to 1" H <sub>2</sub> O  | differential, dry |
| Fluke-700P01       | 0 to 10" H <sub>2</sub> O | differential, dry |
| Fluke-700P02       | 0 to 1 psi                | differential, dry |
| Fluke-700P22       | 0 to 1 psi                | differential, wet |
| Fluke-700P03       | 0 to 5 psi                | differential, dry |
| Fluke-700P23       | 0 to 5 psi                | differential, wet |
| Fluke-700P04       | 0 to 15 psi               | differential, dry |
| Fluke-700P24       | 0 to 15 psi               | differential, wet |
| Fluke-700P05       | 0 to 30 psi               | gage, wet         |
| Fluke-700P06       | 0 to 100 psi              | gage, wet         |
| Fluke-700P27       | 0 to 300 psi              | gage, wet         |
| Fluke-700P07       | 0 to 500 psi              | gage, wet         |
| Fluke-700P08       | 0 to 1,000 psi            | gage, wet         |
| Fluke-700P09       | 0 to 1,500 psi            | gage, wet         |

Table 11. Pressure Modules (cont.)

| Fluke Model Number | Range           | Type and Media  |
|--------------------|-----------------|-----------------|
| Fluke-700P29       | 0 to 3,000 psi  | gage, wet       |
| Fluke-700P30       | 0 to 5,000 psi  | gage, wet       |
| Fluke-700P31       | 0 to 10,000 psi | gage, wet       |
| Fluke-700PA3       | 0 to 5 psi      | absolute, wet   |
| Fluke-700PA4       | 0 to 15 psi     | absolute, wet   |
| Fluke-700PA5       | 0 to 30 psi     | absolute, wet   |
| Fluke-700PA6       | 0 to 100 psi    | absolute, wet   |
| Fluke-700PV3       | 0 to -5 psi     | vacuum, dry     |
| Fluke-700PV4       | 0 to -15 psi    | vacuum, dry     |
| Fluke-700PD2       | ±1 psi          | dual range, dry |
| Fluke-700PD3       | ±5 psi          | dual range, dry |
| Fluke-700PD4       | ±15 psi         | dual range, dry |
| Fluke-700PD5       | -15/+30 psi     | dual range, wet |
| Fluke-700PD6       | -15/+100 psi    | dual range, wet |
| Fluke-700PD7       | -15/+200 psi    | dual range, wet |

## Specifications

Specifications are based on a one year calibration cycle and apply from +18 °C to +28 °C unless stated otherwise. All specifications assume a 5 minute warmup period.

### DC Voltage Measurement

| Range   | Resolution | Accuracy,<br>(% of Reading + Counts) |
|---|------------|--------------------------------------|
| 30 V<br>(upper display)   | 0.001 V    | 0.02 % + 2                           |
| 20 V<br>(lower display)   | 0.001 V    | 0.02 % + 2                           |
| 90 mV   | 0.01 mV    | 0.02 % + 2                           |
| <b>Temperature coefficient -10 °C to 18 °C, +28 °C to 55 °C: ±0.005 % of range per °C</b> |            |                                      |

### DC Voltage Source

| Range   | Resolution | Accuracy,<br>(% of Reading + Counts) |
|---|------------|--------------------------------------|
| 100 mV  | 0.01 mV    | 0.02 % + 2                           |
| 10 V  | 0.001 V    | 0.02 % + 2                           |
| <b>Temperature coefficient -10 °C to 18 °C, +28 °C to 55 °C: ±0.005 % of range per °C</b> |            |                                      |
| <b>Maximum load: 1 mA</b>   |            |                                      |

### Millivolt Measurement and Source\*

| Range  | Resolution | Accuracy             |
|--|------------|----------------------|
| -10 mV to 75 mV  | 0.01 mV    | ±(0.025 % + 1 count) |
| <b>Maximum input voltage: 30 V</b>   |            |                      |
| <b>Temperature coefficient -10 °C to 18 °C, +28 °C to 55 °C: ±0.005 % of range per °C</b>  |            |                      |
| *Select this function by pressing <input type="checkbox"/> <b>TC</b> . The signal is available at the thermocouple miniplug connector. |            |                      |



**DC mA Measurement and Source**

| Range   | Resolution | Accuracy,<br>(% of Reading + Counts) |
|---|------------|--------------------------------------|
| 24 mA   | 0.001 mA   | 0.02 % + 2                           |
| <b>Temperature coefficient -10 °C to 18 °C, +28 °C to 55 °C: ±0.005 % of range per °C</b><br><b>Drive capability: 1000 Ω at 20 mA</b> |            |                                      |

**Ohms Measurement**

| Ohms Range  | Accuracy ± Ω* |               |
|---|---------------|---------------|
|   | 4-Wire        | 2- and 3-Wire |
| 0 to 400 Ω  | 0.1           | 0.15          |
| 400 to 1.5 kΩ   | 0.5           | 1.0           |
| 1.5 to 3.2 kΩ   | 1             | 1.5           |
| <b>Temperature coefficient -10 °C to 18 °C, +28 °C to 55 °C: ±0.005 % of range per °C</b><br><b>Excitation Current: 0.2 mA</b><br><b>Maximum input voltage: 30 V</b><br>* 2-wire: Does not include lead resistance.<br>3-wire: Assumes matched leads with a total resistance not exceeding 100 Ω. |               |               |

**Ohms Source**

| Ohms Range  | Excitation Current from<br>Measurement Device | Accuracy<br>± Ω |
|---|---|-----------------|
| 15 to 400 Ω   | 0.15 to 0.5 mA                                | 0.15            |
| 15 to 400 Ω   | 0.5 to 2 mA                                   | 0.1             |
| 400 to 1.5 kΩ   | 0.05 to 0.8 mA                                | 0.5             |
| 1.5 to 3.2 kΩ   | 0.05 to 0.4 mA                                | 1               |
| <b>Temperature coefficient -10 °C to 18 °C, +28 °C to 55 °C: ± 0.005 % of resistance range per °C</b> |   |                 |
| Resolution  |   |                 |
| 15 to 400 Ω   | 0.1 Ω   |                 |
| 400 to 3.2 kΩ   | 1 Ω   |                 |

**Frequency Measurement**

| Range  | Resolution | Accuracy             |
|--|------------|----------------------|
| 2.0 to 1000.0 CPM  | 0.1 CPM    | ± (0.05 % + 1 count) |
| 1 to 1000 Hz   | 0.1 Hz     | ± (0.05 % + 1 count) |
| 1.0 to 10.0 kHz  | 0.01 kHz   | ± (0.05 % + 1 count) |
| <b>Sensitivity: 1V peak-to-peak minimum</b><br><b>Waveform: squarewave</b> |            |                      |

**Frequency Source**

| Range  | Resolution | Accuracy<br>(% of output<br>frequency) |
|--|------------|--|
| 2.0 to 1000.0 CPM                                  | 0.1 CPM    | ± 0.05 %                               |
| 1 to 1000 Hz                                       | 1 Hz       | ± 0.05 %                               |
| 1.0 to 10.0 kHz                                    | 0.1 kHz    | ± 0.25 %                               |
| <b>Waveform:</b> 5 V p-p squarewave, -0.1 V offset |            |  |

**Temperature, Thermocouples**

| Type | Range          | Measure and Source<br>Accuracies (ITS-90) |
|------|----------------|---|
| J    | -200 to 0 °C   | 1.0 °C                                    |
|      | 0 to 1200 °C   | 0.7 °C                                    |
| K    | -200 to 0 °C   | 1.2 °C                                    |
|      | 0 to 1370 °C   | 0.8 °C                                    |
| T    | -200 to 0 °C   | 1.2 °C                                    |
|      | 0 to 400 °C    | 0.8 °C                                    |
| E    | -200 to 0 °C   | 0.9 °C                                    |
|      | 0 to 950 °C    | 0.7 °C                                    |
| R    | -20 to 0 °C    | 2.5 °C                                    |
|      | 0 to 500 °C    | 1.8 °C                                    |
|      | 500 to 1750 °C | 1.4 °C                                    |
| S    | -20 to 0 °C    | 2.5 °C                                    |
|      | 0 to 500 °C    | 1.8 °C                                    |
|      | 500 to 1750 °C | 1.5 °C                                    |

|                              |                 |                |
|------------------------------|-----------------|----------------|
| B                            | 600 to 800 °C   | 2.2 °C         |
|                              | 800 to 1000 °C  | 1.8 °C         |
|                              | 1000 to 1800 °C | 1.4 °C         |
| L                            | -200 to 0 °C    | 0.85 °C        |
|                              | 0 to 900 °C     | 0.7 °C         |
| U                            | -200 to 0 °C    | 1.1 °C         |
|                              | 0 to 400 °C     | 0.75 °C        |
| N                            | -200 to 0 °C    | 1.5 °C         |
|                              | 0 to 1300 °C    | 0.9 °C         |
| XK                           | -200 to -100 °C | 0.5 °C         |
|                              | -100 to 800 °C  | 0.6 °C         |
| BP                           | 0 to 800 °C     | 1.2 °C         |
|                              | 800 to 2500 °C  | 2.5 °C         |
| <b>Resolution:</b>           |                 |                |
| J, K, T, E, L, N, U, XK, BP: |                 | 0.1 °C, 0.1 °F |
| B, R, S:                     |                 | 1 °C, 1 °F     |

**Loop Power Supply**

Voltage: 24 V

Maximum current: 22 mA

Short circuit protected

**RTD Excitation (simulation)**

| Allowable Excitation by RTD type |                 |
|----------------------------------|-----------------|
| Ni 120                           | 0.15 to 3.0 mA  |
| Pt 100-385                       | 0.15 to 3.0 mA  |
| Pt 100-392                       | 0.15 to 3.0 mA  |
| Pt 100-JIS                       | 0.15 to 3.0 mA  |
| Pt 200-385                       | 0.15 to 3.0 mA  |
| Pt 500-385                       | 0.05 to 0.80 mA |
| Pt 1000-385                      | 0.05 to 0.40 mA |

**Temperature, RTD Ranges, and Accuracies (ITS-90)**

| Type       | Range °C    | Accuracy          |                           |           |
|------------|-------------|-------------------|---------------------------|-----------|
|            |             | Measure 4-Wire °C | Measure 2- and 3-Wire* °C | Source °C |
| Ni120      | -80 to 260  | 0.2               | 0.3                       | 0.2       |
| Pt100-385  | -200 to 800 | 0.33              | 0.5                       | 0.33      |
| Pt100-392  | -200 to 630 | 0.3               | 0.5                       | 0.3       |
| Pt100-JIS  | -200 to 630 | 0.3               | 0.5                       | 0.3       |
| Pt200-385  | -200 to 250 | 0.2               | 0.3                       | 0.2       |
|            | 250 to 630  | 0.8               | 1.6                       | 0.8       |
| Pt500-385  | -200 to 500 | 0.3               | 0.6                       | 0.3       |
|            | 500 to 630  | 0.4               | 0.9                       | 0.4       |
| Pt1000-385 | -200 to 100 | 0.2               | 0.4                       | 0.2       |
|            | 100 to 630  | 0.2               | 0.5                       | 0.2       |

**Resolution:** 0.1 °C, 0.1 °F**Allowable excitation current (source):** Ni120, Pt100-385, Pt100-392, Pt100-JIS, Pt200-385: 0.15 to 3.0 mA

Pt500-385: 0.05 to 0.80 mA; Pt1000-385: 0.05 to 0.40 mA

**RTD Source:** Addresses pulsed transmitters and PLCs with pulses as short as 5 ms.

\* 2-wire: Does not include lead resistance.

3-wire: Assumes matched leads with a total resistance not exceeding 100 Ω.

**Pressure Measurement**

| Range                         | Resolution | Accuracy                      | Units  |
|-------------------------------|------------|-------------------------------|--|
| Determined by pressure module | 5 digits   | Determined by pressure module | psi, inH <sub>2</sub> O@4 °C, inH <sub>2</sub> O@20 °C, kPa, cmH <sub>2</sub> O@4 °C, cmH <sub>2</sub> O@20 °C, bar, mbar, kg/cm <sub>2</sub> , mmHg, inHg |

**General Specifications**

|   |  |
|---|--|
| Operating temperature                                   | -10 °C to 55 °C  |
| Storage temperature                                     | - 20 °C to 71 °C   |
| Operating altitude                                      | 3000 meters above mean sea level   |
| Relative Humidity (% RH operating without condensation) | 90 % (10 to 30 °C)<br>75 % (30 to 40 °C)<br>45 % (40 to 50 °C)<br>35 % (50 to 55 °C)<br>uncontrolled < 10 °C |
| Vibration   | Random, 2 g, 5 to 500 Hz   |
| Safety  | EN 61010-1:1993, ANSI/ISA S82.01-1994; CAN/CSA C22.2 No 1010.1:1992  |
| Power requirements                                      | 4 AA alkaline batteries  |
| Size  | 96 x 200 x 47 mm. (3.75 x 7.9 x 1.86 in)   |
| Weight  | 650 gm (1 lb, 7 oz)  |