



INSTRUMENTS

SC-04

Operator's Manual

Part Number: 71-0548

Revision: 0

Released: 1/5/23

WARNING

Read and understand this instruction manual before operating instrument. Improper use of the gas monitor could result in bodily harm or death.

Maintenance of the gas monitor is essential for proper operation and correct readings.

Bump test the instrument before each day's use with a known concentration of the target gas. A bump test can be done in User Mode's BUMP item or by applying gas in Measuring Mode. The instrument does not need to be calibrated unless it does not pass the User Mode bump test or does not respond appropriately, as defined by the user, in Measuring Mode. For more information about bump test and calibration requirements, see IEC 60079-29-2.

Table of Contents

Chapter 1: Introduction	7
Overview	7
About the SC-04	7
Specifications	8
About this Manual	10
Chapter 2: Description	11
Overview	11
Instrument Description	11
<i>Case</i>	<i>11</i>
<i>LCD</i>	<i>11</i>
<i>Control Buttons</i>	<i>12</i>
<i>Alarm LED</i>	<i>12</i>
<i>Buzzer</i>	<i>12</i>
<i>Vibrator</i>	<i>12</i>
<i>Sensor</i>	<i>13</i>
<i>Filters</i>	<i>13</i>
<i>Infrared Communications Port</i>	<i>13</i>
<i>Batteries</i>	<i>13</i>
Standard Accessories	14
<i>Alligator Clip</i>	<i>14</i>
Optional Accessories	15
<i>Belt Clip</i>	<i>15</i>
<i>Calibration Cup</i>	<i>16</i>
<i>IrDA/USB Cable</i>	<i>16</i>
Chapter 3: Measuring Mode	17
Overview	17
Start Up	17
<i>Turning On the SC-04</i>	<i>17</i>
<i>Performing a Demand Zero</i>	<i>22</i>
<i>Turning Off the SC-04</i>	<i>22</i>

Measuring Mode Operation	23
<i>Monitoring an Area</i>	23
Alarms	24
<i>Alarm Indications</i>	24
<i>Responding to Alarms</i>	26
Data Logging	29
Chapter 4: Display Mode	30
Tips for Using Display Mode	30
Peak Screen (PEAK).....	31
STEL Screen (STEL)	32
TWA Screen (TWA)	32
User ID Screen (USER ID).....	32
Station ID Screen (STN ID)	33
Last Successful Calibration Date (CAL.DATA).....	34
Last Successful Bump Test Screen (BP.DATA)	34
Date/Time Screen (DATE)	35
Temperature Screen (TEMP)	35
Alarm Points Screen (ALARM--P)	35
Adjusting the Buzzer Volume (BUZZ.VOL)	36
Chapter 5: User Mode and Calibration	37
Overview.....	37
Entering User Mode	41
Tips for Using User Mode	42
Performing a Bump Test (BUMP)	42
Performing a Calibration (GAS CAL)	46
Setting Calibration Parameters (CAL SET)	57
Setting Bump Test Parameters (BUMP.SET)	59
Alarm Settings (ALARM--P)	63
Updating the Lunch Break Setting (LUNCH)	65
Setting the Confirmation Beep and Non-Compliance Indicator (BEEP).....	66
Updating the Backlight Time (BL TIME).....	67
Turning the Key Tone On/Off (KEY.TONE)	68

Display Mode Items (DISP.SET)	68
Zero Suppression (ZERO.SUP)	69
Zero Follower (ZERO.FLW)	69
Turning Easy Calibration On/Off (E-CAL)	69
Setting the Date/Time (DATE)	70
Turning the Password On/Off (PASS-W)	70
Viewing the ROM/SUM (ROM/SUM)	71
Entering Measuring Mode (START)	71
Chapter 6: Maintenance	72
Overview	72
Troubleshooting	72
Replacing the Batteries	74
Replacing the Sensor Filter	76
Replacing the Hydrophobic Filter	79
Replacing the Sensor	81
Chapter 7: General Parts List	83
Appendix A: Maintenance Mode	86
Overview	86
Entering Maintenance Mode	88
Tips for Using Maintenance Mode	89
Performing a Calibration (GAS CAL)	89
Performing a Gas Test (GAS.TEST)	89
Sensor/Battery Replacement Date (SEN.DATE)	91
Performing a Bump Test (BUMP)	91
Setting Alarms to Latching or Self-Resetting (LATCH)	92
Turning the Demand Zero Function On/Off (D.ZERO)	92
Turning the Auto Zero Function On/Off (A.ZERO)	93
Turning the ID Display Function On/Off (ID DISP)	93
Turning the Zero Suppression On/Off (ZERO.SUP)	94
Turning the Zero Follower On/Off (ZERO.FLW)	94
User Mode Zero Suppression (ZSUP.DSP)	94
User Mode Zero Follower (ZFLW.DSP)	94

Cylinder Setting (CYL.DISP).....	95
Setting the Date/Time (DATE).....	95
Turning the Password On/Off (PASS-W).....	95
Viewing the ROM/SUM (ROM/SUM).....	96
Performing a Default (M.DEF).....	97
Entering Measuring Mode (START).....	97
Appendix B: Gas Select Mode.....	98
Overview.....	98
Entering Gas Select Mode.....	98
Tips for Using Gas Select Mode.....	99
Saving the Alarm Points (SAVE-AP).....	99
Turning the Calibration Max Span On/Off (MAX.SPAN).....	100
Stealth and Vibrator Settings (STEALTH).....	101
Exiting Gas Select Mode (START).....	101
Appendix C: Interference Information.....	102
ESR-A13D-HCN, HCN Detection.....	102
ESR-A13D-NO2, NO ₂ Detection.....	103
ESR-A13D-PH3, PH ₃ Detection.....	105
ESR-A13D-SO2, SO ₂ Detection.....	107
ESR-B134-NH3, NH ₃ Detection.....	109
ESR-B136-CL2, Cl ₂ Detection.....	110
Warranty.....	111

WARNING: *Understand manual before operating. This is an intrinsically safe product. Substitution of components may impair intrinsic safety. To prevent ignition of a hazardous atmosphere, batteries must only be changed or charged in an area known to be nonhazardous. Not tested in oxygen enriched atmospheres (above 21%).*

AVERTISSEMENT: *Comprendre le manuel avant de l'utiliser. Ceci est un produit intrinsèquement sûr. La substitution de composants peut nuire à la sécurité intrinsèque. Pour éviter l'inflammation d'une atmosphère dangereuse, les batteries ne doivent être remplacées ou chargées que dans une zone non dangereuse. Non testé dans des atmosphères enrichies en oxygène (plus de 21%).*

Chapter 1: Introduction

Overview

This chapter briefly describes the SC-04 gas monitor. This chapter also describes the SC-04 Operator's Manual (this document). Table 2 at the end of this chapter lists the specifications for the SC-04.

About the SC-04

Using an advanced detection system, the SC-04 personal gas monitor detects the presence of super toxic gases like HCN, PH₃, and SO₂. The SC-04's compact size and easy-to-use design make it ideally suited for a wide range of applications, including sewage treatment plants, utility manholes, tunnels, hazardous waste sites, power stations, petrochemical refineries, mines, paper mills, drilling rigs, and fire fighting stations. The SC-04 offers a full range of features, including:

- Liquid crystal display (LCD) for complete and understandable information at a glance
- Ultrabright alarm LED
- Distinctive audible/vibrating alarms for dangerous gas conditions and audible alarms for unit malfunction
- Microprocessor control for reliability, ease of use, and advanced capabilities
- Data logging functions
- Alarm trend data
- STEL, TWA, and over range alarms
- Peak reading
- Built-in time function
- Lunch break feature
- QPS "C/US" classification for Class I, Division I, Groups A, B, C, and D hazardous atmospheres

WARNING: The SC-04 detects elevated levels of super toxic gases which can be dangerous or life threatening. When using the SC-04, you must follow the instructions and warnings in this manual to assure proper and safe operation of the unit and to minimize the risk of personal injury. Be sure to maintain and periodically calibrate the SC-04 as described in this manual.

AVERTISSEMENT: *Le SC-04 détecte les niveaux élevés de gaz super toxiques qui peuvent être dangereux ou mettre la vie en danger. Lorsque vous utilisez le SC-04, vous devez suivre les instructions et les avertissements de ce manuel pour assurer un fonctionnement correct et en toute sécurité de l'appareil et pour réduire les risques de blessures. Assurez-vous de maintenir et d'étalonner périodiquement le SC-04 comme décrit dans ce manuel.*

Specifications

Table 1: Standard Sensor Specifications/Alarm Points

	Ammonia (NH ₃)	Chlorine (Cl ₂)	Hydrogen Cyanide (HCN)	Nitrogen Dioxide (NO ₂)	Phosphine (PH ₃)	Sulfur Dioxide (SO ₂)
Detection Range	0 - 400.0 ppm	0 - 20.00 ppm	0 - 30.0 ppm	0 - 20.00 ppm	0 - 20.00 ppm	0 - 100.00 ppm
Lowest Detectable Limit (LDL)	4.0 ppm	0.10 ppm	1.0 ppm	0.30 ppm	0.02 ppm	0.20 ppm
Reading Increment	0.5 ppm	0.05 ppm	0.1 ppm	0.05 ppm	0.01 ppm	0.05 ppm
Warning Setpoint	25 ppm	1.00 ppm	5.0 ppm	2.00 ppm	0.30 ppm	2.00 ppm
Alarm Setpoint	35 ppm	2.00 ppm	10.0 ppm	4.00 ppm	0.60 ppm	5.00 ppm
Alarm H Setpoint	300 ppm	10.00 ppm	30.0 ppm	20.00 ppm	0.60 ppm	100.00 ppm
STEL Setpoint	35 ppm	1 ppm	10.0 ppm	1.00 ppm	1.00 ppm	5.00 ppm
TWA Setpoint	25 ppm	0.5 ppm	4.7 ppm	0.50 ppm	0.30 ppm	2.00 ppm

Table 2: SC-04 Specifications

Sampling Method	Diffusion
Response Time	T90 Within 10 Seconds
Display	Graphics LCD Display
Operating Temperature & Humidity	Continuous environment: -20°C to 50°C/10 to 90% RH Temporary environment (up to 15 minutes): -40°C to 60°C/0 to 95% RH

Indication Accuracy	± 10% of reading or ± 5% of full scale (whichever is greater)
Safety/Regulatory	<ul style="list-style-type: none"> • ATEX: Certificate Number DEKRA 19ATEX0097 II 1G Ex ia IIC T4 Ga (with alkaline batteries) II 1G Ex ia IIC T3, Ga (with Ni-MH batteries) • IECEx: Certificate Number IECEx DEK 19.0059 Ex ia IIC T4 Ga (with alkaline batteries) Ex ia IIC T3 Ga (with Ni-MH batteries) • QPS classified, “C/US”, as Intrinsically Safe. Exia. Class I, Groups A, B, C, & D.
Instrument Power Information	<ul style="list-style-type: none"> • Operating Voltage: 3.0V • Operating Current: 1.0 mA • Operating Power: 3.0 mW
Power Supply	2 AAA alkaline batteries; 1.5V, 1.175 AH (Duracell MN2400 or PC2400) <u>OR</u> 2 AAA Ni-MH batteries; 1.2V, 800 mAH (Panasonic Eneloop BK-4MCC)
Continuous Operating Hours @ 25 °C	Alkaline Batteries: 3,000 hours in Measuring Mode (Non Alarm Operation, Fully Charged) Ni-MH Batteries: 2,000 hours in Measuring Mode (Non Alarm Operation, Fully Charged)
Case	High-impact Plastic, RF Shielded, Dust and Weather Proof (IP67)
Standard Accessories	<ul style="list-style-type: none"> • Alligator clip • Rubber boot
Optional Accessories	<ul style="list-style-type: none"> • Belt clip • Calibration cup • Datalogging and Setup Programs (Windows[®] 7, 8, 10, and 11), available at www.rkiinstruments.com/04series • IrDA/USB Cable for connecting to a computer when using the Datalogging and Setup Programs (not needed if computer has an infrared port)
Dimensions and Weight	Approximately 67(H) x 54(W) x 24(D) mm (2.6”H x 2.1”W x 0.9”D) Approximately 93 g (3.3 oz.)

About this Manual

The *SC-04 Operator's Manual* uses the following conventions for notes, cautions, and warnings.

NOTE: Describes additional or critical information.

CAUTION: *Describes potential damage to equipment.*

WARNING: *Describes potential danger that can result in injury or death.*

Chapter 2: Description

Overview

This chapter describes the SC-04 instrument and its accessories.

Instrument Description

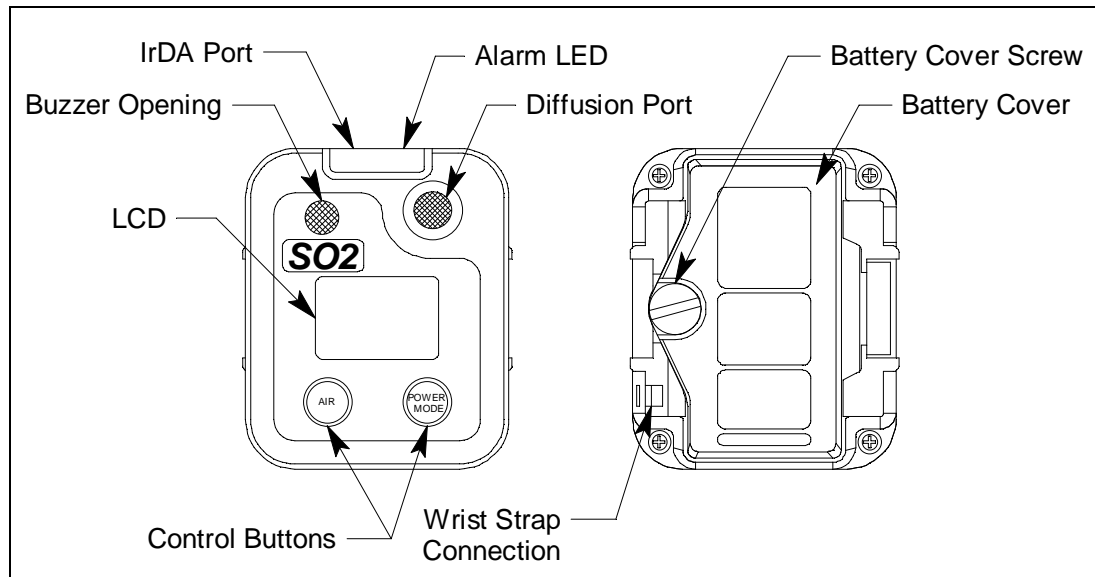

Figure 1: Component Location

Case

The SC-04's sturdy, high-impact plastic case is radio frequency (RF) resistant and is suitable for use in many environmental conditions, indoors and out. The case is dust proof and water resistant. A clear plastic window is located on the front of the case for viewing the LCD. The sensor retainer is located on the right side of the case and allows access to the filters and sensor. A feature in the lower left corner of the rear case is used to install the optional wrist strap.

LCD

A digital LCD (liquid crystal display) is visible through a clear plastic window in the top case. The LCD shows the gas reading. The LCD also shows information for each of the SC-04's operating modes.

Control Buttons

Two control buttons, AIR and POWER MODE, are located below the LCD.

Table 3: SC-04 Control Button Functions

Button	Function(s)
AIR	<ul style="list-style-type: none">• turns on LCD backlight• resets alarm condition if LATCH is set to ON in Maintenance Mode• enters User Mode, Maintenance Mode, and Gas Select Mode when used with POWER MODE• activates the demand zero function (adjusts the SC-04's fresh air reading)• changes the value of a parameter available for adjustment• scrolls through parameter options
POWER MODE	<ul style="list-style-type: none">• turns the SC-04 on and off• turns on LCD backlight• enters and scrolls through Display Mode• enters instructions into the SC-04's microprocessor• resets alarm condition if LATCH is set to ON in Maintenance Mode• enters User Mode, Maintenance Mode, and Gas Select Mode when used with AIR

Alarm LED

The alarm LED above the sensor and buzzer openings alerts you to gas, low battery, and failure alarms.

Buzzer

One solid-state electronic buzzer is located inside the case. Sound exits the case through a hole in the upper left corner of the front case. The buzzer sounds for gas alarms, malfunctions, and low battery voltage. It also provides feedback for button presses and while in Display, User, Maintenance, or Gas Select Mode.

Vibrator

A vibrating motor inside the SC-04 case vibrates for gas alarms and unit malfunctions.

NOTE: If **STEALTH** is set to **ON**, the vibrator only functions when **VIB** in the **STEALTH** Gas Select Mode item is set to **ON** (see page 101).

Sensor

The sensor is an electrochemical cell that consists of two precious metal electrodes in a dilute acid electrolyte. A gas permeable membrane covers the sensor face and allows gas to diffuse into the electrolyte. The gas reacts in the sensor and produces a current proportional to the concentration of the target gas. The SC-04's circuitry amplifies the current, converts the current to a gas concentration, and displays the concentration on the LCD.

Each target gas has its own sensor.

Filters

NO₂ and SO₂ Sensors' H₂S Removal Filter Disk (Tan)

An H₂S removal filter disk is placed into a recess in the sensor gasket over the NO₂ or SO₂ sensor. The filter disk prolongs the life of the sensors by preventing H₂S in the ambient air from reaching the sensor. The filter should be replaced every 6 months.

HCN Sensor H₂S Removal Filter Disk (Dark Gray)

An H₂S removal filter disk is placed into a recess in the sensor gasket over the HCN sensor. The filter disk prolongs the life of the sensors by preventing H₂S in the ambient air from reaching the sensor. The filter should be replaced every 6 months.

PH₃ Sensor Humidity Filter (White)

A white humidity filter is placed into a recess in the sensor gasket over the PH₃ sensor. The filter absorbs humidity in the sampling environment to prevent unstable readings around 0 ppm. The filter should be replaced every 6 months.

NH₃ Sensor's Humidity Filter (White)

A white humidity filter is placed into a recess in the filter gasket over the NH₃ sensor. The filter absorbs humidity in the sampling environment to prevent unstable readings around 0 ppm. The filter should be replaced every 6 months.

Hydrophobic Filter

The white, circular hydrophobic filter fits into a recessed area in the front case and is held in place by the sensor gasket. It prevents water and particulates from entering the instrument.

Infrared Communications Port

An infrared (IR) communications port is located at the top of the instrument, near the LED. Logged data transmits through the port in standard IrDA protocol. A computer's infrared port or an IrDA/USB cable connected to a USB port can be used to download data to the 04 Series Datalogging Program. See the 04 Series Datalogging Program operator's manual for data logging and downloading instructions.

Batteries

2 AAA batteries (alkaline or Ni-MH) power the SC-04. At 25°C alkaline batteries will last at least 3,000 hours (125 days) and Ni-MH batteries will last at least 2,000 hours (83 days). The battery icon in the upper right of the LCD shows remaining battery life.

A low battery warning activates when the SC-04 detects a low battery voltage. The SC-04 sounds a dead battery alarm when battery voltage is too low for Measuring Mode.

WARNING: Use only Duracell MN2400 or PC2400 or Eneloop BK-4MCC batteries to maintain the QPS classification of the SC-04. Use of other batteries will void the QPS classification and may void the warranty. Do not mix old/new or different types of batteries.

AVERTISSEMENT: Utiliser uniquement des piles Duracell MN 2400 ou PC 2400 ou Eneloop BK-4MCC de maintenir la classification QPS de la SC-04. L'utilisation d'autres piles annule la classification QPS et peut annuler la garantie. Ne mélangez pas les anciennes/nouvelles ou différents types de piles.

WARNING: To prevent ignition of a hazardous atmosphere, the batteries must only be changed in an area known to be nonhazardous.

AVERTISSEMENT: Pour éviter l'inflammation d'une atmosphère dangereuse, la batterie ne doit être remplacée que dans une zone non dangereuse.

Standard Accessories

Alligator Clip

An alligator clip installs to 2 spring bars on the rear case. Use the alligator clip to attach the SC-04 to clothing or a belt. Teeth in the alligator clip's jaws prevent slipping. The alligator clip can be rotated to change the instrument's orientation.

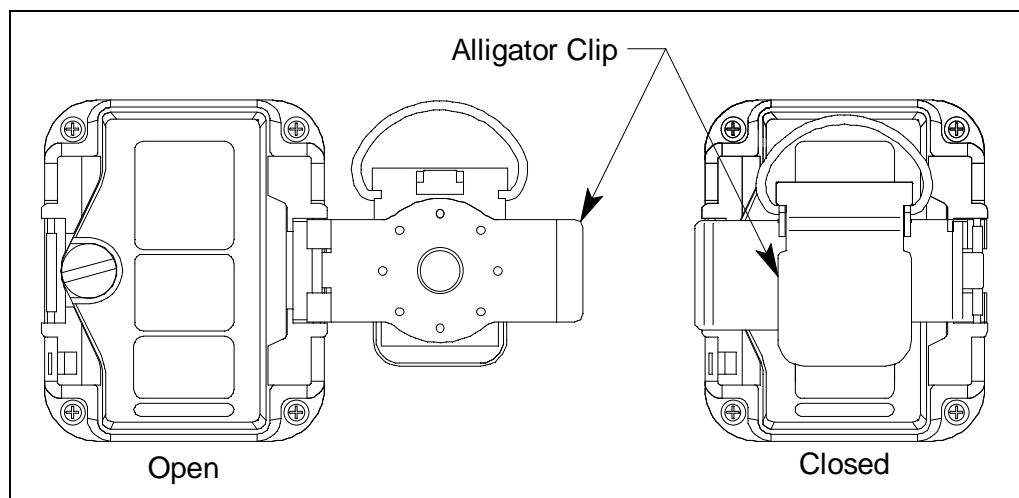

Figure 2: Alligator Clip

Protective Rubber Boot

A protective rubber boot is installed over the SC-04.

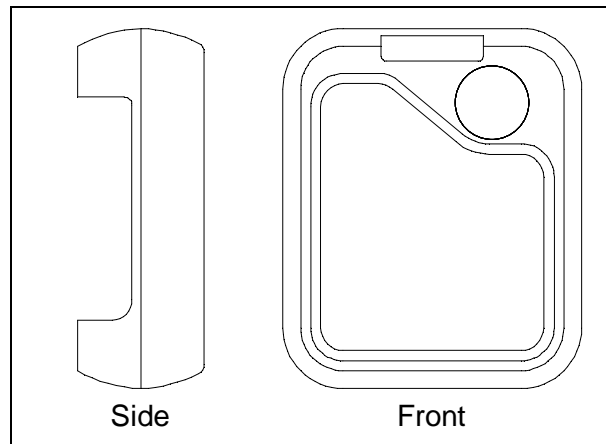

Figure 3: Rubber Boot

Optional Accessories

Belt Clip

The belt clip installs to 2 spring bars on the rear case and is used to easily clip the SC-04 onto a belt.

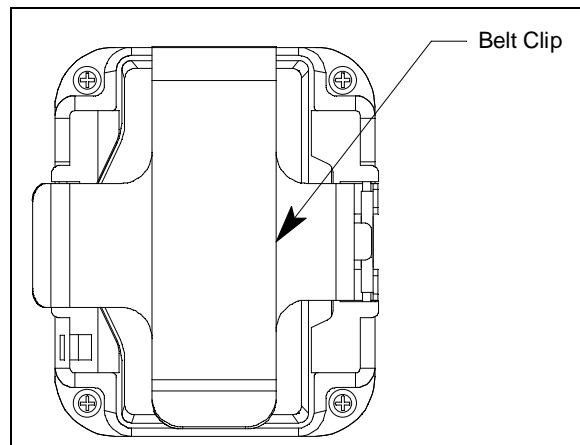

Figure 4: Belt Clip

Wrist Strap

The wrist strap connects to a feature on the back case.

Calibration Cup

The calibration cup installs over the sensor. You must use the calibration cup when performing a bump test, calibration, or gas test.

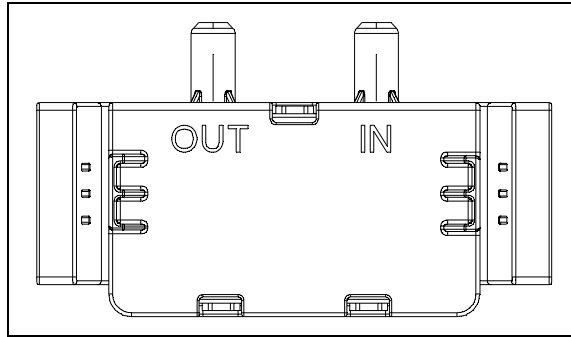

Figure 5: Calibration Cup

IrDA/USB Cable

Unless your computer has a built-in IrDA port, a IrDA/USB cable is needed to establish communication between the SC-04 and the Datalogging Program or the Setup Program.

Chapter 3: Measuring Mode

Overview

This chapter explains how to use the SC-04 to perform confined space entry monitoring or general area monitoring in Measuring Mode.

Start Up

This section explains how to start up the SC-04, get it ready for operation, and turn it off.



Turning On the SC-04

To illustrate certain functions, the following description of the SC-04 start up sequence assumes that the following items in User Mode are turned on: **LUNCH**, **CAL.RMDR**, and **BP.RMDR** in User Mode, and **ID DISP** and **A.ZERO** in Maintenance Mode. If any of these items are turned off, then the corresponding screens do not appear.

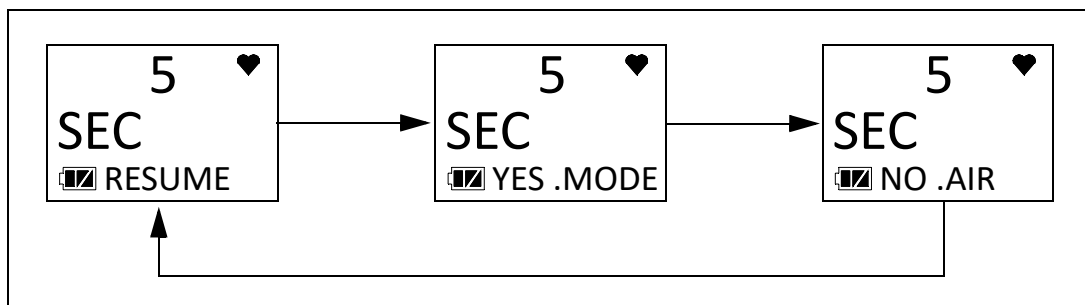
1. Press and briefly hold down POWER MODE. Release the button when you hear a beep.
2. If **LUNCH** is set to **ON** (factory setting if **OFF**, see page 65), the Lunch Break Screen appears. The unit counts down from 5 seconds.

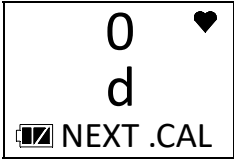

- a. Continue Accumulating: To continue accumulating peak and time-weighted average (TWA) readings from the last time the SC-04 was used, press and release POWER MODE or allow the countdown to reach 0. The short-term exposure limit (STEL) reading is reset each time the SC-04 is turned on.
 - b. Reset Accumulation: To reset the accumulation of peak and time-weighted average (TWA) readings, press and release AIR before the countdown reaches 0.
3. If **CAL.RMDR** is set to **ON** (factory setting) and a calibration is due, the screen that appears next depends on how **CAL.EXPD** is set in User Mode (see page 58). The three possible screens are described below. If a calibration is not due, the instrument displays the number of days left until a calibration is due.

	CAL.EXPD set to CONFIRM (factory setting)	CAL.EXPD set to CANT.USE	CAL.EXPD set to NONE
LCD			
Sound	Buzzer sounds double pulsing tone	Buzzer sounds double pulsing tone	None
Action	<ul style="list-style-type: none"> • <u>Option A, Perform calibration</u>: Press and release POWER MODE to enter User Mode and perform a calibration. The instrument takes you straight to the calibration start screen in User Mode's GAS CAL\A-CAL(E-CAL) item (if Password Protection is set to On using the 04 Series Setup Program, you must enter a password first). See page 46 for calibration instructions. If the calibration is successful, the screen above will not appear again until the unit is due for calibration. If the calibration is not successful, the screen above will again appear in the startup sequence. • <u>Option B, Bypass message</u>: To continue without performing a calibration, press and release AIR. 	<p>The SC-04 cannot be used until a successful calibration is performed. Press and release POWER MODE to enter User Mode and perform a calibration. The instrument takes you straight to the calibration start screen in User Mode's GAS CAL/A-CAL (E-CAL) item (if Password Protection is set to On using the 04 Series Setup Program, you must enter a password first). If you don't press POWER MODE, the instrument automatically goes to the calibration start screen after 6 seconds (if Password Protection is set to On using the 04 Series Setup Program, you must enter a password first). See page 46 for calibration instructions.</p> <p>If the calibration is successful, the screen above will not appear again until the unit is due for calibration. If the calibration is not successful, the screen above will again appear in the startup sequence.</p>	<ul style="list-style-type: none"> • <u>Option A, Perform calibration</u>: If you want to enter User Mode and perform a calibration, press and release POWER MODE. The instrument takes you straight to the calibration start screen in User Mode's GAS CAL/A-CAL (E-CAL) item (if Password Protection is set to On using the 04 Series Setup Program, you must enter a password first). • <u>Option B, Bypass message</u>: To continue without performing a calibration, wait a few seconds for the instrument to continue with its startup sequence.

4. If **BP.RMDR** is set to **ON** (factory setting is **OFF**) and a bump test is due, the screen that appears next depends on how **BP.EXPD** is set in User Mode (see page 62). The three possible screens are described below. If a bump test is not due, the instrument displays the number of days left until a bump test is due.

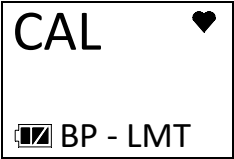
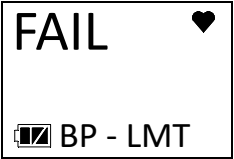
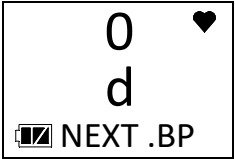
	BP.EXPD set to CONFIRM (factory setting)	BP.EXPD set to CANT.USE	BP.EXPD set to NONE
LCD			
Sound	Buzzer sounds double pulsing tone	Buzzer sounds double pulsing tone	None
Action	<ul style="list-style-type: none"> • <u>Option A, Perform bump test:</u> Press and release POWER MODE to enter User Mode and perform a bump test. The instrument takes you straight to the bump test start screen in User Mode's BUMP item (if Password Protection is set to On using the 04 Series Setup Program, you must enter a password first). See page 42 for bump test instructions. If the bump test is successful, the screen above will not appear again until the unit is due for bump testing. If the bump test is not successful, the screen above will again appear in the startup sequence. • <u>Option B, Bypass message:</u> To continue without performing a bump test, press and release AIR. 	<p>The SC-04 cannot be used until a successful bump test is performed. Press and release POWER MODE to enter User Mode and perform a bump test. The instrument takes you straight to the bump test start screen in User Mode's BUMP item (if Password Protection is set to On using the 04 Series Setup Program, you must enter a password first). If you don't press POWER MODE, the instrument automatically goes to the bump test start screen after 6 seconds (if Password Protection is set to On using the 04 Series Setup Program, you must enter a password first). See page 42 for bump test instructions.</p> <p>If the bump test is successful, the screen above will not appear again until the unit is due for bump testing. If the bump test is not successful, the screen above will again appear in the startup sequence.</p>	<ul style="list-style-type: none"> • <u>Option A, Perform bump test:</u> If you want to enter User Mode and perform a bump test, press and release POWER MODE. The instrument takes you straight to the bump test start screen in User Mode's BUMP item (if Password Protection is set to On using the 04 Series Setup Program, you must enter a password first). • <u>Option B, Bypass message:</u> To continue without performing a bump test, wait a few seconds for the instrument to continue with its startup sequence.

5. The Date/Time Screen appears for a few seconds.

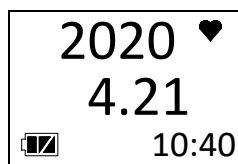

- The Battery Voltage Screen appears for a few seconds. An “AL-L” at the bottom of the screen indicates that the alarms are set to latching. An “AL-A” at the bottom of the screen indicates that the alarms are set to auto reset. See page 92 for a description of how to change this parameter.

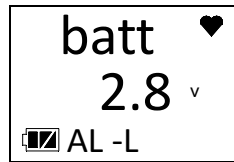

- The following screens display for 1 second each: Gas Name, Full Scale, Warning Setpoint, Alarm Setpoint, Alarm H Setpoint, STEL Setpoint, and TWA Setpoint.

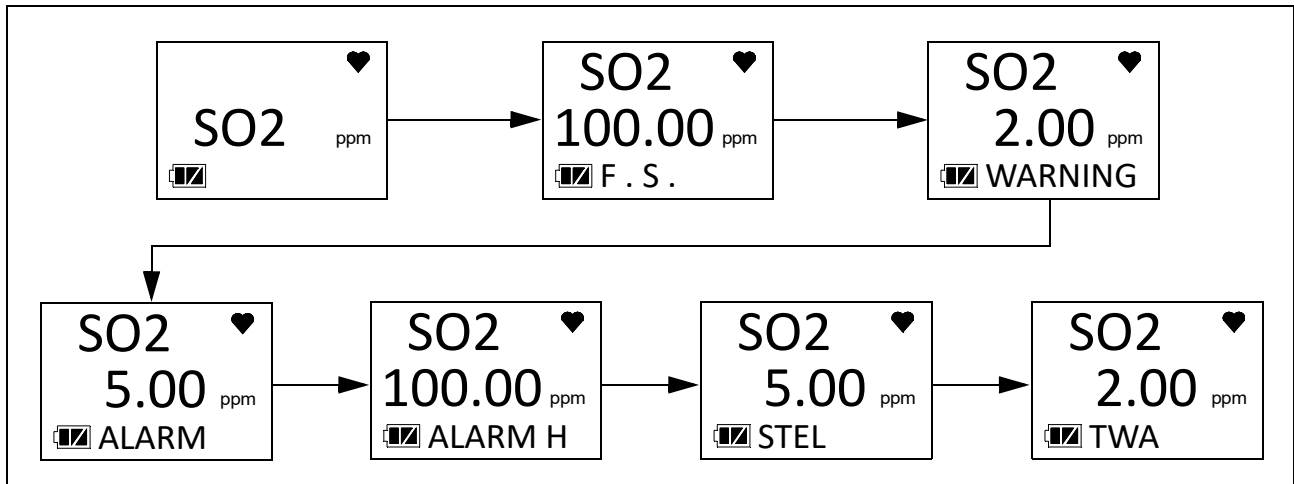

- If **ID DISP** is set to **ON** (factory setting is **OFF**, see page 93), the User ID Screen appears for a few seconds, followed by the Station ID Screen.

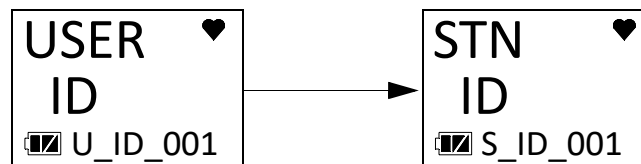

- If the SC-04 experiences a sensor failure during start up, a screen indicating that the sensor failed appears and the buzzer sounds a double pulsing tone once per second.

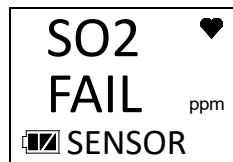

You cannot acknowledge the failure and continue to Measuring Mode. Replace the failed sensor as soon as possible.

10. If **A.ZERO** is set to **ON** (factory setting is **OFF**, see page 93), the instrument prompts you to do an auto zero. An auto zero operation sets the reading to 0 ppm.

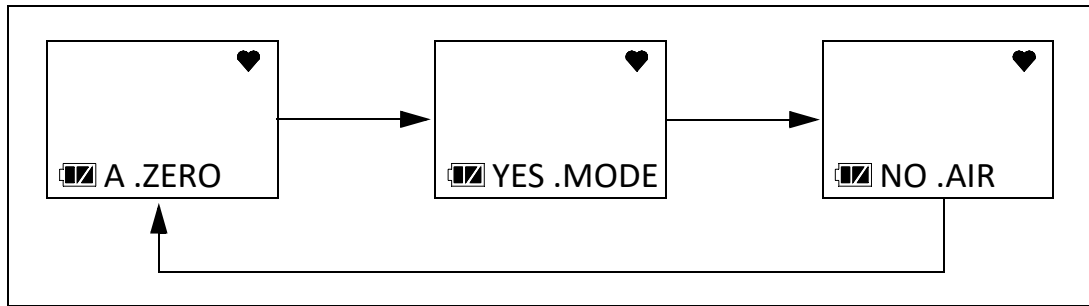

WARNING: *Make sure that the instrument is in a known fresh air environment (an environment free of combustible or toxic gases and of normal oxygen content, 20.9%) before performing an auto zero operation. If you perform an auto zero operation in an area with gases present, the adjustment will not be accurate.*

You must press and release the POWER MODE button to perform an auto zero function. If you do not press any key, after 15 seconds, the instrument enters Measuring Mode without performing an auto zero.

If **Password Protection** is turned **On** (factory setting is **Off**) using the 04 Series Setup Program, a user-set password is required to perform an auto zero. When the password screen appears, adjust each digit with the AIR button and press and release the POWER MODE button to move on to the next digit. Once the password is entered, the instrument performs the auto zero.

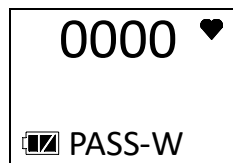

11. The SC-04 is now monitoring for gas in Measuring Mode. The Measuring Mode Screen displays the current gas reading.



Performing a Demand Zero

Perform a demand zero before using the SC-04. This sets the reading to 0 ppm.

1. Find a fresh-air environment. This is an environment free of toxic or combustible gases and of normal oxygen content (20.9%).
2. Turn on the unit as described above in Turning On the SC-04.
3. Press and hold AIR. The buzzer pulses and the LCD prompts you to continue holding AIR (if **KEY.TONE** is set to **ON** in User Mode).
4. Continue to hold AIR until the LCD prompts you to release it. The SC-04 sets the fresh air reading. Start up is complete and the unit is now ready for monitoring.
5. If **Password Protection** is turned **On** (factory setting is **Off**) using the 04 Series Setup Program, a user-set password is required to perform a demand zero. When the password screen appears, adjust each digit with the AIR button and press and release the POWER MODE button to move on to the next digit. Once the password is entered, the instrument sets the fresh air reading.

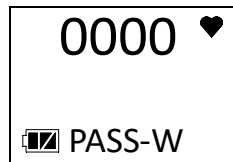

Turning Off the SC-04

1. Press and hold POWER MODE.
2. OFF appears on the display and the buzzer pulses for about five seconds (if **KEY.TONE** is set to **ON** in User Mode).
3. Release the button when OFF disappears from the display.
4. If **Password Protection** is turned **On** (factory setting is **Off**) using the 04 Series Setup Program, a user-set password is required to turn off the SC-04. When the password screen appears, adjust each digit with the AIR button and press and release the POWER MODE button to move on to the next digit. Once the password is entered, the instrument shuts off.

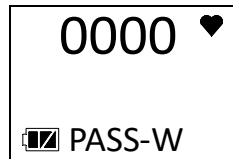

Measuring Mode Operation

When the SC-04 completes its startup sequence, it is in Measuring Mode. In Measuring Mode the SC-04 continuously monitors the sampled atmosphere and displays the gas concentration. The SC-04 is in Normal Operation if there are no alarm indications.



Heart Symbol: The heart symbol in the top right corner of the LCD indicates the operation status and flashes when normal. A microprocessor error causes the heart symbol to stop flashing or to disappear.

Check Mark: If **BP.RMDR** is set to **ON** and if a bump test is not due, a check mark appears in the lower left corner of the LCD.

“S”: If the instrument is operating in Stealth Mode, an “S.” appears at the bottom of the LCD.

Backlight: In a low-light environment, press and release either button to turn on the display backlight. See page 67 to program backlight duration.

Confirmation/Non-Compliance Indicator: If the **BEEP** item in User Mode is set to anything other than **OFF**, the SC-04 gives periodic indications to confirm that it’s operating or to indicate a non-compliance (see page 66).

Monitoring an Area

1. Start up the SC-04 as described above in “Start Up” on page 17. It is now in Measuring Mode.

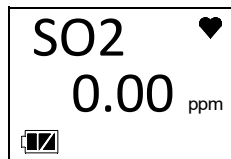

2. The instrument displays the gas reading.
3. Take the SC-04 to the monitoring area.
4. Wait at least 15 seconds.
5. If a reading is observed, allow the reading to stabilize to determine the gas concentration present.
6. If a gas alarm occurs, take appropriate action. See page 26.

Interference Information

Some gases interfere with the super toxic sensors. For a complete list of these gases, see page 102.

Alarms

This section covers alarm indications in Measuring Mode. It also describes how to reset the SC-04 after an alarm occurs and how to respond to an alarm condition.

NOTE: False alarms may be caused by radio frequency (RF) or electromagnetic (EMI) interference. Keep the SC-04 away from RF and EMI sources such as radio transmitters or large motors.

Alarm Indications

The SC-04 buzzer sounds an alarm, the LED flashes, and the vibrator pulses when any sort of alarm condition or failure occurs. If the SC-04 is operating in Stealth Mode, the buzzer does not sound and the vibrator's operation depends on the **VIB** setting in Gas Select Mode's **STEALTH** item. See page 101 for more information.

NOTE: If an alarm condition occurs while you are in Display Mode, the SC-04 automatically returns to the Measuring Mode screen.

The table below summarizes the types of alarms produced by the SC-04 and their indications.

Table 4: Alarm Types and Indications

Alarm Type	Visual Indications	Other Indications
<u>Warning</u> Concentration of gas rises above the Warning setting.	<ul style="list-style-type: none">• Gas reading flashes• WARNING appears at the bottom of the LCD• Alarm LED flashes once per second• Backlight turns on	<ul style="list-style-type: none">• High-low tone sounds once per second• Vibrator pulses once per second
<u>Alarm</u> Concentration of gas rises above the Alarm setting.	<ul style="list-style-type: none">• Gas reading flashes• ALARM appears at the bottom of the LCD• Alarm LED flashes twice per second• Backlight turns on	<ul style="list-style-type: none">• High-low tone sounds twice per second• Vibrator pulses twice per second
<u>Alarm H</u> Concentration of gas rises above the Alarm H setting.	<ul style="list-style-type: none">• Gas reading flashes• ALARM H appears at the bottom of the LCD• Alarm LED flashes twice per second• Backlight turns on	<ul style="list-style-type: none">• High-low tone sounds twice per second• Vibrator pulses twice per second

Table 4: Alarm Types and Indications

Alarm Type	Visual Indications	Other Indications
<u>TWA or STEL</u> Concentration rises above the TWA or STEL alarm setting.	<ul style="list-style-type: none"> • Gas reading flashes • TWA or STEL appears at the bottom of the LCD • Alarm LED flashes once per second • Backlight turns on 	<ul style="list-style-type: none"> • High-low tone sounds once per second • Vibrator pulses once per second
<u>Over Range</u>	<ul style="list-style-type: none"> • Gas reading is replaced with a flashing □□□ • Gas name and units flash • OVER appears at the bottom of the LCD • Alarm LED flashes twice per second • Backlight turns on 	<ul style="list-style-type: none"> • High-low tone sounds twice per second • Vibrator pulses twice per second
<u>Minus Over Range</u>	<ul style="list-style-type: none"> • Affected channel's gas reading is replaced with a flashing “- - - -” • Gas name and units flash • MOVER appears at the bottom of the LCD • Alarm LED flashes twice per second • Backlight turns on 	<ul style="list-style-type: none"> • High-low tone sounds twice per second • Vibrator pulses twice per second
<u>Low Battery Warning</u>	<ul style="list-style-type: none"> • The last bar in the battery icon starts flashing 	None
<u>Dead Battery Alarm</u>	<ul style="list-style-type: none"> • Gas reading disappears. FAIL BATTERY appears on the LCD. • Alarm LED flashes once per second 	Double pulsing tone sounds once per second
<u>Sensor Failure</u>	<ul style="list-style-type: none"> • FAIL SENSOR appears on the LCD. • Alarm LED flashes once per second 	Double pulsing tone sounds once per second
<u>Clock Failure</u>	<ul style="list-style-type: none"> • FAIL 050 CLOCK appears on the LCD • Alarm LED flashes once per second 	Double pulsing tone sounds once per second

Table 4: Alarm Types and Indications

Alarm Type	Visual Indications	Other Indications
<u>System Failure</u>	<ul style="list-style-type: none"> • FAIL SYSTEM and an error code appear on the LCD • Alarm LED flashes once per second 	Double pulsing tone sounds once per second

Responding to Alarms

This section describes response to gas, over range, battery, sensor failure, clock failure, and system failure alarms.

Responding to Gas Alarms

1. Follow your established procedure for an increasing gas condition.
2. Reset the alarm as necessary or allowed.
 - a. If **LATCH** is set to **ON** (factory setting) in Maintenance Mode, the gas reading must fall below an alarm setting before you can reset the alarm condition using **POWER MODE** or **AIR**.

If **Password Protection** is turned **On** (factory setting is **Off**) using the 04 Series Setup Program, you must press **POWER MODE** and **AIR** at the same time and then enter a user-set password to reset an alarm condition. When the password screen appears, adjust each digit with the **AIR** button and press and release the **POWER MODE** button to move on to the next digit. Once the password is entered, the alarm condition resets.

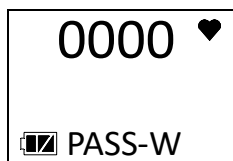

- b. If **LATCH** is set to **OFF** in Maintenance Mode, the alarm condition automatically resets when gas reading falls below an alarm setpoint.

Responding to Over Range Alarms

WARNING: *An over range condition may indicate an extreme carbon monoxide concentration or an explosive concentration. Confirm the gas concentration with a different SC-04 or with another gas detecting device.*

AVERTISSEMENT: *Un dépassement de la plage peut indiquer une concentration extrême en monoxyde de carbone ou une concentration en explosif. Confirmez la concentration de gaz avec un SC-04 différent ou avec un autre dispositif de détection de gaz.*

1. Follow your established procedure for an extreme gas condition.

2. Reset the alarm using POWER MODE or AIR once the alarm condition clears if **LATCH** is set to **ON** (factory setting) in Maintenance Mode.

If **Password Protection** is turned **On** (factory setting is **Off**) using the 04 Series Setup Program, you must press POWER MODE and AIR at the same time and then enter a user-set password to reset an alarm condition. When the password screen appears, adjust each digit with the AIR button and press and release the POWER MODE button to move on to the next digit. Once the password is entered, the alarm condition resets.

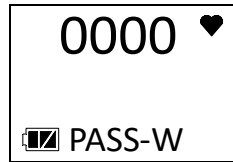

3. Calibrate the SC-04 as described on page 46.
4. If the over range condition continues or if you are not able to successfully calibrate the unit, you may need to replace the sensor.
5. If the over range condition continues after you replace the sensor, contact RKI Instruments, Inc. for further instructions.

Responding to Battery Alarms

WARNING: *The SC-04 is not operational as a gas monitoring device during a dead battery alarm. Take the SC-04 to a non-hazardous area and replace the batteries as described in “Replacing the Batteries (Alkaline or Ni-MH)” on page 74.*

The SC-04 is fully functional during a low battery warning. However, only a couple of days of operating time remain. The amount of time depends on LCD backlight use and alarm frequency. Replace the batteries as described on page 74 as soon as possible.

NOTE: Alarms and the LCD backlight consume battery power and reduce the amount of operating time remaining.

Responding to Sensor Failure Alarms

1. Calibrate the sensor as described on page 46.
2. If the sensor failure continues, replace the sensor as described on page 81.
3. If the sensor failure condition continues after replacing the sensor, contact RKI Instruments, Inc. for further instructions.

Responding to Clock Failure Alarms

A clock failure alarm occurs if the unit's internal clock malfunctions.



1. Press and release POWER MODE to continue into Measuring Mode.

CAUTION: *There is no datalogging function if you operate the instrument after a clock failure.*

2. Attempt to set the date using the **DATE** item in User Mode (see page 70).
3. If the date cannot be set correctly, contact RKI Instruments, Inc. as soon as possible.

Responding to System Failure Alarms

1. If a system failure occurs, the system failure screen displays an error code as shown below.



2. The error code meanings are shown in the table below:

Table 5: Error Code Explanation

Error Code	Explanation
000	ROM failure
010	RAM failure
020	FRAM failure
031	FLASH memory failure
082	Temperature sensor failure

3. If the error code is anything but 031, the instrument cannot be used. Contact RKI Instruments, Inc. as soon as possible.

If the error code is 031, press and release POWER MODE to continue into Measuring Mode if the instrument must be used temporarily.

CAUTION: *There is no datalogging function if you operate the instrument after a 031 system failure. Contact RKI Instruments, Inc. as soon as possible.*

Data Logging

The SC-04 logs Measuring Mode gas readings, alarm data, and calibration data to its internal memory. Logged data can be download it to a computer via the infrared communications port on the front of the unit.

The data logging capacity depends on how often the SC-04 stores data and how often the SC-04 is turned on and off. The table below illustrates how much data logging time is available for the various interval times. It assumes that the unit is only turned on once and there are no alarms. The data logging interval time must be set using the 04 Series Datalogging Program.

Table 6: Data Logging Capacity

Interval Time	Data Logging Capacity
10 seconds	10 hours
20 seconds	20 hours
30 seconds	30 hours
1 minute	60 hours
3 minutes	180 hours
5 minutes	300 hours
10 minutes	600 hours

To utilize the SC-04's downloading capability, you need:

- PC with Windows 7, Windows 8, Windows 10, or Windows 11
- IrDA port or IrDA/USB cable (cable available from RKI Instruments, Inc.)
- 04 Series Datalogging Program (available at www.rkiinstruments.com/04series).

For a complete description of the Datalogging Program and procedures for downloading data to a computer, see the 04 Series Datalogging Program Operator's Manual.

Chapter 4: Display Mode

This section describes Display Mode which is accessible from Measuring Mode. See Table 7 below for a list of Display Mode's menu items, a short description of each item, and the page number for further description.

Table 7: Display Mode Menu Items

Display Mode Menu Item	Description
PEAK (page 31)	Displays the Peak reading.
STEL (page 32)	Displays the STEL reading.
TWA (page 32)	Displays the TWA reading.
USER ID (page 32) ^A	View and/or change the User ID.
STN ID (page 33) ^A	View and/or change the Station ID.
CAL.DATA (page 34) ^B	Displays the last calibration date.
BP.DATA (page 34) ^C	Displays the last bump test date.
DATE (page 35)	Displays the current date and time.
TEMP (page 35)	Displays the current temperature.
ALARM--P (page 35)	View alarm points.
BUZZ.VOL (page 36) ^D	Set the buzzer volume to LO or HI (factory setting).
<p>^A Only appears if DISP.SET is set to ON in User Mode (factory setting) <u>and</u> if ID DISP is set to ON in Maintenance Mode (factory setting is OFF).</p> <p>^B Only appears if CAL.RMDR is set to ON in User Mode (factory setting).</p> <p>^C Only appears if BP.RMDR is set to ON in User Mode (factory setting is OFF).</p> <p>^D Only appears if DISP.SET is set to ON in User Mode (factory setting).</p>	

Tips for Using Display Mode

- To enter Display Mode and scroll from one item to the next or skip an item when a question is asked, press and release POWER MODE.
- To enter an item, press and release AIR.

- To change a flashing parameter, press and release AIR. To reverse the movement in a list (ie. from down to up or vice versa):
 - a. Press and hold AIR.
 - b. Immediately press POWER MODE and then release both buttons.
- To exit from an entered-information screen and go back to Measuring Mode, press and release POWER MODE until you get to the Measuring Mode screen.

NOTE: Each screen displays for 20 seconds. If you do not press a button within 20 seconds, the SC-04 automatically returns to Measuring Mode.

Peak Screen (PEAK)

The peak screen displays the highest concentration detected since the SC-04 was turned on. The peak reading is stored until a higher level is detected, the peak reading is cleared, or the SC-04 is turned off.

The lunch break feature enables the SC-04 to save the peak reading when it is turned off so it can continue with the same peak when it is turned on again (see page 17).



To clear the peak reading, do the following:

NOTE: If **Password Protection** is set to **On** using the 04 Series Setup Program, the peak reading cannot be cleared.

1. After entering Display Mode, press and release POWER MODE until **PEAK** appears.
2. Press and hold AIR until the screen prompts you to release it.

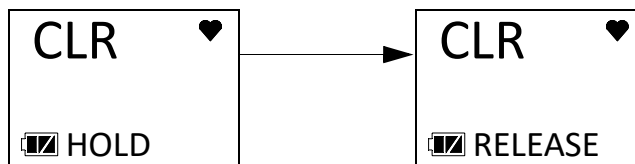

3. The peak reading is reset and the unit returns to the Peak Screen.

If you do not want to clear the peak reading, release AIR before the above screen sequence occurs. The unit returns to the Peak Screen.

STEL Screen (STEL)

The STEL Screen displays the short term exposure limit (STEL) reading. The STEL reading is the average reading *over the last 15 minutes*.



TWA Screen (TWA)

The TWA Screen displays the time weighted average (TWA) reading.

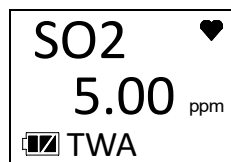

The TWA reading is the average reading *over the last 8 hours*. If 8 hours have not elapsed since the last time the TWA reading was cleared, the average is still calculated over 8 hours. The missing readings are assigned a value of 0. If **LUNCH** is set to **OFF** (factory setting), the TWA is cleared when the SC-04 is turned off.

If **LUNCH** is set to **ON**, the SC-04 remembers the TWA reading when it is turned off and can continue accumulation when it is turned on again (see page 17).

Changing the User ID (USER ID)

This screen only appears if **DISP.SET** in User Mode is set to **ON** (factory setting) and if **ID DISP** in Maintenance Mode is set to **ON** (factory setting is **OFF**).

Use this screen to select a user ID from the 128 user IDs that are stored in the SC-04's memory. Before a user ID is selected on a brand new instrument, the user ID is "-----". The factory-installed user IDs have a "U_ID_XXX" format.

The user ID provides a way to identify the SC-04 user during a data logging session.

User IDs can only be selected in this menu item. In order to edit the 128 user IDs, you must use the 04 Series Datalogging Program or 04 Series Setup Program.

1. After entering Display Mode, press and release POWER MODE until the **USER ID** screen sequence appears.

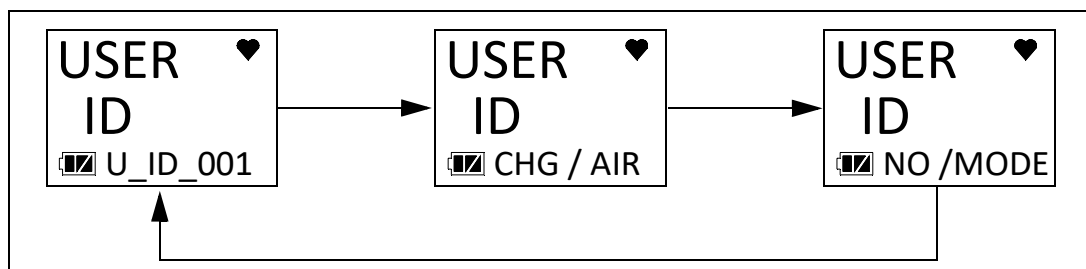

- To change the User ID, press and release AIR. The current User ID flashes.

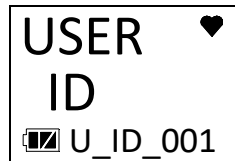

- Use AIR to scroll to the desired User ID.
- Press and release POWER MODE to save the User ID and return to the **USER ID** screen in Display Mode.

Changing the Station ID (STN ID)

This screen only appears if **DISP.SET** in User Mode is set to **ON** (factory setting) and if **ID DISP** in Maintenance Mode is set to **ON** (factory setting is **OFF**).

Use this screen to select a station ID from the 128 station IDs that are stored in the SC-04's memory. Before a station ID is selected on a brand new instrument, the station ID is "-----". The factory-installed station IDs have a "S_ID_XXX" format.

The station ID provides a way to identify the SC-04 location during a data logging session.

User IDs can only be selected in this menu item. In order to edit the 128 user IDs, you must use the 04 Series Datalogging Program or 04 Series Setup Program.

- After entering Display Mode, press and release POWER MODE until the **STN ID** screen sequence appears.

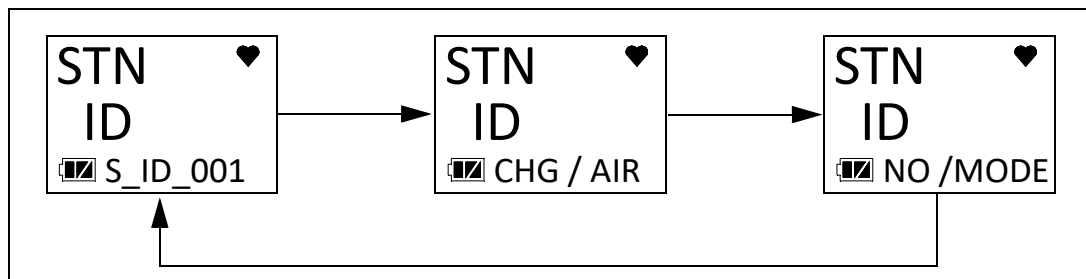

- To change the Station ID, press and release AIR. The current Station ID flashes.

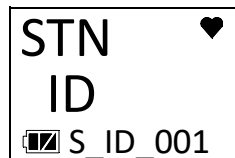

- Use AIR to scroll to the desired Station ID.
- Press and release POWER MODE to save the Station ID and return to the **STN ID** screen in Display Mode.

Last Successful Calibration Date (CAL.DATA)

The **CAL.DATA** screen shows the date of the last successful calibration. This screen only appears if **CAL.RMDR** is set to **ON** (factory setting).

1. After entering Display Mode, press and release **POWER MODE** until the **CAL.DATA** screen sequence appears.

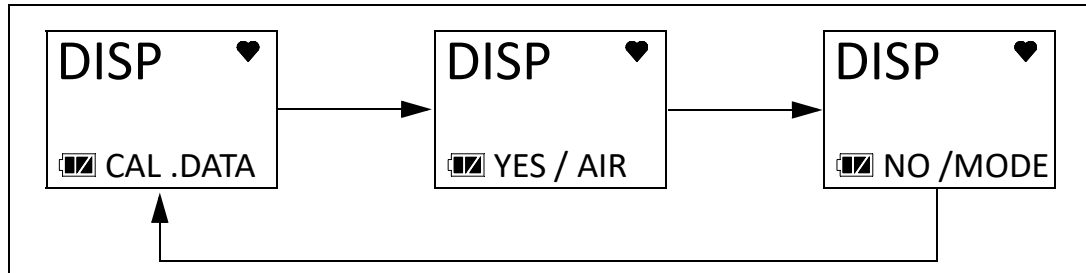

2. Press **AIR** to enter the **CAL.DATA** screen. The date of the last successful calibration displays.

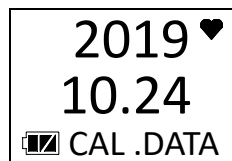

3. Press and release **POWER MODE** to return to the **CAL.DATA** screen in Display Mode.

Last Successful Bump Test Date (BP.DATA)

The **BP.DATA** screen shows the date of the last successful bump test. This screen only appears if **BP.RMDR** is set to **ON** (factory setting is **OFF**).

1. After entering Display Mode, press and release **POWER MODE** until the **BP.DATA** screen sequence appears.

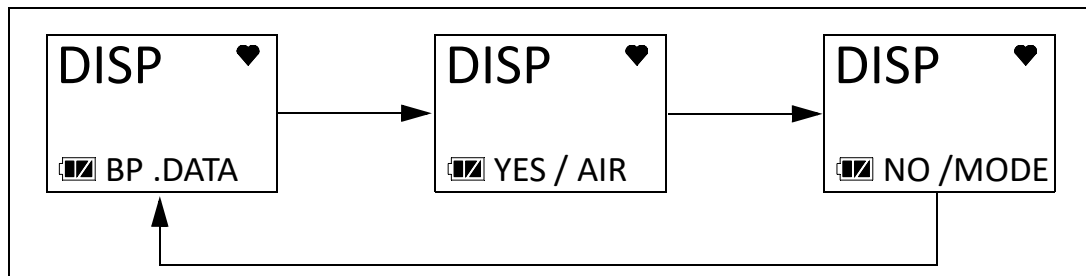

2. Press **AIR** to enter the **BP.DATA** screen. The date of the last successful bump test displays.

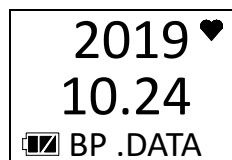

3. When you are done viewing the last bump test date, press and release **POWER MODE** to return to the **BP.DATA** screen in Display Mode.

Date/Time Screen (DATE)

The **DATE** screen shows the instrument's date and time.

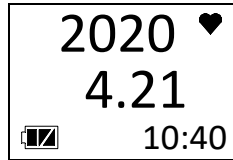

Temperature Screen (TEMP)

The **TEMP** screen shows the surrounding area's temperature.

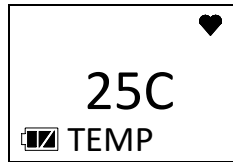

Alarm Points Screen (ALARM--P)

The Alarm Points Screen shows the gas alarm settings.

1. After entering Display Mode, press and release **POWER MODE** until the **ALARM--P** screen sequence appears.

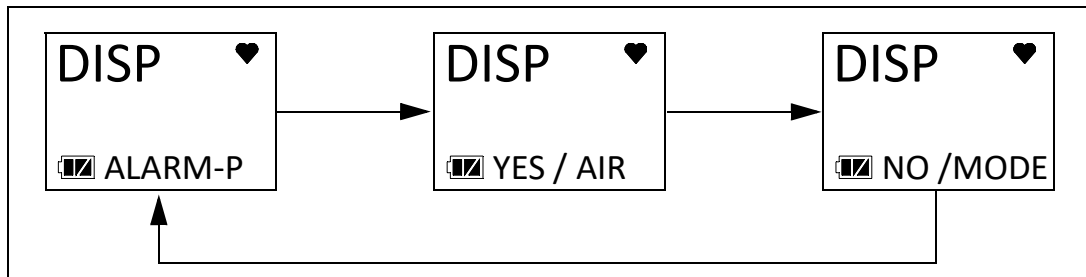

2. Press and release **AIR**. The Full Scale Setting screen appears.

- Use AIR to scroll through the Warning, Alarm, Alarm H, STEL, and TWA settings.

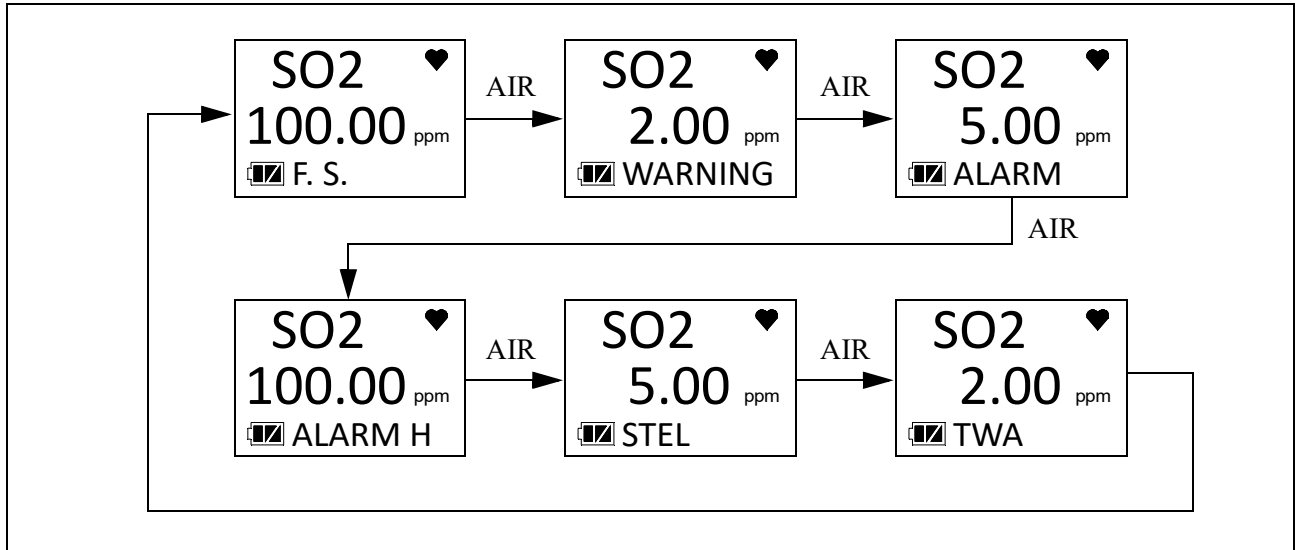

- While viewing the alarm settings for a particular alarm point, press and release AIR and POWER MODE at the same time to simulate the alarm conditions. The buzzer will sound, the LED will flash, and the instrument will vibrate just as it would if the displayed condition was actually happening.
- Press and release POWER MODE to return to the Alarm Points Screen.

Adjusting the Buzzer Volume (BUZZ.VOL)

The **BUZZ.VOL** screen allows you to adjust the volume of the instrument's buzzer. This screen only appears if **DISP.SET** in User Mode is set to **ON** (factory setting).

HI (factory setting): Buzzer volume is high.

LO: Buzzer volume is low.

- While in Display Mode, press and release POWER MODE until **BUZZ.VOL** appears. The current setting displays on the top line.

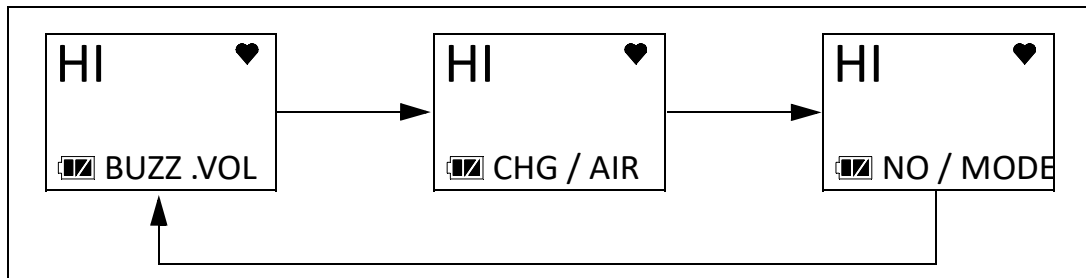

- Press and release AIR. The current setting flashes.
- Use AIR to display the desired setting.
- Press and release POWER MODE to save the setting and return to the **BUZZ.VOL** item in Display Mode.

Chapter 5: User Mode and Calibration

Overview

This section describes the SC-04 in User Mode. See Table 8 below for a list of the items found in User Mode, the page that the item’s instructions can be found on, and a short description of the item.

Table 8: User Mode Menu Items

User Mode Menu Item	Description			
BUMP (page 42)	Perform a bump test.			
	BUMP	Perform a bump test.		
	START	Begin the warmup sequence and enter Measuring Mode.		
	ESCAPE	Return to the BUMP menu item.		
GAS CAL (page 46)	Perform a fresh air adjustment, perform a span adjustment, change the calibration gas concentration.			
	AIR (page 46)	Perform a fresh air adjustment.		
	A-CAL (page 47) or E-CAL (page 51) depending on E-CAL User Mode setting	A-CAL (or E-CAL)	Perform a span adjustment.	
		START	Begin the warmup sequence and enter Measuring Mode.	
		CAL-P	Set the calibration gas concentration.	
		ESCAPE	Return to the A-CAL item in the GAS CAL menu.	
	ESCAPE	Return to the GAS CAL item in User Mode.		

Table 8: User Mode Menu Items

User Mode Menu Item	Description		
CAL SET (page 57)	Change parameters related to calibration.		
	CAL.RMDR (page 57)	<p><u>ON (factory setting)</u>: The instrument notifies the user upon startup when a calibration is due. Notification type depends on CAL.EXPD setting below. CAL.DATA screen appears in Display Mode.</p> <p><u>OFF</u>: No notification upon startup when a calibration is due. CAL.DATA screen does not appear in Display Mode.</p>	
	CAL.INT (page 57)	<p>How often the instrument needs to be calibrated.</p> <p>Options: 1 - 1000 days (factory setting is 90 days)</p>	
	CAL.EXPD (page 58)	<p>Defines what action must be taken if a calibration is due upon startup.</p> <p><u>CONFIRM (factory setting)</u>: Press and release AIR to acknowledge that calibration is due and continue to Measuring Mode.</p> <p><u>CANT.USE</u>: Cannot enter Measuring Mode until a successful calibration is performed.</p> <p><u>NONE</u>: A screen indicates that calibration is due but warmup sequence continues.</p>	
	ESCAPE	Return to the CAL SET item in User Mode.	
BUMP.SET (page 59)	Change parameters related to bump testing.		
	SETTING (page 59)	GAS.TIME	How long gas is applied during a bump test. Choices: 30 (factory setting), 45, 60, 90 seconds
		CHECK	Percentage of calibration gas concentration that the bump test reading must be within in order to pass bump. Options: 10%, 20%, 30%, 40%, 50% (factory setting)
		CAL.TIME	How long gas is applied during a calibration. GAS.TIME is deducted from this time. Options: 90 (factory setting) or 120 seconds
		A-CAL	<p><u>ON (factory setting)</u>: If a bump test fails, a calibration automatically starts.</p> <p><u>OFF</u>: If a bump test fails, a calibration does not automatically start.</p>
		ESCAPE	Return to the SETTING item in the BUMP SET menu.

Table 8: User Mode Menu Items

User Mode Menu Item	Description	
BUMP.SET (page 59) cont.	BP.RMDR (page 61)	<p><u>ON</u>: The instrument notifies the user upon startup when a bump test is due. Notification type depends on BP.EXPD setting below. BP.DATA screen appears in Display Mode.</p> <p><u>OFF (factory setting)</u>: No notification upon startup when a bump test is due. BP.DATA screen does not appear in Display Mode.</p>
	BP.INT (page 62)	<p>How often the instrument needs to be bump tested.</p> <p>Options: 0 - 30 days (factory setting is 30 days)</p>
	BP.EXPD (page 62)	<p>Defines what action must be taken if a bump test is due upon startup.</p> <p><u>CONFIRM (factory setting)</u>: Press and release AIR to acknowledge that bump test is due and continue to Measuring Mode.</p> <p><u>CANT.USE</u>: Cannot enter Measuring Mode until a successful bump test is performed.</p> <p><u>NONE</u>: A screen indicates that bump test is due but warmup sequence continues.</p>
	ESCAPE	<p>Return to the BUMP SET item in User Mode.</p>
ALARM-P (page 63)	<p>Set alarm points (WARNING, ALARM, ALARM H, STEL, TWA) and/or reset all alarms to their default settings.</p>	
LUNCH (page 65)	<p><u>ON</u>: Lunch break feature is on. Instrument asks if you want to resume TWA and PEAK readings at startup.</p> <p><u>OFF (factory setting)</u>: Lunch break feature is off. Instrument resets TWA and PEAK readings every time it's turned on.</p>	
BEEP (page 66)	<p>Set confirmation beep parameters.</p>	
	BEEP.SEL (page 66)	<p><u>LED</u>: LED flashes and instrument vibrates based on interval defined in BEEP.INT to confirm instrument is still operating.</p> <p><u>BUZZER</u>: Buzzer sounds and instrument vibrates based on interval defined in BEEP.INT to confirm instrument is still operating.</p> <p><u>LED+BUZ</u>: LED flashes, buzzer sounds, and instrument vibrates based on interval defined in BEEP.INT to confirm instrument is still operating.</p> <p><u>BMP/CAL</u>: LED flashes based on interval defined in BEEP.INT if bump test or calibration is due regardless of whether BP.RMDR and/or CAL.RMDR are set to ON.</p> <p><u>OFF (factory setting)</u>: No alerts to confirm instrument is still operating or that a bump test or calibration is due.</p>

Table 8: User Mode Menu Items

User Mode Menu Item	Description	
BEEP (page 66) cont.	BEEP.INT (page 67)	Confirmation alert interval. Confirmation type defined in BEEP.SEL. Options: 0.5 minute and 1 to 99 minutes in 1 minute increments. The factory setting is 5 minutes.
	ESCAPE	Return to the BEEP item in User Mode.
BL TIME (page 67)	How long the back light stays on after the last button press. Options: 0 - 255 seconds or OFF. The factory setting is 30 seconds.	
KEY.TONE (page 68)	<u>ON (factory setting)</u> : Buzzer sounds when button is pressed. <u>OFF</u> : Buzzer does not sound when button is pressed.	
DISP.SET (page 68)	<u>OFF</u> : USER ID, STN ID, and BUZZ.VOL items do not appear in Display Mode. <u>ON (factory setting)</u> : BUZZ.VOL item appears in Display Mode. USER ID and STN ID items appear if ID DISP in Maintenance Mode is also set to ON.	
ZERO.SUP (page 69)*	<u>ON (factory setting)</u> : Not intended for field adjustment. The suppression values are: Cl ₂ : 0.10 ppm HCN: 0.5 ppm NH ₃ : 4 ppm NO ₂ : 0.30 ppm PH ₃ : 0.02 ppm SO ₂ : 0.20 ppm	
ZERO.FLW (page 69)**	<u>ON (factory setting)</u> : Not intended for field adjustment.	
E-CAL (page 69)	<u>XX seconds</u> : E-CAL appears in GAS CAL instead of A-CAL. <u>OFF (factory setting)</u> : E-CAL does not appear in GAS CAL.	
DATE (page 70)	Set the instrument's date and time.	
PASS-W (page 70)	<u>ON</u> : User Mode is password-protected. Factory-set password is 0405. <u>OFF (factory setting)</u> : User Mode is not password-protected.	
ROM/SUM (page 71)	View the firmware information for the SC-04's sensor board and main board.	
START (page 71)	Press and release POWER MODE to begin the warmup sequence and enter Measuring Mode.	
* Only appears if ZSUP.DSP is set to ON in Maintenance Mode.		
** Only appears if ZFLW.DSP is set to ON in Maintenance Mode.		

Entering User Mode

WARNING: *The SC-04 is not in operation as a gas detector while in User Mode.*

1. Take the SC-04 to a non-hazardous location and turn it off if it is on.
2. Press and hold AIR, then press and hold POWER MODE. When you hear a beep, release the buttons.
3. The screen that appears depends on the setting of User Mode's **PASS-W** item.
If **PASS-W** is set to **OFF** (factory setting), continue with Step 6.
If **PASS-W** is set to **ON**, continue with Step 4.

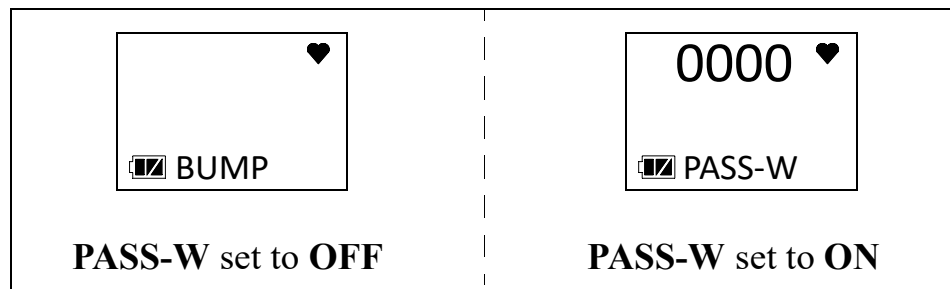

4. If **PASS-W** is set to **ON** in User Mode, a password screen appears and the first digit flashes. The factory-set password is **0405** but it can be changed.
5. Use AIR to select each password number then press POWER MODE to save it and move on to the next number. To go back a number, press and hold AIR and POWER MODE for a few seconds. To reverse the direction of change (ie. from increasing to decreasing or vice versa):
 - a. Press and hold AIR.
 - b. Immediately press POWER MODE and then release both buttons.
6. The **BUMP** item displays.



7. Use AIR to move through the User Mode items.

Tips for Using User Mode

- To scroll from one item to the next, press and release AIR. To reverse the scrolling direction:
 - a. Press and hold AIR.
 - b. Immediately press POWER MODE and then release both buttons.
 - c. The scrolling direction returns to the original direction when you exit and reenter a menu.
- To skip an item when a question is asked, press and release AIR.
- To enter an item and to save any changes, press and release POWER MODE.
- To change a flashing parameter, press and release AIR. To reverse the direction of change (ie. from increasing to decreasing or vice versa):
 - a. Press and hold AIR.
 - b. Immediately press POWER MODE and then release both buttons.
- To exit an entered item without saving a change, press and hold AIR and POWER MODE for a few seconds.

Performing a Bump Test (BUMP)

Bump test the instrument before each day's use with a known concentration of the target gas. The instrument does not need to be calibrated unless it does not pass the bump test.

To bump test the SC-04, you need:

- Calibration gas cylinder

Table 9: Calibration Concentration Limits

Channel	Min. Cal. Gas Concentration	Max. Cal. Gas Concentration
Ammonia	8 ppm	400 ppm
Chlorine	0.15 ppm	10.00 ppm
Hydrogen Cyanide	0.9 ppm	30.0 ppm
Nitrogen Dioxide	0.50 ppm	20.00 ppm
Phosphine	0.05 ppm	20.00 ppm
Sulfur Dioxide	0.50 ppm	100.00 ppm

- 0.25 LPM fixed flow regulator
 - Non-absorbent tubing
 - Calibration cup
1. Confirm that the SC-04's calibration gas value matches the concentration listed on the calibration gas cylinder as described on page 55.

2. Install the calibration cup onto the SC-04. Be sure the calibration cup is installed in the correct direction and that it is pushed on all the way.

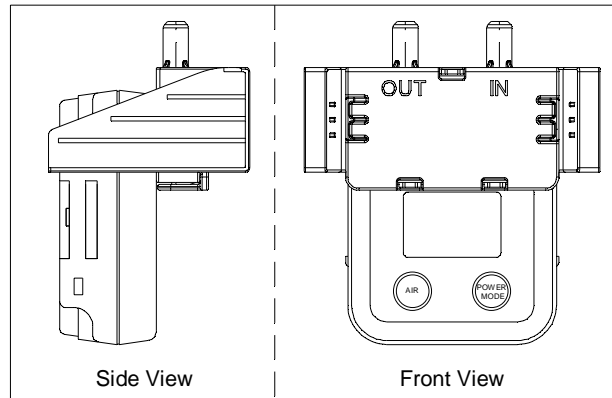

3. Use the tubing to connect the regulator to the inlet of the calibration cup (labeled “IN”).
4. While in User Mode, press AIR to scroll to **BUMP**.



5. Press and release POWER MODE. The display shows the gas and its assigned calibration value (see page 55 if the calibration value does not match the calibration gas cylinder’s concentration).

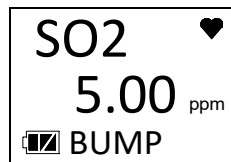

6. For toxic gas cylinders, it is important to vent the regulator while installing it onto the cylinder. Venting the regulator during installation helps prevent air from getting into the cylinder and degrading the gas. Open the regulator by turning the knob counterclockwise and install it onto the cylinder.
7. Press and release POWER MODE.
8. The gas reading flashes, the bottom of the screen alternates between “APLY” and “BUMP”, and the bottom of the screen counts down from the time set in **BUMP.SET\SETTING\GAS.TIME**.

To back out of the gas application screen without performing the bump test, press and release AIR and POWER MODE together.

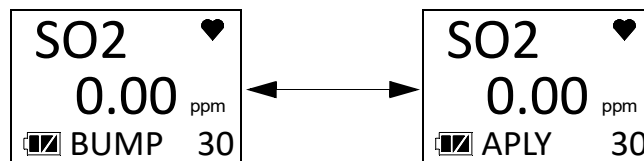

9. At the end of the countdown, the instrument analyzes the results. Follow the flow chart to determine the bump test outcome.

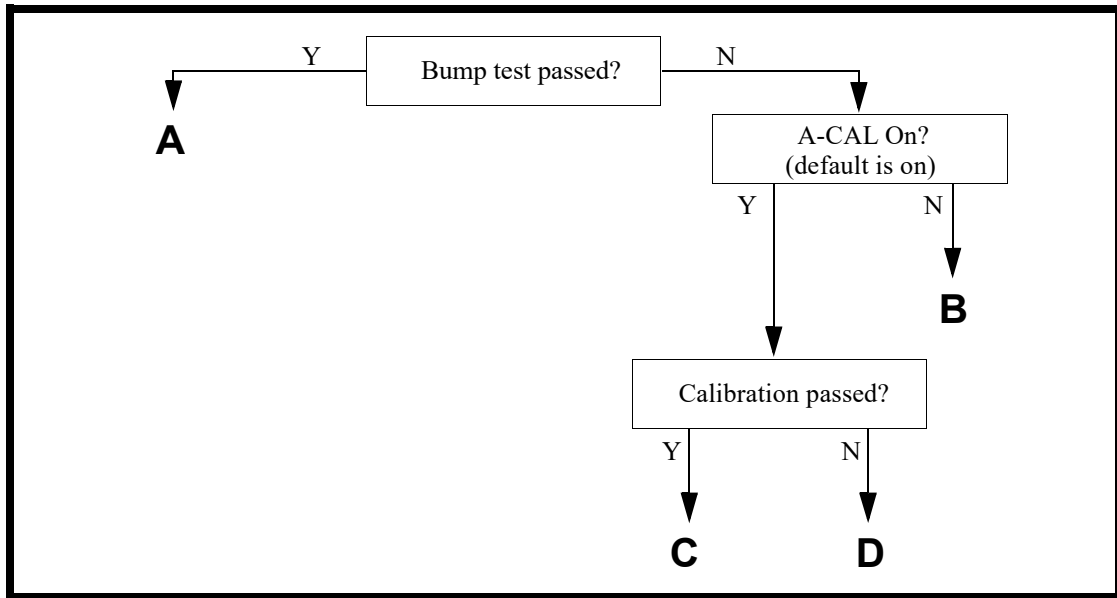
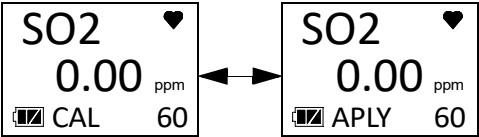
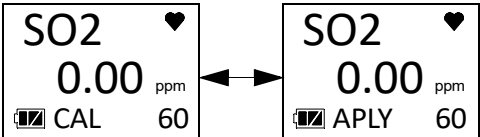
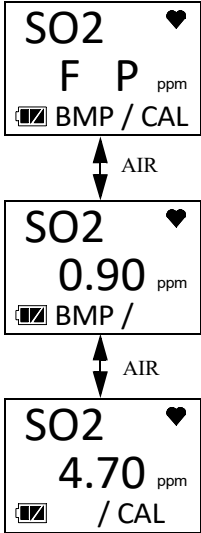
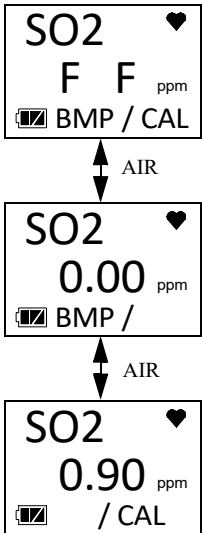

Figure 6: Bump Test Flow Chart

Option A from Flow Chart	Option B from Flow Chart
<ul style="list-style-type: none"> Bump test passed 	<ul style="list-style-type: none"> Bump test failed A-CAL set to OFF (factory setting is ON)
<ol style="list-style-type: none"> The instrument indicates that the channel passed the bump test. Use AIR to scroll between the bump test result and the bump test gas reading. 	<ol style="list-style-type: none"> The instrument shows which channels passed or failed the bump test. The LED flashes and the buzzer sounds. Use AIR to scroll between the result and the reading.
<ol style="list-style-type: none"> Close the regulator. Unscrew the regulator. Remove the calibration cup. Press and release POWER MODE to return to the BUMP screen in the BUMP menu. Use AIR to scroll to START and press and release POWER MODE to enter Measuring Mode. 	<ol style="list-style-type: none"> Close the regulator. Unscrew the regulator. Remove the calibration cup. Press and release POWER MODE to return to the BUMP screen in the BUMP menu. Use AIR to scroll to START and press and release POWER MODE to enter Measuring Mode. Calibrate the SC-04 as soon as possible.

Option C from Flow Chart	Option D from Flow Chart
<ul style="list-style-type: none"> • Bump test failed • A-CAL set to ON (factory setting) • Calibration passed 	<ul style="list-style-type: none"> • Bump test failed • A-CAL set to ON (factory setting) • Calibration failed
<ol style="list-style-type: none"> 1. A calibration immediately and automatically starts. Continue to apply the calibration gas. 2. The calibration time is the difference between the GAS.TIME and the CAL.TIME values defined in the BUMP.SET\SETTING item in User Mode. 	<ol style="list-style-type: none"> 1. A calibration immediately and automatically starts. Continue to apply the calibration gas. 2. The calibration time is the difference between the GAS.TIME and the CAL.TIME values defined in the BUMP.SET\SETTING item in User Mode.
	
<ol style="list-style-type: none"> 3. The instrument shows the pass/fail results of the bump test/calibration. Use AIR to scroll between the results and the readings. 	<ol style="list-style-type: none"> 3. The instrument shows the pass/fail results of the bump test/calibration. The LED flashes and the buzzer sounds. Use AIR to scroll between the results and the readings.
	
<ol style="list-style-type: none"> 4. Close the regulator. 5. Unscrew the regulator. 6. Remove the calibration cup. 7. Press and release POWER MODE to return to the BUMP screen in the BUMP menu. 8. Use AIR to scroll to START and press and release POWER MODE to enter Measuring Mode. 	<ol style="list-style-type: none"> 4. Close the regulator. 5. Unscrew the regulator. 6. Remove the calibration cup. 7. Press and release POWER MODE to return to the BUMP screen in the BUMP menu. 8. Use AIR to scroll to START and press and release POWER MODE to enter Measuring Mode.

Performing a Calibration (GAS CAL)

- Bump test the instrument before each day's use with a known concentration of the target gas. A bump test can be done in User Mode's **BUMP** item or by applying gas in Measuring Mode. The instrument does not need to be calibrated unless it does not pass the User Mode bump test or does not respond appropriately, as defined by the user, in Measuring Mode.
- To fully calibrate the sensor, you must do a fresh air adjustment (**AIR CAL**) and a span adjustment (**A-CAL** or **E-CAL**).
- The SC-04 can be calibrated using either **A-CAL** or **E-CAL** depending on the setting of the **E-CAL** User Mode item.
 - **A-CAL** (appears if **E-CAL** User Mode item is set to **OFF**): Apply gas for a period of time, then press and release **POWER MODE** to perform the adjustment.
 - **E-CAL** (appears if **E-CAL** User Mode item is set to something besides **OFF**): As soon as gas is applied and the reading reaches 10% of the auto calibration value, the instrument counts down from the number of seconds specified in the **E-CAL** User Mode item and automatically performs the adjustment.

Performing a Fresh Air Adjustment (AIR)

1. Find a fresh air environment, an environment of normal oxygen content (20.9%) that is free of toxic and combustible gases.
2. While in User Mode, press **AIR** to scroll to **GAS CAL**.



3. Press and release **POWER MODE**. The **AIR** item appears.



4. Press and release **POWER MODE** to enter the **AIR** menu.



5. To return to the **AIR** menu without performing a fresh air adjustment, press and release **POWER MODE**.

- To perform a fresh air adjustment, press and hold AIR until the screen prompts you to release it.

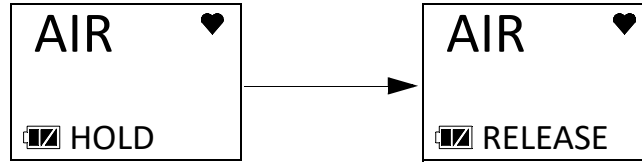

- If the fresh air adjustment passes, the instrument returns to the **AIR** item in the **GAS CAL** menu.
- If the fresh air adjustment fails, “FAIL AIR” displays. Press and release POWER MODE to acknowledge the failure. See page 72.

Performing a Span Adjustment in A-CAL

The **A-CAL** item only appears if **E-CAL** in User Mode is set to **OFF** (factory setting). If **E-CAL** is set to **ON**, see page 51 for calibration instructions.

Preparing for Span Adjustment

To adjust the span on the SC-04, you need:

- Calibration gas cylinder

Table 10: Calibration Concentration Limits

Channel	Min. Cal. Concentration	Max. Cal. Concentration
Ammonia	8 ppm	400 ppm
Chlorine	0.15 ppm	10.00 ppm
Hydrogen Cyanide	0.9 ppm	30.0 ppm
Nitrogen Dioxide	0.50 ppm	20.00 ppm
Phosphine	0.05 ppm	20.00 ppm
Sulfur Dioxide	0.50 ppm	100.00 ppm

- 0.25 LPM fixed flow regulator
 - Non-absorbent tubing
 - Calibration cup
1. Confirm that the SC-04’s calibration gas value matches the concentration listed on the calibration gas cylinder as described on page 55.

2. Install the calibration cup onto the SC-04. Be sure the calibration cup is installed in the correct direction and that it is pushed on all the way.

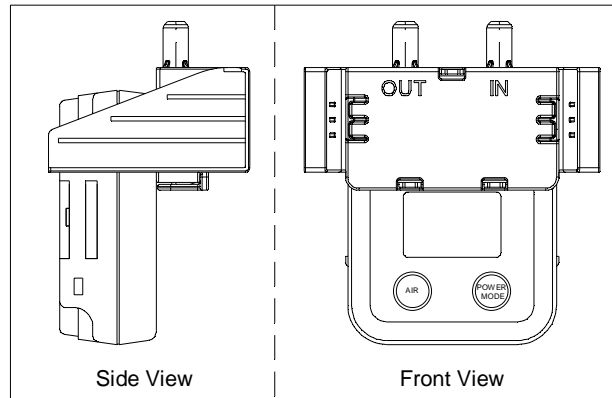

3. Use the tubing to connect the regulator to the inlet of the calibration cup (labeled “IN”).

Performing a Span Adjustment

1. While in User Mode, press AIR to scroll to **GAS CAL**.



2. Press and release POWER MODE. The **AIR** item appears.
3. Use AIR to scroll to the **A-CAL** item.



4. Press and release POWER MODE. The display shows the gas and its assigned calibration value (see page 55 if the calibration value does not match the calibration gas cylinder’s concentration).

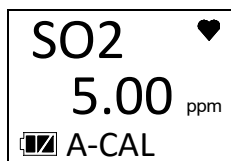

5. For toxic gas cylinders, it is important to vent the regulator while installing it onto the cylinder. Venting the regulator during installation helps prevent air from getting into the cylinder and degrading the gas. Open the regulator by turning the knob counterclockwise and install it onto the cylinder.
6. Press and release POWER MODE.

- The gas reading flashes and the bottom of the screen alternates between “APPLY” and “A-CAL”.

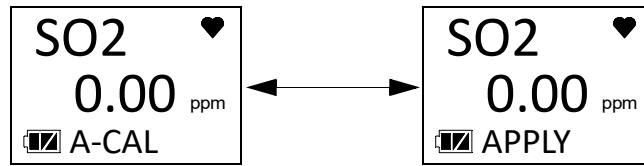

NOTE: To back out of the gas application screen without performing the calibration, press and release AIR and POWER MODE together.

- Turn the regulator knob counterclockwise to open the regulator.
- Allow the gas to flow for 1 minute for all gases except Cl₂ and NH₃. Allow Cl₂ and NH₃ gas to flow for 2 minutes.
- Press and release POWER MODE.

11. The table below describes the 2 calibration outcomes.

Calibration Passed	Calibration Failed
<p>1. The instrument indicates that the calibration passed.</p> <div data-bbox="462 342 659 478" style="border: 1px solid black; padding: 5px; text-align: center;"> <p>PASS ♥</p> <p>▣ A-CAL</p> </div> <p>2. The instrument shows the current gas reading.</p> <div data-bbox="462 573 659 709" style="border: 1px solid black; padding: 5px; text-align: center;"> <p>SO2 ♥</p> <p>5.10 ppm</p> <p>▣ A-CAL</p> </div> <p>3. If MAX.SPAN is set to ON (default is OFF, see page 100), the response reading's maximum adjustment is displayed. A maximum span of 10.00 ppm indicates that the reading could have been adjusted up to 10.00 ppm. If the maximum span value is close to the calibration gas value, the sensor should be replaced soon.</p> <p>The maximum adjustment is either twice the calibration value or full scale, whichever is lower.</p> <div data-bbox="462 1220 659 1356" style="border: 1px solid black; padding: 5px; text-align: center;"> <p>SO2 ♥</p> <p>10.00 ppm</p> <p>▣ MAX .SPAN</p> </div> <p>4. Close the regulator.</p> <p>5. The instrument continues to the START screen.</p> <p>6. Remove the calibration cup.</p> <p>7. Press and release POWER MODE to enter Measuring Mode.</p>	<p>1. The instrument indicates that the calibration failed.</p> <div data-bbox="950 342 1146 478" style="border: 1px solid black; padding: 5px; text-align: center;"> <p>SO2 ♥</p> <p>FAIL ppm</p> <p>▣ A-CAL</p> </div> <p>2. Close the regulator.</p> <p>3. Unscrew the regulator.</p> <p>4. Remove the calibration cup.</p> <p>5. Press and release POWER MODE to return to the A-CAL screen in the A-CAL menu.</p> <p>6. See “Troubleshooting” on page 72.</p>

Performing a Span Adjustment in E-CAL

The E-CAL item only appears if E-CAL in User Mode is set to **ON** (factory setting is **OFF**). If E-CAL is set to **OFF**, see page 47 for calibration instructions.

Preparing for Span Adjustment

To adjust the span on the SC-04, you need:

- Calibration gas cylinder

Table 11: Calibration Concentration Limits

Channel	Min. Cal. Concentration	Max. Cal. Concentration
Ammonia	8 ppm	400 ppm
Chlorine	0.15 ppm	10.00 ppm
Hydrogen Cyanide	0.9 ppm	30.0 ppm
Nitrogen Dioxide	0.50 ppm	20.00 ppm
Phosphine	0.05 ppm	20.00 ppm
Sulfur Dioxide	0.50 ppm	100.00 ppm

- 0.25 LPM fixed flow regulator
 - Non-absorbent tubing
 - Calibration cup
1. Confirm that the SC-04's calibration gas value matches the concentration listed on the calibration gas cylinder as described on page 55.
 2. Install the calibration cup onto the SC-04. Be sure the calibration cup is installed in the correct direction and that it is pushed on all the way.

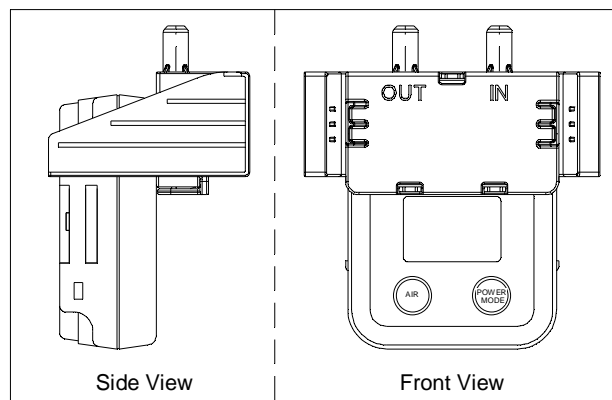

3. Use the tubing to connect the regulator to the inlet of the calibration cup (labeled “IN”).

Performing a Calibration

1. While in User Mode, press AIR to scroll to **GAS CAL**.



2. Press and release POWER MODE. The **AIR** item appears.
3. Use AIR to scroll to the **E-CAL** item.

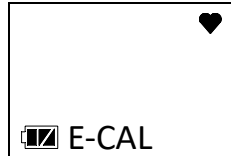

4. Press and release POWER MODE. The display shows the gas and its assigned calibration value (see page 55 if the calibration value does not match the calibration gas cylinder's concentration).

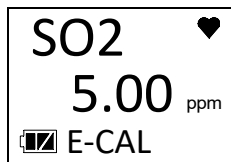

5. Press and release POWER MODE.
6. The gas reading flashes and the bottom of the screen says "GAS IN".

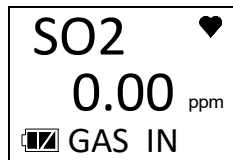

7. For toxic gas cylinders, it is important to vent the regulator while installing it onto the cylinder. Venting the regulator during installation helps prevent air from getting into the cylinder and degrading the gas. Open the regulator by turning the knob counterclockwise and install it onto the cylinder.

- Once the gas reading reaches 10% of the auto calibration value, the screen starts counting down from the time specified in the **E-CAL** User Mode item. In the example below, **E-CAL** is set to **60** seconds.

NOTE: RKI Instruments recommends an **E-CAL** setting of 120 seconds for Cl₂ and NH₃ and 60 seconds for all other gases.

To back out of the gas application screen without performing the calibration, press and release AIR and POWER MODE together.

If the reading never reaches 10% of the auto calibration value, press and release POWER MODE to fail the calibration.

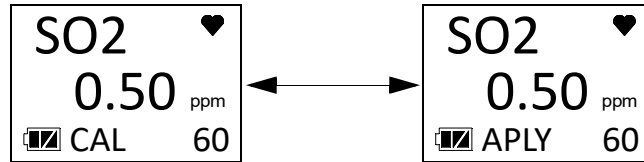

- At the end of the countdown, the instrument makes the span adjustment.

10. The table below describes the 2 calibration outcomes.

Calibration Passed	Calibration Failed
<p>1. The instrument indicates that the calibration passed.</p> <div data-bbox="406 342 602 478" style="border: 1px solid black; padding: 5px; text-align: center;"> <p>PASS ♥</p> <p>☑ E-CAL</p> </div> <p>2. The instrument shows the current gas reading.</p> <div data-bbox="406 573 602 709" style="border: 1px solid black; padding: 5px; text-align: center;"> <p>SO2 ♥</p> <p>5.10 ppm</p> <p>☑ E-CAL</p> </div> <p>3. If MAX.SPAN is set to ON (default is OFF, see page 100), the response reading's maximum adjustment is displayed. A maximum span of 10.00 ppm indicates that the reading could have been adjusted up to 10.00 ppm. If the maximum span value is close to the calibration gas value, the sensor should be replaced soon.</p> <p>The maximum adjustment is either twice the calibration value or full scale, whichever is lower.</p> <div data-bbox="406 1220 602 1356" style="border: 1px solid black; padding: 5px; text-align: center;"> <p>SO2 ♥</p> <p>10.00 ppm</p> <p>☑ MAX .SPAN</p> </div> <p>4. Close the regulator.</p> <p>5. The instrument continues to the START screen.</p> <p>6. Remove the calibration cup.</p> <p>7. Press and release POWER MODE to enter Measuring Mode.</p>	<p>1. The instrument indicates that the calibration failed.</p> <div data-bbox="893 342 1089 478" style="border: 1px solid black; padding: 5px; text-align: center;"> <p>SO2 ♥</p> <p>FAIL ppm</p> <p>☑ E-CAL</p> </div> <p>2. Close the regulator.</p> <p>3. Unscrew the regulator.</p> <p>4. Remove the calibration cup.</p> <p>5. Press and release POWER MODE to return to the E-CAL screen in the E-CAL menu.</p> <p>6. See “Troubleshooting” on page 72.</p>

Setting the Calibration Values in CAL--P

1. While in User Mode, press AIR to scroll to GAS CAL.



2. Press and release POWER MODE. The AIR item appears.
3. Use AIR to scroll to the A-CAL item (E-CAL if E-CAL in User Mode is set to ON).

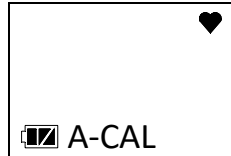

4. Press and release POWER MODE. The Auto Cal screen displays.

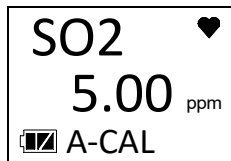

5. Use AIR to scroll to CAL--P.

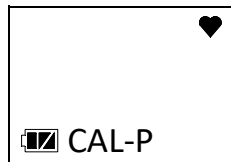

6. Press and release POWER MODE. The gas name displays.



7. Press and release POWER MODE. The calibration value begins to flash.



8. Use AIR to adjust the calibration gas value. The calibration gas value in the instrument must match the value listed on the calibration gas cylinder you are using. Limits on the calibration gas value are shown in the table below.

Table 12: Calibration Concentration Limits

Channel	Min. Cal. Concentration	Max. Cal Concentration
Ammonia	8 ppm	400 ppm
Chlorine	0.15 ppm	10.00 ppm
Hydrogen Cyanide	0.9 ppm	30.0 ppm
Nitrogen Dioxide	0.50 ppm	20.00 ppm
Phosphine	0.05 ppm	20.00 ppm
Sulfur Dioxide	0.50 ppm	100.00 ppm

9. Press and release POWER MODE to save the change. The calibration gas value stops flashing and the unit returns to the gas name screen.
10. Use AIR to scroll to **ESCAPE**.
11. Press and release POWER MODE to return to the **CAL--P** item in the **A-CAL** menu.
12. Press AIR to scroll to **ESCAPE**.
13. Press and release POWER MODE to return to the **A-CAL** item in the **GAS CAL** menu.
14. See “Exiting the GAS CAL Menu” on page 56 to return to User Mode.

Exiting the GAS CAL Menu

1. While in the **GAS CAL** menu, press AIR to scroll to **ESCAPE**.
2. Press and release POWER MODE to return to the **GAS CAL** item in User Mode.
3. See “Entering Measuring Mode (START)” on page 71 to enter Measuring Mode.

Setting Calibration Parameters (CAL SET)

The **CAL SET** menu has 4 items: **CAL.RMDR**, **CAL.INT**, **CAL.EXPD**, and **ESCAPE**.

1. While in User Mode, press AIR to scroll to **CAL SET**.



2. Press and release POWER MODE. The **CAL.RMDR** item appears.



CAL.RMDR

ON (factory setting): The SC-04 gives an indication at start up if it is due for calibration. The type of indication depends on the **CAL.EXPD** setting (see page 58).

OFF: The SC-04 does not give an indication at start up if it is due for calibration.

1. After entering the **CAL SET** menu, press AIR to scroll to **CAL.RMDR**.



2. Press and release POWER MODE. The current setting flashes.
3. Use AIR to display the desired setting.
4. Press and release POWER MODE to save the setting and return to the **CAL.RMDR** item in the **CAL SET** menu.
5. See “Exiting the CAL SET Menu” on page 58 to return to User Mode.

CAL.INT

This setting defines the amount of time between calibrations and can be set in 1 day increments. The minimum setting is 1 day and the maximum setting is 1000 days. The factory setting is 90 days.

1. After entering the **CAL SET** menu, press AIR to scroll to **CAL.INT**.



2. Press and release POWER MODE. The current setting flashes.
3. Use AIR to display the desired setting.
4. Press and release POWER MODE to save the setting and return to the **CAL.INT** item in the **CAL SET** menu.
5. See “Exiting the CAL SET Menu” on page 58 to return to User Mode.

CAL.EXPD

This item defines what indication is given during start up when calibration is due and **CAL.RMDR** is set to **ON** (factory setting).

CONFIRM (factory setting): The SC-04 gives an indication at start up if calibration is past due. Press and release AIR to continue without calibrating or press and release POWER MODE to enter User Mode and perform a calibration.

CANT.USE: The SC-04 gives an indication at start up that calibration is past due. Press and release POWER MODE to enter User Mode and perform a calibration. Pressing AIR has no effect. A successful calibration must be performed in order to use the instrument.

NONE: The SC-04 gives an indication at startup that calibration is past due. It is not necessary to acknowledge the indication. If desired, press POWER MODE to enter User Mode and perform a calibration. The warm-up sequence continues on its own.

1. After entering the **CAL SET** menu, press AIR to scroll to **CAL.EXPD**.



2. Press and release POWER MODE. The current setting flashes.
3. Use AIR to display the desired setting.
4. Press and release POWER MODE to save the setting and return to the **CAL.EXPD** item in the **CAL SET** menu.
5. See “Exiting the CAL SET Menu” on page 58 to return to User Mode.

Exiting the CAL SET Menu

1. While in the **CAL SET** menu, press AIR to scroll to **ESCAPE**.
2. Press and release POWER MODE to return to the **CAL SET** item in User Mode.
3. See “Entering Measuring Mode (START)” on page 71 to enter Measuring Mode.

Setting Bump Test Parameters (BUMP.SET)

The **BUMP.SET** menu has 5 items: **SETTING**, **BP.RMDR**, **BP.INT**, **BP.EXPD**, and **ESCAPE**.

1. While in User Mode, press AIR to scroll to **BUMP.SET**.



2. Press and release POWER MODE. The **SETTING** item appears.



SETTING

The **SETTING** menu has 5 items: **GAS.TIME**, **CHECK**, **CAL.TIME**, **A-CAL**, and **ESCAPE**.

1. After entering the **BUMP.SET** menu, press AIR to scroll to **SETTING**.



2. Press and release POWER MODE. The **GAS.TIME** item appears.

GAS.TIME

The **GAS.TIME** is the amount of time that the instrument is exposed to gas during a bump test. The available choices are **30** seconds (factory setting), **45** seconds, **60** seconds, and **90** seconds.

1. After entering the **SETTING** menu, press AIR to scroll to **GAS.TIME**.



2. Press and release POWER MODE. The current setting flashes.
3. Use AIR to display the desired setting.
4. Press and release POWER MODE to save the setting and return to the **GAS TIME** item in the **SETTING** menu.
5. See “Exiting the SETTING Menu” on page 61 to return to **BUMP.SET** menu.

CHECK

CHECK is the bump test tolerance value and is represented as a percentage of the calibration gas concentration. It is the percentage that the bump test reading can differ from the auto calibration value and still be considered a passed bump test. If the bump test reading differs more, the bump test fails. The available values are **10%**, **20%**, **30%**, **40%**, and **50%** (factory setting).

1. After entering the **SETTING** menu, press AIR to scroll to **CHECK**.



2. Press and release POWER MODE. The current setting flashes.
3. Use AIR to display the desired setting.
4. Press and release POWER MODE to save the setting and return to the **CHECK** item in the **SETTING** menu.
5. See “Exiting the SETTING Menu” on page 61 to return to **BUMP.SET** menu.

CAL.TIME

The **CAL.TIME** is the total time the instrument is exposed to calibration gas if **A-CAL** is set to **ON** and a bump test fails. The bump test time is deducted from the calibration time. For example, if the **CAL.TIME** is set to 90 seconds and the **GAS.TIME** is set to 30 seconds, if the bump test fails, the SC-04 is only exposed to gas for an additional 60 seconds. The available values are **90** seconds (factory setting), and **120** seconds.

1. After entering the **SETTING** menu, press AIR to scroll to **CAL.TIME**.



2. Press and release POWER MODE. The current setting flashes.
3. Use AIR to display the desired setting.
4. Press and release POWER MODE to save the setting and return to the **CAL.TIME** item in the **SETTING** menu.
5. See “Exiting the SETTING Menu” on page 61 to return to **BUMP.SET** menu.

A-CAL

ON (factory setting): If a bump test fails, the unit automatically begins a calibration.

OFF: If a bump test fails, the unit does not automatically begin a calibration.

1. After entering the **SETTING** menu, press AIR to scroll to **A-CAL**.

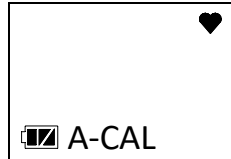

2. Press and release POWER MODE. The current setting flashes.
3. Use AIR to display the desired setting.
4. Press and release POWER MODE to save the setting and return to the **A-CAL** item in the **SETTING** menu.
5. See “Exiting the SETTING Menu” on page 61 to return to **BUMP.SET** menu.

Exiting the SETTING Menu

1. While in the **SETTING** menu, press AIR to scroll to **ESCAPE**.
2. Press and release POWER MODE to return to the **SETTING** item in the **BUMP.SET** menu.
3. See “Exiting the BUMP.SET Menu” on page 63 to return to User Mode.

BP.RMDR

ON: The SC-04 gives an indication at start up if it is due for bump testing. The type of indication depends on the **BP.EXPD** setting (see page 62). If the instrument is not due for bump testing, a check mark appears in the lower left corner of the LCD.

OFF (factory setting): The SC-04 does not give an indication at start up if it is due for bump testing.

1. After entering the **BUMP.SET** menu, press AIR to scroll to **BP.RMDR**.



2. Press and release POWER MODE. The current setting flashes.
3. Use AIR to display the desired setting.
4. Press and release POWER MODE to save the setting and return to the **BP.RMDR** item in the **BUMP.SET** menu.
5. See “Exiting the BUMP.SET Menu” on page 63 to return to User Mode.

BP.INT

This setting defines the amount of time between bump tests and can be set in 1 day increments. The minimum setting is **0** days and the maximum setting is **30** days (factory setting).

1. After entering the **BUMP.SET** menu, press AIR to scroll to **BP.INT**.

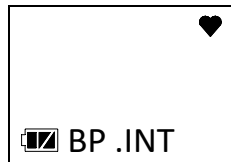

2. Press and release POWER MODE. The current setting flashes.
3. Use AIR to display the desired setting.
4. Press and release POWER MODE to save the setting and return to the **BP.INT** item in the **BUMP.SET** menu.
5. See “Exiting the BUMP.SET Menu” on page 63 to return to User Mode.

BP.EXPD

This item defines what indication is given during start up when a bump test is due and **BP.RMDR** is set to **ON** (factory setting is **OFF**).

CONFIRM (factory setting): The SC-04 gives an indication at start up if a bump test is past due. Press and release AIR to continue without bump testing or press and release POWER MODE to enter User Mode and perform a bump test.

CANT.USE: The SC-04 gives an indication at start up that a bump test is past due. Press and release POWER MODE to enter User Mode and perform a bump test. Pressing AIR has no effect. A successful bump test must be performed in order to use the instrument.

NONE: The SC-04 gives an indication at startup that a bump test is past due. It is not necessary to acknowledge the indication. If desired, press POWER MODE to enter User Mode and perform a bump test. The warm-up sequence continues on its own.

1. After entering the **BUMP.SET** menu, press AIR to scroll to **BP.EXPD**.



2. Press and release POWER MODE. The current setting flashes.
3. Use AIR to display the desired setting.
4. Press and release POWER MODE to save the setting and return to the **BP.EXPD** item in the **BUMP.SET** menu.
5. See “Exiting the BUMP.SET Menu” on page 63 to return to User Mode.

Exiting the **BUMP.SET** Menu

1. While in the **BUMP.SET** menu, press AIR to scroll to **ESCAPE**.
2. Press and release POWER MODE to return to the **BUMP.SET** item in User Mode.
3. See “Entering Measuring Mode (START)” on page 71 to enter Measuring Mode.

Alarm Settings (**ALARM--P**)

The **ALARM--P** menu has 3 items: **ALARM--P**, **DEF.ALMP**, and **ESCAPE**.

1. While in User Mode, press AIR to scroll to **ALARM--P**.



2. Press and release POWER MODE. The first screen displays.



Setting the Alarm Points

1. After entering the **ALARM-P** menu, press AIR to scroll to the gas name.

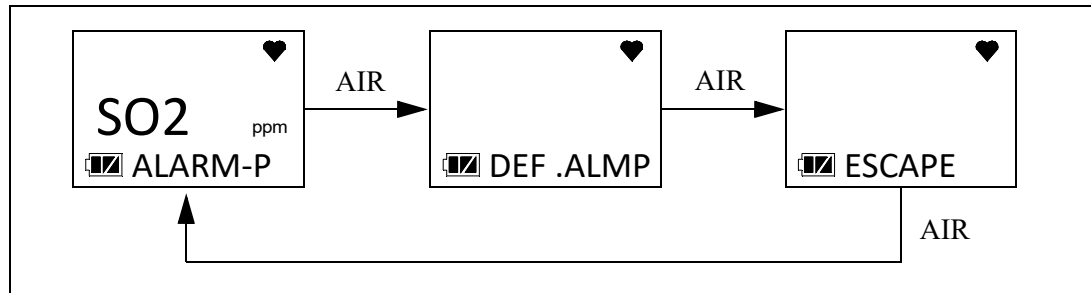

2. Press and release POWER MODE.

3. The Warning setpoint flashes.

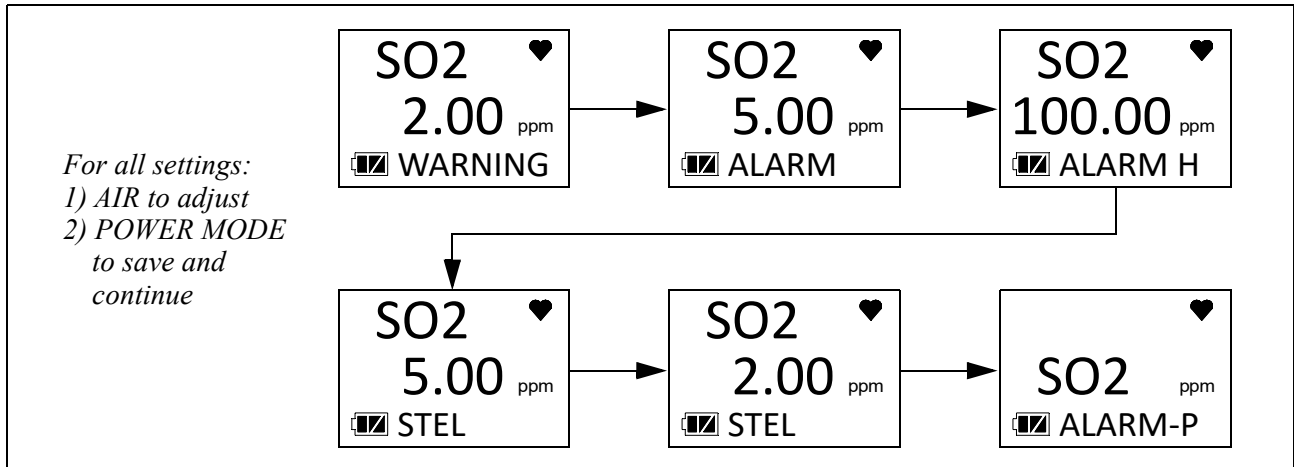

4. Use AIR to adjust the Warning setpoint. The alarm setpoint limitations are shown in the table below.

Channel	Alarm Point Limitations
Cl ₂	0.15 ppm ≤ WARNING ≤ ALARM ≤ ALARM H ≤ 20.00 ppm
HCN	0.9 ppm ≤ WARNING ≤ ALARM ≤ ALARM H ≤ 30.0 ppm
NH ₃	8.0 ppm ≤ WARNING ≤ ALARM ≤ ALARM H ≤ 400.0 ppm
NO ₂	0.50 ppm ≤ WARNING ≤ ALARM ≤ ALARM H ≤ 20.00 ppm
PH ₃	0.05 ppm ≤ WARNING ≤ ALARM ≤ ALARM H ≤ 20.00 ppm
SO ₂	0.50 ppm ≤ WARNING ≤ ALARM ≤ ALARM H ≤ 100.00 ppm

5. Press and release POWER MODE to save the setting.
6. Repeat Step 4 and Step 5 for the Alarm, Alarm H, STEL and TWA settings.
7. The instrument returns to the channel selection screen.
8. See “ESCAPE” on page 65 to return to User Mode.

Defaulting the Alarm Points

Defaulting the alarm points defaults them back to factory settings as outlined in Table 2 on page 8 or to the settings saved in the **SAVE-AP** item in Gas Select Mode if you performed a **SAVE-AP** operation.

1. After entering the **ALARM-P** menu, press AIR to scroll to **DEF.ALMP**.



2. Press POWER MODE to enter the **DEF.ALMP** item.
3. Press POWER MODE to perform an alarm default. Press AIR to return to the **DEF.ALMP** item in the **ALARM-P** menu.
4. The instrument asks if you're sure you want to default the alarm points.
5. Press POWER MODE to default the alarm points. Press AIR to return to the **DEF.ALMP** item in the **ALARM-P** menu.
6. See "ESCAPE" on page 65 to return to User Mode.

ESCAPE

1. While in the **ALARM-P** menu, press AIR to scroll to **ESCAPE**.
2. Press and release POWER MODE to return to the **ALARM--P** item in User Mode.
3. See "Entering Measuring Mode (START)" on page 71 to enter Measuring Mode.

Updating the Lunch Break Setting (LUNCH)

OFF (factory setting): The SC-04 automatically starts new TWA and PEAK reading collection and resets the time in operation at startup.

ON: The Lunch Break Screen displays during startup. From this screen, you can choose to continue accumulating TWA and PEAK readings and the time in operation from the last time the SC-04 was used or start collecting new readings and reset the time in operation.

1. While in User Mode, press AIR to scroll to **LUNCH**.



2. Press and release POWER MODE. The current setting flashes.
3. Use AIR to display the desired setting.
4. Press and release POWER MODE to save the setting and return to the **LUNCH** item in User Mode.
5. See "Entering Measuring Mode (START)" on page 71 to enter Measuring Mode.

Setting the Confirmation Beep and Non-Compliance Indicator (BEEP)

The **BEEP** menu has 3 items: **BEEP.SEL**, **BEEP.INT**, and **ESCAPE**.

1. While in User Mode, press AIR to scroll to **BEEP**.



2. Press and release POWER MODE. The **BEEP.SEL** item appears.



BEEP.SEL

BEEP.SEL defines what kind of confirmation or non-compliance indication you want to occur in Measuring Mode. The available choices are:

OFF (factory setting): The SC-04 does not provide a confirmation alert or non-compliance indicator.

LED: The SC-04's LED double flashes as often as defined by the **BEEP.INT** parameter to verify that the instrument is operating.

BUZZER: The SC-04's buzzer double beeps as often as defined by the **BEEP.INT** parameter to verify that the instrument is operating.

LED+BUZ: The SC-04's LED double flashes and the buzzer double beeps as often as defined by the **BEEP.INT** parameter to verify that the instrument is operating.

BMP/CAL: If a bump test or a calibration is due and if **BP.EXPD** or **CAL.EXPD** is set to **CONFIRM** (factory setting) or **NONE**, the SC-04's LED double flashes as often as defined by the **BEEP.INT** parameter to indicate a non-compliance. Once a bump test or calibration (depending on which is due) is done, the LED stop flashing.

1. While in the **BEEP** menu, press AIR to scroll to **BEEP.SEL**.



2. Press and release POWER MODE. The current setting flashes.
3. Use AIR to display the desired setting.

4. Press and release **POWER MODE** to save the setting and return to the **BEEP.SEL** item in the **BEEP** menu.
5. See “**ESCAPE**” on page 67 to return to User Mode.

BEEP.INT

The **BEEP.INT** parameter defines how often the confirmation alert or non-compliance indicator selected in **BEEP.SEL** occurs. This setting only applies if the **BEEP.SEL** parameter is set to something other than **OFF** (factory setting). The available choices are **0.5** minutes and **1-99** minutes in 1 minute increments. The factory setting is **5** minutes.

1. While in the **BEEP** menu, press **AIR** to scroll to **BEEP.INT**.



2. Press and release **POWER MODE**. The current setting flashes.
3. Use **AIR** to display the desired setting.
4. Press and release **POWER MODE** to save the setting and return to the **BEEP.INT** item in the **BEEP** menu.
5. See “**ESCAPE**” on page 67 to return to User Mode.

ESCAPE

1. While in the **BEEP** menu, press **AIR** to scroll to **ESCAPE**.
2. Press and release **POWER MODE** to return to the **BEEP** item in User Mode.
3. See “**Entering Measuring Mode (START)**” on page 71 to enter Measuring Mode.

Updating the Backlight Time (BL TIME)

This setting defines how long the LCD backlight stays on when you press any button. The minimum setting is **OFF**; the maximum setting is **255** seconds. The factory setting is **30** seconds.

1. While in User Mode, press **AIR** to scroll to **BL TIME**.



2. Press and release **POWER MODE**. The current setting flashes.
3. Use **AIR** to display the desired setting.

4. Press and release POWER MODE to save the setting and return to the **BL TIME** item in User Mode.
5. See “Entering Measuring Mode (START)” on page 71 to enter Measuring Mode.

Turning the Key Tone On/Off (KEY.TONE)

ON (factory setting): The instrument beeps when a button is pressed.

OFF: The instrument does not beep when a button is pressed.

1. While in User Mode, press AIR to scroll to **KEY.TONE**.



2. Press and release POWER MODE. The current setting flashes.
3. Use AIR to display the desired setting.
4. Press and release POWER MODE to save the setting and return to the **KEY.TONE** item in User Mode.
5. See “Entering Measuring Mode (START)” on page 71 to enter Measuring Mode.

Display Mode Items (DISP.SET)

OFF: **USER ID**, **STN ID**, and **BUZZ.VOL** screens do not appear in Display Mode.

ON (factory setting): **BUZZ.VOL** screen appears in Display Mode. **USER ID** and **STN ID** screens appear in Display Mode if **ID DISP** in Maintenance Mode is also set to **ON** (factory setting is **OFF**).

1. While in User Mode, press AIR to scroll to **DISP.SET**.



2. Press and release POWER MODE. The current setting flashes.
3. Use AIR to display the desired setting.
4. Press and release POWER MODE to save the setting and return to the **DISP.SET** item in User Mode.
5. See “Entering Measuring Mode (START)” on page 71 to enter Measuring Mode.

Zero Suppression (ZERO.SUP)

This item only appears if **ZSUP.DSP** is set to **ON** in Maintenance Mode (factory setting is **OFF**). The **ZERO.SUP** setting is not intended for field adjustment. The default setting is **ON**.

Sensor	Zero Suppression Value
Cl ₂	0.10 ppm
HCN	0.5 ppm
NH ₃	4 ppm
NO ₂	0.30 ppm
PH ₃	0.02 ppm
SO ₂	0.20 ppm

Zero Follower (ZERO.FLW)

This item only appears if **ZFLW.DSP** is set to **ON** in Maintenance Mode (factory setting is **OFF**). The **ZERO.FLW** setting is not intended for field adjustment. The default setting is **ON**.

Turning Easy Calibration On/Off (E-CAL)

OFF (factory setting): Auto Calibration (**A-CAL**) item appears in **GAS CAL** menu instead of Easy Calibration (**E-CAL**).

XX seconds: Easy Calibration (**E-CAL**) item appears in **GAS CAL** menu instead of Auto Calibration (**A-CAL**). During a calibration, the instrument counts down from the number of seconds you select.

NOTE: RKI Instruments recommends an **E-CAL** setting of 120 seconds for Cl₂ and NH₃ and 60 seconds for all other gases.

1. While in User Mode, press AIR to scroll to **E-CAL**.

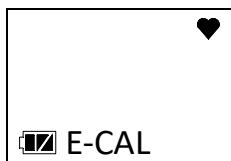

2. Press and release POWER MODE. The current setting flashes.
3. Use AIR to display the desired setting.

4. Press and release POWER MODE to save the setting and return to the **E-CAL** item in User Mode.
5. See “Entering Measuring Mode (START)” on page 71 to enter Measuring Mode.

Setting the Date/Time (DATE)

1. While in User Mode, place the cursor next to **DATE**.



2. Press and release POWER MODE. The date and time display with the year flashing.

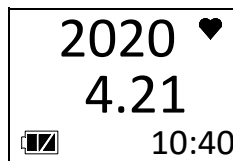

3. Use AIR to display the desired year.
4. Press and release POWER MODE to save the setting. The month setting flashes.
5. Repeat Step 3 and Step 4 to enter the month, day, hours, and minutes settings. The date and time are saved and the instrument returns to the **DATE** item in User Mode.
6. See “Entering Measuring Mode (START)” on page 71 to enter Measuring Mode.

Turning the Password On/Off (PASS-W)

ON: The SC-04 prompts you for a password when you enter User Mode. The factory-set password is **0405** but it can be changed.

OFF (factory setting): No password is required to enter User Mode.

1. While in User Mode, press AIR to scroll to **PASS-W**.

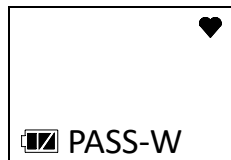

2. Press and release POWER MODE. The current setting flashes.
3. Use AIR to display the desired setting.
4. If you selected **OFF**, press and release POWER MODE to save the setting and return to the **PASS-W** item in User Mode.

If you selected **ON**, continue with Step 5.

5. Press and release POWER MODE. The Set Password Screen appears. The current password appears and the first digit flashes.

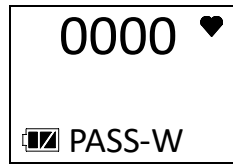

6. Use AIR to display a number from 0 to 9.
7. Press and release POWER MODE to enter the selection and advance to the next number. To go back a number, press and hold AIR and POWER MODE for a few seconds.
8. Repeat Step 6 and Step 7 to select the remaining numbers. When you press and release POWER MODE to enter the last number, the password is saved and the instrument returns to the **PASS-W** item in User Mode.
9. See “Entering Measuring Mode (START)” on page 71 to enter Measuring Mode.

Viewing the ROM/SUM (ROM/SUM)

The **ROM/SUM** screen shows the instrument’s firmware version and firmware checksum.

1. While in User Mode, press AIR to scroll to **ROM/SUM**.

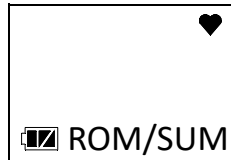

2. Press and release POWER MODE. The screen shows the ROM/SUM. The ROM is the top value and the SUM is the bottom value.

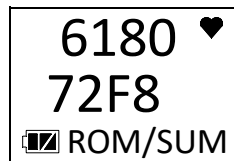

3. Press and release POWER MODE to return to the **ROM/SUM** item in User Mode.
4. See “Entering Measuring Mode (START)” on page 71 to enter Measuring Mode.

Entering Measuring Mode (START)

1. While in User Mode, press AIR to scroll to **START**.



2. Press and release POWER MODE. The instrument begins its warmup sequence.

Chapter 6: Maintenance

Overview

This chapter describes troubleshooting procedures for the SC-04. It also includes procedures for replacing the batteries and replacing various consumable parts.

WARNING: *RKI Instruments recommends that service, calibration, and repair of RKI gas detectors be performed by personnel properly trained for this work. Replacing the sensor and other parts with original equipment does not affect the intrinsic safety of the instrument.*

AVERTISSEMENT: *RKI Instruments recommande que le service, l'étalonnage et la réparation des détecteurs de gaz RKI soient effectués par du personnel dûment formé à ces travaux. Le remplacement du capteur et d'autres pièces par l'équipement d'origine n'affecte pas la sécurité intrinsèque de l'instrument.*

Troubleshooting

The troubleshooting table describes error messages, symptoms, probable causes, and recommended action for problems you may encounter with the SC-04.

Table 13: Troubleshooting the SC-04

Symptoms	Probable Causes	Recommended Action
<ul style="list-style-type: none">The LCD is blank.	<ul style="list-style-type: none">The unit got turned off.The batteries needs to be replaced.The battery cover may not be completely closed.	<ol style="list-style-type: none">To turn on the unit, press and briefly hold POWER MODE.Replace the batteries.Be sure the battery cover is completely closed and that the screw is tight.If the difficulties continue, contact RKI Instruments, Inc. for further instruction.

Table 13: Troubleshooting the SC-04

Symptoms	Probable Causes	Recommended Action
<ul style="list-style-type: none"> The LCD shows an abnormally high reading but other gas detection instruments do not. 	<ul style="list-style-type: none"> Sensor filter needs to be replaced. The SC-04 needs to be recalibrated. The sensor needs replacement. 	<ol style="list-style-type: none"> Replace the sensor filter. Recalibrate the unit. If the difficulties continue, replace the sensor and calibrate. Allow instruments with NH₃ sensors 2 hours of sensor warmup prior to operation if the sensor or batteries are newly installed or if the unit's batteries have been completely discharged. If the difficulties continue, contact RKI Instruments, Inc. for further instruction.
<ul style="list-style-type: none"> Calibration fails. 	<ul style="list-style-type: none"> The calibration value does not match the cylinder gas concentration. The sample gas is not reaching the sensor because of a bad connection. The calibration cylinder is out of gas or is outdated. The sensor needs replacement. 	<ol style="list-style-type: none"> Make sure the SC-04 has been properly set up for calibration. Check all calibration tubing for leaks or for any bad connections. Verify that the calibration cylinder contains an adequate supply of fresh test sample. If the fail condition continues, replace the sensor. If the difficulties continue, contact RKI Instruments, Inc. for further instruction.
<ul style="list-style-type: none"> Heart symbol at the top of the screen becomes steadily on or disappears. 	<ul style="list-style-type: none"> A microprocessor error has occurred. 	<ul style="list-style-type: none"> Contact RKI Instruments, Inc. for further instruction.

Replacing the Batteries (Alkaline or Ni-MH)

WARNING: To prevent ignition of a hazardous atmosphere, batteries must only be changed in an area known to be nonhazardous.

AVERTISSEMENT: Pour éviter l'inflammation d'une atmosphère dangereuse, la batterie ne doit être remplacée que dans une zone non dangereuse.

WARNING: Use only Duracell MN2400 or PC2400 or Eneloop BK-4MCC batteries to maintain the QPS classification of the SC-04. Use of other batteries will void the QPS classification and may void the warranty. Do not mix old/new or different types of batteries.

AVERTISSEMENT: Utiliser uniquement des piles Duracell MN 2400 ou PC 2400 ou Eneloop BK-4MCC de maintenir la classification QPS de la SC-04. L'utilisation d'autres piles annule la classification QPS et peut annuler la garantie. Ne mélangez pas les anciennes/nouvelles ou différents types de piles.

NOTE: If old batteries are completely out of charge (the unit does not power on), instruments with NH₃ sensors require 2 hours for sensor warmup before turning the instrument on for normal operation.

Replace the batteries when the last bar in the battery icon is flashing.

1. Make sure the SC-04 is off.
2. Release the side of the alligator or belt clip that is opposite the hinge. You may need to use a screwdriver to pry it open.

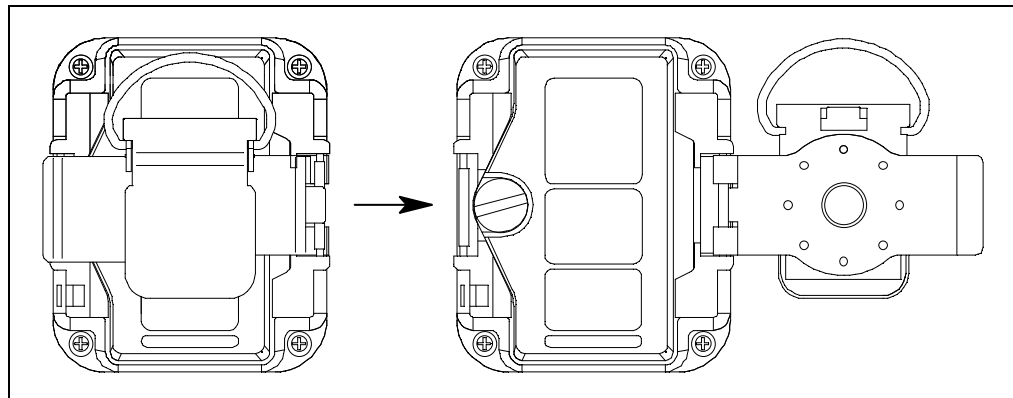

Figure 7: Releasing the Alligator or Belt Clip

3. Rotate the captive battery cover screw counterclockwise.

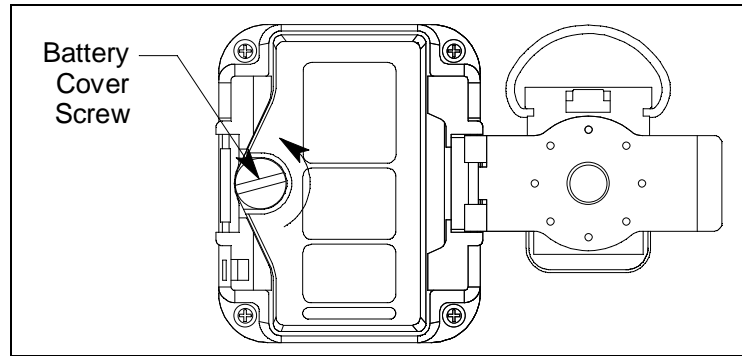

Figure 8: Unscrew Battery Cover Screw

4. Remove the battery cover.
5. Remove the old batteries.

NOTE: New batteries must be installed within 5 minutes to avoid having to reset the date/time.

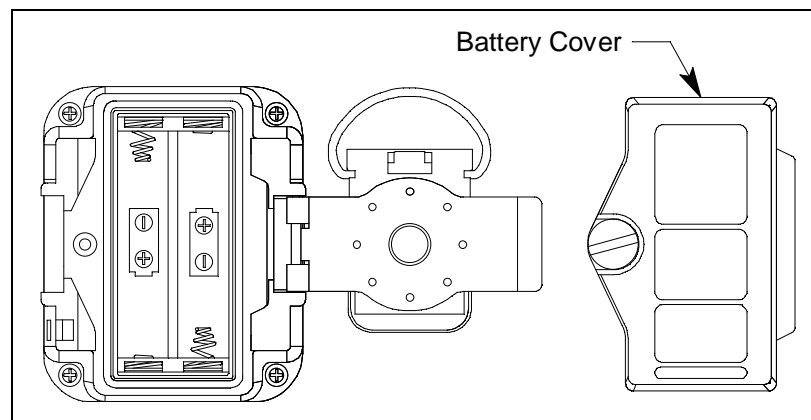

Figure 9: Battery Cover Removal

6. Install the new AAA batteries. Follow the diagram shown in the battery compartment.

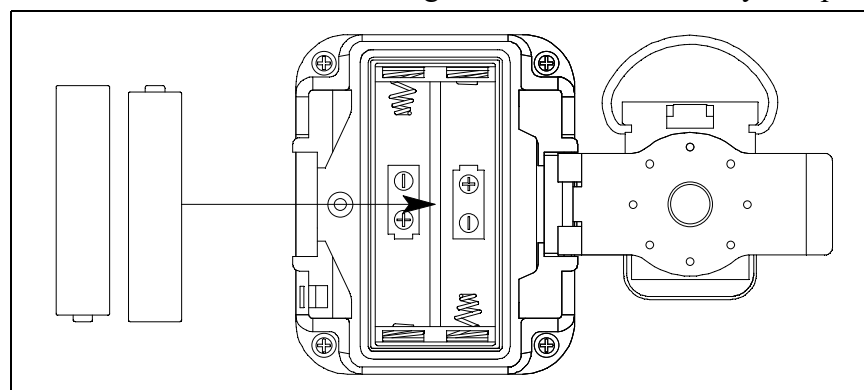

Figure 10: Installing New Batteries

7. Reinstall the battery cover and tighten the battery cover screw.

8. If the instrument has been without batteries for more than 5 minutes, the date and time are reset and need to be set again. When the new batteries are installed, the instrument automatically turns on and displays the Date/Time Screen. Set the date and time as described on page 70. Once the date and time are set, the instrument begins its warmup sequence. If you do not set the date and time within 30 seconds, the instrument automatically begins its warmup sequence.

Recharging the Batteries (Ni-MH Batteries Only)

Any battery charger capable of charging AAA Ni-MH batteries can be used to recharge the SC-04's Ni-MH batteries. RKI Instruments, Inc. recommends using one of the chargers specified on page 83.

WARNING: *To prevent ignition of a hazardous atmosphere, batteries must only be charged in an area known to be nonhazardous.*

NOTE: If old batteries have been completely discharged (the unit does not power on), instruments with NH₃ sensors require 2 hours for sensor warmup before turning the instrument on for normal operation.

1. Remove the batteries from the SC-04 as described in Step 1 - Step 5 on page 74.
2. Install the Ni-MH batteries in the charger. See the battery charger's manual for charging instructions.
3. Put the batteries back in the SC-04 and reinstall the battery cover.

Replacing the Sensor Filter

NO₂ and SO₂ Sensors' Filter: The H₂S filter disk is tan in color. The filter should be replaced every 6 months.

HCN Sensor Filter: The H₂S filter disk is dark gray in color. The filter should be replaced every 6 months.

PH₃ Sensor Filter: The humidity filter disk is white in color. The filter should be replaced every 6 months.

NH₃ Sensor Filter: The humidity filter is white in color. The filter should be replaced every 6 months.

1. Verify that the SC-04 is off.
2. Remove the rubber boot, if installed.

3. Use a small Phillips screwdriver to unscrew the 4 screws that attached the front case to the rear case.

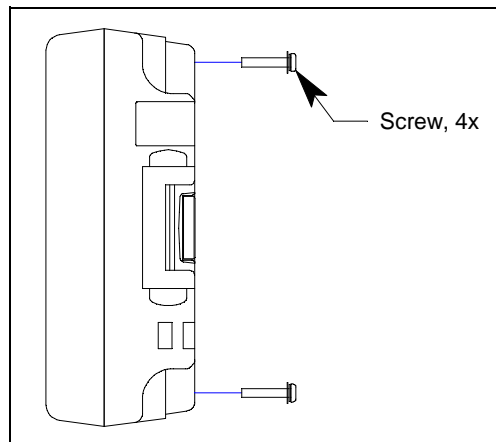

Figure 11: Unscrewing Case Screws

4. Turn the instrument right side up. The screws are not captive and may fall out. Be sure not to lose them.
5. Remove the front case from the rear case.

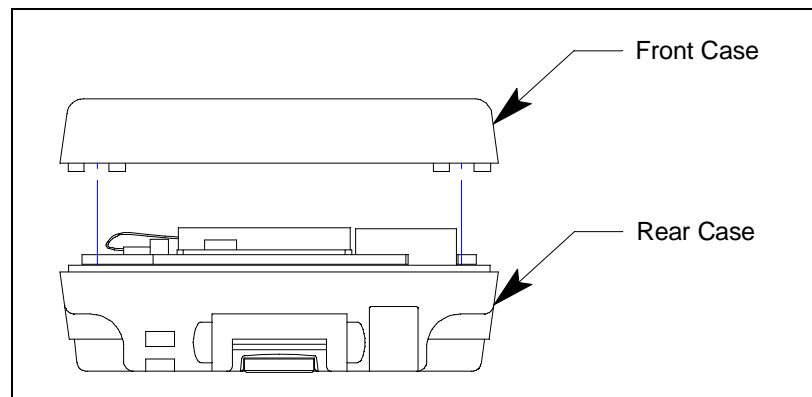

Figure 12: Case Separation

6. Turn the front case upside down.
7. If the sensor stayed in the front case, remove the sensor.

8. The sensor filter sits in the middle of a black gasket. Pry the sensor filter out of the gasket.

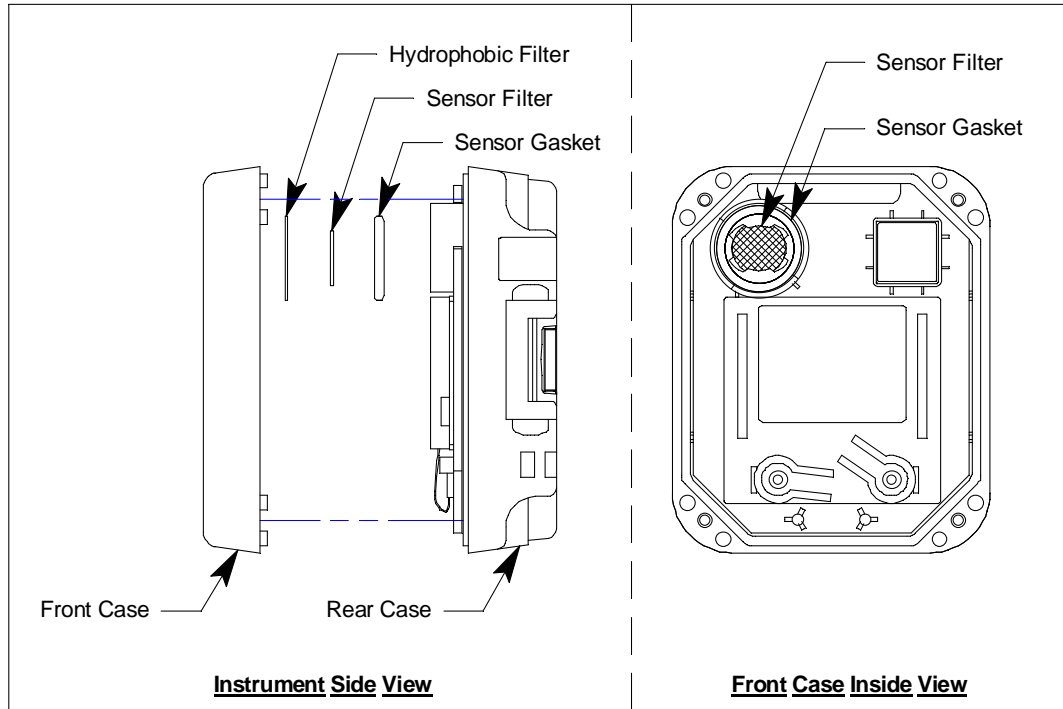

Figure 13: Sensor Filter Location

9. Install a new sensor filter. If the gasket got removed, install it with the flat side facing the white hydrophobic filter.
10. If necessary, put the sensor in the socket on the rear case. The colored side faces away from the rear case and the slots in the sensor line up with tabs in the socket.

CAUTION: Forcing a sensor into a socket without lining the sensor slots up with the socket tabs may damage the sensor or socket.

11. Reinstall the front case to the rear case.
12. Reinstall the 4 screws that were removed in Step 3.
13. Reinstall the rubber boot, if being used.

Replacing the Hydrophobic Filter

1. Verify that the SC-04 is off.
2. Remove the rubber boot, if installed.
3. Use a small Phillips screwdriver to unscrew the 4 screws that attached the front case to the rear case.

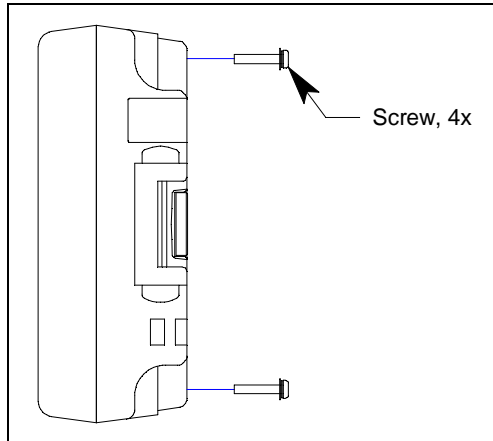

Figure 14: Unscrewing Case Screws

4. Turn the instrument right side up. The screws are not captive and may fall out. Be sure not to lose them.
5. Remove the front case from the rear case.

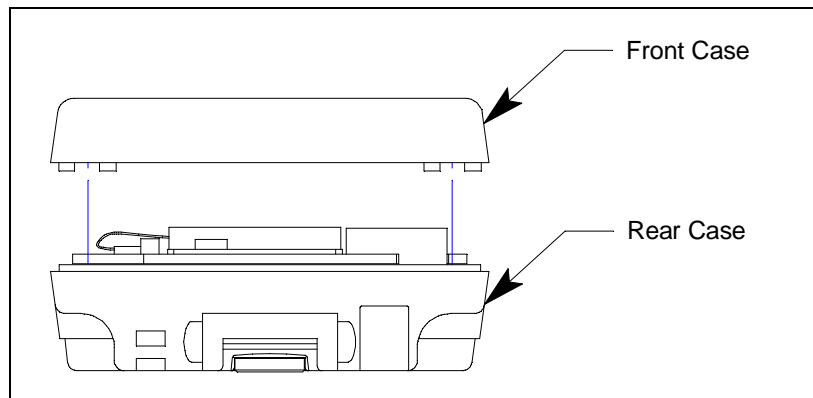
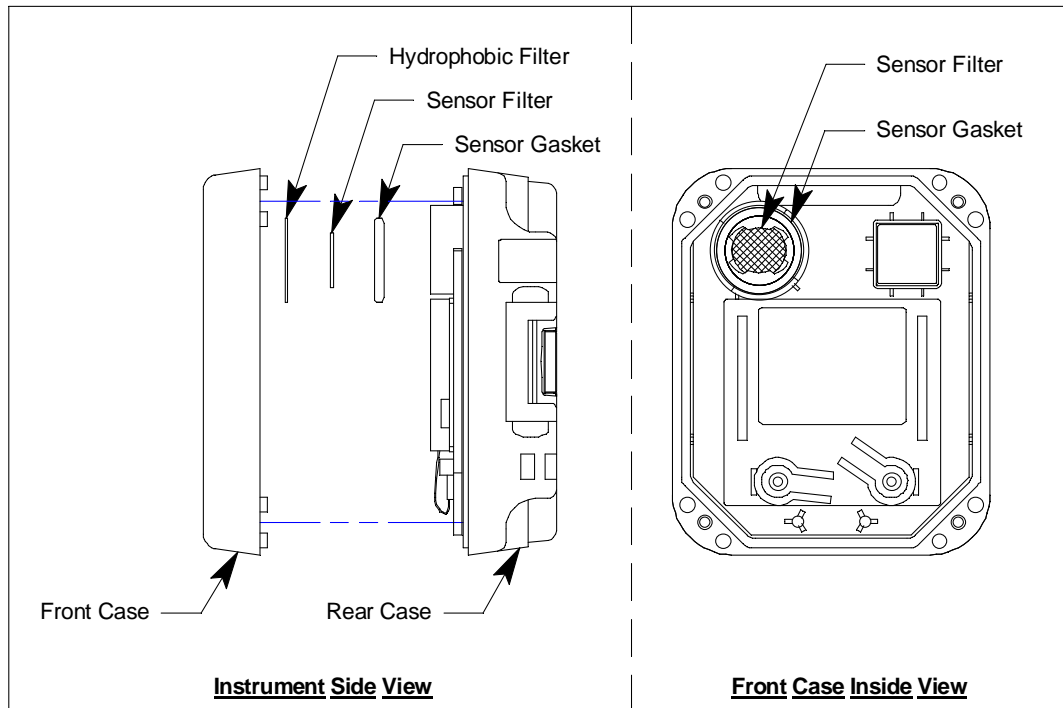

Figure 15: Case Separation

6. Turn the front case upside down.
7. If the sensor stayed in the front case, remove the sensor.
8. Carefully remove the sensor gasket and the sensor filter that sits in the middle of the sensor gasket.

9. Remove the white hydrophobic filter.



10. Install a new hydrophobic filter.
11. Reinstall the sensor gasket with the flat side facing the white hydrophobic filter.
12. If the sensor filter came loose, reinstall it in the middle of the sensor gasket.
13. If necessary, put the sensor in the socket on the rear case. The colored side faces away from the rear case and the slots in the sensor line up with tabs in the socket.

CAUTION: Forcing a sensor into a socket without lining the sensor slots up with the socket tabs may damage the sensor or socket.

14. Reinstall the front case to the rear case.
15. Reinstall the 4 screws that were removed in Step 3.
16. Reinstall the rubber boot, if being used.

Replacing the Sensor

1. Verify that the SC-04 is off.
2. Remove the rubber boot, if installed.
3. Use a small Phillips screwdriver to unscrew the 4 screws that attached the front case to the rear case.

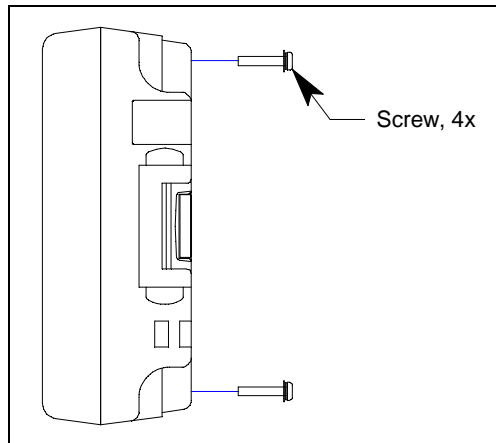

Figure 17: Unscrewing Case

4. Turn the instrument right side up. The screws are not captive and may fall out. Be sure not to lose them.
5. Remove the front case from the rear case.

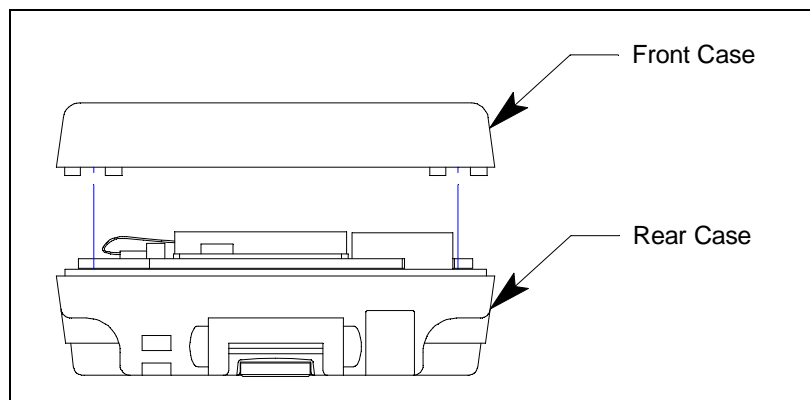

Figure 18: Case Separation

6. Turn the front case upside down.
7. Remove the old sensor. It will either be in its rear case socket or it will be stuck to the sensor gasket in the front case.

8. Install the new sensor in the socket on the rear case. The colored side faces away from the rear case and the slots in the sensor line up with tabs in the socket.

CAUTION: Forcing a sensor into a socket without lining the sensor slots up with the socket tabs may damage the sensor or socket.

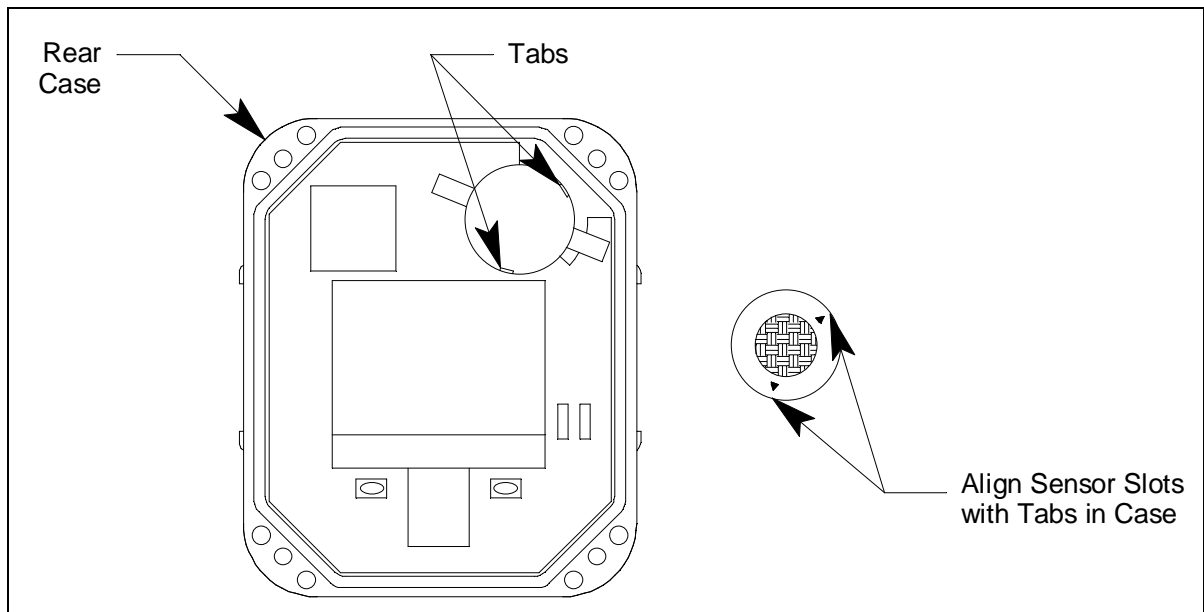

Figure 19: Sensor Location

9. Reinstall the front case to the rear case.
10. Reinstall the 4 screws that were removed in Step 3.
11. Reinstall the rubber boot, if being used.

NOTE: Instruments with newly installed NH₃ sensors require 2 hours for sensor warmup before initial calibration.

12. Calibrate the sensor as described on page 46.

Chapter 7: General Parts List

Table 14 lists part numbers for the SC-04's replacement parts and accessories.

Table 14: General Parts List

Part Number	Description
06-1248RK-03	Calibration kit tubing, 3 foot length
07-6033	Sensor gasket
10-1105-01	Screw, for securing front case to rear case
13-0112RK	Wrist strap
13-0122	Belt clip
13-0128	Alligator clip
13-0204RK	Pins for connecting alligator clip/belt clip
20-0325	Rubber boot
33-0175	Hydrophobic filter
33-7136	Humidity filter disk (white), for PH ₃ sensor, 5 pack
33-7136-01	Humidity filter disk (white), for PH ₃ sensor
33-7138	H ₂ S scrubber disk (dark gray), for HCN sensor, 5 pack
33-7138-01	H ₂ S scrubber disk (dark gray), for HCN sensor
33-7139	H ₂ S scrubber disk (tan), for NO ₂ and SO ₂ sensors, 5 pack
33-7139-01	H ₂ S scrubber disk (tan), for NO ₂ and SO ₂ sensors
33-7141	Humidity filter disk (white), for NH ₃ sensor, 5 pack
33-7141-01	Humidity filter disk (white), for NH ₃ sensor
47-5084RK	USB/IrDA adapter module, Legasic, for use with all premier portables (without USB cable)
47-5084RK-01	USB/IrDA adapter assembly, Legasic, for use with all premier portables (with module and USB cable)
47-5085RK	Cable, USB A to USB mini, 6 feet, for 47-5084RK USB/IrDA adapter module
49-1110RK	AAA size alkaline battery
49-1312	AAA size Ni-MH battery
49-3105RK	4-battery AA/AAA charger with AC adapter and DC vehicle adapter
49-3106RK	12-battery AA/AAA charger with AC adapter

Table 14: General Parts List (Continued)

Part Number	Description
71-0548	Operator's Manual, SC-04 (this document)
71-0525	Operator's Manual, 04 Series Datalogging Program
71-0526	Operator's Manual, 04 Series Setup Program
81-0076RK-01	Calibration cylinder, zero air, 34 liter steel
81-0076RK-03	Calibration cylinder, zero air, 103 liter
81-0170RK-02	Calibration cylinder, 5 ppm SO ₂ in nitrogen, 58 liter
81-0170RK-04	Calibration cylinder, 5 ppm SO ₂ in nitrogen, 34 liter aluminum
81-0176RK-02	Calibration cylinder, 25 ppm NH ₃ in nitrogen, 58 liter
81-0176RK-04	Calibration cylinder, 25 ppm NH ₃ in nitrogen, 34 liter aluminum
81-0180RK-02	Calibration cylinder, 10 ppm NO ₂ in nitrogen, 58 liter
81-0180RK-04	Calibration cylinder, 10 ppm NO ₂ in nitrogen, 34 liter aluminum
81-0186RK-02	Calibration cylinder, 5 ppm PH ₃ in nitrogen, 58 liter
81-0190RK-02	Calibration cylinder, 5 ppm Cl ₂ in nitrogen, 58 liter
81-0190RK-04	Calibration cylinder, 5 ppm Cl ₂ in nitrogen, 34 liter aluminum
81-0196RK-02	Calibration cylinder, 10 ppm HCN in nitrogen, 58 liter
81-0196RK-04	Calibration cylinder, 10 ppm HCN in nitrogen, 34 liter aluminum
81-1050RK-25	Regulator, fixed flow, 0.25 LPM, with gauge and knob, for 17 liter and 34 liter steel cylinders (cylinders with external threads)
81-1051RK-25	Regulator, fixed flow, 0.25 LPM, with gauge and knob, for 34 liter aluminum, 58 liter, and 103 liter cylinders (cylinders with internal threads)
81-1146	Calibration cup
81-SC04CL2-LV	Calibration kit for Cl ₂ SC-04: 34 liter aluminum cylinder of 5 ppm Cl ₂ in N ₂ , regulator, tubing, calibration cup, case
81-SC04HCN-LV	Calibration kit for HCN SC-04: 34 liter aluminum cylinder of 10 ppm HCN in N ₂ , regulator, tubing, calibration cup, case
81-SC04NO2-LV	Calibration kit for NO ₂ SC-04: 34 liter aluminum cylinder of 10 ppm NO ₂ in N ₂ , regulator, tubing, calibration cup, case
81-SC04PH3-LV	Calibration kit for PH ₃ SC-04: 34 liter aluminum cylinder of 0.5 ppm PH ₃ in N ₂ , regulator, tubing, calibration cup, case

Table 14: General Parts List (Continued)

Part Number	Description
81-SC04SO2-LV	Calibration kit for SO ₂ SC-04: 34 liter aluminum cylinder of 5 ppm SO ₂ in N ₂ , regulator, tubing, calibration cup, case
ESR-A13D-HCN	Hydrogen cyanide (HCN) sensor
ESR-A13D-NO2	Nitrogen dioxide (NO ₂) sensor
ESR-A13D-PH3	Phosphine (PH ₃) sensor
ESR-A13D-SO2	Sulfur dioxide (SO ₂) sensor
ESR-B134-NH3	Ammonia (NH ₃) sensor
ESR-B136-CL2	Chlorine (Cl ₂) sensor

Appendix A: Maintenance Mode

Overview

This appendix describes the SC-04 in Maintenance Mode. The SC-04 is factory-set to suit most applications. Update settings in Maintenance Mode only if required for your specific application. Maintenance Mode items and their factory settings are listed in Table 15 below.

Table 15: Maintenance Mode Menu Items

Maintenance Mode Menu Item	Description		
GAS CAL (page 89)	Perform an air adjust, perform a span adjustment, change the calibration values.		
	AIR	Perform a fresh air adjustment.	
	A-CAL or E-CAL depending on E-CAL User Mode setting	Perform a span adjustment and set the calibration gas concentration.	
		A-CAL (or E-CAL)	Perform an automatic span adjustment.
		START	Begin the warmup sequence and enter Measuring Mode.
		CAL-P	Set the calibration gas concentration.
	ESCAPE	Return to the A-CAL item in the GAS CAL menu.	
ESCAPE	Return to the GAS CAL item in Maintenance Mode.		
GAS.TEST (page 89)	Apply gas to test sensor response and observe alarm indications without an alarm event being recorded.		
SEN.DATE (page 91)	View and/or set the replacement date for the sensor and the batteries.		
BUMP (page 91)	Perform a bump test.		
LATCH (page 92)	<p><u>ON (factory setting)</u>: The SC-04 remains in alarm until the alarm condition passes and POWER MODE is pressed.</p> <p><u>OFF</u>: The SC-04 automatically resets an alarm when the alarm condition passes.</p>		
D.ZERO (page 92)	<p><u>ON (factory setting)</u>: You can manually perform a fresh air adjust in Measuring Mode by pressing AIR.</p> <p><u>OFF</u>: You cannot manually perform a fresh air adjust in Measuring Mode by pressing AIR.</p>		

Table 15: Maintenance Mode Menu Items

Maintenance Mode Menu Item	Description
A.ZERO (page 93)	<p><u>ON</u>: The SC-04 asks if you want to perform a fresh air adjustment at the end of the startup sequence.</p> <p><u>OFF (factory setting)</u>: The SC-04 does not ask if you want to perform a fresh air adjustment at the end of the startup sequence.</p>
ID DISP (page 93)	<p><u>ON</u>: User ID and Station ID screens appear in startup sequence. IDs can be changed in Display Mode if DISP.SET in User Mode is also set to ON.</p> <p><u>OFF (factory setting)</u>: User ID and Station ID screens do not appear in startup sequence. IDs cannot be changed in Display Mode.</p>
ZERO.SUP (page 94)	<p><u>ON (factory setting)</u>: Not intended for field adjustment. The suppression values are:</p> <p>Cl₂: 0.10 ppm HCN: 0.5 ppm NH₃: 4 ppm NO₂: 0.30 ppm PH₃: 0.02 ppm SO₂: 0.20 ppm</p>
ZERO.FLW (page 94)	<p><u>ON (factory setting)</u>: Not intended for field adjustment.</p>
ZSUP.DSP (page 94)	<p><u>ON</u>: Zero suppression item appears in User Mode.</p> <p><u>OFF (factory setting)</u>: Zero suppression item does not appear in User Mode. (Zero suppression item is always available in Maintenance Mode)</p>
ZFLW.DSP (page 94)	<p><u>ON</u>: Zero follower item appears in User Mode.</p> <p><u>OFF (factory setting)</u>: Zero follower item does not appear in User Mode. (Zero follower item is always available in Maintenance Mode)</p>
CYL.DISP (page 95)	<p><u>ON</u>: CYL SEL item appears in GAS CAL.</p> <p><u>OFF (factory setting)</u>: CYL SEL item does not appear in GAS CAL. (RKI Instruments, Inc. does not recommend adjusting this setting.)</p>
DATE (page 95)	<p>Set the current date and time.</p>
PASS-W (page 95)	<p><u>ON (factory setting)</u>: Maintenance Mode is password-protected. Factory-set password is 0400.</p> <p><u>OFF</u>: Maintenance Mode is not password-protected.</p>
ROM/SUM (page 96)	<p>View the firmware information for the SC-04's sensor board and main board.</p>
M.DEF (page 97)	<p>Set all parameters back to their RKI factory settings.</p>

Table 15: Maintenance Mode Menu Items

Maintenance Mode Menu Item	Description
START (page 97)	Press and release POWER MODE to begin the warmup sequence and enter Measuring Mode.

Entering Maintenance Mode

WARNING: *The SC-04 is not in operation as a gas detector while in Maintenance Mode.*

1. Take the SC-04 to a non-hazardous location and turn it off if it is on.
2. Press and hold AIR, then press and hold POWER MODE. You will hear a beep after one second. Continue to hold the buttons down.
3. When you hear a second beep, release the buttons.
4. The screen that appears depends on the setting of Maintenance Mode's **PASS-W** item.
If **PASS-W** is set to **OFF**, continue with Step 8.
If **PASS-W** is set to **ON** (factory setting), continue with Step 5.

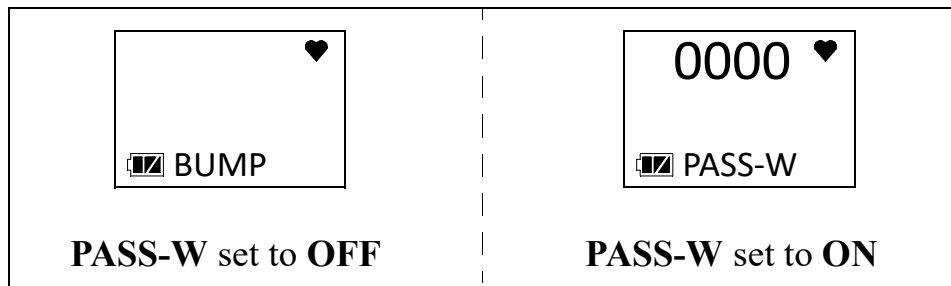

5. If **PASS-W** is set to **ON** in Maintenance Mode, a password screen appears and the first digit is flashing. The factory-set password is **0400** but it can be changed.
6. Use AIR to select each password number then press POWER MODE to save it and move on to the next number. To go back a number, press and hold AIR and POWER MODE for a few seconds. To reverse the direction of change (ie. from increasing to decreasing or vice versa):
 - a. Press and hold AIR.
 - b. Immediately press POWER MODE and then release both buttons.
7. Continue to Step 6.
8. The **GAS CAL** item displays.

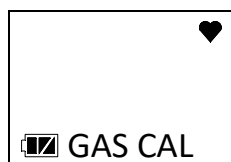

9. Use AIR to move through the Maintenance Mode items.

Tips for Using Maintenance Mode

- To scroll from one item to the next, press and release AIR. To reverse the scrolling direction:
 - a. Press and hold AIR.
 - b. Immediately press POWER MODE and then release both buttons.
 - c. The scrolling direction returns to the original direction when you exit and reenter a menu.
- To skip an item when a question is asked, press and release AIR.
- To enter an item and to save any changes, press and release POWER MODE.
- To change a flashing parameter, press and release AIR. To reverse the direction of change (ie. from increasing to decreasing or vice versa):
 - a. Press and hold AIR.
 - b. Immediately press POWER MODE and then release both buttons.
- To exit an entered item without saving a change, press and hold AIR and POWER MODE for a few seconds.

Performing a Calibration (GAS CAL)

See page 46 for a description of the GAS CAL item.

Performing a Gas Test (GAS.TEST)

The GAS.TEST item allows you to apply gas to the instrument and see all alarm indications except for the buzzer indication. There is no buzzer indication in the GAS.TEST menu even though the buzzer sounds in the event of a real gas alarm condition while in Measuring Mode.

A gas test is not saved in logged data.

Preparing for a Gas Test

To perform a gas test on the SC-04, you need:

- A calibration gas cylinder. The concentrations should be above the alarm condition you want to check. Standard alarm points are listed on page 8.
- A 0.25 LPM fixed flow regulator
- Non-absorbent tubing
- Calibration cup

1. Install the calibration cup onto the SC-04. Be sure the calibration cup is installed in the correct direction and that it is pushed on all the way.

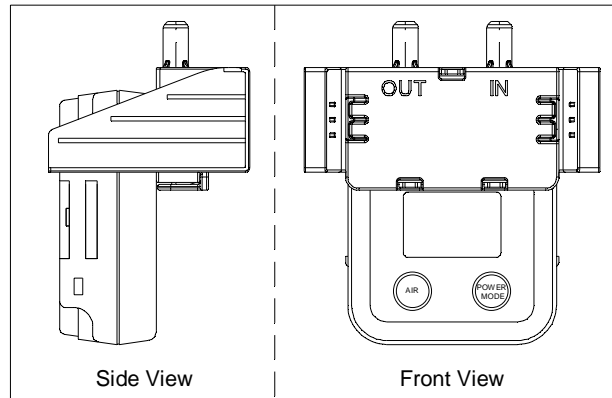

2. Use the tubing to connect the regulator to the inlet of the calibration cup (labeled “IN”).

Performing a Gas Test

1. While in Maintenance Mode, press AIR to scroll to **GAS.TEST**.



2. Press and release POWER MODE. The current gas reading displays. The bottom of the LCD alternates between “GAS.TEST” and “BUZZ.OFF”.

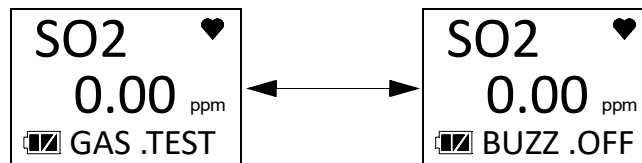

3. For toxic gas cylinders, it is important to vent the regulator while installing it onto the cylinder. Venting the regulator during installation helps prevent air from getting into the cylinder and degrading the gas. Open the regulator by turning the knob counterclockwise and install it onto the cylinder.
4. The instrument initiates alarm indications except for the buzzer. There is no buzzer indication in the **GAS.TEST** menu even though the buzzer sounds in the event of a real gas alarm condition.
5. Turn the regulator knob clockwise to close the regulator.
6. Unscrew the regulator from the calibration cylinder.
7. Remove the calibration cup from the SC-04.

8. Store the calibration kit in a safe and convenient place.
9. Press and release POWER MODE to return to the **GAS.TEST** item in Maintenance Mode.
10. See “Entering Measuring Mode (START)” on page 97 to enter Measuring Mode.

Sensor/Battery Replacement Date (SEN.DATE)

The **SEN.DATE** item allows you to keep track of when the sensor and the batteries were replaced.

1. While in Maintenance Mode, press AIR to scroll to **SEN.DATE**.

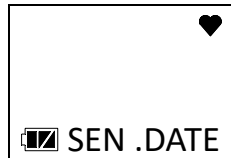

2. Press and release POWER MODE. The sensor replacement date displays.
3. Use AIR to scroll to the item whose replacement date you want to view or change.

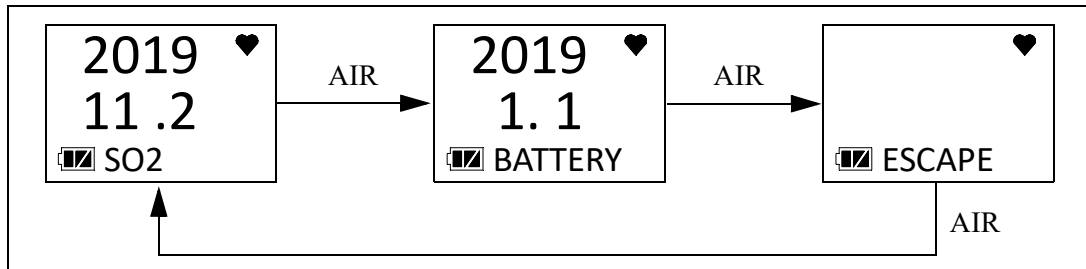

4. To change the replacement date:
 - a. With the desired item displayed, press and release POWER MODE.
 - b. Press and release POWER MODE again to set the replacement date to the current date.
5. Use the AIR button to scroll to **ESCAPE**.
6. Press and release POWER MODE to return to the **SEN.DATE** item in Maintenance Mode.
7. See “Entering Measuring Mode (START)” on page 97 to enter Measuring Mode.

Performing a Bump Test (BUMP)

See “Performing a Bump Test (BUMP)” on page 42 for a description of the **BUMP** item.

Setting Alarms to Latching or Self-Resetting (LATCH)

ON (factory setting): The SC-04 remains in alarm until the alarm condition passes *and* POWER MODE is pressed.

OFF: The SC-04 automatically resets an alarm when the alarm condition passes.

1. While in Maintenance Mode, press AIR to scroll to **LATCH**.



2. Press and release POWER MODE. The current setting flashes.
3. Use AIR to display the desired setting.
4. Press and release POWER MODE to save the setting and return to the **LATCH** item in Maintenance Mode.
5. See “Entering Measuring Mode (START)” on page 97 to enter Measuring Mode.

Turning the Demand Zero Function On/Off (D.ZERO)

ON (factory setting): You can manually perform a fresh air adjust in Measuring Mode by pressing AIR.

OFF: You cannot manually perform a fresh air adjust in Measuring Mode.

1. While in Maintenance Mode, press AIR to scroll to **D.ZERO**.

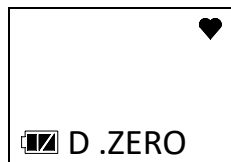

2. Press and release POWER MODE. The current setting flashes.
3. Use AIR to display the desired setting.
4. Press and release POWER MODE to save the setting and return to the **D.ZERO** item in Maintenance Mode.
5. See “Entering Measuring Mode (START)” on page 97 to enter Measuring Mode.

Turning the Auto Zero Function On/Off (A.ZERO)

ON: The SC-04 asks if you want to perform a fresh air adjustment at the end of the startup sequence.

OFF (factory setting): The SC-04 does not ask if you want to perform a fresh air adjustment at the end of the startup sequence.

1. While in Maintenance Mode, press AIR to scroll to **A.ZERO**.

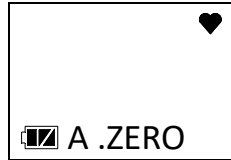

2. Press and release POWER MODE. The current setting flashes.
3. Use AIR to display the desired setting.
4. Press and release POWER MODE to save the setting and return to the **A.ZERO** item in Maintenance Mode.
5. See “Entering Measuring Mode (START)” on page 97 to enter Measuring Mode.

Turning the ID Display Function On/Off (ID DISP)

ON: The User ID and Station ID screens appear in the startup sequence. If **DISP.SET** in User Mode is also set to **ON**, then the IDs can be changed in Display Mode.

OFF (factory setting): The User ID and Station ID screens do not appear in the startup sequence and the IDs cannot be changed in Display Mode.

1. While in Maintenance Mode, press AIR to scroll to **ID DISP**.



2. Press and release POWER MODE. The current setting flashes.
3. Use AIR to display the desired setting.
4. Press and release POWER MODE to save the setting and return to the **ID DISP** item in Maintenance Mode.
5. See “Entering Measuring Mode (START)” on page 97 to enter Measuring Mode.

Turning the Zero Suppression On/Off (ZERO.SUP)

The ZERO.SUP setting is not intended for field adjustment. The default setting is ON.

Sensor	Zero Suppression Value
Cl ₂	0.10 ppm
HCN	0.5 ppm
NH ₃	4 ppm
NO ₂	0.30 ppm
PH ₃	0.02 ppm
SO ₂	0.20 ppm

Turning the Zero Follower On/Off (ZERO.FLW)

The ZERO.FLW setting is not intended for field adjustment. The default setting is ON.

User Mode Zero Suppression (ZSUP.DSP)

ON: Zero suppression item appears in User Mode.

OFF (factory setting): Zero suppression item does not appear in User Mode. The zero suppression item is always available in Maintenance Mode.

It is not normally necessary to have the zero suppression item appear in User Mode. Contact RKI Instruments before turning this setting on.

User Mode Zero Follower (ZFLW.DSP)

ON: Zero follower item appears in User Mode.

OFF (factory setting): Zero follower item does not appear in User Mode. The zero follower item is always available in Maintenance Mode.

It is not normally necessary to have the zero follower item appear in User Mode. Contact RKI Instruments before turning this setting on.

Cylinder Setting (CYL.DISP)

ON: CYL SEL item appears in User and Maintenance Modes' GAS CAL item.

OFF (factory setting): CYL SEL item does not appear in User and Maintenance Modes' GAS CAL item.

Setting the Date/Time (DATE)

1. From the main menu, place the cursor next to **DATE**.



2. Press and release POWER MODE. The date and time display with the year flashing.

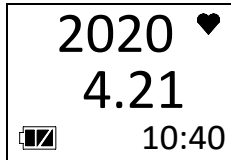

3. Use AIR to display the desired year.
4. Press and release POWER MODE to save the setting. The month setting flashes.
5. Repeat Step 3 and Step 4 to enter the month, day, hours, and minutes settings. The date and time are saved and the instrument returns to the **DATE** item in Maintenance Mode.
6. See “Entering Measuring Mode (START)” on page 97 to enter Measuring Mode.

Turning the Password On/Off (PASS-W)

ON (factory setting): The SC-04 prompts you for a password when you enter Maintenance Mode. The factory-set password is **0400** but it can be changed.

OFF: No password is required to enter Maintenance Mode.

1. While in Maintenance Mode, press AIR to scroll to **PASS-W**.

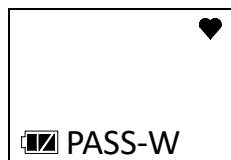

2. Press and release POWER MODE. The current setting flashes.
3. Use AIR to display the desired setting.

4. If you selected **OFF**, press and release POWER MODE to save the setting and return to the **PASS-W** item in User Mode.
If you selected **ON**, continue with Step 5.
5. Press and release POWER MODE. The Set Password Screen appears. The current password displays and the first digit flashes.

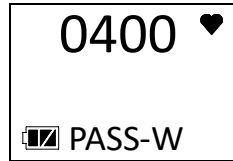

6. Use AIR to display a number from 0 to 9.
7. Press and release POWER MODE to enter the selection and advance to the next number. To go back a number, press and hold AIR and POWER MODE for a few seconds.
8. Repeat Step 6 and Step 7 to select the remaining numbers. When you press and release POWER MODE to enter the last number, the password is saved and the instrument returns to the **PASSWORD** item in Maintenance Mode.
9. See “Entering Measuring Mode (START)” on page 97 to enter Measuring Mode.

Viewing the ROM/SUM (ROM/SUM)

The **ROM/SUM** screen shows the instrument’s firmware version and firmware checksum.

1. While in Maintenance Mode, press AIR to scroll to **ROM/SUM**.



2. Press and release POWER MODE. The screen shows the ROM/SUM. The ROM is the top value and the SUM is the bottom value.

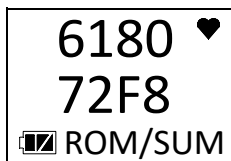

3. Press and release POWER MODE to return to the **ROM/SUM** item in Maintenance Mode.
4. See “Entering Measuring Mode (START)” on page 97 to enter Measuring Mode.

Performing a Default (M.DEF)

Performing a default operation in Maintenance Mode returns all parameters to their RKI factory settings.

1. While in Maintenance Mode, press AIR to scroll to **M.DEF**.



2. Press and release POWER MODE.

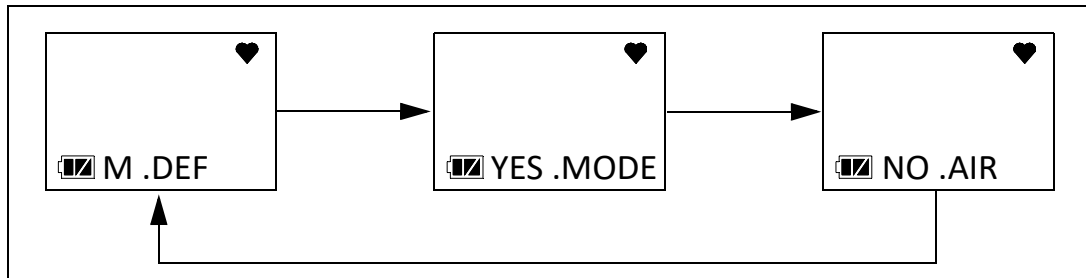

3. Press and release POWER MODE to perform a default operation. The instrument asks if you are sure you want to perform a default operation.

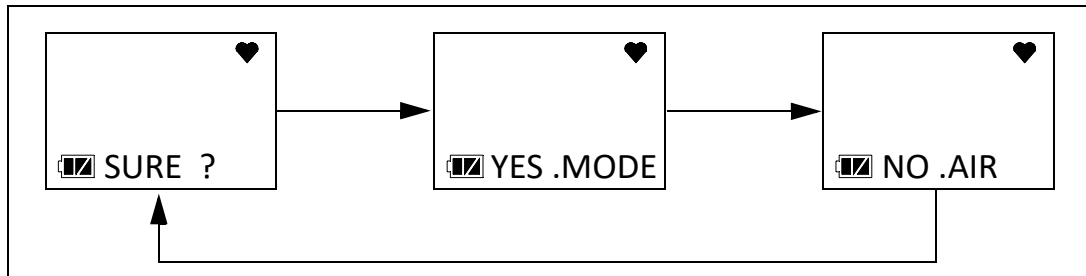

4. Press and release POWER MODE to perform a default operation. The instrument beeps twice and returns to the **M.DEF** item in Maintenance Mode.
5. See “Entering Measuring Mode (START)” on page 97 to enter Measuring Mode.

Entering Measuring Mode (START)

1. While in Maintenance Mode, press AIR to scroll to **START**.



2. Press and release POWER MODE. The instrument begins its warmup sequence.

Appendix B: Gas Select Mode

Overview

This appendix describes the SC-04 in Gas Select Mode. The SC-04 is factory-set to suit most applications. Update settings in Gas Select Mode only if required for your specific application. A description of the Gas Select Mode items is shown in Table 16 below.

Table 16: Gas Select Mode Menu Items

Menu Item (Page # of Description)	Description
SAVE-AP (page 99)	Set the current alarm points as the default alarm points.
MAX.SPAN (page 100)	<u>ON</u> : Maximum span screen appears after a successful calibration. <u>OFF (factory setting)</u> : No maximum span screen appears.
STEALTH (page 101)	<u>STEALTH ON</u> : No backlight, LED, or buzzer operation. <u>STEALTH OFF (factory setting)</u> : Backlight, LED, and buzzer operate normally.
	This setting has no effect unless STEALTH is set to ON. <u>VIB ON</u> : Vibrator activates for alarm conditions. <u>VIB OFF (factory setting)</u> : Vibrator does not activate in any situation.
START (page 101)	Enter Measuring Mode

Entering Gas Select Mode

WARNING: The SC-04 is not in operation as a gas detector while in Gas Select Mode.

1. Take the SC-04 to a non-hazardous location and turn it off if it is on.
2. Press and hold AIR, then press and hold POWER MODE. You will hear a beep after one second. Continue to hold the buttons down.
3. You will hear a second beep. Continue to hold the buttons down.
4. When you hear a third beep, release the buttons.
5. A password screen appears and the first digit flashes. The password is **2014**.

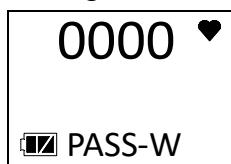

- Use AIR to select each password number then press POWER MODE to save it and move on to the next number. To go back a number, press and hold AIR and POWER MODE for a few seconds.
- The **SAVE-AP** item displays.



- Use AIR to move through the Gas Select Mode items.

Tips for Using Gas Select Mode

- To scroll from one item to the next, press and release AIR. To reverse the scrolling direction:
 - Press and hold AIR.
 - Immediately press POWER MODE and then release both buttons.
 - The scrolling direction returns to the original direction when you exit and reenter a menu.
- To skip an item when a question is asked, press and release AIR.
- To enter an item and to save any changes, press and release POWER MODE.
- To change a flashing parameter, press and release AIR. To reverse the direction of change (ie. from increasing to decreasing or vice versa):
 - Press and hold AIR.
 - Immediately press POWER MODE and then release both buttons.
- To exit an entered item without saving a change, press and hold AIR and POWER MODE for a few seconds.

Saving the Alarm Points (SAVE-AP)

Performing a **SAVE-AP** operation saves the current alarm setpoints.

Performing a **DEF.ALMP** operation in the **ALARM-P** User Mode menu sets the instrument's alarm points to those saved during the **SAVE-AP** operation (if performed).

Performing a **SAVE-AP** has no effect on an **M.DEF** in Maintenance Mode. An **M.DEF** operation returns all instrument settings to the RKI default regardless of if a **SAVE-AP** operation was performed.

- While in Gas Select Mode, press AIR to scroll to **SAVE-AP**.



2. Press and release POWER MODE. The display cycles through the following screens.

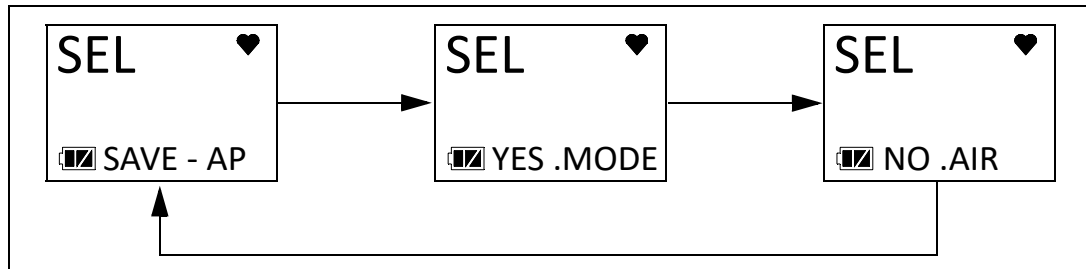

3. Press and release POWER MODE to save the current alarm point settings as the default.
4. The instrument returns to the **SAVE-AP** item in Gas Select Mode.
5. See “Exiting Gas Select Mode (START)” on page 101 to enter Measuring Mode.

Turning Calibration Max Span On/Off (MAX.SPAN)

ON: After a passed calibration, the SC-04 displays the response reading’s maximum adjustment. A maximum span of 100 ppm indicates that the reading could have been adjusted up to 100 ppm. If the maximum span value is close to the calibration value, the sensor should be replaced soon. The upper limit on the maximum adjustment indicated is either twice the calibration value or full scale, whichever is lower.

OFF (factory setting): There is no maximum span indication at the end of a calibration.

1. While in Gas Select Mode, press AIR to scroll to **MAX.SPAN**.



2. Press and release POWER MODE. The current setting flashes.
3. Use AIR to display the desired setting.
4. Press and release POWER MODE to save the setting and return to the **MAX.SPAN** item in Gas Select Mode.
5. See “Exiting Gas Select Mode (START)” on page 101 to enter Measuring Mode.

Stealth and Vibrator Settings (STEALTH)

STEALTH

ON:

- The instrument's backlight does not come on, regardless of the **BL TIME** setting.
- The instrument's LED does not come on for any reason, even alarm conditions.
- The instrument's buzzer does not sound for any reason, even alarm conditions.
- An "S" appears at the bottom of the LCD.

OFF (factory setting): The instrument's backlight, LED, and buzzer operate normally.

VIB

The **VIB** setting only affects instrument operation if **STEALTH** is set to **ON**.

ON: The vibrator activates for alarm conditions. It can be useful to have this feature turned on if you have also turned **STEALTH** on.

OFF (factory setting): The vibrator does not activate for any reason.

1. While in Gas Select Mode, press AIR to scroll to **STEALTH**.



2. Press and release POWER MODE. The current **STEALTH** setting flashes.
3. Use AIR to display the desired setting.
4. Press and release POWER MODE. The current **VIB** setting flashes.
5. Use AIR to display the desired setting.
6. Press and release POWER MODE to save the setting and return to the **STEALTH** item in Gas Select Mode.
7. See "Exiting Gas Select Mode (START)" on page 101 to enter Measuring Mode.

Exiting Gas Select Mode (START)

1. While in Gas Select Mode, press AIR to scroll to **START**.



2. Press and release POWER MODE. The instrument begins its warm-up sequence.

Appendix C: Interference Information

ESR-A13D-HCN, HCN Detection

Gas	Chemical Formula	Concentration	Indication Value
Acetone	C ₃ H ₆ O	5000 ppm	1.0 ppm
Acetylene	C ₂ H ₂	5 ppm	11.2 ppm
Ammonia	NH ₃	38.6 ppm	0.2 ppm
Carbon Dioxide	CO ₂	20.0 vol%	0.2 ppm
Carbon Monoxide	CO	100 ppm	0.3 ppm
Chlorine	Cl ₂	0.2 ppm	0.2 ppm
Ethane	C ₂ H ₆	1.6 vol%	0.0 ppm
Ethanol	C ₂ H ₅ OH	8333 ppm	-0.8 ppm ^{*1}
Hydrogen	H ₂	500 ppm	1.1 ppm
Hydrogen Sulfide	H ₂ S	25.0 ppm	0.2 ppm
Isobutane	i-C ₄ H ₁₀	0.72 vol%	12.3 ppm
Isopropyl Alcohol	C ₃ H ₈ O	5000 ppm	1.8 ppm ^{*1}
Methane	CH ₄	5.0 vol%	0.0 ppm
Methyl Ethyl Ketone	C ₄ H ₈ O	5000 ppm	0.6 ppm
Methyl Methacrylate	C ₅ H ₈ O ₂	4250 ppm	0.3 ppm
n-Hexane	n-C ₆ H ₁₄	3000 ppm	0.0 ppm
Nitrogen Dioxide	NO ₂	6.1 ppm	-28.9 ppm ^{*1}
Nitrogen Monoxide	NO	5.0 ppm	-12.7 ppm ^{*1}
Ozone	O ₃	0.45 ppm	-0.2 ppm
Phosphine	PH ₃	0.48 ppm	4.0 ppm
Propane	C ₃ H ₈	0.88 vol%	0.1 ppm
Propylene	C ₃ H ₆	0.7 vol%	34.6 ppm
Sulfur Dioxide	SO ₂	30.0 ppm	0.2 ppm
*1 The indicated value may fluctuate when exposed to this gas.			

ESR-A13D-NO2, NO₂ Detection

Gas	Chemical Formula	Concentration	Indication Value
Acetone	C ₃ H ₆ O	0.54 vol%	-0.24 ppm
Acetylene	C ₂ H ₂	100 ppm	-0.19 ppm
Ammonia	NH ₃	38.6 ppm	-0.02 ppm
Benzene	C ₆ H ₆	0.30 vol%	-0.73 ppm ^{*1}
Carbon Dioxide	CO ₂	20.0 vol%	-0.02 ppm
Carbon Monoxide	CO	99.9 ppm	-0.54 ppm
Chlorine	Cl ₂	2.0 ppm	-0.20 ppm
Cyclopentane	C ₅ H ₁₀	0.35 vol%	-0.03 ppm
Ethane	C ₂ H ₆	0.75 vol%	-0.02 ppm
Ethanol	C ₂ H ₅ OH	8333 ppm	-0.22 ppm ^{*1}
Ethyl Acetate	C ₄ H ₈ O ₂	0.53 vol%	-0.11 ppm
Fluorine	F ₂	1.6 ppm	-0.04 ppm
Hydrogen	H ₂	500 ppm	-0.80 ppm
Hydrogen Bromide	HBr	9.0 ppm	-0.04 ppm
Hydrogen Chloride	HCl	3.2 ppm	-0.06 ppm
Hydrogen Sulfide	H ₂ S	25.0 ppm	-0.09 ppm
Isobutane	i-C ₄ H ₁₀	0.45 vol%	-0.05 ppm
Isobuten	C ₄ H ₈	1000 ppm	-27.14 ppm
Isopropyl Alcohol	C ₃ H ₈ O	0.50 vol%	-0.63 ppm
Methane	CH ₄	1.26 vol%	-0.09 ppm
Methanol	CH ₃ OH	1.38 vol%	-2.32 ppm ^{*1}
Methyl Ethyl Ketone	C ₄ H ₈ O	0.45 vol%	-1.09 ppm
Methyl Isobutyl Ketone	C ₆ H ₁₂ O	0.30 vol%	-0.20 ppm
Methyl Methacrylate	C ₅ H ₈ O ₂	4250 ppm	-0.13 ppm
n-Hexane	n-C ₆ H ₁₄	0.30 vol%	-0.02 ppm

Gas	Chemical Formula	Concentration	Indication Value
Nitrogen Monoxide	NO	99.2 ppm	-3.12 ppm
Nonane	n-C ₉ H ₂₀	0.18 vol%	-0.01 ppm
Ozone	O ₃	0.48 ppm	0.30 ppm
Phosphine	PH ₃	2.51 ppm	-0.02 ppm
Propane	C ₃ H ₈	0.49 vol%	-0.01 ppm
Propylene	C ₃ H ₆	0.5 vol%	-48.27 ppm
Sulfur Dioxide	SO ₂	5 ppm	-4.99 ppm
Tetrahydrofuran	C ₄ H ₈ O	0.50 vol%	-0.90 ppm ^{*1}
Toluene	C ₇ H ₈	1.0 vol%	-0.46 ppm ^{*1}
Xylene	C ₈ H ₁₀	1.0 vol%	-0.12 ppm ^{*1}
*1 The indicated value may fluctuate when exposed to this gas.			

ESR-A13D-PH3, PH₃ Detection

Gas	Chemical Formula	Concentration	Indication Value
Acetone	C ₃ H ₆ O	0.54 vol%	0.01 ppm
Acetylene	C ₂ H ₂	99.7 ppm	20.01 ppm
Ammonia	NH ₃	40.9 ppm	0.00 ppm
Arsine	AsH ₃	1.07 ppm	0.80 ppm
Bromomethane	CH ₃ Br	150 ppm	0.01 ppm
Carbon Dioxide	CO ₂	20.0 vol%	0.00 ppm
Carbon Monoxide	CO	100 ppm	0.03 ppm
Diborane	B ₂ H ₆	5.1 ppm	1.14 ppm
Disilane	Si ₂ H ₆	7.2 ppm	6.54 ppm
Ethanol	C ₂ H ₅ OH	8333 ppm	0.00 ppm
Ethyl Acetate	C ₄ H ₈ O ₂	0.53 vol%	0.01 ppm
Hydrogen	H ₂	500 ppm	0.05 ppm
Hydrogen Chloride	HCl	8.0 ppm	0.00 ppm
Hydrogen Cyanide	HCN	5.0 ppm	0.39 ppm
Hydrogen Selenide	H ₂ Se	10 ppm	4.45 ppm
Hydrogen Sulfide	H ₂ S	25.0 ppm	10.60 ppm
Isopropyl Alcohol	C ₃ H ₈ O	0.50 vol%	0.02 ppm
Methane	CH ₄	2.56 vol%	0.00 ppm
Methanol	CH ₃ OH	1.38 vol%	0.00 ppm
Nitrogen Dioxide	NO ₂	5.0 ppm	-1.28 ppm
Nitrogen Monoxide	NO	100 ppm	-0.44 ppm
Propylene	C ₃ H ₆	0.5 vol%	1.99 ppm
Silane	SiH ₄	7.2 ppm	4.08 ppm
Sulphur Dioxide	SO ₂	8.0 ppm	0.00 ppm
Toluene	C ₇ H ₈	1.0 vol%	-2.01 ppm

Gas	Chemical Formula	Concentration	Indication Value
Xylene	C ₈ H ₁₀	1.0 vol%	-1.04 ppm

ESR-A13D-SO₂, SO₂ Detection

Table 17: Interference Chart for ESR-A13D-SO₂, SO₂ Detection

Gas	Chemical Formula	Concentration	Indication Value
Acetone	C ₃ H ₆ O	0.54 vol%	0.24 ppm
Acetylene	C ₂ H ₂	100 ppm	0.19 ppm
Ammonia	NH ₃	38.6 ppm	0.02 ppm
Benzene	C ₆ H ₆	0.30 vol%	0.73 ppm ^{*1}
Carbon Dioxide	CO ₂	20.0 vol%	0.02 ppm
Carbon Monoxide	CO	99.9ppm	0.54 ppm
Chlorine	Cl ₂	2.0 ppm	0.20 ppm
Cyclopentane	C ₅ H ₁₀	0.35 vol%	0.03 ppm
Ethane	C ₂ H ₆	0.75 vol%	0.02 ppm
Ethanol	C ₂ H ₅ OH	8333 ppm	0.22 ppm ^{*1}
Ethyl Acetate	C ₄ H ₈ O ₂	0.53 vol%	0.11 ppm
Fluorine	F ₂	1.6 ppm	0.04 ppm
Hydrogen	H ₂	500 ppm	0.80 ppm
Hydrogen Bromide	HBr	9.0 ppm	0.04 ppm
Hydrogen Chloride	HCl	3.2 ppm	0.06 ppm
Hydrogen Sulfide	H ₂ S	25.0 ppm	0.09 ppm
Isobutane	i-C ₄ H ₁₀	0.45 vol%	0.05 ppm
Isobuten	C ₄ H ₈	1000 ppm	27.19 ppm
Isopropyl Alcohol	C ₃ H ₈ O	0.50 vol%	0.63 ppm
Methane	CH ₄	1.26 vol%	0.09 ppm
Methanol	CH ₃ OH	1.38 vol%	2.32 ppm ^{*1}
Methyl Ethyl Ketone	C ₄ H ₈ O	0.45 vol%	1.09 ppm
Methyl Isobutyl Ketone	C ₆ H ₁₂ O	0.30 vol%	0.20 ppm
Methyl Methacrylate	C ₅ H ₈ O ₂	4250 ppm	0.13 ppm

Table 17: Interference Chart for ESR-A13D-SO₂, SO₂ Detection

Gas	Chemical Formula	Concentration	Indication Value
n-Hexane	n-C ₆ H ₁₄	0.30 vol%	0.02 ppm
Nitrogen Dioxide	NO ₂	5.0 ppm	-5.01 ppm
Nitrogen Monoxide	NO	99.2 ppm	3.13 ppm
Nonane	n-C ₉ H ₂₀	0.18 vol%	0.01 ppm
Ozone	O ₃	0.48 ppm	-0.30 ppm
Phosphine	PH ₃	2.51 ppm	0.02 ppm
Propane	C ₃ H ₈	0.49 vol%	0.01 ppm
Propylene	C ₃ H ₆	0.5 vol%	48.27 ppm
Tetrahydrofuran	C ₄ H ₈ O	0.50 vol%	0.90 ppm ^{*1}
Toluene	C ₇ H ₈	1.0 vol%	0.46 ppm ^{*1}
Xylene	C ₈ H ₁₀	1.0 vol%	0.12 ppm ^{*1}
^{*1} The indicated value may fluctuate when exposed to this gas.			

ESR-B134-NH3, NH₃ Detection

Table 18: Interference Chart for ESR-B134-NH3, NH₃ Detection

Gas	Chemical Formula	Concentration	Indication Value
Carbon Dioxide	CO ₂	1 vol%	0.3 ppm
Carbon Monoxide	CO	50 ppm	0.7 ppm
Chlorine	Cl ₂	0.8 ppm	1.1 ppm
Ethanol	C ₂ H ₅ OH	0.83 vol%	5.4 ppm
Hydrogen	H ₂	500 ppm	0.7 ppm
Hydrogen Chloride	HCl	8 ppm	0.5 ppm
Hydrogen Cyanide	HCN	8.0 ppm	2.5 ppm
Hydrogen Sulfide	H ₂ S	30 ppm	0.6 ppm
Isobutane	C ₄ H ₁₀	0.89 vol%	0.9 ppm
Methane	CH ₄	2.21 vol%	1.0 ppm
Nitric Oxide	NO	101 ppm	0.8 ppm
Nitrogen Dioxide	NO ₂	99 ppm	-23.9 ppm
Oxygen	O ₂	100 vol%	0.4 ppm
Ozone	O ₃	0.3 ppm	8.5 ppm
Phosphine	PH ₃	0.5 ppm	1.0 ppm
Sulfur Dioxide	SO ₂	30 ppm	1.0 ppm

ESR-B136-CL2, Cl₂ Detection

Table 19: Interference Chart for ESR-B136-Cl₂, Cl₂ Detection

Gas	Chemical Formula	Concentration	Indication Value
Acetone	CH ₃ COCH ₃	1 vol%	0 ppm
Ammonia	NH ₃	40 ppm	-0.22 ppm
Carbon Dioxide	CO ₂	5 vol%	0.39 ppm
Carbon Monoxide	CO	2970 ppm	-0.05 ppm
Ethanol	C ₂ H ₅ OH	1 vol%	0 ppm
Fluorine	F ₂	1.6 ppm	0.43 ppm
Hydrogen	H ₂	1.99 vol%	-0.07 ppm
Hydrogen Bromide	HBr	3.2 ppm	0.04 ppm
Hydrogen Chloride	HCl	5 ppm	0.29 ppm
Hydrogen Sulfide	H ₂ S	30 ppm	-0.69 ppm
Isopropyl Alcohol	CH ₃ CH(OH)CH ₃	1 vol%	0 ppm
Methane	CH ₄	99.9 vol%	-0.04 ppm
Nitric Oxide	NO	101 ppm	-0.04 ppm
Nitrogen Dioxide	NO ₂	49.9 ppm	0.57 ppm
Ozone	O ₃	0.533 ppm	0.07 ppm
Phosphine	PH ₃	2.52 ppm	-0.06 ppm
Sulfur Dioxide	SO ₂	5 ppm	0.09 ppm

Warranty

RKI Instruments, Inc. warrants the SC-04 instrument sold by us to be free from defects in materials, workmanship, and performance for a period of three years from the date of shipment from RKI Instruments, Inc. Original Cl₂ and NH₃ sensors are warranted for 1 year, and all other original sensors are warranted for 3 years. Replacement parts (except sensors) are warranted for 1 year from the date of their shipment from RKI Instruments, Inc. Replacement Cl₂ and NH₃ sensors are warranted for 1 year, and all other replacement sensors are warranted for 3 years. Any parts found defective within their warranty period will be repaired or replaced, at our option, free of charge. This warranty does not apply to those items which by their nature are subject to deterioration or consumption in normal service, and which must be cleaned, repaired, or replaced on a routine basis. Examples of such items are:

- Absorbent cartridges
- Filter elements, disks, or sheets
- Pump diaphragms and valves

Warranty is voided by abuse including mechanical damage, alteration, rough handling, or repair procedures not in accordance with the instruction manual. This warranty indicates the full extent of our liability, and we are not responsible for removal or replacement costs, local repair costs, transportation costs, or contingent expenses incurred without our prior approval.

THIS WARRANTY IS EXPRESSLY IN LIEU OF ANY AND ALL OTHER WARRANTIES AND REPRESENTATIONS, EXPRESSED OR IMPLIED, AND ALL OTHER OBLIGATIONS OR LIABILITIES ON THE PART OF RKI INSTRUMENTS, INC. INCLUDING BUT NOT LIMITED TO THE WARRANTY OF MERCHANTABILITY OR FITNESS FOR A PARTICULAR PURPOSE. IN NO EVENT SHALL RKI INSTRUMENTS, INC. BE LIABLE FOR INDIRECT, INCIDENTAL, OR CONSEQUENTIAL LOSS OR DAMAGE OF ANY KIND CONNECTED WITH THE USE OF ITS PRODUCTS OR FAILURE OF ITS PRODUCTS TO FUNCTION OR OPERATE PROPERLY.

This warranty covers instruments and parts sold to users only by authorized distributors, dealers, and representatives as appointed by RKI Instruments, Inc.

We do not assume indemnification for any accident or damage caused by the operation of this gas monitor and our warranty is limited to replacement of parts or our complete goods.