

FLUKE®

80K-15

Electronic Air Cleaner Probe

Instructions

The 80K-15 Electronic Air Cleaner Probe (the probe or Product) is a low energy probe that is able to extend the voltage measuring capability of an ac/dc voltmeter or multimeter.

Properly connected, the probe is rated to 15 kV dc or 10 kV ac rms. The use of the probe is restricted to low-energy applications that are energy-limited circuits such as electrostatic air cleaners.

The probe is a precision 1000:1 voltage divider formed by two matched resistors. The high input impedance offered by these resistors minimizes circuit loading and optimizes measurement accuracy.

PN 690385 May 1998 Rev. 1, 7/17
©1998-2017 Fluke Corporation. All rights reserved.
Specifications are subject to change without notification.
All product names are trademarks of their respective companies.

Safety Information







A **Warning** identifies conditions and procedures that are dangerous to the user. A **Caution** identifies conditions and procedures that can cause damage to the Product or the equipment under test.

Warning

To prevent possible electrical shock, fire, or personal injury:

- Read all safety information before you use the Product.
- Do not use the Product around explosive gas, vapor, or in damp or wet environments.
- Examine the case before you use the Product. Look for cracks or missing plastic.
- Do not use test leads if they are damaged. Examine the test leads for damaged insulation and measure a known voltage.
- Do not alter the Product and use only as specified, or the protection supplied by the Product can be compromised.
- When you do a measurement, never make body contact with the probe tip or red portion of the Product. Always hold the Product by its black handle.
- Do not use this probe to measure high voltages on power distribution systems.
- Connect the protective earth alligator clip lead to a known good earth ground.
- Do not apply more than the rated voltage between the terminals or between each terminal and earth ground.
- Have an approved technician repair the Product.
- Do not use the Product if it is altered or damaged.
- Disable the Product if it is damaged.

Symbols

Symbol	Definition
	WARNING. HAZARDOUS VOLTAGE. Risk of electric shock.
	WARNING - RISK OF DANGER. Consult user documentation.
	Double Insulated
	Earth
	Conforms to European Union directives.
	Certified by CSA Group to North American safety standards.
	This product complies with the WEEE Directive marking requirements. The affixed label indicates that you must not discard this electrical/electronic product in domestic household waste. Product Category: With reference to the equipment types in the WEEE Directive Annex I, this product is classed as category 9 "Monitoring and Control Instrumentation" product. Do not dispose of this product as unsorted municipal waste.

Operation

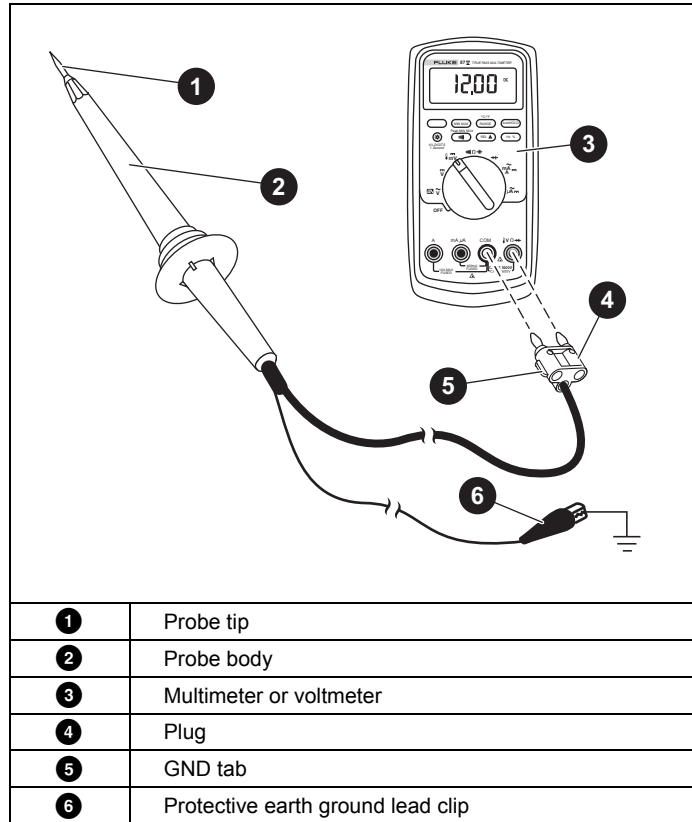

Use the probe as follows:

1. Inspect the probe.
2. Connect the ground lead of the probe to earth ground.
3. Connect the probe cable to a compatible voltmeter. Use a shunt resistor if required.
4. Select the 10 M Ω voltage range (1 V reading for 1000 V probe input).
5. Hold the probe by the black handle and connect the probe tip to the circuit.
6. Observe the voltmeter reading.

Theory Of Operation

The probe is a passive attenuator. See Table 1. High input impedance, accuracy, and stability characteristics are achieved with thick-film resistors. When the probe is connected to a voltmeter with a 10 MΩ input resistance the probe becomes an accurate 1000:1 divider. This divider depends on a ground lead to complete the low side of the circuit path. The connection must always be secure before you do the voltage measurement. Otherwise, instrument damage or a shock hazard can result.

Table 1. Schematic Diagram

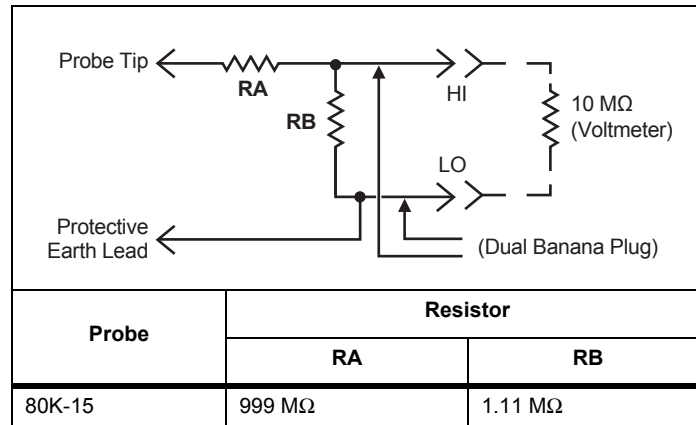

Voltmeter Compatibility

Accuracy of the meter is not included in the accuracy of the probe and must be added to the probe accuracy to determine system accuracy.

The probe is mechanically compatible with any ac or dc voltmeter or multimeter that accepts a standard double banana connector (spaced 0.75" [19 mm]) with standard plugs (0.160" [4 mm]).

The probe is electrically compatible with any ac or dc voltmeter or multimeter that has an input impedance of 10 MΩ ±1 %.

Voltmeters or multimeters with other input impedances require the use of an external shunt or a correction factor to obtain an accurate measurement. Higher impedance voltmeters or multimeters should be equipped with a shunt, and lower impedance voltmeters or multimeters should be assigned correction factors.

Use this formula to determine the value of an external shunt resistor (meter impedance >10 MΩ):

$$R_s = \frac{R_m \times 10}{R_m - 10}$$

Where: R_s = Shunt resistance in MΩ
 R_m = Voltmeter input impedance in MΩ (>10 MΩ)

Example: If $R_m = 20$ MΩ,

$$R_s = \frac{20 \times 10}{20 - 10} = \frac{200}{10} = 20 \text{ M}\Omega$$

Use this formula to calculate a correction factor (meter impedance <10 MΩ):

$$C_f = \frac{1.11 + R_m}{1.11 \times R_m}$$

Where: C_f = Correction factor (multiplier for meter reading)
 R_m = Voltmeter input impedance in MΩ

Example: If $R_m = 1$ MΩ,

$$C_f = \frac{1.11 + 1}{1.11 \times 1} = \frac{2.11}{1.11} = 1.901$$

A meter reading of 0.526 volts represents an input of:

$$0.526 \times 1.901 = 1 \text{ or } 1 \text{ kV}$$

Circuit Loading

The probe represents a load to the circuit of 1000 MΩ , or 1 μA/1 kV.

Maintenance

The probe has no user-serviceable parts.

Use a soft cloth dampened with distilled water to clean the probe. Never use solvents of abrasive cleaners. Make sure the probes are dry before use.

Performance Test

Verify the accuracy of the probe with a 15 kV dc (±0.25 %) voltage source. When used with a compatible dc voltmeter, the probe should measure the source with ±1 % accuracy. No calibration adjustments are available on the probe.

Specifications

Voltage Range:	0 kV to ± 15 kV dc or peak ac, 10 kV rms ac
Input Resistance:	1000 M Ω
Division Ratio:	1000:1 (1000 x attenuation)
Accuracy dc:	± 2 % in 10 °C to 45 °C
Accuracy ac:	± 5 % @ 60 Hz, in 20 °C to 30 °C
Safety:	IEC 61010-031, Type B, Pollution Degree 2, Transient overvoltage limited to 60 kV peak
Temperature	
Operating:	0 °C to 50 °C
Storage:	-20 °C to +60 °C
Relative Humidity:	80 % @ 30 °C 50 % @ 40 °C
Altitude:	2000 m
Dimensions (L x W)	36 cm x 7.5 cm (14 in x 3 in)
Weight	204 g (7.2 oz)

LIMITED WARRANTY AND LIMITATION OF LIABILITY

This Fluke product will be free from defects in material and workmanship for one year from the date of purchase. This warranty does not cover fuses, disposable batteries, or damage from accident, neglect, misuse, alteration, contamination, or abnormal conditions of operation or handling. Resellers are not authorized to extend any other warranty on Fluke's behalf. To obtain service during the warranty period, contact your nearest Fluke authorized service center to obtain return authorization information, then send the product to that Service Center with a description of the problem.

THIS WARRANTY IS YOUR ONLY REMEDY. NO OTHER WARRANTIES, SUCH AS FITNESS FOR A PARTICULAR PURPOSE, ARE EXPRESSED OR IMPLIED. FLUKE IS NOT LIABLE FOR ANY SPECIAL, INDIRECT, INCIDENTAL OR CONSEQUENTIAL DAMAGES OR LOSSES, ARISING FROM ANY CAUSE OR THEORY. Since some states or countries do not allow the exclusion or limitation of an implied warranty or of incidental or consequential damages, this limitation of liability may not apply to you.

11/99