

MGA *prime*

USER MANUAL



9452EN-PR

Find Quality Products Online at:

www.GlobalTestSupply.com

sales@GlobalTestSupply.com

Content

1	Introduction	5
1.1	Intended use.....	5
1.2	About us.....	6
2	Information for product and safety	7
2.1	Safety manual	7
2.2	Safety precautions.....	7
3	Description	8
3.1	Task	8
3.2	Gas flow diagram	8
3.3	The measuring instrument.....	9
3.4	Connectors.....	10
3.5	Probes	10
3.6	Gas sampling probe "TR"	11
3.7	Gas conditioning.....	11
3.8	IR measurement	12
4	Operation	13
4.1	Commissioning.....	13
4.2	Switch on	13
4.3	Switch off / Reset	13
4.3.1	Switch off.....	13
4.3.2	Reset.....	13
4.4	Operating panel	14
5	Settings	15
5.1	Analyzer settings.....	15
5.2	Setting time and date	16
5.3	Configuration of measurement program	16
5.4	Gas flow measurement.....	18
6	Measurement	19
6.1	Preparation of each measurement.....	19
6.1.1	Power supply.....	19
6.1.2	Charging state of the battery	19
6.1.3	Connections to the instrument	19
6.1.4	Operating temperature	20
6.1.5	Filter.....	20
6.1.6	Switch-on, warm-up phase, zero point.....	20
6.1.7	Instrument leak test.....	21
6.2	How to take a Measurement.....	21
6.2.1	Fuel type selection and O ₂ reference.....	21
6.2.2	Store the measurement results	22
7	Maintenance and cleaning	23
7.1	Cleaning and maintenance.....	23

8	Data memory	24
8.1	Organization of the Data memory	24
8.2	Information about the data memory	24
8.3	Site administration	24
8.4	Data transfer via USB (CSV export)	26
8.5	Export of measurements.....	26
9	Extras	27
9.1	Access key.....	27
9.2	Internal Log Settings	27
9.3	Service values.....	28
9.4	Analog output setup (4 – 20 mA).....	28
9.4.1	Setting of lower limit (4 mA):.....	29
9.4.2	Setting of upper limit (20 mA):	29
9.4.3	Setting analog outputs during zeroing.....	29
9.4.4	Pin assignment of the 4-20 mA interface.....	30
9.5	Info	30
9.6	Options.....	30
10	Information on the instrument components	31
10.1	Firmware update.....	31
11	Specifications	32
11.1	NDIR measured values	32
11.2	Technical data	32
11.4	Gas sampling and conditioning	33
11.4.1	Electrochemical-, temperature- and pressure sensors	33
11.5	Calculated values	34
11.5.1	Data communication.....	34
11.5.2	Analysis and calculations	34
11.6	Fuel types.....	35
12	Appendix	36
12.1	Error diagnosis regarding the measuring instrument.....	36
12.2	Insert a static IP-address.....	37
12.2.1	Settings for the software MRU4win	39
12.3	Spare parts	41
13	Declaration of conformity	42

1 Introduction

- This manual enables you to understand and safely operate this MRU Analyzer **MGA***prime*.
- Please read this manual with great vigilance and get familiar with the product before using it.
- This analyzer may only be operated by competent personnel and for its intended use.
- Please pay special attention to all safety directions and warnings to prevent personal injuries and damaging of the product.
- We can't be held responsible for any injuries and/or damages that occur by not following the instructions in this manual.
- Always keep the manual near you when working with the analyzer, to be able to read instructions as needed.
Please ensure to hand over all documents to when handing the analyzer over to others.

1.1 Intended use

The Analyzer **MGA***prime* is designed for the gas analysis of flue gases, as they are emitted from gas/oil burners, engines, or heating and power appliances.

The instrument is intended to support the user in control and indicative measurements in an efficient, accurate and reliable way

The analyzer is specifically not intended as a safety device or personal protective equipment; it should not be used as a warning device to warn people against the presence of harmful gases.

The instrument was manufactured according relevant normatives and regulations. It has to used within it's intended use.

The Instrument must not be modified from the design or safety engineering.

Modifications of any kind by the user will render the declaration of conformity.



This instrument meets the requirements of the valid European and national regulations.
You can find the declaration of conformity in the appendix.

Syntax

Please note that this manual makes use of the scientific notation of gases (NO_2), while the instrument itself and its screen shots display the gases in upper case letter only, i.e. (NO2).

2 Information for product and safety

2.1 Safety manual

All general information and safety precautions of MRU products are listed in the supplied separate safety manual.

Therefore this manual must be read and observed before the first use of the instrument.

Instrument-specific safety and warning requirements in this manual are prefixed before dangerous actions.

2.2 Safety precautions

The used category's of safety precautions are here explained once more.



⚠ DANGER

Identifies an immediate, impending hazard that, if ignored, will result in severe bodily injuries or death.



⚠ WARNING

Identifies an immediate, impending hazard that, if ignored, may result in severe bodily injuries, material damage or death.



⚠ CAUTION

Identifies a possibly dangerous situation that, if ignored, may result in minor injuries.



ATTENTION

Identifies a possibly harmful situation that, if ignored, may result in damages to the device or its surroundings.



NOTE

Identifies user tips and other especially important information.

3 Description

3.1 Task

The instrument is designed for the gas analysis of flue gases, as they are emitted from gas/oil burners, engines, or heating and power appliances. The instrument is intended to support the user in control and indicative measurements in an efficient, accurate and reliable way

The instrument provides a full set of all equipment and sensors required for a emission control measurement:

- heated probe incl heated filter
- heated sample line
- gas conditioning unit including filters and gas cooler
- gas pump and flow control
- gas sensors

Available accessories include sensors for temperature or flow measurement.

The user interface allows for a modern and intuitive way to operate the instrument. Running a commercial LINUX operating system, it allows as well for lot of options for data transfer and storage.

For an overview on all available options please refer to the company's home page or sales representatives.

3.2 Gas flow diagram

The analyzer draws a sample of the flue gases from the duct using a built-in gas pump through the probe is cleaned and dried using a gas cooler and built-in filter and analyses the extracted gas with electrochemical and NDIR sensors.

Draft and temperature are measured at the tip of the sampling probe.

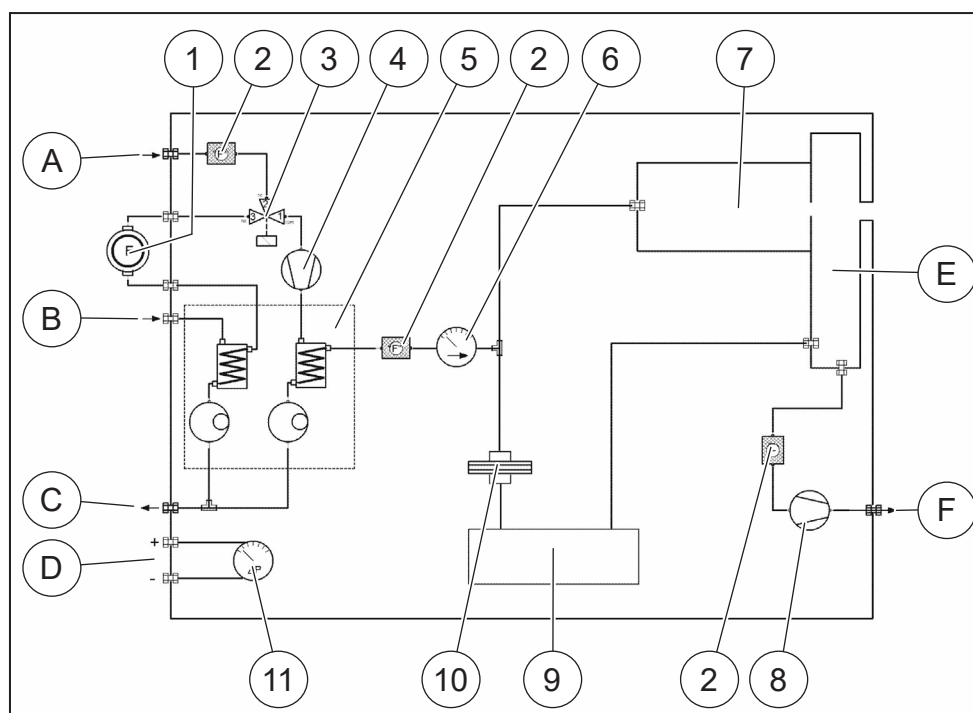

A	Fresh air inlet	B	Sample gas inlet
C	Condensate outlet	D	Diff. Pressure connector
E	Vent collection box	F	Vent outlet
1	Sample gas filter (PTFE)	2	Dust filter
3	Auto-zero solenoid valve	4	Sample gas pump
5	Double stage gas cooler	6	Sample flow sensor
7	Oxygen sensor O2-ECS or O2 paramagnetic	8	Vent pump
9	Infrared (NDIR) bank	10	Acrodisc PTFE filter
11	Diff. pressure sensor		

3.3 The measuring instrument

The measuring instrument consists of a compact and robust metal housing with shock-absorbing rubber corners. All electrical and pneumatic connections are located on the both front sides of the instrument. It is operated exclusively via the touch-sensitive touch screen.



3.4 Connectors

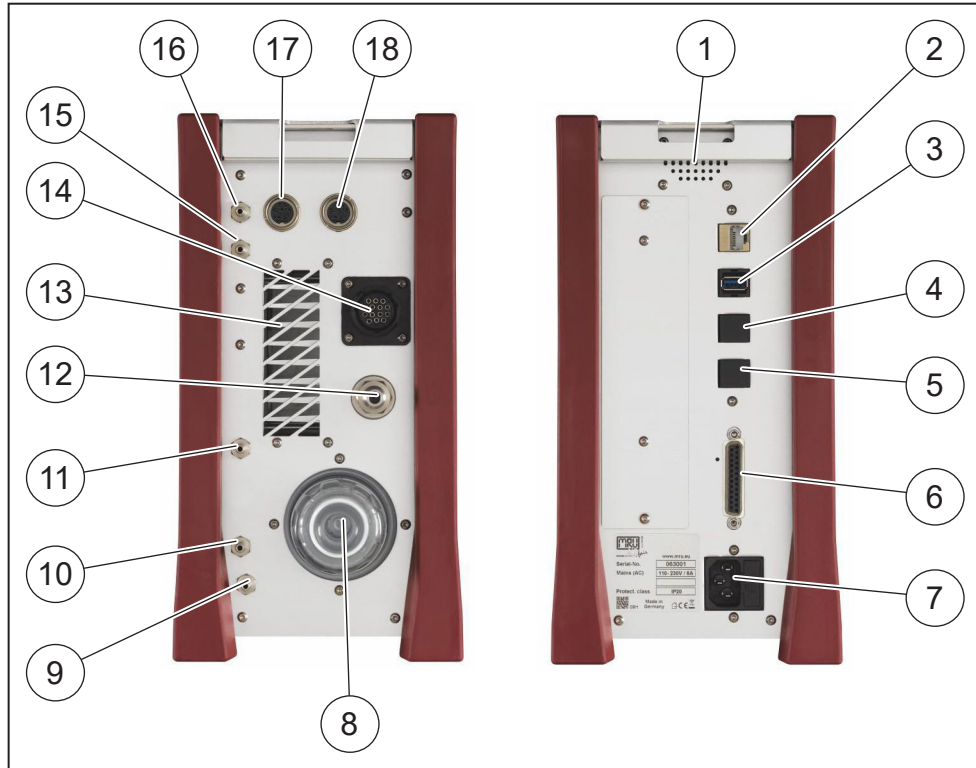

1	Loudspeaker	2	Ethernet (LAN)
3	USB socket	4	Second USB socket (Option)
5	RS485 (Option)	6	Analog outputs 4 ... 20 mA
7	Mains power supply	8	Sample gas filter
9	Condensate outlet port Hose connection DN 4/6	10	Sample gas outlet port (VENT) Hose connection DN 4/6
11	Fresh air inlet port	12	Sample gas inlet port
13	Outlet fan of gas cooler	14	Outlet fan of gas cooler
15	Pressure-/diff. pressure	16	Pressure-/diff. pressure (Absolute pressure)
17	Combustion air temperature	18	AUX socket

3.5 Probes

The Analyzer is available with different probes, both with fixed and exchangeable probe tubes.

- for high and less dust content
- for fuel temperatures up to 800 °C (stainless-steel probe tube),
- for fuel temperatures up to 1.200 °C (Inconel steel probe tube),
- for fuel temperatures up to 1.700 °C (ceramic probe tube)
- with and without heated pre-filter
- with and without heated gas sampling line
- probe tubes in different lengths, from 300mm to 2000mm

A complete list of available probes can be found in the current price list of this analyzer.

3.6 Gas sampling probe "TR"

Heated probe with heated and exchangeable glass filter. The probe tube includes a gas temperature sensor and is available in different tube lengths.

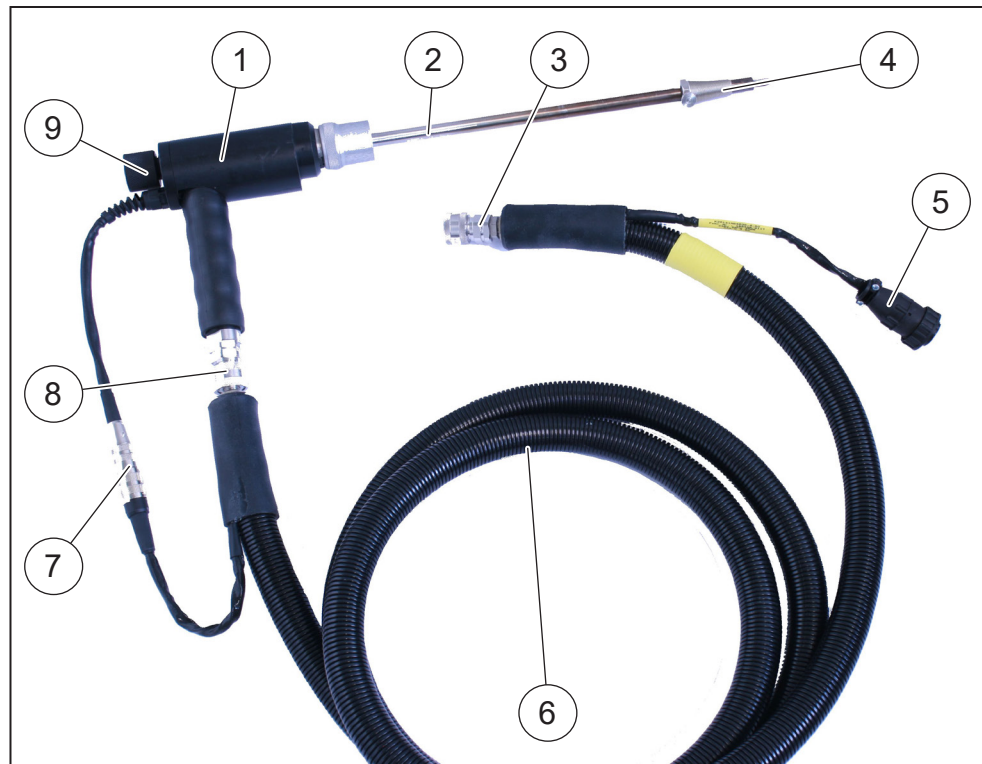

1	Probe handle	2	Probe tube
3	Fast locking coupling	4	Probe cone
5	Cable plug (14-pin)	6	Heated hose line
7	Cable coupler (5-pin)	8	Fast locking coupling
9	Filter lock		

3.7 Gas conditioning

The sucked sample gas is dried and filtered before it is fed to the sensors. A double stage sample gas cooler with Peltier element is used for drying. The condensate liquid appearing in the gas cooler is pumped to the condensate outlet by means of a peristaltic pump. The condensate forms drops at the outlet of the instrument.

Optionally, connect a hose (DN 4/6) to the condensate drain.

The VENT output delivers the sample gas after the analysis stage. If for subsequent filtering, a round filter is used on the front of the measuring instrument.

3.8 IR measurement

The instruments NDIR gas sensor is able to detect up to 8 different gases. It is most advanced in terms of its long-term stability due to a dedicated stabilization technology including a permanent zeroing by operating the bench at two different gas pressure values.

Due to its low noise and being drift free, it is perfectly suited to long-term measurements.

Principle of the IR-bench (NDIR)

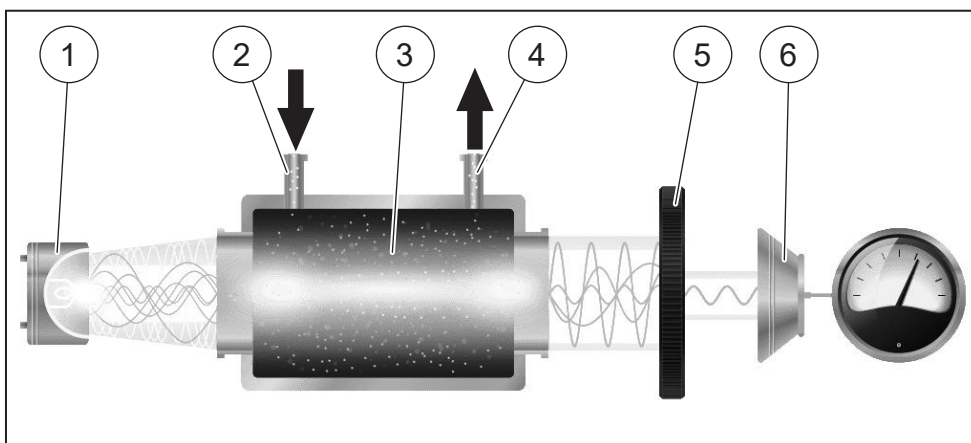

1	IR source	2	Gas entry
3	Sample gas cell	4	Gas exit
5	Band pass filter	6	IR detector

An infrared source delivers IR radiation in the wavelength range between 1 and 10 μm , which is relevant for the absorption of gas components to be measured.



The target gas absorbs a portion of the IR radiation, which is detected by a wavelength selective detectors and the end of the sample gas cell. The absorption value is correlated with the gas concentration, while all effects of cross sensitivity to other gases are corrected by an internal software algorithm.

As the IR bench is operated successively at two different gas pressure values, it is possible to eliminate all drift effects, which would otherwise contribute to the absorption signal.



4 Operation

4.1 Commissioning

The instrument is delivered as a complete assembly ready for use.

- ▶ Check the instrument regarding condition and integrity after delivery.
 - ▶ Connect the instrument to the power grid.
 - ⇒ The instrument switches on and start the operating system.
 - ⇒ Blue LEDs for ON and power supply are switched on.
 - ⇒ The instrument runs a start procedure which includes:
 - self test
 - warm-up of the NDIR bench
 - cool down the double stage gas cooler, indicated by the symbol 
 - Zeroing, indicated by symbol 
 - ▶ Charge battery for more than 8h is recommended after first start to allow the battery to charge completely. Operation of heated probe and sample line is only supported when connected to power grid.
 - ⇒ The battery is charged as soon as the connection to power grid is established.
 - ⇒ The blue LED will be blinking slowly.
- Heating of probe and probe tube are unsupported in battery mode.

4.2 Switch on



- ▶ Touch the  button for 3 sec. minimum
 - ⇒ LED lights blue
- ▶ Release the  button
 - ⇒ LED lights red, analyzer runs up

4.3 Switch off / Reset

4.3.1 Switch off

- ▶ Touch the "Context menu" on the display
 - ▶ "Turn instrument off"
 - ⇒ Do you wish to turn instrument off?
 - ▶ "YES"
 - ⇒ "The system will shut down"
- or
- ▶ Touch the  button
 - ⇒ Do you wish to turn instrument off?
 - ⇒ "YES"
 - ⇒ "The system will shut down"

4.3.2 Reset

- ▶ Touch the  button during flashing LED for 30 sec. minimum
- ▶ After change to continuous lighting, release the  button
 - ⇒ The instrument will switching off with reset

4.4 Operating panel

All functions are controlled via the touch surface of the instrument. Different gestures are available in the individual menus and windows.

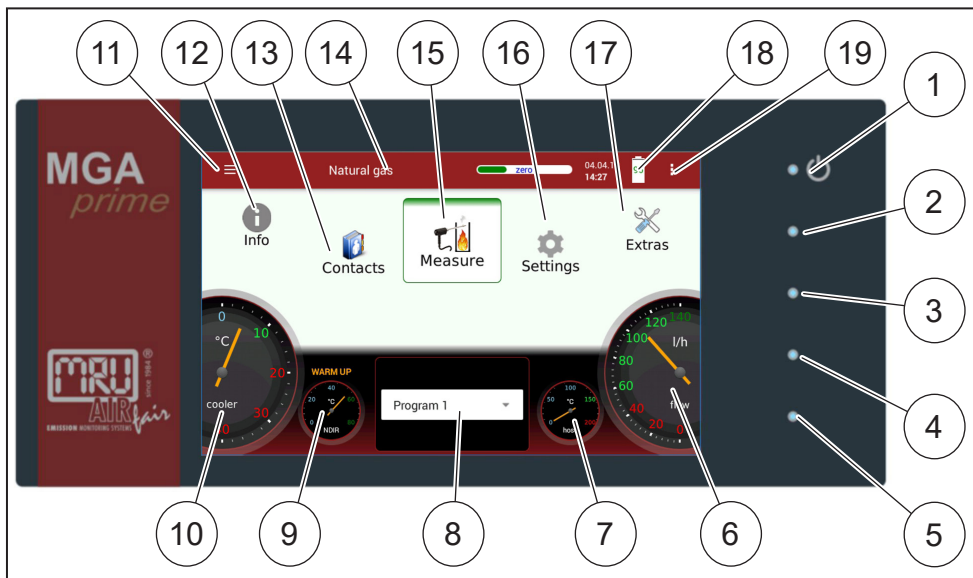

1	Power-on and reset
2	Reserve
3	Reserve
4	LED display mains operation/battery charging mode
5	Reserve
6	Current flow rate
7	Current temperatures heated hose
8	Selected measuring program, e.g. Test or measurement program
9	Current temperatures of NDIR bench
10	Current temperatures of gas cooler
11	Access to detailed information on the instrument components. Especially for service or inquiry
12	Menu info
13	Menu contacts
14	Status bar: display of zero point, alarms, executed measuring program, selected fuel, heat-up-, cool-down phase
15	Menu measure
16	Menu settings
17	Menu extras
18	Battery Charge indicator
19	Context menu with window-dependent additional functions

5 Settings

After the analyzer has been inspected and is ready for start-up it can be switched on and personalized settings can be entered. These settings can be changed at any time.

5.1 Analyzer settings

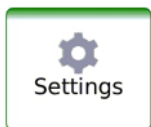

After the analyzer has been inspected and is ready for start-up it can be switched on and personalized settings can be entered. These settings can be changed at any time.:

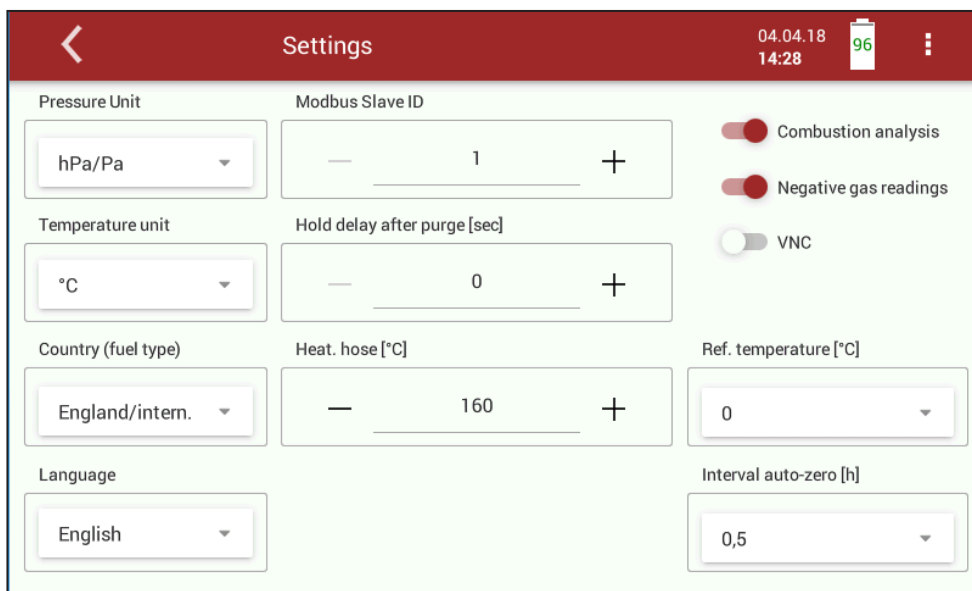

Country	Option	 <p>By changing the country the O2 reference values settings are lost. The fuel list is reset. Similarly, country-specific defaults and methods of measurement are selected as a result. Ensure the correct setting of the country in which you are performing the measurement to ensure that all relevant ones are set up</p>
Language	Option	Select instrument languages
Modbus slave		Modbus address of the instrument for the remote control via Modbus
Temperature heating hose	130°C - +180 °C	
Combustion analysis	on/off	Setting combustion analysis to ON allows for several calculation performed by the instrument, which are fuel type dependent, e.g. Lambda, heat loss.

Negative gas readings	on/off	Negative gas readings Caused by temperature drift of a sensor are suppressed (shown as zero) or displayed
VNC	on/off	VNC Viewer for remote control via LAN
Reference temperature		Calculation of the values for a standard state at reference temperature
Interval auto-zero		Interval time after which the instrument performs a zero-point

5.2 Setting time and date

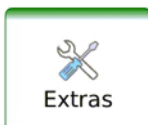

In the **Extras** menu, you can check the date and time and, if necessary, set it. When connected to the Internet, the time automatically synchronizes itself.

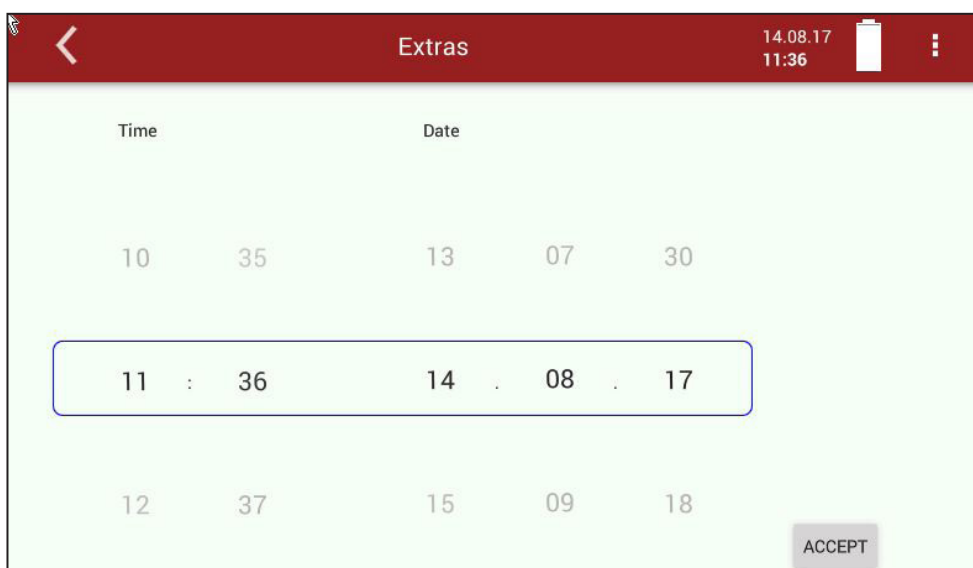

- ▶ The time and date can be set in the middle black number series by pushing up and down the gray number row.
- ▶ Accept the changes with ACCEPT.

5.3 Configuration of measurement program



The Analyzer provides in the **Measure** menu various measurement programs, which can be selected in the main window. Each measuring program defines the properties of the measuring window:

- **Measurement program**

The measured value window can be freely set with regard to the displayed measured values, of the underlying fuel. The purge limit of the CO sensor (if available) can be set

- **Test program**

The measured value window shows predefined values and cannot be changed. Can be used in instrument testing to obtain standardized displays, e.g. can easily be checked with test gases.

- **If so, further measuring programs**

The measurement window for gas analysis can be configured and adapted to your needs. The measuring window initially displays 12 measured values, by a scrolling gesture it will display more values.

O ₂ [%]	CO [ppm]	Cooler [°C]
20.36	0.0	5.0
NO ref3%O ₂ [mg/Nm ³]	Losses [%]	NO _x [ppm]
0	100.0	0.6
CO ₂ [%]	Air ratio []	T-gas [°C]
0.34	---	---
CO [mg/kWh]	Eff. ncv [%]	CO ref0%O ₂ [ppm]
0	---	0

Moving a value field

- ▶ Touch and hold the value field.
 - ⇒ Value field will be framed.
- ▶ Move the value field to a different position.
 - ⇒ The other value fields move automatically.

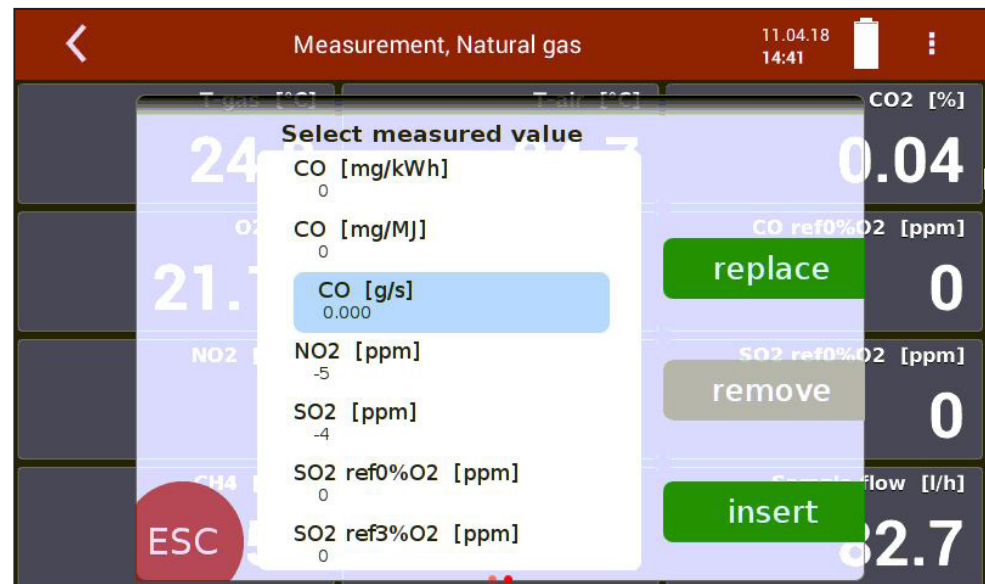

Assign a measured value

- ▶ Double touch the value field.
 - ⇒ A list with of all available measured values is displayed.
- ▶ Choose the wanted value and "replace".

5.4 Gas flow measurement

Set up measurement window

With the flow measurement option are further measurements available:

- v-flow
- Flow rate
- Mass flow carbon

Parameter for gas flow measurement

► Choose the right context button - menu item "gas flow measurement".

The screenshot displays a mobile application interface for gas flow measurement. The title bar at the top reads "Measurement, Natural gas" and shows the date "11.04.18" and time "14:25". The main display area is a grid of measurement parameters:

Parameter	Value
T-gas [°C]	24.7
T-air [°C]	24.5
O2 [%]	---
CO [ppm]	---
NO2 [ppm]	---
SO2 [ppm]	---
CH4 [ppm]	---
C3H8 [ppm]	---
Flow measurement	87.5

A context menu is open on the right side of the screen, listing the following options:

- O2ref / Fuel type
- Zero point gas
- Zero point pressure
- Store
- Print
- Start logging
- Gas flow measurement

6 Measurement

6.1 Preparation of each measurement

6.1.1 Power supply

The analyzer can be operated with an internal battery to warm up the instrument or to use internal instrument functions. A mains connection is required for the measurement including heated gas sampling probe and heating hose.

6.1.2 Charging state of the battery

The battery symbol in the display indicates approximately the remaining capacity of the battery.

From 2% remaining capacity, the charging indicator starts to flash red. If the instrument is not connected to the mains power supply within one minute, the analyzer switches off to prevent battery discharge.

Even when the battery is discharged, the instrument can be operated completely on the power supply.

6.1.3 Connections to the instrument



⚠ CAUTION

Acid from the condensate

Acid burns may result from weakly acidic liquids from the condensate.

- ▶ If you come into contact with acid, wash the area immediately using a lot of water.



⚠ DANGER

Risk due to toxic gases

There is a risk of poisoning.

Noxious gases are sucked in by the measuring device and released into the ambient air.

- ▶ Only use the measuring device in well ventilated spaces.
- ▶ Connect the gas sampling probe to the instrument (gas plug and electrical plug).
- ▶ Consider to connect a hose or collecting container if necessary to the condensate outlet when appropriate.
- ▶ The hose and any connected reservoir connected to the outlet must not be closed against ambient or include an air outlet to avoid over-pressure.
- ▶ Please note that measuring gas may leak at the instrument side or at the VENT outlet. Connect a pump to the VENT output to collect the sample gas. If an "active VENT" option is installed, an internal gas pump feeds the sample gas completely to the VENT outlet, where an evacuating gas hose should be connected.
- ▶ In the case the option active vent is installed, note that the sample gas at the exit may be diluted with ambient air and is therefore not adequate to be reused in the process.
- ▶ Ensure that ambient fresh air can be sucked in at the fresh air inlet. Consider to connect a hose leading to fresh ambient air, when the instrument's environment contains toxic gases or a high CO₂ level.

- ▶ The flow rate of the gas should be within the specified range. Otherwise, please check probe and filter for clogging
- ▶ Temperatures of NDIR and heating hose should be within the specified range in order to guarantee a sufficient measuring accuracy.

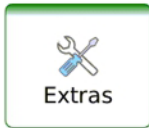

In the **Extras** menu under "Connections" the connection drawings are displayed:

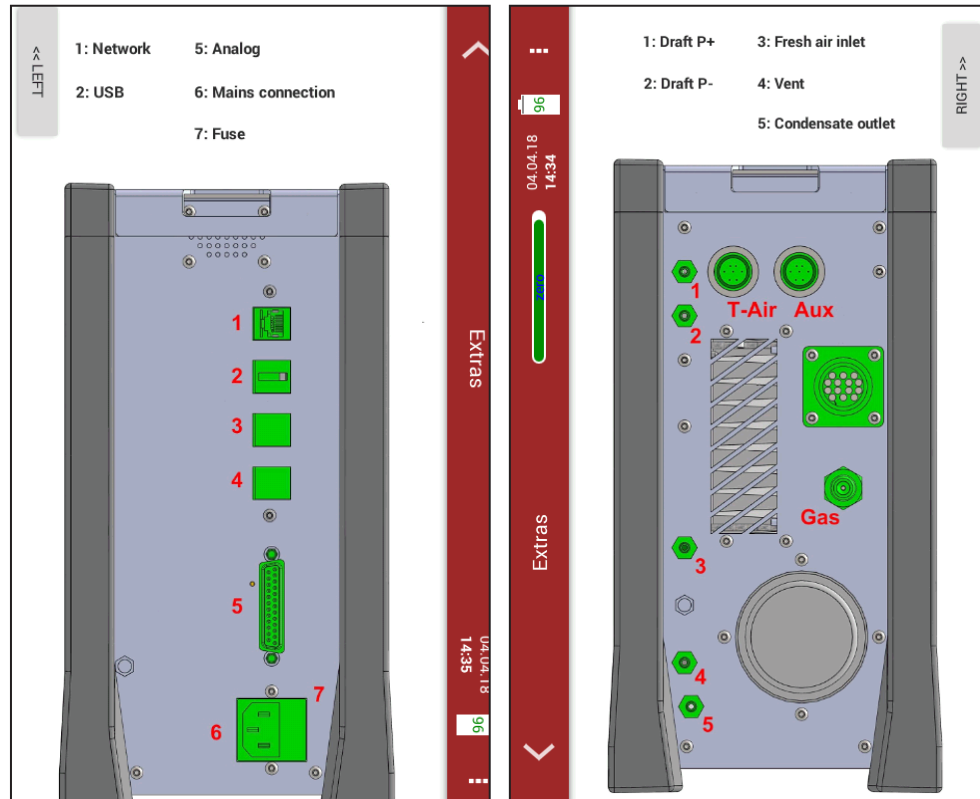

6.1.4 Operating temperature

The internal gas cooler operates at 5°C, which is the dew point of the sample gas to the sensors. Components along the gas line may be damaged if they are colder than 5°C and condensation appears internally. Therefore, if the Analyzer has been stored very cold below 0°C, it is essential to wait for the Analyzer to warm up in a warm environment in order to avoid such condensation! In such cases, take a typical warm-up time for the instrument of one hour into account, especially when wet flue gases are to be measured.

If the operating temperature is not within the permissible range, a corresponding message is displayed.

6.1.5 Filter

The probe filter and the round filter must be checked before and after each measurement

6.1.6 Switch-on, warm-up phase, zero point

After switching on, the instrument can always be operated, even if no gas analysis can take place during the warm-up phase. The instrument independently performs the following actions during the warm-up phase:

- Heating the probe and the heating hose
- Warm up the NDIR bench (if available)
- After the operating temperatures have been reached, the gas pump is switched on and the analyzer takes the zero point with fresh air.
- After the zeroing, the analyzer is ready for operation

If a new zero point is required by further heating the instrument, it can be started via the context menu.

6.1.7 Instrument leak test

- ▶ Check all connections for correct fit.
- ▶ Check all hoses and hose connections (from the tip of the probe to the gas inlet of the measuring instrument) for leaks.

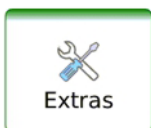

The Analyzer has a built-in “leak test” in menu **Extras** for checking the tightness of the gas paths. This is done by measuring the remaining gas flow when the gas path is closed.

- ▶ Seal the sample gas inlet
- ▶ If the complete gas path is to be tested for leakage - at the probe tip. If the system is tight, the traffic light is green and the l / h pointer points



to 0.

6.2 How to take a Measurement



6.2.1 Fuel type selection and O₂ reference

The fuel selection can be selected in the menu **Measure** with the O₂ reference / fuel in the “context menu”.

For this, the combustion analysis have to be switched on, also see 5.1

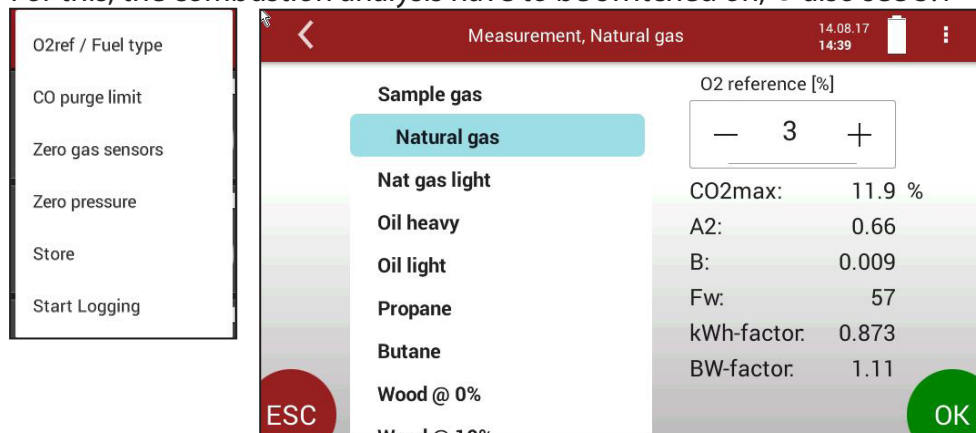

6.2.2 Store the measurement results

The measured values can be stored in a site via the context menu / Store menu entry.

The measurement itself continues until switch off of the analyzer.

Continuous data logging

A continuous measurement logging is possible via the context menu / "Start logging".

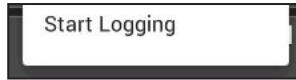

With "Start Logging", the currently measured values are stored in a site every 10 seconds.



End the data logging with "Stop logging".

7 Maintenance and cleaning

7.1 Cleaning and maintenance

The Analyzer needs only low maintenance effort for long value preservation



⚠ CAUTION

Acid from the condensate

Acid burns may result from weakly acidic liquids from the condensate.

- ▶ If you come into contact with acid, wash the area immediately using a lot of water.

After every measurement:

- ▶ Remove the gas sampling tube from the analyzer, so that the hose can dry.

Occasionally:

- ▶ Cleaning of the probe and the probe tube.
- ▶ after longer disuse load battery first and afterwards approx. all 4 weeks.
- ▶ Check the filter in the probe head (if available), replace if necessary.
- ▶ Check the round filter at the front of the instrument and replace if necessary.

Maintenance

An annual service check and if necessary adjustment of the sensors at an MRU service department (www.mru.eu) are recommended for the preservation of value.

8 Data memory

8.1 Organization of the Data memory

Basis of the data memory of the analyzer is a set of sites stored in the instrument. Every site exists of a unique site number and 12 freely usable text lines which can have, e.g., the address, customer name etc.

The instrument can store up to 1.000 different sites.

Sites can be created in the instrument and be changed. Measurements are stored by assigning them to a site. Measurements can be, on this occasion, singles flue gas measurements or other measuring programs available in the instrument.

8.2 Information about the data memory



In the menu **Contacts**, item "storage" you select "memory info" to get information about the actual memory volume. The part of free memory, the total number of the stored sites and the number of the measurements stored all together, split in the kind of the measurement is listed.

8.3 Site administration

Available sites are listed in this menu

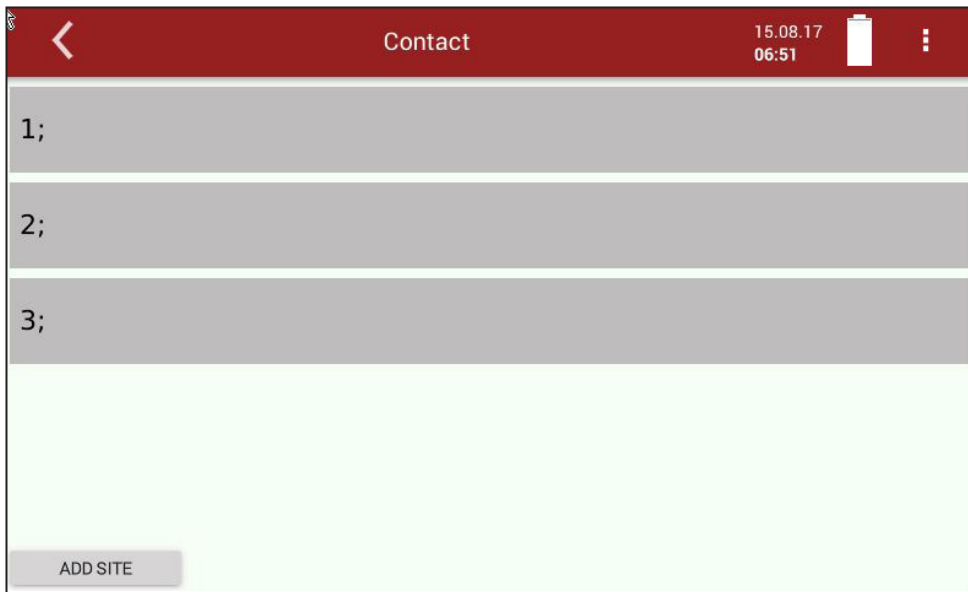

The "ADD SITE" button creates a new site number. Further changes may be introduced after selecting a specific line.

- Changes in the site description may be entered and stored
- A site may be deleted by the “delete” button.
- Measurements assigned to the selected site are displayed when the “Measurement” button is activated.



In the menu **Measure** you can see stored measurements

O2 [%]	Air ratio []	Exc.Air [%]
20.00	---	-100
CO2 [%]	Dewpoint [°C]	Losses [%]
0.54	18.1	100.0
Eff. ncV [%]	Eff. gcV [%]	CO [ppm]
---	---	1.0
CO ref0%O2 [ppm]	CO ref3%O2 [ppm]	CO ref3%O2 [mg/Nm ³]
0	0	0

8.4 Data transfer via USB (CSV export)

The data exchange format is CSV. A character-separated values (CSV) file is a simple text format for a database table. Each record in the table is one line of the text file. Each field value of a record is separated from the next by a character. The analyzer uses a semi-colon ';' as value separator (other implementations use sometimes a comma). CSV is a simple file format that is widely supported, so it is often used to move tabular data between different computer programs, for example Microsoft Excel™ or Access™, that support the format. Also other computer programs offer this type of interface because it is widely spread and easy to use.

The following functions are available

- Export of sites
- Export of flue gas measurements

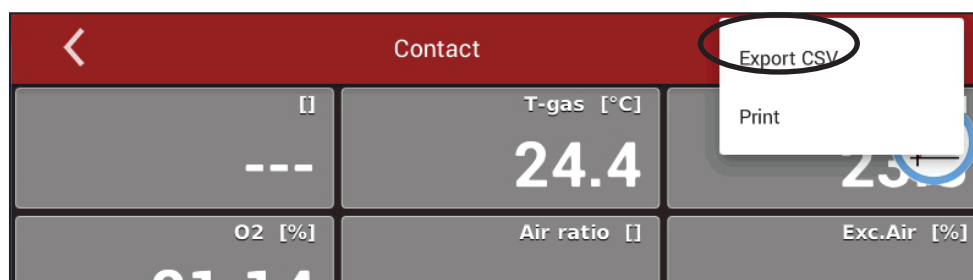

- ▶ Insert USB Stick
- ▶ Select "site" and "measurement" in **Contacts** menu
- ▶ Now press "EXPORT CSV"

After this... you find in the USB stick directory "1113Export" the export files.

The file name is such as those "09_04_2018_15_02_02__Measurement__Natural_gas.csv"...

- ▶ Open this file (*.csv) with Excel.... (don't use the dat files... don't use "Internal log settings" are only for internal use or diagnostics)

A1	Date,Time	,T-gas °C	,T-air °C	O2 %	Air ratio	,Exc.Air %	CO2 %	Dewpoint °C	Losses %	Eff. ncv %	Eff. gcv %	CO %
1	12.04.2018,10:31:33	23.5	23.2	21.32	0.00	0.0	0.000	0.000	0	0	0	0
2	12.04.2018,10:31:35	23.5	23.2	21.32	0.00	0.0	0.000	0.000	0	0	0	0
3	12.04.2018,10:31:35	23.6	23.2	21.32	0.00	0.0	0.000	0.000	0	0	0	0
4	12.04.2018,10:31:36	23.6	23.2	21.32	0.00	0.0	0.000	0.000	0	0	0	0

8.5 Export of measurements

This function is used to export the measurements from the analyzer to a computer program.

Attention, This function is not suitable for back-up or for the transfer to another analyzer because the exported file cannot be imported again! The created file has the name, 'EMIxxxxx.csv', in which the xxxxx are continuing 5 digit numbers with leading zeros.

The created file has a column header with the following information: Site number, Date/Time,

Measuring program name, Fuel type, CO₂max, O₂reference, and all measured values that the analyzer can measure.

9 Extras

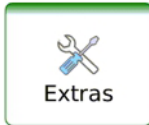

In the **Extras** menu, the time / date setting (chapter 5.2) and the connection possibilities of the instrument (chapter 3.4) are further menu items for service purposes available.

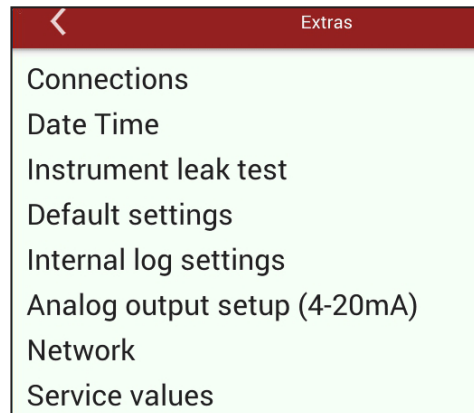

The first menu items have already been explained during “settings”.

9.1 Access key

The entry of an access key (password) is for maintenance action and allows experienced users to operate on the operating system level. Not required for regular use.

9.2 Internal Log Settings

The analyzer stores internal parameters at regular intervals to allow for an optimized support from experienced service staff. These files can be copied to a connected USB stick and sent via email if required to do so.

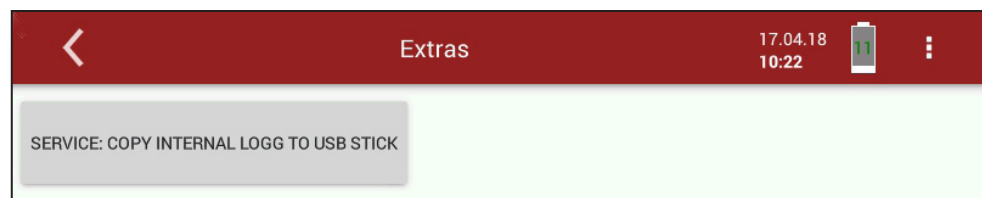

- Copy internal log to USB stick.

9.3 Service values

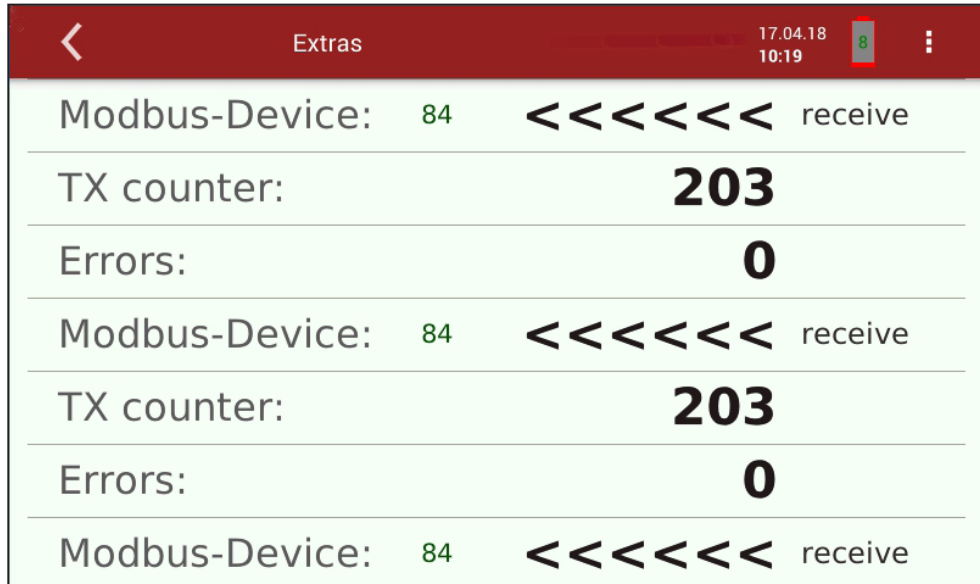

This screen displays a number of internal parameters and their values.

In case of unexpected behavior of the instrument it might be helpful to communicate those values to our worldwide service staff: www.mru.eu

9.4 Analog output setup (4 – 20 mA)

There are 8 analog outputs available (4-20 mA). Each analog output (channel) is assigned a measured variable and an output range.

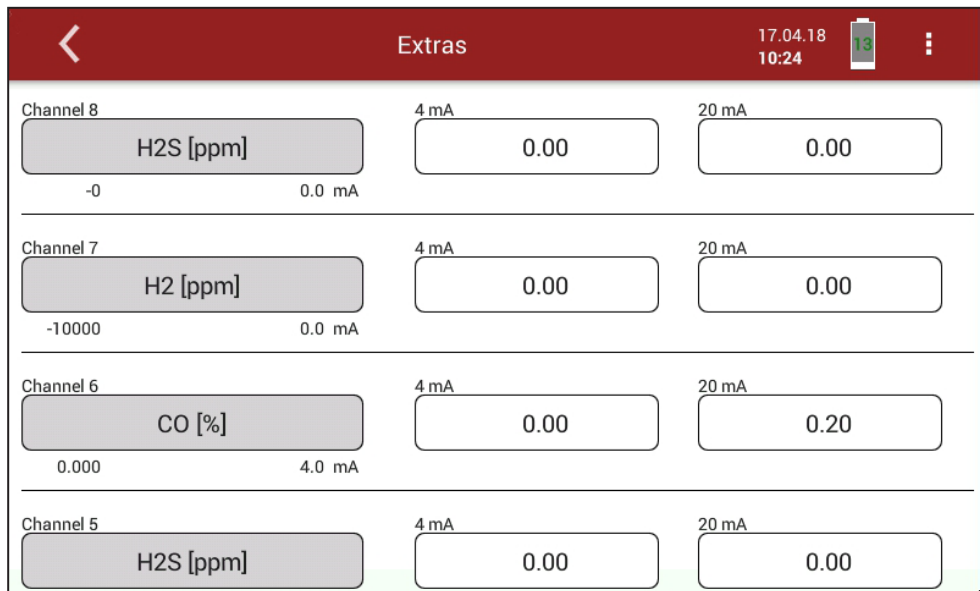

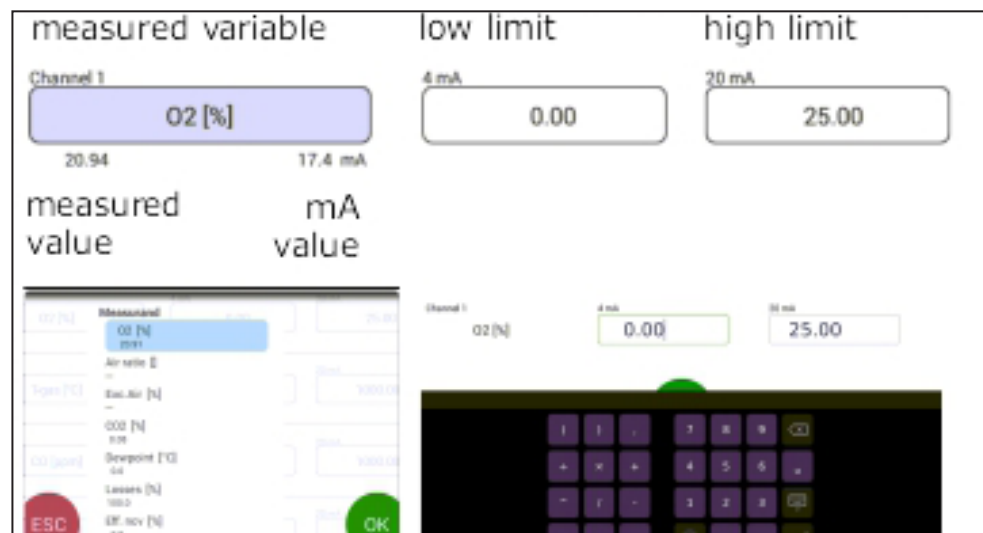

9.4.1 Setting of lower limit (4 mA):

This setting determines the lower end value, corresponding to 4 mA. If the measured value falls below the set value, the analog output stops at 4 mA.

9.4.2 Setting of upper limit (20 mA):

This setting determines the upper end value, corresponding to 20 mA. If the measured value rises above the set value, the value stops at 20 mA.

9.4.3 Setting analog outputs during zeroing

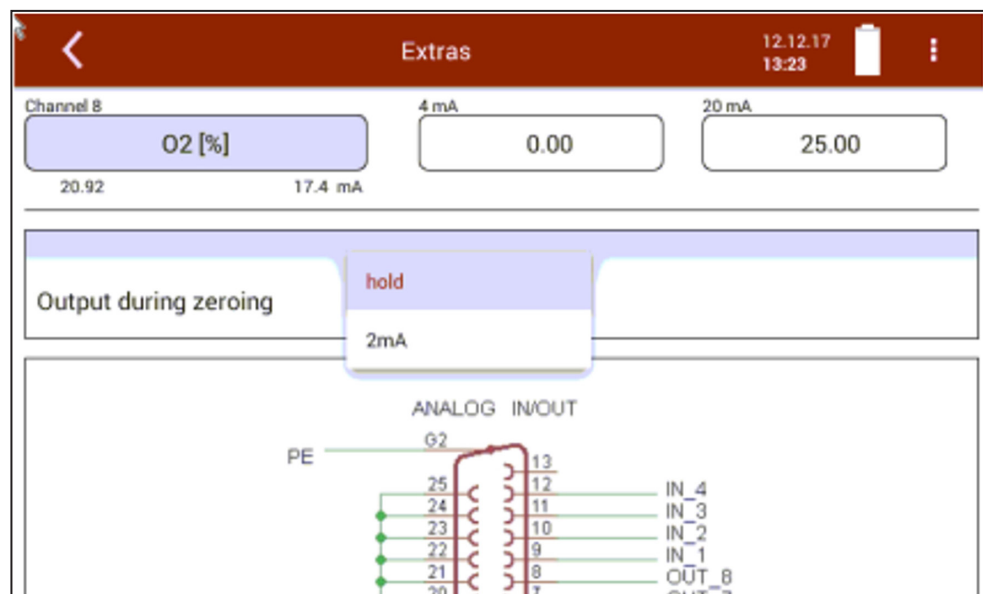

The following settings are possible

- **Hold** - The outputs kept the last values from before zeroing
- **2mA** - The outputs change to 2 mA to indicate the zero point

9.4.4 Pin assignment of the 4-20 mA interface

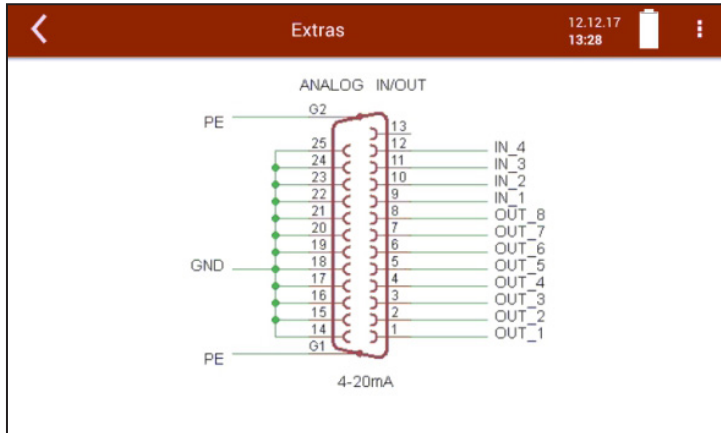

9.5 Info

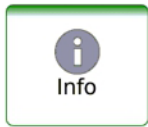

In the Info menu, version information and installed options can be viewed.

Info			
Serial number	063003	Hardware version	V1.00
Firmware version	1.000.076	Production date	20.02.2018
Image Version	1.000.004		
Battery modul info		EC modul info	
Serial number	749999	Serial number	749998
Firmware version	V1.00.06	Firmware version	V1.00.23
Hardware version	V0.00	Hardware version	V1.00
Bootloader version	V0.00.01	Bootloader version	--
Gascooler modul info		NDIR info	
Serial number	0	Serial number	0
Firmware version	V1.00.10	Firmware version	V0.00.00
Hardware version	V0.00	Hardware version	V0.00
Bootloader version	V0.00.02	Bootloader version	V0.00.00

OPTIONEN

9.6 Options

Info	
• Electrochemical Sensors	
Sensor O2	
Sensor H2S 0-2.000/5.000 ppm	
• NDIR Sensors	
CO 0-1,00 up to 10,00 %	
CO2 0-30,00 %	
CH4 0-1,00 up to 4,00 %	
• Other options	

10 Information on the instrument components



Especially for service or inquiry

This menu can be selected from the main menu with the adjacent button.

In addition to special instrument information and the possibility of instrument matching for service stations, a firmware update is also possible.

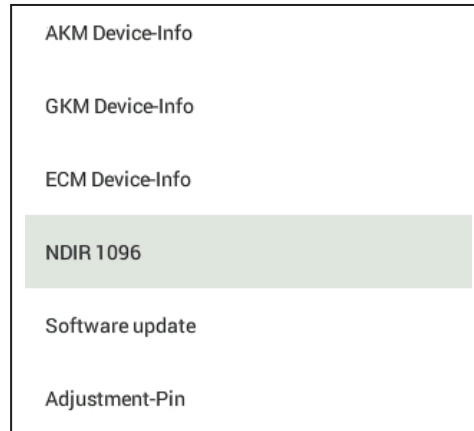

10.1 Firmware update

Performing an update:

- ▶ Please extract the obtained file 1113Update.zip.
- ▶ Copy the unzipped file '1106.fwb' to a USB stick in the root directory.
- ▶ Switch on the analyzer...
- ▶ Insert the prepared USB stick into a USB socket of the analyzer.
- ▶ Press 
- ▶ Select the menu item "Software update"

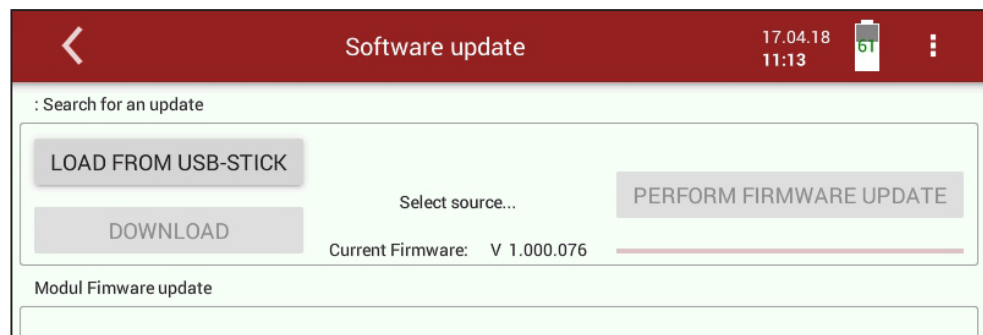

- ▶ "Load from USB Stick"
- ▶ After copying to the analyzer press the button "Perform firmware update"
 - ⇒ The firmware update starts
- ▶ After updating, turn the analyzer off
 - ⇒ After rebooting, the new firmware is installed.

11 Specifications

11.1 NDIR measured values

Gas	Range	Resolution	Accuracy
NO	250 - 4000 ppm	1 ppm	Repeatability: 1% v.MB. (CH4: 2% v. MB) 8h-Drift: 1% v.MB. Linearity: 2% v. MB.
NO ₂	200 - 1000 ppm	1 ppm	
SO ₂	200 - 4000 ppm	1 ppm	
CO ₂	40 Vol%	0,01 Vol%	
CO	200 - 10000 ppm	1 ppm	
N ₂ O	200 - 1000 ppm	1 ppm	
CH ₄	500 - 10000 ppm	1 ppm	
HC (C ₃ H ₈)	200 - 10000 ppm	1 ppm	

11.2 Technical data

Operating temperature	+5°C - +45 °C
Rel. Humidity, non-condensing	90 %
Storage temperature	-20 °C - +50 °C
Internal Battery Pack, capacity, operating hours w/o gas cooler and heated sample line	Li-Ion, 96 Wh, 6 h
Display	7" touch, < 750 cd/m2, 800*480 px
Power supply (w/o heated sample line)	86 - 265 V / 47 - 63 Hz / 105 W
Weight instrument w/ 2 EC sensors.	7,5 kg
Weight instrument w/ 2 EC sensors plus case	16 kg
Size incl Case (WxHxD)	43 cm x 15 cm x 29 cm
Size incl Case (WxHxD)	51 cm x 29 cm x 51 cm
Housing Material	Aluminium / TPU
IP degree of protection	IP20

11.4 Gas sampling and conditioning

11.4.1 Electrochemical-, temperature- and pressure sensors

Electrochemical sensor	O₂ Long Life
Measuring range	0 - 25 Vol%
Resolution	0,01 Vol%
Abs. accuracy	± 0,2 Vol%
Response time T90	< 20s
Years expected lifetime (@air)	5 Jy
Paramagnetic sensor	O₂
Measuring range	0 - 25 Vol%
Resolution	0,01 Vol%
Accuracy	0,1 Vol%
Flue gas temperature	T_A
Measuring Range with high grade steel probe pipe	0 - 800° C
Measuring range with Inconel probe pipe	0 - 1100° C
Short time only (up to 20 mins)	0 - 1350° C
Accuracy abs. / reading	±2° C /
	1%
Air temperature	T_I
Measuring range	0 - 100°C
Abs. accuracy	1 °C
Draft	
Measuring range	± 120 hPa
Accuracy abs. / reading	0,02 hPa
	1 %
Differential Pressure	
Measuring range	± 120 hPa
Accuracy abs. / reading	0,02 hPa
	1 %
Barometric Pressure	P_{abs}
Measuring range	300 - 1200 hPa
Accuracy	± 3 hPa

11.5 Calculated values

Velocity based on differential pressure measurement with Pitot tube	v
Typical measuring range	3 m/s - 100 m/s
Accuracy at 3 m/s	1 m/s
Accuracy > 12 m/s (reading)	± 1%
Resolution	0,1 m/s
Absolute pressure measurement	•

11.5.1 Data communication

USB interface master only (for connection to USB stick or accessories)	O
Support of external SD card reader	O
Ethernet, RJ45	O
WLAN	O
Bluetooth	O
RS485 (AUX socket, for connection of external sensor modules)	O
RS485 (isolated, for connection to PC)	O
Analog I/O: 4x input, 8x output, 4... 20 mA	O

11.5.2 Analysis and calculations

Continuous measured values	Unit
O ₂	[%]
Temp. ambient air (thermocouple)	[°C]
Temp. flue (thermocouple)	[°C]
CO	[ppm]
Draft	[hPa]

Further continuously calculated values	Unit
ETA	[%]
ETA condensed	[%]
Losses	[%]
Losses condensed	[%]
Lambda	-
Dew point	[°C]
CO/CO ₂ ratio	[%]

11.6 Fuel types

This list is for Germany only.

Fuel types from other countries can be obtained from MRU GmbH:

Web page: www.mru.eu

Germany O ₂ max 20,96				
Fuel	CO ₂ max	A1	A2	B
Test gas	0,0	0,00	0,00	0,000
Natural gas (LL)	11,8	0,37	0,66	0,009
Natural gas (E) (*)	12,1	0,37	0,64	0,009
EL heating oil	15,4	0,50	0,68	0,007
S heating oil	15,9	0,50	0,66	0,007
P/B liquid gas	13,7	0,42	0,63	0,008
Propane	13,7	0,43	0,66	0,007
Butane	14,1	0,45	0,67	0,007
Biodiesel	15,7	0,46	0,62	0,005
Dry wood	20,3	0,60	0,62	0,009
Pellets	20,3	0,74	0,77	0,000
Coal	19,1	0,59	0,65	0,009
Lignite	19,4	0,39	0,42	0,009
Peat	19,8	0,66	0,70	0,010
Coke oven gas	10,8	0,29	0,60	0,011
Coal gas	11,7	0,35	0,63	0,011

12 Appendix

12.1 Error diagnosis regarding the measuring instrument

Fault indication	Possible causes	Repair
Gas cooler is faulty! The system will shut down...	Gas cooler faulty	Contact MRU service department
Undervoltage!!! The System will shut down...	Battery is discharged	Connect instrument to power grid.
Power consumption too high" Please check heated hose!	Please check heated sample line.	Heated sample line may be damaged. Disconnect the instrument from power grid and visually inspect the sample line. Take care to unroll the heated sample line before operating it.
Hose temperature is set to 160°C	Sample line temperature set to 160 °C. Heated sample line is only intended to operate at higher temperatures than 160 °C for short time. !	During next power-up the temperature is reduced to 160 °C again..
Please wait – pump is off Warm up has not been completed yet.	Measurement not started as instrument is in warm-up phase..	Wait until warm up phase has terminated.
Flow monitoring! Flow rate too low! Please check filter	The sample gas flow has fallen below the required limit. Filter or sample line may be clogged. Gas pump may be faulty Flow sensor may be defect.	Check sample line and all filters on dust or water. Replace filters.

Fault indication

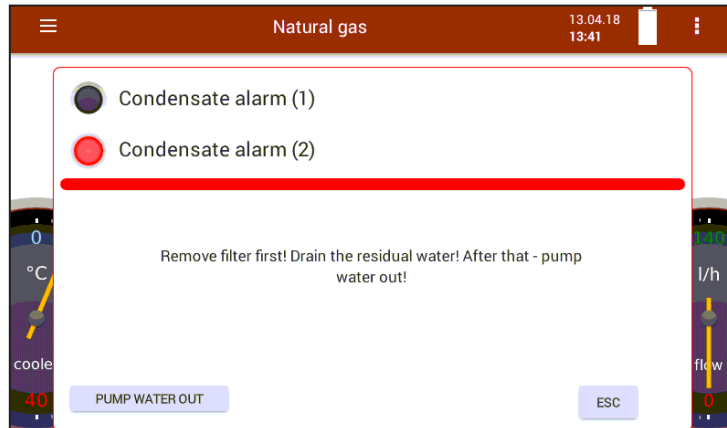

Possible causes	Repair
<p>Condensate or water has been detected behind the gas cooler stage. To protect the sensors the pump has been switched off..</p>	<ul style="list-style-type: none"> ▶ To continue operation it has to be ensured that no water will be fed to the sensors. ▶ Remove sample line. Check external filter on possible water content. Remove water ▶ Use the peristaltic pump to drain water. Therefore press the corresponding display button. ▶ Repeat if necessary. ▶ In a second step, if the proceeding steps removed all water possibly present in the gas cooler and hoses, the gas pump may be used to dry out remaining water droplets.

12.2 Insert a static IP-address

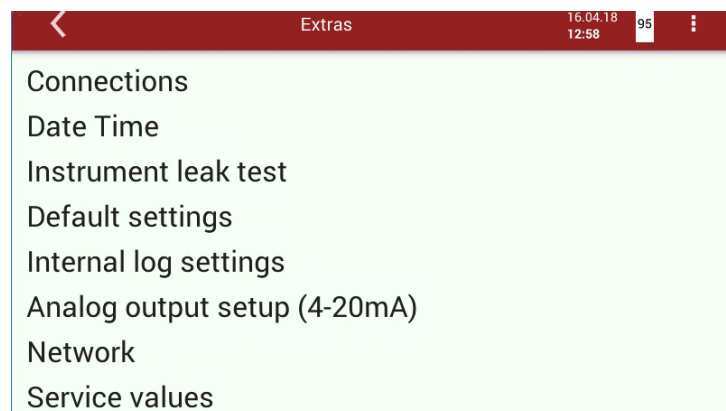

- ▶ Choose "network" in menu **Extras**.

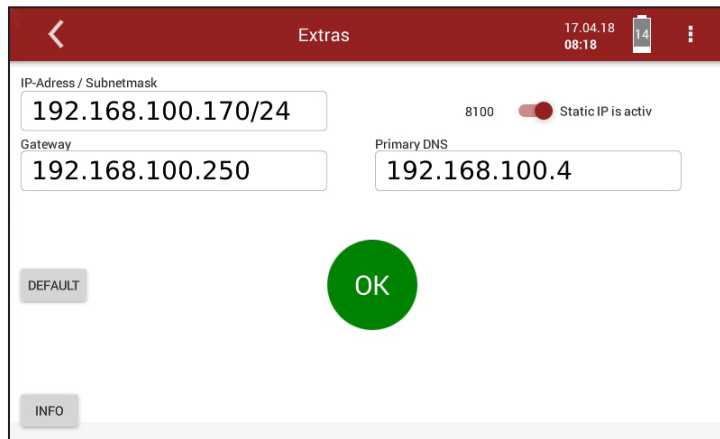

- ▶ Put the switch on "DHVF is active"
- ▶ Choose the desired IP address, subnet mask, standard gateway and preferred DNS server.
- ▶ Confirm with "OK".
 - ⇒ The modification will be active after restart.

The input of subnet mask occurs to following principle:

Hostanzahl No. of hosts	Subnetzmaske Subnet mask	32-Bit-Wert 32 bit value	Suffix
16.777.214	255.0.0.0	1111 1111 0000 0000 0000 0000 0000 0000	/8
:	:	:	:
1.048.574	255.240.0.0	1111 1111 1111 0000 0000 0000 0000 0000	/12
:	:	:	:
65.534	255.255.0.0	1111 1111 1111 1111 0000 0000 0000 0000	/16
:	:	:	:
16.382	255.255.192.0	1111 1111 1111 1111 1100 0000 0000 0000	/18
:	:	:	:
254	255.255.255.0	1111 1111 1111 1111 1111 1111 0000 0000	/24
:	:	:	:
2	255.255.255.252	1111 1111 1111 1111 1111 1111 1111 1100	/30

12.2.1 Settings for the software MRU4win

The PC program MRU4win can be used for a LAN connection of the analyzer.

- ▶ Connect the analyzer with the network.

Read the IP address

- ▶ Select the “display setting” in the main menu using the context key.

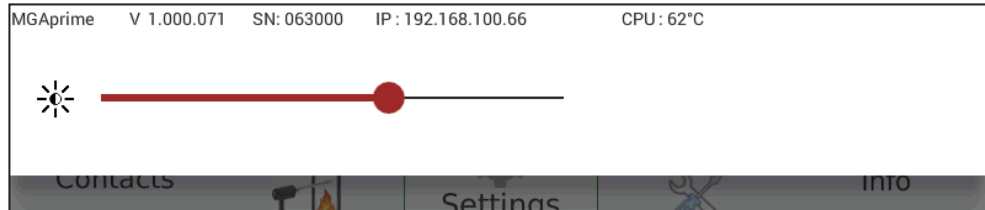

- ⇒ The IP address is shown at the top line.

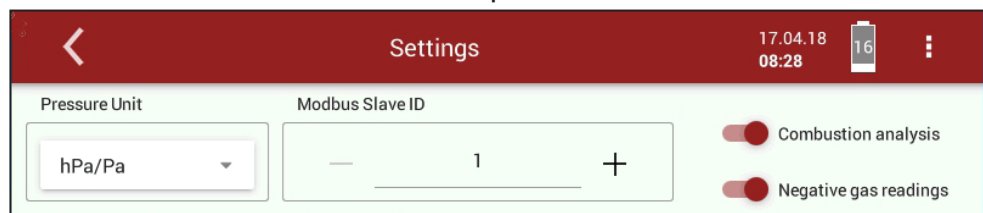

- ▶ Modbus slave ID set to 1.

Adjust MRU 4 Win to PC

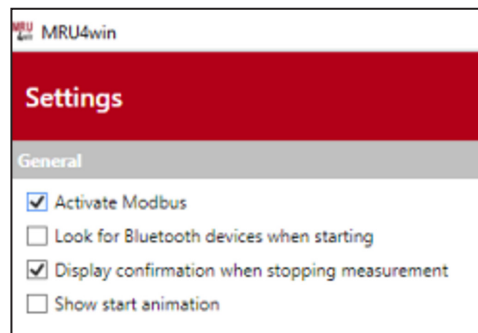

- ▶ The Modbus must be activated in the Setting menu
- ▶ „Create a Modbus Device“

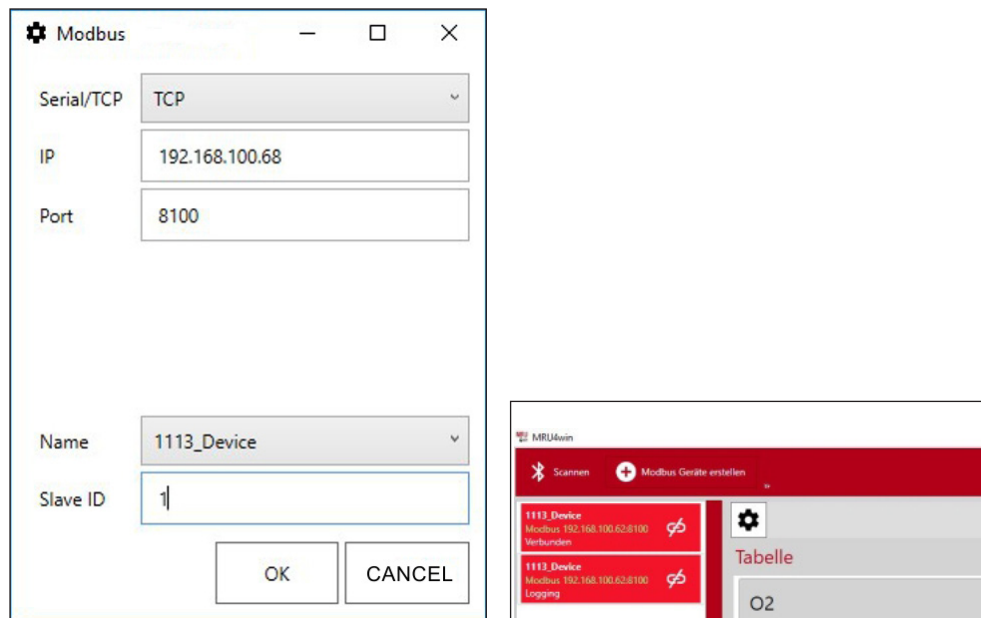

- ▶ The IP address of the analyzer must be inserted.
- ⇒ After these settings, the analyzer connect to the PC.

Info about the network

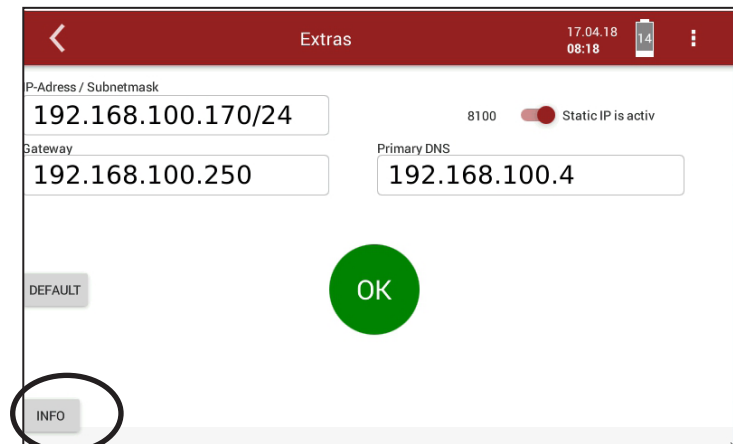

12.3 Spare parts

Part number	Spare part
56879A	PTFE Round filter
61158	Probe filter sintered metal 2 µm
61157	Probe filter sintered metal 20 µm
10825	Mineral wool filter element
59799	O-ring 16 x 1,5
61066	O-ring 12 x 2
61333	O-ring 10 x 2
60074	O-ring 8 x 2

13 Declaration of conformity

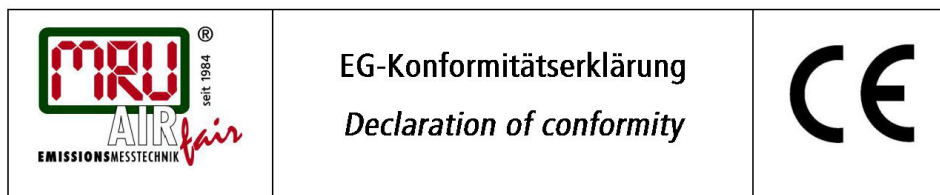

MRU Messgeräte für Rauchgase und Umweltschutz GmbH



Bevollmächtigte Person, für die Zusammenstellung der technischen Unterlagen
Person authorized to compile the technical documents

Name / name:	Dierk Ahrends
Funktion / function:	QM-Beauftragter / QM- Representative
Firmenname / company:	Messgeräte für Rauchgase und Umweltschutz GmbH
Straße / street:	Fuchshalde 8 + 12
Ort / city:	74172 Neckarsulm
Land / country:	Deutschland / Germany

Produkt/Product

Bezeichnung / designation:	Gasanalysator Gas analyser
Produktname / name:	MGAprime
Funktion / function:	Gasanalyse / gas analysis

Hiermit erklären wir, dass das oben beschriebene Produkt allen einschlägigen Bestimmungen entspricht, es erfüllt die Anforderungen der nachfolgend genannten Richtlinien und Normen:

We declare the conformity of the product with the applicable regulations listed below:

- EMV-Richtlinie / *EMV-directive* 2014/30/EU
- Niederspannungsrichtlinie / *low voltage directive* 2014/35/EU
- RoHS-Richtlinie / *RoHS directive* 2011/65/EU (RoHS II)

Neckarsulm, 26.03.2018



Erwin Hintz, Geschäftsführer / *Managing Director*