

FLUKE®

971

Temperature Humidity Meter

Users Manual

PN 2441047
September 2005 Rev.1, 5/06
© 2005-2006 Fluke Corporation, All rights reserved. Printed in Taiwan
All product names are trademarks of their respective companies.

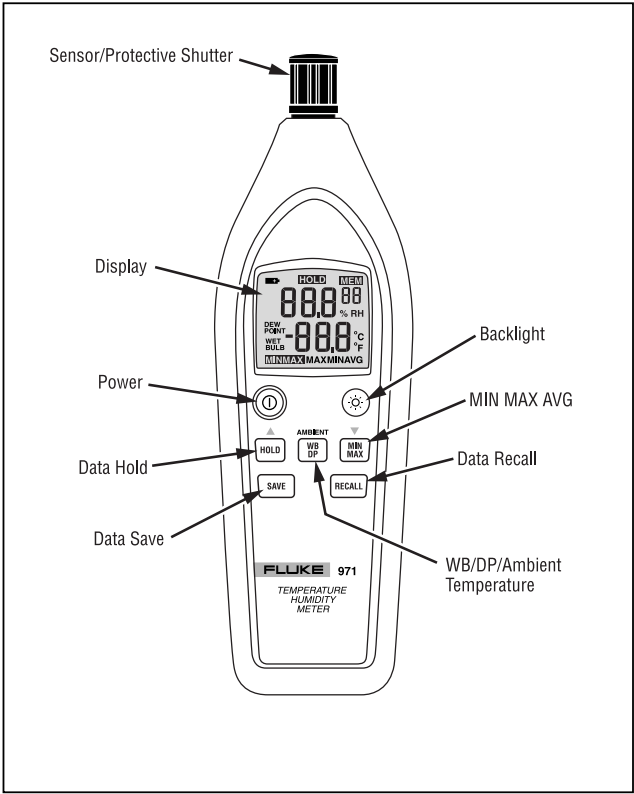

bdm003f.eps







Introduction

Caution

To extend sensor life, keep the sensor's protective shutter closed whenever the meter is not in use.

The Fluke Model 971 (hereafter referred to as “the Meter” is a battery powered meter that measures relative humidity and temperature. Through a few easy to use controls, the Meter displays three different temperature points of the air surrounding the meter's sensor: ambient, wet bulb, and dew point.

Electrical and Safety Symbols

	Important information. See manual		Low battery when shown in the display.
	Conforms to European Union requirements		Conforms to Australian standards.
	Conforms to Canadian standards		Power ON / OFF

Display

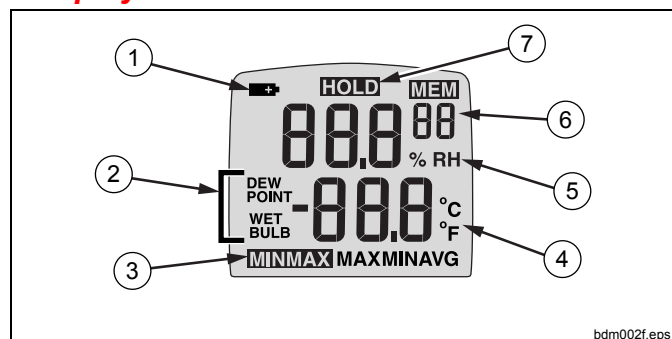

bdm002f.eps

No.	Symb ol	Meaning
1		Low battery.
2		Wet bulb or dew point temperature displayed.
3		Min Max Record enabled. Maximum, minimum, or average reading displayed.
4	°F, °C	Temperature measurement units.
5	% RH	Relative humidity measurement unit.
6		Displayed reading is from memory. Memory location number.
7		HOLD enabled. Display freezes present reading.

Operation



Note

When moving from one temperature/humidity extreme to another, allow time for the Meter to stabilize.



After opening the sensor's protective shutter, press  to turn on the Meter and start taking measurements.

Temperature readings are displayed in either the Celcius (°C) or Fahrenheit (°F) scale. To switch between °C and °F, remove the battery compartment door and position the temperature scale switch to the desired scale. See Figure 1.

Dew Point and Wet Bulb Temperature

The Meter displays ambient temperature when first turned on. To display dew point (DP) temperature, press  once. Press  again to switch to wet bulb (WB) temperature. Pressing  a third time returns the Meter to ambient temperature. The display indicates when dew point and wet bulb temperatures are selected.

HOLD



Pressing  causes the meter to freeze the displayed readings. It also causes the meter to stop taking measurements. **HOLD** is displayed when HOLD is enabled. To continue taking measurements, press  again.

Min Max Record

When enabled, Min Max Record stores a new measurement when it is either higher or lower than a previously stored maximum or minimum measurement. Press  to start Min Max Record. **MIN MAX** appears in the display to indicate Min Max Record mode is enabled.

Note

The temperature scale switch (°C/°F), Save, Recall, and Hold buttons, as well as the Automatic Power Off (APO) switch are all disabled when Min Max Record is enabled.

To view the stored Minimum, Maximum and Average readings, press  repeatedly to cycle through all three stored sets of measurements. You must select wet bulb, dew point, or ambient before reading their respective Min Max Avg values. The display indicates which stored set of readings is displayed. Pressing  a fourth time displays the present measurement.

To exit Min Max Record mode and resume normal operation, press and hold  for two seconds.

Saving and Recalling Measurements

The Meter stores up to 99 readings for later recall. Each memory location stores relative humidity as well as ambient, dew point and wet bulb temperatures.

Temperature
Operatio

Humidity Meter
n

Pressing **SAVE** saves the present readings to a memory location. **MEM** and the memory location number appear in the display to indicate the readings have been stored. Press **WB DP** to return the display to the present reading. After all 99 memory locations are filled, each subsequent save overwrites a memory location starting with the first.

To recall the readings from memory, press **RECALL**. If the memory location you are looking for is not already displayed, press **▲** or **▼** until the desired memory location is displayed. To return the Meter to normal operation, press **RECALL** for two seconds.

By default, relative humidity and ambient temperature are displayed when a memory location is recalled. Pressing **WB DP** cycles through the Wet Bulb, Dew Point, and Ambient temperatures stored in the memory location displayed.

To erase all 99 memory locations, simultaneously press **SAVE** and **RECALL** for five seconds.

Automatic Power Off

To save battery life, the Automatic Power Off (APO) feature can be used to turn the meter off after 20 minutes of no activity. To enable or disable the APO feature, remove the battery cover and position the APO switch to the desired position. See Figure 1.

Maintenance

Battery Replacement

Meter power is supplied by four 1.5 V (AAA size) batteries. When **+** appears in the display, replace the batteries as soon as possible. To replace the batteries:

1. Back out the screw at the top of the battery door and lift the door away from the Meter.
2. Remove the four AAA batteries from the compartment.
3. Replace with four new AAA batteries, observing proper polarity as depicted on the bottom of the battery compartment.
4. Replace the battery door and tighten the screw to lock it in place.

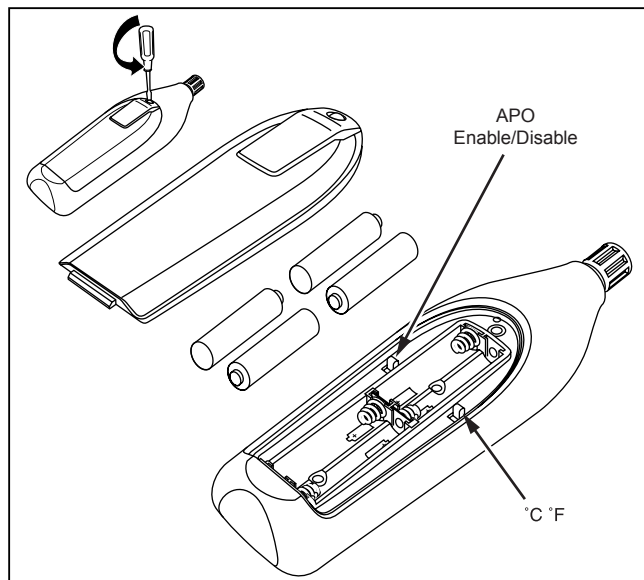

Figure 1. Battery Compartment

Cleaning

⚠ Caution

To avoid damage to the case, do NOT use abrasives or solvents for cleaning the meter.

Periodically wipe the case with Fluke Meter Cleaner or a damp cloth and detergent.

Specifications

Temperature

Range:	-20 to 60 °C (-4 to 140 °F)
Accuracy:	±0.5 °C on 0 to 45 °C ±1.0 °C on -20 to 0 °C, 45 to 60 °C ±1.0 °F on 32 to 113 °F ±2.0 °F on -4 to 32 °F, 113 to 140 °F
Resolution:	0.1 °C /°F
Update rate:	500 ms
Sensor type:	NTC

Relative Humidity

Range:	5 to 95 % RH
Accuracy:	±2.5 % RH (10 to 90 % RH) @23 °C (73.4 °F) ±5.0 % RH (<10, >90 % RH) @23 °C (73.4 °F)
Resolution:	0.1 % RH
Response time:	60 seconds max.
Sensor hysteresis:	±1 % RH with excursion of 90 % to 10 % to 90 %
Sensor type:	Electronic–capacitance polymer film
Temperature Coefficient:	0.1 x (specified accuracy)/°C (< 23 °C or > 23 °C)

Wet Bulb Temperature

Range:	-20 to 60 °C (-4 to 140 °F)
Dew Point Temperature Range:	-50 to 60 °C (-58 to 140 °F)

**Temperature
Specific**

**Humidity Meter
ations**

Memory:	99 data points
Power:	4 each AAA batteries, 24A, LR03
Battery Life:	200 hours
Environment	
Storage:	-20 to 60 °C at <80 % R.H. (Batteries removed)
Operating:	Temperature: -20 to 60 °C Humidity: 0 to 55 °C
Weight/Dimensions:	190 g with batteries 194 mm x 60 mm x 34 mm
Safety Approvals/ Certifications:	☑ Meets Australian requirements ☑ Meets CSA requirements ☑ Meets European requirements Meets EN61326-1, Schedule B Electromagnetic Emissions and Susceptibility

Specifications subject to change without notice

LIMITED WARRANTY AND LIMITATION OF LIABILITY

This Fluke product will be free from defects in material and workmanship for one year from the date of purchase. This warranty does not cover fuses, disposable batteries, or damage from accident, neglect, misuse, alteration, contamination, or abnormal conditions of operation or handling. Resellers are not authorized to extend any other warranty on Fluke's behalf. To obtain service during the warranty period, contact your nearest Fluke authorized service center to obtain return authorization information, then send the product to that Service Center with a description of the problem.

THIS WARRANTY IS YOUR ONLY REMEDY. NO OTHER WARRANTIES, SUCH AS FITNESS FOR A PARTICULAR PURPOSE, ARE EXPRESSED OR IMPLIED. FLUKE IS NOT LIABLE FOR ANY SPECIAL, INDIRECT, INCIDENTAL OR CONSEQUENTIAL DAMAGES OR LOSSES, ARISING FROM ANY CAUSE OR THEORY. Since some states or countries do not allow the exclusion or limitation of an implied warranty or of incidental or consequential damages, this limitation of liability may not apply to you.

11/99

10