

**CM4141
CM4142**

AC CLAMP METER

Instruction Manual



EN

Feb. 2019 Edition 1
CM4141A961-00 19-02H



Contents

Introduction.....	1
Notations	2
Verifying Package Contents	4
Options (sold separately).....	5
Usage Notes.....	6
1 Overview	11
1.1 Product Overview and Features.....	11
1.2 Part Names	12
2 Making Measurements	13
2.1 Inspection Before Measurement	13
2.2 Current Measurement	14
Manual Hold/Auto Hold.....	15
Switching the range.....	18
MAX value/MIN value/AVG value/PEAK value.....	19
Filter Function.....	20
Rush current (AC INRUSH).....	21
2.3 Other Measurement Functions.....	22
CM4141A961-00	i



Contents

2.4	Backlight/Auto Power Save (APS).....	26
2.5	Power-on Option Table.....	27
2.6	Bluetooth® Communications (only for model CM4142)	29
3	Specifications	35
3.1	General Specifications	35
3.2	Input specifications/Measurement specifications	37
3.3	Accuracy Table	44
4	Repairs, Inspections, and Cleaning	59
4.1	Troubleshooting.....	59
4.2	Error display	61
4.3	Insert/Replace Batteries	62
4.4	Cleaning	64
	Index	65
	Warranty Certificate	

Introduction

Thank you for purchasing the Hioki CM4141, CM4142 AC Clamp Meter. To obtain maximum performance from the instrument over the long term, be sure to read this manual carefully and keep it handy for future reference.

Read the separate document "Operating Precautions" carefully before using the instrument.

Target audience

This manual has been written for use by individuals who use the product in question or who teach others to do so. It is assumed that the reader possesses basic electrical knowledge (equivalent to that of someone who graduated from the electrical program at a technical high school).

Trademark





- Bluetooth® is a registered trademark of Bluetooth SIG, Inc.(USA). The trademark is used by HIOKI E.E. CORPORATION under license.
- Android, Google Play, and Google Chrome are trademarks of Google, Inc.
- IOS is a registered trademark of Cisco Systems, Inc. and/or its affiliates in the United States and certain other countries.
- iPhone, iPad, iPad mini™, iPad Pro, and iPod touch are trademarks of Apple Inc.
- The App Store is a service mark of Apple Inc.
- Any other products and company names are generally either trade names, registered trademarks or trademarks of respective companies.

Notations



Notations

Concerning Safety

In this document, the risk seriousness and the hazard levels are classified as follows.

 DANGER	Indicates an imminently hazardous situation that will result in death or serious injury to the operator.	IMPORTANT	Indicates information related to the operation of the instrument or maintenance tasks with which the operators must be fully familiar.
 WARNING	Indicates a potentially hazardous situation that may result in death or serious injury to the operator.		Indicates prohibited actions.
 CAUTION	Indicates a potentially hazardous situation that may result in minor or moderate injury to the operator or damage to the instrument or malfunction.		Indicates an action that must be performed.

Symbols Affixed to the Instrument

	Indicates cautions and hazards. Refer to the "Usage Notes" (p.6) section of the instruction manual and the included "Operating Precautions" for more information.
	Indicates that the instrument may be connected to or disconnected from a live conductor.



Screen display

The instrument screen displays the alphanumeric characters as follows.

A	B	C	D	E	F	G	H	I	J	K	L	M	N	O	P	Q	R	S	T	U	V	W	X	Y	Z
R	b	C	d	E	F	G	H	I	J	K	L	M	N	O	P	Q	R	S	T	U	V	W	X	Y	Z
1	2	3	4	5	6	7	8	9	0																
1	2	3	4	5	6	7	8	9	0																

A different display is used in the case below.

OPEN : Wiring break detected

Other

	Indicates a buzzer sound (either intermittent or continuous).
--	---

Accuracy

We define measurement tolerances in terms of f.s. (full scale), rdg. (reading) and dgt. (digit) values with the following meanings:

f.s.	(maximum display value/range) The maximum displayable value. This is usually the name of the currently selected range.
rdg.	(displayed value) The value currently being measured and displayed on the measuring instrument.
dgt.	(resolution) The smallest displayable unit on a digital measuring instrument, i.e., the input value that causes the digital display to show a "1" as the least-significant digit.

Verifying Package Contents

Verifying Package Contents

- Model CM4141 or CM4142 AC Clamp Meter
- Model L9207-10 Test Lead

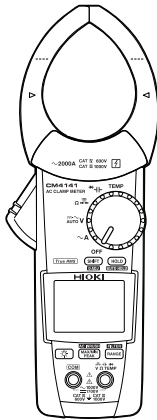

- Model C0203 Carrying Case



- LR03 Alkaline battery ×2



- Instruction Manual*



- Operating Precautions (0990A907)



- Precautions Concerning Use of Equipment that Emits Radio Waves (only for model CM4142)



Options (sold separately)

Options (sold separately)

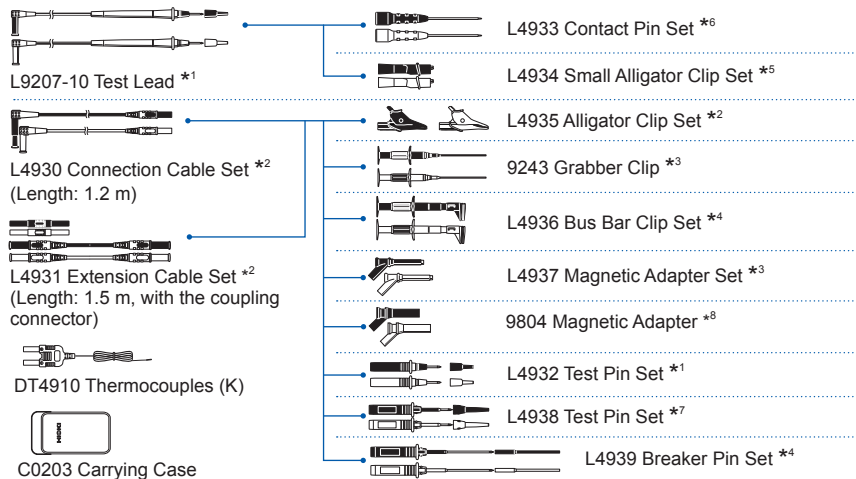

*1: CAT IV 600 V/ CAT III 1000 V/ CAT II 1000 V
*2: CAT IV 600 V/ CAT III 1000 V
*3: CAT III 1000 V
*4: CAT III 600 V

*5: CAT III 300 V/ CAT II 600 V
*6: 33 V AC/ 70 V DC
*7: CAT III 600 V/ CAT II 600 V
*8: CAT IV 1000 V

Usage Notes

Usage Notes

Follow these precautions to ensure safe operation and to obtain the full benefits of the various functions. Read the separate document “Operating Precautions” carefully before using the instrument. Ensure that your use of the product falls within the specifications not only of the instrument itself, but also of any accessories, options, batteries, and other equipment being used.

DANGER



- To prevent an electric shock, do not touch any areas beyond the barrier while the instrument is in use.
See: “Part Names” (p.12)
- The maximum measurement current varies with the frequency, and the current that can be measured continuously is limited. Operating the instrument at less than this limitation is referred to as derating. Do not measure currents in excess of the derating curve. Doing so may result in instrument damage or malfunction, a fire, or burn due to sensor heating.
- Never apply a voltage to the instrument when the resistance, continuity check, diode check, capacitance, or temperature functions are selected. Damage to the instrument can cause bodily injury. To avoid electrical accidents, turn off the circuit before measuring it.

 **DANGER**

- To prevent an electric shock, confirm that the white portion (insulation layer) inside the cable is not exposed. If a color inside the cable is exposed, do not use the cable.

 **WARNING**

Do not allow the instrument to get wet, and do not take measurements with wet hands. This may cause an electric shock. (This precaution does not apply to insulated conductors.)



To prevent an electric shock, do not exceed the lower of the ratings shown on the instrument and test leads.

 **CAUTION**

Do not place any foreign object between the jaws or any insert foreign object into the gap of the sensor head. Doing so may worsen the performance of the sensor or the opening-closing operation of the sensor head.

Usage Notes

 **CAUTION**



Avoid dropping or jarring the instrument, which could damage the jaw, adversely affecting measurement.

IMPORTANT



Clamp the instrument around only one conductor. The instrument will not be able to make a measurement if you clamp it around two or more wires together, regardless of whether they are part of a single-phase or three-phase circuit.

Test Lead

 **WARNING**

To prevent an electric shock, when measuring the voltage of a power line use a test lead that satisfies the following criteria:

- Conforms to safety standards IEC61010 or EN61010
- Measurement category III or IV
- Its rated voltage is higher than the voltage to be measured



The optional test leads provided for the instrument conform to the safety standard EN61010. Use a test lead in accordance with its defined measurement category and rated voltage.

- To prevent a short-circuit accident, be sure to use the test leads with the sleeves attached when performing measurements in the CAT III and CAT IV measurement categories.
- If the sleeves are removed during measurement, stop the measurement.

 **CAUTION**

The cable is hardened in freezing temperatures. Do not bend or pull it to avoid tearing its shield or cutting cable.

Usage Notes

Model L4937, 9804 Magnetic Adapter Set (optional)

 **DANGER**



Persons wearing electronic medical devices such as a pacemaker should not use the Magnetic Adapter Set. Such persons should avoid even proximity to the Magnetic Adapter Set, as it may be dangerous. Medical device operation could be compromised, presenting a hazard to human life.

 **CAUTION**



- Do not subject the Magnetic Adapter Set to mechanical shock, for example, due to dropping it. Shock can cause it to be chipped or cracked.
- Do not use the Magnetic Adapter Set in locations where it may be exposed to rainwater, dust, or condensation. In those conditions, the Magnetic Adapter Set may be decomposed or deteriorated. The magnet adhesion may be diminished. In such case, the instrument may not be hung in place and may fall.
- Do not bring the Magnetic Adapter Set near magnetic storage device such as floppy disks, magnetic cards, pre-paid cards, or magnetized tickets. Doing so may corrupt and may render them unusable. Furthermore, if the Magnetic Adapter Set is brought near precision electronic equipment such as PCs, TV screens, or electronic wrist watches, they may fail.





1 Overview

1.1 Product Overview and Features

1

This instrument is a clamp meter that can perform true RMS measurement of current simply by clamping it around a circuit. In addition to current, it provides voltage measurement, frequency measurement, rush current measurement, resistance measurement, diode measurement, capacitance measurement, and temperature measurement. Model CM4142 also provide Bluetooth® communications functionality, allowing measurement data to be monitored and logged from a mobile device.

Measurement function list

TEMP	Temperature
	Capacitance, diode
	Continuity check, resistance
 AUTO V	AUTO V, AC voltage, DC voltage, AC+DC voltage
 ~ A	AC current

Overview

1.2 Part Names

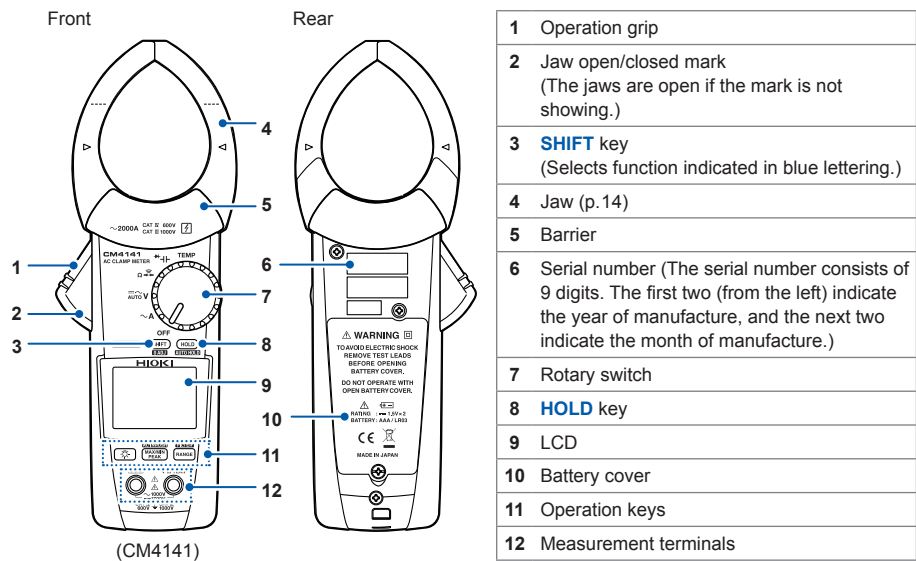

12

2 Making Measurements

2.1 Inspection Before Measurement

Check if there is any damage to the instrument occurred during storage or shipping and verify that instrument operates normally before using it. If you find any damage, contact your authorized Hioki distributor or reseller.

2

Check item	
<input type="checkbox"/> The battery cover is closed and its screw has been securely tightened.	<input type="checkbox"/> There is no damage to the test lead insulation, and neither the white sheathing nor metal conductor inside the wire are exposed.
<input type="checkbox"/> There is no foreign matter on the measurement terminals. (p. 12)	<input type="checkbox"/> The instrument is neither damaged nor cracked.
<input type="checkbox"/> The test leads are not broken.	<input type="checkbox"/> No indicators are missing.

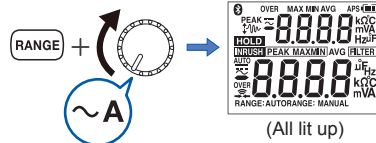
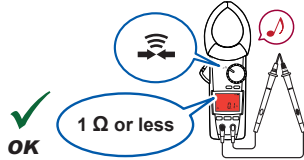

2.2 Current Measurement

- 1** Turn the rotary switch.



- 2** Clamp the instrument around a conductor.
e.g.: 3P4W (3-phase, 4-wire) circuit breaker (AC current measurement)

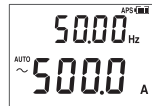
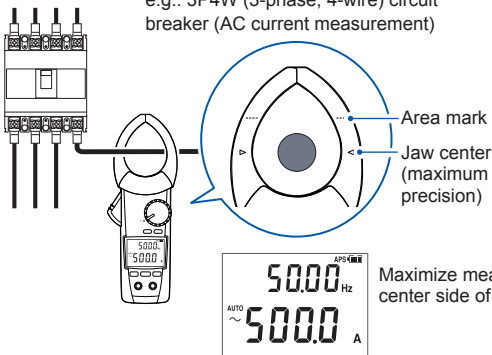

Maximize measurement precision by positioning the wire on the center side of the area mark.



~ + Hz ↔ Hz
(AC A) (Frequency) (Frequency)

Frequency detection range of AC current

3 A or more	(60.00 A range)
30 A or more	(600.0 A range)
200 A or more	(2000 A range)

Range (p.18)

Default setting is auto range.
Press the **RANGE** key to switch to manual range.

Manual Hold/Auto Hold

Manual hold

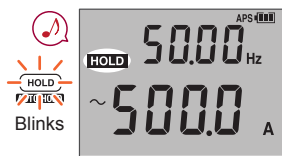

Measured value retains.

Pressing the **HOLD** key again cancels the measured value hold function.

Auto hold

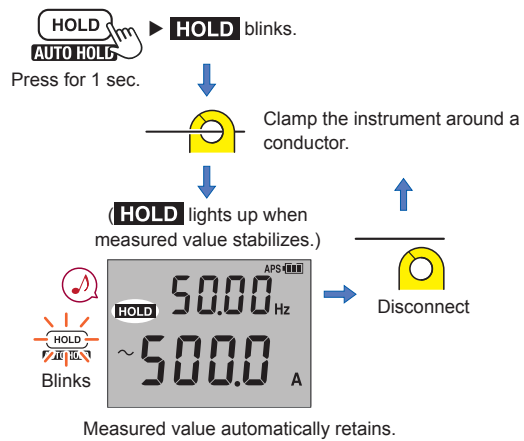

2

Pressing the **HOLD** key for 1 sec. cancels the auto hold function.

Current Measurement

Auto hold conditions

Display value updates are stopped when the following two conditions are satisfied:

- When the measured value exceeds the threshold value described in the table in the next page. (voltage, current). When the measured value is less than the threshold value described in the table in the next page. (resistance, continuity, diode)
- When the range over which the measured value is fluctuating stabilizes within the fluctuation range described in the table in the next page.

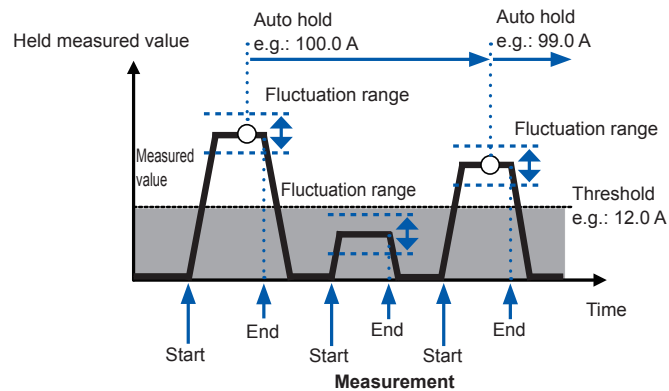

If the measured value falls below the threshold value (voltage, current) or exceeds the threshold value (resistance, continuity, diode) after display value updates are stopped, the display value update is restarted. Display value updates will stop if the two conditions are satisfied once again.

Current Measurement

Measurement function	Fluctuation range	Threshold value
AC current	60.00 A range: within 400 counts 600.0 A range: within 400 counts 2000 A range: within 40 counts	60.00 A range: 100 counts 600.0 A range: 120 counts 2000 A range: 40 counts
AUTO V AC voltage DC voltage AC+DC voltage	6.000 V/60.00 V/600.0 V range: within 120 within 1000 V range: within 20 counts 1500 V range: within 30 counts	6.000 V/60.00 V/600.0 V range: 120 counts 1000 V range: 20 counts 1500 V range: 30 counts
Resistance Continuity	600.0 Ω /6.000 k Ω /60.00 k Ω / 600.0 k Ω range: within 100 counts	600.0 Ω /6.000 k Ω /60.00 k Ω / 600.0 k Ω range: 4900 counts
Diode	1.800 V range: within 40 counts	1.800 V range: 1460 counts

2

The auto hold function only operates for the above measurement functions.

Current Measurement

Switching the range

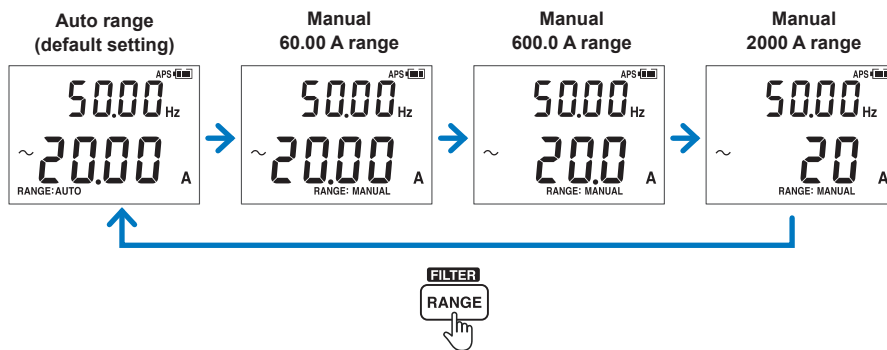

MAX value/MIN value/AVG value/PEAK value

1 Clamp the instrument around a conductor. 

2  See: "Switching the range" (p.18)
In auto-range mode, the instrument will be automatically set to the 2000 A range.

3  **MAX → MIN → AVG → PEAK MAX → PEAK MIN**
 Press for 1 sec. **Cancel**

4  Measured value retains.

The instrument performs true RMS measurement.

"AVG" indicates the average of all measured values.

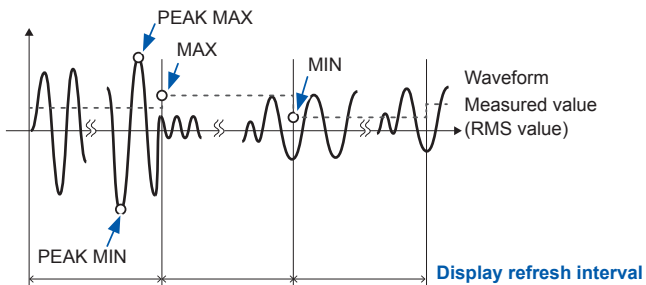

2

Current Measurement

Filter Function

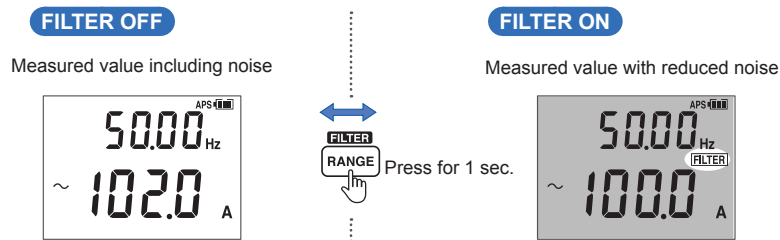

Frequency characteristics when using the filter function (100 A input)

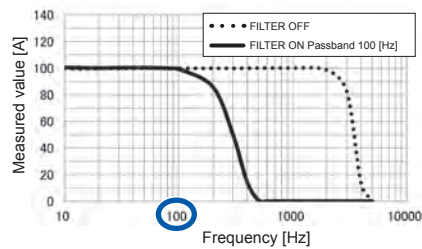

Turn off the filter function when performing measurement of power supply frequencies in excess of 100 Hz, for example on an aircraft or ship.

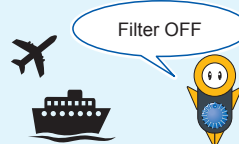

Rush current (AC INRUSH)

1 Turn off the motor.

2 Turn the rotary switch.



3 Clamp the instrument around a conductor.

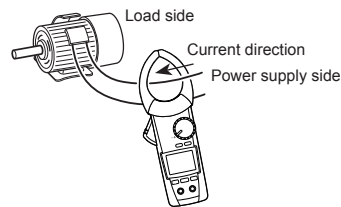

4 Set the range.

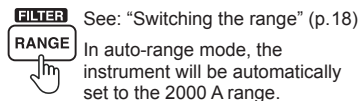

5 Press for 1 sec.



6 Turn on the motor.

The instrument can measure AC rush current. Rush current containing a DC component cannot be measured accurately.

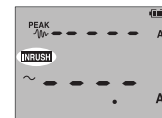

(Rush current occurrence)

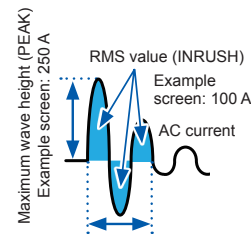

Trigger level
 ±2 A peak (60.00 A range)
 ±10 A peak (600.0 A range)
 ±100 A peak (2000 A range)

Interval during which rush current occurs
 (Dozens to hundreds of milliseconds in duration)

2

2.3 Other Measurement Functions

Voltage

e.g.: commercial power supply (AC voltage measurement)

1 AUTO V

2 Red Black

3 SHIFT/ADJ Switch the range ▶ FILTER RANGE

- AUTO (AUTO AC/DC)
- ~ (AC V)
- ≡ (DC V)
- ~≡ (AC+DC V)
- Hz (Frequency)

No overvoltage
NO 5000 Hz
NO 1000 V
(Red flash)

Do not touch.
NO

DC voltage polarity detection function (p.27)
If the measured value is negative, the buzzer will sound, and the display will turn red (threshold: -10 V).

Other Measurement Functions

Continuity Check

1 Zero adjustment

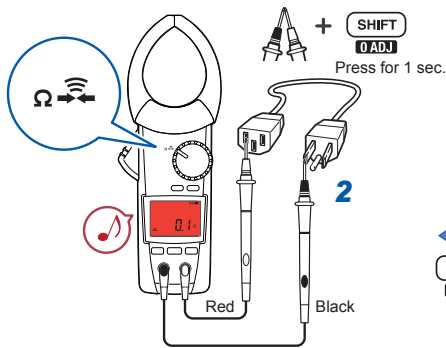

+ SHIFT
0 ADJ
Press for 1 sec.



(Red display)

Resistance

1 Zero adjustment

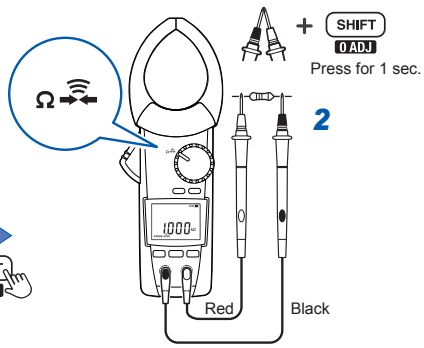

+ SHIFT
0 ADJ
Press for 1 sec.

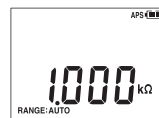

2

Other Measurement Functions

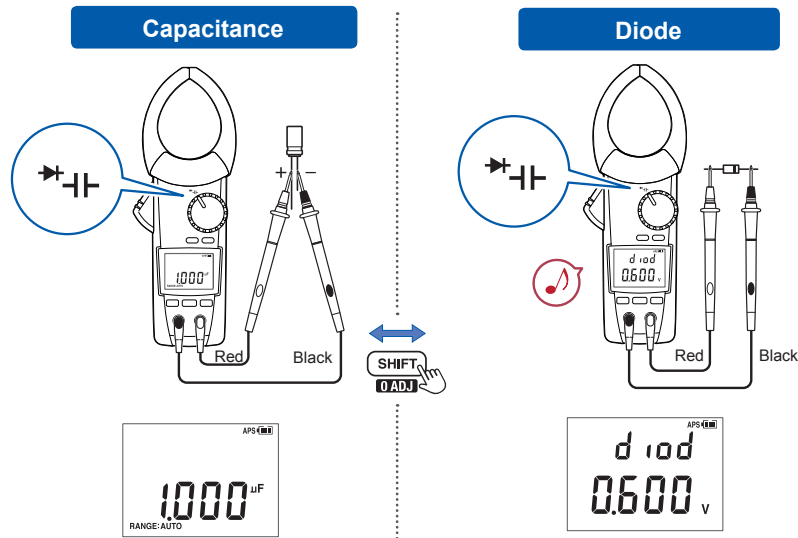

Buzzer sound
Intermittent sound: during forward connection (0.15 V to 1.8 V),
backlight off
Continuous sound: during forward connection (less than 0.15 V),
red backlight on

Temperature

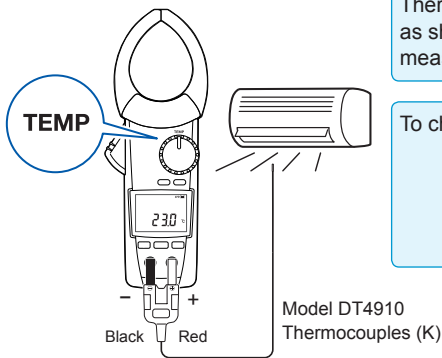

IMPORTANT
Thermocouples (K) experience a phenomenon known as short-range ordering that may prevent accurate measurement in the range of 250°C to 600°C.

To change the temperature display unit: p.28

TEMP °C ↔ °F

2



OPEN : DT4910 is broken.

Backlight/Auto Power Save (APS)

2.4 Backlight/Auto Power Save (APS)

Backlight

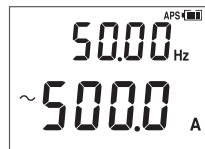

Backlight OFF

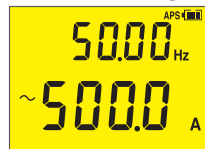
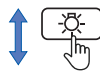

Backlight ON
Automatically switched off when the instrument is not in use for 40 sec.
(Automatic backlight deactivation ON)
Cancellation method: p.27

Auto Power Save (APS)

(Always on)

Cancellation method: p.27

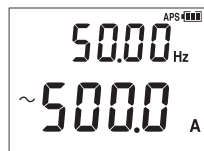

No operation for 15 min.

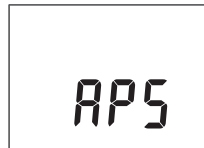

No operation for 45 min.







The instrument is automatically turned off.

To restart the instrument, briefly set the rotary switch to "OFF."

You can turn the display back on by pressing a key or by turning the rotary switch.







2.5 Power-on Option Table

+  Move the rotary switch from the "OFF" position to any of the test mode positions while pressing an operation key.

Setting	Operating instruction	Factory setting	Setting retained?
Canceling the auto power save (APS) function (OFF)	HOLD + 	ON	No (Set each time)
DC voltage polarity detection function (ON/OFF)	SHIFT + 	OFF	Yes
Displaying all indicators (Version of software/Model number/Serial number)	RANGE + 	-	-
Buzzer sound (ON/OFF)	MAX/MIN PEAK + 	ON	Yes
Automatic backlight deactivation (ON/OFF)	 + 	ON	Yes

2

Power-on Option Table

Setting	Operating instruction	Factory setting	Setting retained?
Switching the temperature unit	<p>  +  +  </p> <p>↓</p> <p>  +  </p> <p>Press for 1 sec.</p> <p>↓</p> <p>To change the temperature unit: </p> <p>↓</p> <p>To save the setting: </p> <p>Press for 1 sec.</p>	°C	Yes

Bluetooth® Communications (only for model CM4142)

2.6 Bluetooth® Communications (only for model CM4142)

The CM4142 supports Bluetooth (Bluetooth low energy). When the Bluetooth function is enabled, you can review measurement data and create measurement reports on mobile devices (iPhone, iPad, iPad mini™, iPad Pro, iPod touch, and Android™ devices). For more information about this functionality, see the [Help](#) function in the application software GENNECT Cross.

- 1 Install the GENNECT Cross on your mobile device. (p.30)



- 2 Enable the Bluetooth function on the CM4142. (p.31)

- 3 Launch the GENNECT Cross and pair it with the CM4142. (p.32)

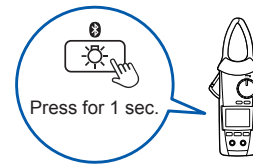

- 4 Select the **General Measurement**, **Logging (Recording)**, or **Waveform/FFT** function. (p.33)



Bluetooth® Communications (only for model CM4142)

Installing the application software GENNECT Cross

Search for “GENNECT Cross” on the App Store from your iPhone, iPad or other Apple device, or on Google Play™ from your Android device. Then download and install the GENNECT Cross. You will need an Apple ID to download the app on the App Store, or a Google account to download the app on Google Play. For more information about how to register an account, contact the store at which you purchased your device.



- Because the CM4142 emit radio waves, use in a country or region where they have not been approved may be subject to fines or other penalties as a violation of applicable laws or regulations. For more information, see the attached “Precautions Concerning Use of Equipment that Emits Radio Waves” or go to our website.
- The CM4142 availability is limited to certain countries. For more information, contact your authorized Hioki distributor or reseller.
- The distance over which data can be sent and received using Bluetooth varies greatly depending on whether there are any obstructions between the paired instruments (for example, walls, metal barriers, etc.) and on the distance between the instrument and the floor (or ground). To ensure stable measurement, verify adequate signal strength.
- Although this application software is provided free of charge, downloading or using the application software may incur Internet connection charges. Such charges are the sole responsibility of the user.
- This application software is not guaranteed to operate on all mobile devices.

Bluetooth® Communications (only for model CM4142)

Turning on the Bluetooth function

Bluetooth function OFF

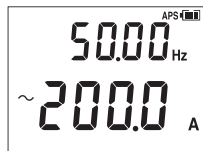

Press for 1 sec.

Bluetooth function ON

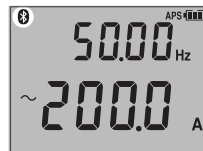

2

Bluetooth icon lights up: Bluetooth function ON

Bluetooth icon flashes: Sending/receiving data

Bluetooth® Communications (only for model CM4142)

Pairing the app with the CM4142



- When the app is launched for the first time (before being paired with any instrument), the **Instrument Settings** screen will be displayed.
- While the mobile device is displaying the **Instrument Settings** screen, simply move it close to a CM4142 to automatically pair it with the instrument (the app can be paired with up to 8 instruments).
- Allow about 5 to 30 seconds for the CM4142 to pair with the app after being turned on. If the instrument fails to pair within 1 minute, relaunch GENNECT Cross and cycle the instrument's power.

32

Bluetooth® Communications (only for model CM4142)

Making measurements with the Bluetooth function

Select the **General Measurement**, **Logging (Recording)**, or **Waveform/FFT** function on the **Home** screen. For more information about each function, see the **Help** function in the GENNECT Cross.

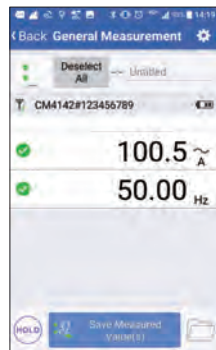

General Measurement

Saves measured values from multiple channels

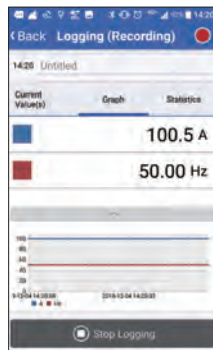

Logging (Recording)

Simple logging (up to 24 hours)



Waveform/FFT

Simple oscilloscope (voltage/current)

2

3

Specifications

3.1 General Specifications

Operating environment	Indoors, pollution degree 2, altitude up to 2000 m (6562 ft.)
Operating temperature and humidity	-25°C to 65°C (-13°F to 149°F), 90% RH or less (no condensation)
Storage temperature and humidity	-30°C to 70°C (-22°F to 158°F), 90% RH or less (no condensation, when batteries are removed)
Dustproof and waterproof	IP20 (Measuring voltage or current in a hazardous live conductor while completely dry) IP50 (Measuring resistance or current in an insulated conductor while completely dry, or during storage) However, the instrument's handle provides IP54-equivalent dust and water protection when the instrument is not making a measurement.
Standards	Safety EN 61010 EMC EN 61326
Power supply	LR03 alkaline battery ×2 Rated supply voltage: 1.5 V DC ×2
Continuous operating time	Approx. 48 hours (Bluetooth communication OFF) Approx. 24 hours (Bluetooth communication ON) Other conditions: 100 AAC measurement, LCD backlight OFF, at 23°C (73.4°F), for reference

3

General Specifications

Interface (only for CM4142)	Bluetooth 4.0 LE  Bluetooth® (p.29)
Dimensions	Approx. 65W × 247H × 35D mm (2.56"W × 9.72"H × 1.38"D) (excluding protruding parts, operation grip, and jaw)
Jaw dimensions	Approx. 82W × 11D mm (3.23"W × 0.43"D) (The D figure indicates the depth for the first 44 mm of each jaw from its tip.)
Jaw cross-sectional minimum dimension	Approx. 11 mm (0.43") (Indicates the depth for the first 44 mm of each jaw from its tip.)
Maximum measurable conductor diameter	φ55 mm (2.17")
Mass	Approx. 300 g (10.6 oz.) (including batteries)
Product warranty period	3 years Number of jaw open/close cycles: 30,000
Accessories	See: "Verifying Package Contents" (p.4)
Options	See: "Options (sold separately)" (p.5)

3.2 Input specifications/Measurement specifications

(1) Basic Specifications

Measurement range	See "3.3 Accuracy Table" (p.44)	
Maximum input current	As per frequency derating (p.38)	
Maximum input voltage	to terminal	600 V AC (Measurement category IV) 1000 V AC (Measurement category III) 1000 V AC (up to 1 kHz) 1700 V DC
	to earth	600 V AC (Measurement category IV) 1000 V AC (Measurement category III) Anticipated transient overvoltage: 8000 V
Measurement method	True RMS measurement	
Measurement terminals	COM terminal and V terminal	
Coupling type	AC current/current frequency/ AC INRUSH/AC voltage*1/ voltage frequency	AC coupling
	Measurement items other than the above	DC coupling

Input specifications/Measurement specifications

Display update rate *2	AC current/AUTO V/AC voltage/ DC voltage/AC+DC voltage	5 times/sec.
	Current frequency/ voltage frequency/capacitance	0.5 times to 5 times/sec. (varies depending on the measurement value.)
	Temperature (Thermocouples [K])	1 time/sec.

*1: Does not apply to AC detection in AUTO V mode or to the AC component when DC+AC voltage are mixed.

*2: Does not include range change time.

(2) Current measurement specifications

Frequency derating	Lower of 3000 A AC or 6×10^6 A · Hz (continuous, design value)		
Zero-display range	AC current	5 counts or less	
Crest factor	AC current/ AC INRUSH	60.00 A range	3 (5000 counts or less)
		600.0 A range	2.5 (more than 5000 counts, 6000 counts or less)
		2000 A range	1.5 (2000 counts or less)
Frequency detection input level	AC current/ current frequency	60.00 A range	300 counts or more
		600.0 A range	300 counts or more
		2000 A range	200 counts or more

Input specifications/Measurement specifications

AC INRUSH Trigger level	AC INRUSH	60.00 A range	+2.0 A _{PEAK} or more, or -2.0 A _{PEAK} or less
		600.0 A range	+10 A _{PEAK} or more, or -10 A _{PEAK} or less
		2000 A range	+100 A _{PEAK} or more, or -100 A _{PEAK} or less
Peak detection time width	AC current/ AC INRUSH	1 ms or more (when filter is off)	

(3) Voltage measurement specifications

3

Overload protection	1870 V DC Lower of 1100 V AC or 2×10^7 V · Hz (Applied continuously for up to 1 min.)		
Input impedance	See "3.3 Accuracy Table" (p.44)		
Zero-display range	AUTO V/AC voltage/ AC+DC voltage	5 counts or less	
Crest factor	AUTO V/AC voltage/ AC+DC voltage	6.000 V range	3 (4000 counts or less)
		60.00 V range	2 (more than 4000 counts, 6000 counts or less)
		600.0 V range	
		1000 V range	2 (850 counts or less) 1.7 (more than 850 counts, 1000 counts or less)

Input specifications/Measurement specifications

Frequency detection input level	AUTO V/AC voltage	10% or more of each range f.s.
CMRR * ¹	AC voltage/AC+DC voltage	-60 dB or more
	DC voltage	-100 dB or more
NMRR * ²	DC voltage	-60 dB or more
Peak detection time width	AC voltage	1 ms or more (when filter is off)

*1: Defined for 1 kΩ unbalance, 0 Hz/50 Hz/60 Hz input

*2: Defined for 50 Hz/60 Hz input

(4) Other Measurement Specifications

Overload protection	1700 V DC Lower of 1000 V AC or 2×10^7 V · Hz (Applied continuously for up to 1 min.)
Overload current	At steady state: 30 mA or less At transient state: 1.5 A or less
Measurement current/charging current	See "3.3 Accuracy Table" (p.44)

Input specifications/Measurement specifications

Open terminal voltage	2.0 V DC or less	
Continuity on threshold	Continuity check	25 $\Omega \pm 10 \Omega$ (continuous buzzer sound, red warning backlight lights up)
Continuity off threshold	Continuity check	245 $\Omega \pm 10 \Omega$
Maximum capacity load	Resistance	10 mF
Maximum inductive load	Resistance	10 H
Instrument reference contact temperature correction stabilization time	Temperature (Thermocouples [K])	Up to 120 minutes (Reference: For an instrument at 23°C [73°F] placed in a 65°C [149°F] environment: 60 minutes)

3

Input specifications/Measurement specifications

(5) Accuracy specifications

Conditions of guaranteed accuracy	Guaranteed accuracy period	1 year (accuracy shown in accuracy table) 3 years (accuracy shown in accuracy table × 1.5) (reference values)
	Guaranteed accuracy period after adjustment made by Hioki	1 year
	Guaranteed accuracy for temperature and humidity	23°C±5°C (73°F±9°F), 90% RH or less (no condensation)
	Continuity check/resistance: after zero adjustment has been performed Use model DT4910 for temperature (Thermocouples [K])	
Conditions of accuracy input	Sine wave input	
Measurement accuracy	See "3.3 Accuracy Table" (p.44)	
Temperature coefficient	Add "measurement accuracy × 0.1/°C" (excluding 23°C±5°C [73°F±9°F]).	

Input specifications/Measurement specifications

Effects of conductor position *1	Cable diameter	Measurement area	Accuracy	Measurement area figure
	CV8 mm ² (Finished outer diameter: 8.6 mm)	Area A	Area B	Within ±3.0% rdg. Within ±7.0% rdg.
CV38 mm ² (Finished outer diameter: 13 mm)	Area A	Area B	Within ±2.0% rdg. Within ±5.0% rdg.	
Effect of radiated radio-frequency electromagnetic field	Add ±2% rdg. at 10 V/m.			

3

*1: At 100 A, 55 Hz measurements around the jaw's center-point reference

Accuracy Table

3.3 Accuracy Table

(1) AC current

Measurement value/MAX/MIN/AVE (rms)

Range (Auto-range threshold)	Accuracy guarantee range (Resolution)	Accuracy guarantee frequency range	Measurement accuracy	
			Filter OFF	Filter ON* ¹
60.00 A (more than 6000 counts)	1.00 A to 60.00 A (0.01 A)	45 Hz ≤ f ≤ 66 Hz	±1.5% rdg.±0.08 A	±2.0% rdg.±0.08 A
		30 Hz ≤ f < 45 Hz,	±2.0% rdg.±0.10 A	±2.5% rdg.±0.10 A
		66 Hz < f ≤ 1 kHz		
600.0 A (more than 6000 counts/ less than 540 counts)	1.0 A to 600.0 A (0.1 A)	45 Hz ≤ f ≤ 66 Hz	±1.5% rdg.±0.3 A	±2.0% rdg.±0.3 A
		30 Hz ≤ f < 45 Hz,	±2.0% rdg.±0.5 A	±2.5% rdg.±0.5 A
		66 Hz < f ≤ 1 kHz		
2000 A (less than 540 counts)	10 A to 2000 A (1 A)	45 Hz ≤ f ≤ 66 Hz	±1.5% rdg.±3 A	±2.0% rdg.±3 A
		30 Hz ≤ f < 45 Hz,	±2.0% rdg.±5 A	±2.5% rdg.±5 A
		66 Hz < f ≤ 1 kHz* ²		

*1: Accuracy not defined beyond 66 Hz.

*2: Design values apply beyond 6×10^5 A · Hz.

Accuracy Table

PEAK MAX/PEAK MIN (Zero to Peak)

Range	Accuracy guarantee range (Resolution)	Accuracy guarantee frequency range	Measurement accuracy
60.00 A	±1.0 A to ±150.0 A (0.1 A)	45 Hz ≤ f ≤ 66 Hz	±1.5% rdg.±0.8 A
		30 Hz ≤ f < 45 Hz, 66 Hz < f ≤ 1 kHz	±2.0% rdg.±1.0 A
600.0 A	±10 A to ±1500 A (1 A)	45 Hz ≤ f ≤ 66 Hz	±1.5% rdg.±3 A
		30 Hz ≤ f < 45 Hz, 66 Hz < f ≤ 1 kHz	±2.0% rdg.±5 A
2000 A	±10 A to ±2840 A (1 A)	45 Hz ≤ f ≤ 66 Hz	±1.5% rdg.±30 A
		30 Hz ≤ f < 45 Hz, 66 Hz < f ≤ 1 kHz	±2.0% rdg.±50 A

3

(2) Current frequency

Range (Auto-range threshold)	Accuracy guarantee range (Resolution)	Measurement accuracy
99.99 Hz (more than 9999 counts)	30.00 Hz to 99.99 Hz (0.01 Hz)	±0.1% rdg.±0.01 Hz
999.9 Hz (less than 900 counts)	30.0 Hz to 999.9 Hz (0.1 Hz)	±0.1% rdg.±0.1 Hz* ¹

*1: Add ±0.2 Hz if less than 100.0 Hz.

Accuracy Table

(3) AC INRUSH (Rush current)

AC INRUSH measurement value (rms)

Range	Accuracy guarantee range (Resolution)	Accuracy guarantee frequency range	Measurement accuracy
60.00 A	3.00 A to 60.00 A (0.01 A)	40 Hz ≤ f ≤ 500 Hz	±5.0% rdg.±0.13 A
600.0 A	10.0 A to 600.0 A (0.1 A)	40 Hz ≤ f ≤ 500 Hz	±5.0% rdg.±1.3 A
2000 A	100 A to 2000 A (1 A)	40 Hz ≤ f ≤ 500 Hz* ¹	±5.0% rdg.±13 A

*1: Design values apply beyond 6×10⁵ A·Hz.

AC INRUSH PEAK value (Zero to Peak)

Range	Accuracy guarantee range (Resolution)	Accuracy guarantee frequency range	Measurement accuracy
60.00 A	3.0 A to 150.0 A (0.1 A)	40 Hz ≤ f ≤ 500 Hz	±5.0% rdg.±1.0 A
600.0 A	10 A to 1500 A (1 A)	40 Hz ≤ f ≤ 500 Hz	±5.0% rdg.±10 A
2000 A	100 A to 2840 A (10 A)	40 Hz ≤ f ≤ 500 Hz	±5.0% rdg.±100 A

(4) AUTO V (AC/DC voltage automatic detection)

During AC detection: Conforms to accuracy specifications described in "(7) AC+DC voltage" (p.52).

During DC detection: Conforms to accuracy specifications described in "(6) DC voltage" (p.50).

(5) AC voltage**Measurement value/MAX/MIN/AVE**

Range (Auto-range threshold)	Accuracy guarantee range (Resolution)	Accuracy guarantee frequency range *1 *2	Measurement accuracy		Input impedance *3
			Filter OFF	Filter ON	
6.000 V (more than 6000 counts)	0.000 V to 0.299 V (0.001 V)	15 Hz ≤ f < 45 Hz	±1.5% rdg. ±0.015 V	±2.0% rdg. ±0.015 V	3.2 MΩ±5%
		45 Hz ≤ f ≤ 66 Hz	±0.9% rdg. ±0.013 V	±1.4% rdg. ±0.013 V	
		66 Hz < f ≤ 1 kHz	±1.5% rdg. ±0.015 V	—	
	0.300 V to 6.000 V (0.001 V)	15 Hz ≤ f < 45 Hz	±1.5% rdg. ±0.005 V	±2.0% rdg. ±0.005 V	3.2 MΩ±5%
		45 Hz ≤ f ≤ 66 Hz	±0.9% rdg. ±0.003 V	±1.4% rdg. ±0.003 V	
		66 Hz < f ≤ 1 kHz	±1.5% rdg. ±0.005 V	—	

3

Accuracy Table

Range (Auto-range threshold)	Accuracy guarantee range (Resolution)	Accuracy guarantee frequency range *1 *2	Measurement accuracy		Input impedance *3
			Filter OFF	Filter ON	
60.00 V (more than 6000 counts/ less than 540 counts)	3.00 V to 60.00 V (0.01 V)	15 Hz ≤ f < 45 Hz	±1.5% rdg. ±0.05 V	±2.0% rdg. ±0.05 V	3.1 MΩ±5%
		45 Hz ≤ f ≤ 66 Hz	±0.9% rdg. ±0.03 V	±1.4% rdg. ±0.03 V	
		66 Hz < f ≤ 1 kHz	±1.5% rdg. ±0.05 V	–	
600.0 V (more than 6000 counts/ less than 540 counts)	30.0 V to 600.0 V (0.1 V)	15 Hz ≤ f < 45 Hz	±1.5% rdg. ±0.5 V	±2.0% rdg. ±0.5 V	3.0 MΩ±5%
		45 Hz ≤ f ≤ 66 Hz	±0.9% rdg. ±0.3 V	±1.4% rdg. ±0.3 V	
		66 Hz < f ≤ 1 kHz	±1.5% rdg. ±0.5 V	–	
1000 V (less than 540 counts)	50 V to 1000 V (1 V)	15 Hz ≤ f < 45 Hz	±1.5% rdg. ±5 V	±2.0% rdg. ±5 V	3.0 MΩ±5%
		45 Hz ≤ f ≤ 66 Hz	±0.9% rdg. ±3 V	±1.4% rdg. ±3 V	
		66 Hz < f ≤ 1 kHz	±1.5% rdg. ±5 V	–	

*1: Frequency range of 15 Hz ≤ f < 20 Hz is designed value.

*2: Within the frequency range of f < 45 Hz, the accuracy guarantee assumes a superposed DC voltage of less than 500 V.

*3: At 50 Hz AC.

Accuracy Table

PEAK MAX/PEAK MIN

Range	Accuracy guarantee range (Resolution)	Accuracy guarantee frequency range *1 *2	Measurement accuracy
6.000 V	0 V to ±12.00 V (0.01 V)	15 Hz ≤ f < 45 Hz	±1.8% rdg.±0.07 V
		45 Hz ≤ f ≤ 66 Hz	±1.5% rdg.±0.07 V
		66 Hz < f ≤ 1 kHz	±1.8% rdg.±0.07 V
60.00 V	±3.0 V to ±120.0 V (0.1 V)	15 Hz ≤ f < 45 Hz	±1.8% rdg.±0.7 V
		45 Hz ≤ f ≤ 66 Hz	±1.5% rdg.±0.7 V
		66 Hz < f ≤ 1 kHz	±1.8% rdg.±0.7 V
600.0 V	±30 V to ±1000 V *3 (1 V)	15 Hz ≤ f < 45 Hz	±1.8% rdg.±7 V
		45 Hz ≤ f ≤ 66 Hz	±1.5% rdg.±7 V
		66 Hz < f ≤ 1 kHz	±1.8% rdg.±7 V
1000 V	±50 V to ±1000 V *4 (1 V)	15 Hz ≤ f < 45 Hz	±1.8% rdg.±7 V
		45 Hz ≤ f ≤ 66 Hz	±1.5% rdg.±7 V
		66 Hz < f ≤ 1 kHz	±1.8% rdg.±7 V

*1: Frequency range of 15 Hz ≤ f < 20 Hz is designed value.

*2: Within the frequency range of f < 45 Hz, the accuracy guarantee assumes a superposed DC voltage of less than 500 V.

*3: Values of up to ±1200 V are displayed, but accuracy is not defined for display values in excess of 1000 V (which are provided as reference values).

*4: Values of up to ±1700 V are displayed, but accuracy is not defined for display values in excess of 1000 V (which are provided as reference values).

3

Accuracy Table

(6) DC voltage

Measurement value/MAX/MIN/AVE

Range (Auto-range threshold)	Accuracy guarantee range (Resolution)	Measurement accuracy	Input impedance*1
600.0 mV (more than 6000 counts)	0.0 mV to ± 600.0 mV (0.1 mV)	$\pm 0.5\%$ rdg. ± 0.5 mV	6.7 M Ω $\pm 5\%$
6.000 V (more than 6000 counts/ less than 540 counts)	0.000 V to ± 6.000 V (0.001 V)	$\pm 0.5\%$ rdg. ± 0.003 V	6.7 M Ω $\pm 5\%$
60.00 V (more than 6000 counts/ less than 540 counts)	0.00 V to ± 60.00 V (0.01 V)	$\pm 0.5\%$ rdg. ± 0.03 V	6.1 M Ω $\pm 5\%$
600.0 V (more than 6000 counts/ less than 540 counts)	0.0 V to ± 600.0 V (0.1 V)	$\pm 0.5\%$ rdg. ± 0.3 V	6.0 M Ω $\pm 5\%$
1500 V (less than 540 counts)	0 V to ± 1000 V *2 (1 V)	$\pm 0.5\%$ rdg. ± 3 V	6.0 M Ω $\pm 5\%$
	± 1001 V to ± 1700 V *2 (1 V)	$\pm 2.0\%$ rdg. ± 5 V	

*1: At DC input

*2: In the 1500 V range, the instrument can withstand input of up to 1000 V continuously or input in excess of 1000 V for no greater than 1 minute.

Accuracy Table

PEAK MAX/PEAK MIN

Range	Accuracy guarantee range (Resolution)	Measurement accuracy
600.0 mV	0 mV to ±1200 mV (1 mV)	±1.0% rdg.±7 mV
6.000 V	0.00 V to ±12.00 V (0.01 V)	±1.0% rdg.±0.07 V
60.00 V	0.0 V to ±120.0 V (0.1 V)	±1.0% rdg.±0.7 V
600.0 V	0 V to ±1000 V (1 V)	±1.0% rdg.±7 V
	±1001 V to ±1200 V (1 V)	±5.0% rdg.±7 V
1500 V	0 V to ±1000 V (1 V)	±1.0% rdg.±7 V
	±1001 V to ±1700 V (1 V)	±5.0% rdg.±7 V



Accuracy Table

(7) AC+DC voltage

Measurement value/MAX/MIN/AVE

Range (Auto-range threshold)	Accuracy guarantee range (Resolution)	Accuracy guarantee frequency range *1	Measurement accuracy		Input impedance *2	
			Filter OFF	Filter ON		
6.000 V (more than 6000 counts)	0.000 V to 0.299 V (0.001 V)	10 Hz ≤ f < 45 Hz	±1.5% rdg. ±0.023 V	±2.0% rdg. ±0.023 V	DC: 6.7 MΩ±5% AC: 3.2 MΩ±5%	
		DC, 45 Hz ≤ f ≤ 66 Hz	±1.0% rdg. ±0.023 V	±1.5% rdg. ±0.023 V		
		66 Hz < f ≤ 1 kHz	±1.5% rdg. ±0.023 V	–		
	0.300 V to 6.000 V (0.001 V)	10 Hz ≤ f < 45 Hz	±1.5% rdg. ±0.013 V	±2.0% rdg. ±0.013 V		DC: 6.7 MΩ±5% AC: 3.2 MΩ±5%
		DC, 45 Hz ≤ f ≤ 66 Hz	±1.0% rdg. ±0.013 V	±1.5% rdg. ±0.013 V		
		66 Hz < f ≤ 1 kHz	±1.5% rdg. ±0.013 V	–		
60.00 V (more than 6000 counts/ less than 540 counts)	3.00 V to 60.00 V (0.01 V)	10 Hz ≤ f < 45 Hz	±1.5% rdg. ±0.13 V	±2.0% rdg. ±0.13 V	DC: 6.1 MΩ±5% AC: 3.1 MΩ±5%	
		DC, 45 Hz ≤ f ≤ 66 Hz	±1.0% rdg. ±0.13 V	±1.5% rdg. ±0.13 V		
		66 Hz < f ≤ 1 kHz	±1.5% rdg. ±0.13 V	–		

Accuracy Table

Range (Auto-range threshold)	Accuracy guarantee range (Resolution)	Accuracy guarantee frequency range *1	Measurement accuracy		Input impedance *2
			Filter OFF	Filter ON	
600.0 V (more than 6000 counts/ less than 540 counts)	30.0 V to 600.0 V (0.1 V)	10 Hz ≤ f < 45 Hz	±1.5% rdg. ±0.7 V	±2.0% rdg. ±0.7 V	DC: 6.0 MΩ±5% AC: 3.0 MΩ±5%
		DC, 45 Hz ≤ f ≤ 66 Hz	±1.0% rdg. ±0.7 V	±1.5% rdg. ±0.7 V	
		66 Hz < f ≤ 1 kHz	±1.5% rdg. ±0.7 V	–	
1000 V (less than 540 counts)	50 V to 1000 V (1 V)	10 Hz ≤ f < 45 Hz	±1.5 %rdg. ±7 V	±2.0 %rdg. ±7 V	DC: 6.0 MΩ±5% AC: 3.0 MΩ±5%
		DC, 45 Hz ≤ f ≤ 66 Hz	±1.0 %rdg. ±7 V	±1.5 %rdg. ±7 V	
		66 Hz < f ≤ 1 kHz	±1.5 %rdg. ±7 V	–	

*1: Frequency range of 10 Hz ≤ f < 20 Hz is designed value.

*2: At DC input, 50 Hz AC input.

Accuracy Table

PEAK MAX/PEAK MIN

Range	Accuracy guarantee range (Resolution)	Accuracy guarantee frequency range *1	Measurement accuracy
6.000 V	0.00 V to ±12.00 V (0.01 V)	10 Hz ≤ f < 45 Hz	±1.5% rdg.±0.07 V
		DC, 45 Hz ≤ f ≤ 66 Hz	±1.0% rdg.±0.07 V
		66 Hz < f ≤ 1 kHz	±1.5% rdg.±0.07 V
60.00 V	±3.0 V to ±120.0 V (0.1 V)	10 Hz ≤ f < 45 Hz	±1.5% rdg.±0.7 V
		DC, 45 Hz ≤ f ≤ 66 Hz	±1.0% rdg.±0.7 V
		66 Hz < f ≤ 1 kHz	±1.5% rdg.±0.7 V
600.0 V	±30 V to ±1000 V *2 (1 V)	10 Hz ≤ f < 45 Hz	±1.5% rdg.±7 V
		DC, 45 Hz ≤ f ≤ 66 Hz	±1.0% rdg.±7 V
		66 Hz < f ≤ 1 kHz	±1.5% rdg.±7 V
1000 V	±50 V to ±1000 V *3 (1 V)	10 Hz ≤ f < 45 Hz	±1.5% rdg.±7 V
		DC, 45 Hz ≤ f ≤ 66 Hz	±1.0% rdg.±7 V
		66 Hz < f ≤ 1 kHz	±1.5% rdg.±7 V

*1: Frequency range of 10 Hz ≤ f < 20 Hz is designed value.

*2: Values of up to ±1200 V are displayed, but accuracy is not defined for display values in excess of 1000 V (which are provided as reference values).

*3: Values of up to ±1700 V are displayed, but accuracy is not defined for display values in excess of 1000 V (which are provided as reference values).

(8) Voltage frequency

Range (Auto-range threshold)	Accuracy guarantee range (Resolution)	Measurement accuracy
9.999 Hz (more than 9999 counts)	1.000 Hz to 9.999 Hz (0.001 Hz)	$\pm 0.1\%$ rdg. ± 0.003 Hz
99.99 Hz (more than 9999 counts/less than 900 counts)	1.00 Hz to 99.99 Hz (0.01 Hz)	$\pm 0.1\%$ rdg. ± 0.01 Hz
999.9 Hz (less than 900 counts)	1.0 Hz to 999.9 Hz (0.1 Hz)	$\pm 0.1\%$ rdg. ± 0.1 Hz* ¹

*1: Add ± 0.2 Hz if less than 100.0 Hz.

3

(9) Continuity check

Range	Accuracy guarantee range (Resolution)	Measurement current	Measurement accuracy
600.0 Ω	0.0 Ω to 600.0 Ω (0.1 Ω)	200 μ A $\pm 20\%$	$\pm 0.7\%$ rdg. ± 0.5 Ω

Accuracy Table

(10) Resistance

Range (Auto-range threshold)	Accuracy guarantee range (Resolution)	Measurement current	Measurement accuracy
600.0 Ω (more than 6000 counts)	0.0 Ω to 600.0 Ω (0.1 Ω)	200 $\mu\text{A}\pm 20\%$	$\pm 0.7\%$ rdg. $\pm 0.5 \Omega$
6.000 k Ω (more than 6000 counts/less than 540 counts)	0.000 k Ω to 6.000 k Ω (0.001 k Ω)	100 $\mu\text{A}\pm 20\%$	$\pm 0.7\%$ rdg. $\pm 0.005 \text{ k}\Omega$
60.00 k Ω (more than 6000 counts/less than 540 counts)	0.00 k Ω to 60.00 k Ω (0.01 k Ω)	10 $\mu\text{A}\pm 20\%$	$\pm 0.7\%$ rdg. $\pm 0.05 \text{ k}\Omega$
600.0 k Ω (less than 540 counts)	0.0 k Ω to 600.0 k Ω (0.1 k Ω)	1 $\mu\text{A}\pm 20\%$	$\pm 0.7\%$ rdg. $\pm 0.5 \text{ k}\Omega$

(11) Diode

Range	Accuracy guarantee range (Resolution)	Short-circuit current	Measurement accuracy
1.800 V	0.000 V to 1.800 V ^{*1} (0.001 V)	200 $\mu\text{A}\pm 20\%$	$\pm 0.7\%$ rdg. $\pm 0.005 \text{ V}$

*1: Beeping buzzer tone at forward connection (0.15 V to 1.8 V). Continuous buzzer tone and red backlight lights up if less than 0.15 V.

(12) Capacitance

Range (Auto-range threshold)	Accuracy guarantee range (Resolution)	Discharge current	Measurement accuracy
1.000 μF (more than 1100 counts)	0.000 μF to 1.100 μF (0.001 μF)	10 nA \pm 20% 100 nA \pm 20% 1 $\mu\text{A}\pm$ 20%	\pm 1.9% rdg. \pm 0.005 μF
10.00 μF (more than 1100 counts/less than 100 counts)	0.00 μF to 11.00 μF (0.01 μF)	100 nA \pm 20% 1 $\mu\text{A}\pm$ 20% 10 $\mu\text{A}\pm$ 20%	\pm 1.9% rdg. \pm 0.05 μF
100.0 μF (more than 1100 counts/less than 100 counts)	0.0 μF to 110.0 μF (0.1 μF)	1 $\mu\text{A}\pm$ 20% 10 $\mu\text{A}\pm$ 20% 100 $\mu\text{A}\pm$ 20%	\pm 1.9% rdg. \pm 0.5 μF
1000 μF (less than 100 counts)	0 μF to 1100 μF (1 μF)	10 $\mu\text{A}\pm$ 20% 100 $\mu\text{A}\pm$ 20% 200 $\mu\text{A}\pm$ 20%	\pm 1.9% rdg. \pm 5 μF

3

(13) Temperature (Thermocouples (K))

Range	Accuracy guarantee range (Resolution)	Measurement accuracy *1
$^{\circ}\text{C}$	-40.0 $^{\circ}\text{C}$ to 400.0 $^{\circ}\text{C}$ (0.1 $^{\circ}\text{C}$)	\pm 0.5% rdg. \pm 3.0 $^{\circ}\text{C}$
$^{\circ}\text{F}$ *2	-40.0 $^{\circ}\text{F}$ to 752.0 $^{\circ}\text{F}$ (0.1 $^{\circ}\text{F}$)	\pm 0.5% rdg. \pm 5.4 $^{\circ}\text{F}$

*1: Conditions (In an environment where the temperature of the instrument is \pm 1 $^{\circ}\text{C}$ and stable)*2: Instrument can be made to display readings in Fahrenheit ($^{\circ}\text{F}$) by means of special operation.

4

Repairs, Inspections, and Cleaning

4.1 Troubleshooting

Symptom	Verification and/or Solution
• The instrument is indicating an abnormal measured value.	• Is the measured current value too small for the instrument's measurement range?
	• Wrap the wire around the jaw one or more times. Each additional wrap of the wire will increase the measured value, so that wrapping it once yields a measured value that is twice the actual value and wrapping it twice yields a measured value that is three times the actual value.
	• Is the tip of the jaw open?
	• Is the jaw damaged? • If the jaw is damaged or cracked, it will not be able to measure current accurately. Send the instrument for repair.
	• Displayed values can frequently fluctuate due to induction potential even when no voltage is applied. This, however, is not a malfunction.

4

Troubleshooting

Symptom	Verification and/or Solution
<ul style="list-style-type: none"> When readings from the instrument are compared with those of another clamp-on current meter, the measured values differ. 	<ul style="list-style-type: none"> The instrument cannot accurately measure waveforms that contain a component that falls outside the frequency characteristics range. Since the instrument performs true RMS measurement, it can accurately measure distorted waveforms. When measuring a distorted waveform, the measured value will differ from a clamp-on current meter that uses the averaging method.
<ul style="list-style-type: none"> The current value is larger than expected. A current value is displayed even though there is no input. 	<ul style="list-style-type: none"> The instrument cannot perform measurement accurately in the presence of a strong magnetic field from a source such as a nearby transformer or high-current circuit or in the presence of a strong electric field from a source such as a wireless device. If there are any wires carrying a large current near the tip of the jaws (on the outside of the jaws), the instrument will be unable to make accurate measurements.
<ul style="list-style-type: none"> A sound (vibration) is being emitted by the instrument's jaw. 	<ul style="list-style-type: none"> The jaw may emit sound (vibration) when measuring AC currents in excess of approx. 500 A, however, there is no effect on the measurement.
<ul style="list-style-type: none"> The measured value does not appear. No measured value is displayed, even when the test leads are shorted. Zero adjustment is impossible. 	<ul style="list-style-type: none"> Check the continuity of the test leads. (p.23) If a wiring break is found, replace the test leads. Insert the test leads all the way. Use the proper measurement method. If no problem can be found, the instrument may be damaged. Send the instrument for repair.

4.2 Error display

Error display	Description	Solution
Err 001	ROM error Program	When the error appears in the display, it is necessary to repair the instrument. Please contact your authorized Hioki distributor or reseller.
Err 002	ROM error Adjustment data	
Err 005	ADC error Hardware malfunction	
Err 008	Bluetooth error Hardware malfunction (only for model CM4142)	

4

Insert/Replace Batteries

4.3 Insert/Replace Batteries

WARNING



- To avoid electric shock, turn off the instrument and disconnect the test leads before installing or replacing the batteries.
- Handle and dispose of batteries in accordance with local regulations.
- To prevent instrument damage or an electric shock, use only the screw that are originally installed for securing the battery cover in place. If you have lost a screw or find that a screw is damaged, please contact your authorized Hioki distributor or reseller.

The  indicator lights up when the battery charge diminishes. Replace the batteries as soon as possible. The batteries may die if the backlight turns on or the buzzer sounds. After use, be sure to turn off the instrument.

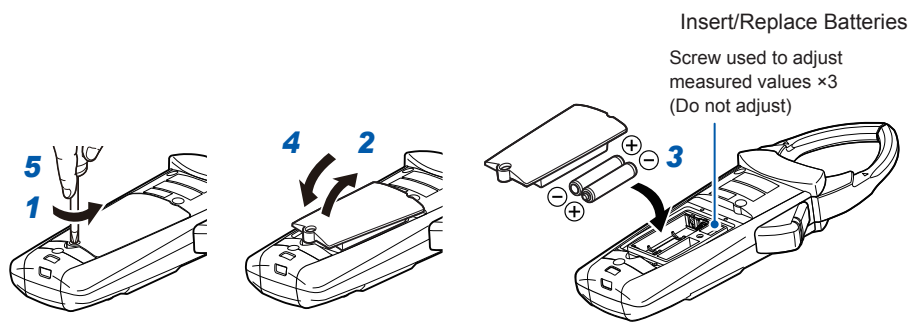

Do not adjust any screws other than the screw holding the battery cover in place. Do not adjust the three screws underneath the cover, which are used to adjust measured values, as doing so may prevent accurate measurement.

4

Battery indicator	Description
	Fully charged.
	As the battery charge diminishes, black charge bars disappear, one by one, from the left of the battery indicator.
	The battery voltage is low. Replace the batteries as soon as possible.
	(Flashes) The battery is exhausted. Replace the batteries.

Cleaning

4.4 Cleaning

To clean the instrument, wipe it gently with a soft cloth moistened with water or mild detergent.

Index

A

AC current	17, 44
AC+DC voltage.....	17, 52
AC INRUSH.....	21, 46
AC voltage	17, 47
Auto hold	15, 16
Auto Power Save (APS).....	26, 27
AUTO V	11, 17, 47
AVG (average) value	19

B

Backlight.....	26, 27, 62
Bluetooth	11, 29, 61
Breaking (Disconnection)	9, 13, 60
Buzzer sound.....	22, 27, 62

C

Capacitance.....	24, 57
Continuity.....	17, 23, 55, 60
Current.....	14, 33, 38

D

DC voltage.....	17, 27, 50
Diode	17, 24, 56
Disconnection (Breaking)	9, 13, 60
DT4910 Thermocouples (K)	5, 25

F

Filter.....	20
Fluctuate.....	59
Frequency.....	14, 22, 45

G

GENNECT Cross.....	29, 30
--------------------	--------

J

Jaw	7, 12
-----------	-------

M

Manual hold	15
MAX value	19

Verifying Package Contents

Verifying Package Contents

- Model CM4141 or CM4142 AC Clamp Meter
- Model L9207-10 Test Lead

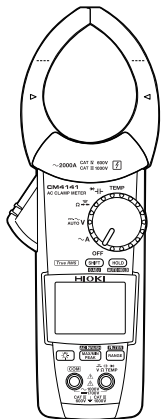

- Model L9207-10 Test Lead
- Model C0203 Carrying Case



- LR03 Alkaline battery ×2
- Instruction Manual*
- Operating Precautions (0990A907)
- Precautions Concerning Use of Equipment that Emits Radio Waves (only for model CM4142)



* Instruction manuals may also be available in other languages.
Please visit our website at <http://www.hioki.com>

Warranty Certificate HIOKI

Model	Serial number	Warranty period Three (3) years from date of purchase (___ / ___)
-------	---------------	--

Customer name: _____
 Customer address: _____

Important

- Please retain this warranty certificate. Duplicates cannot be reissued.
- Complete the certificate with the model number, serial number, and date of purchase, along with your name and address. The personal information you provide on this form will only be used to provide repair service and information about Hioki products and services.

This document certifies that the product has been inspected and verified to conform to Hioki's standards. Please contact the place of purchase in the event of a malfunction and provide this document, in which case Hioki will repair or replace the product subject to the warranty terms described below.

Warranty terms

1. The product is guaranteed to operate properly during the warranty period (three [3] years from the date of purchase). If the date of purchase is unknown, the warranty period is defined as three (3) years from the date (month and year) of manufacture (as indicated by the first four digits of the serial number in YYYYMM format).
2. If the product came with an AC adapter, the adapter is warranted for one (1) year from the date of purchase.
3. The accuracy of measured values and other data generated by the product is guaranteed as described in the product specifications.
4. In the event that the product or AC adapter malfunctions during its respective warranty period due to a defect of workmanship or materials, Hioki will repair or replace the product or AC adapter free of charge.
5. The following malfunctions and issues are not covered by the warranty and as such are not subject to free repair or replacement:
 - 1. Malfunctions or damage of consumables, parts with a defined service life, etc.
 - 2. Malfunctions or damage of connectors, cables, etc.
 - 3. Malfunctions or damage caused by shipment, dropping, relocation, etc., after purchase of the product
 - 4. Malfunctions or damage caused by inappropriate handling that violates information found in the instruction manual or on precautionary labeling on the product itself
 - 5. Malfunctions or damage caused by a failure to perform maintenance or inspections as required by law or recommended in the instruction manual
 - 6. Malfunctions or damage caused by fire, storms or flooding, earthquakes, lightning, power anomalies (involving voltage, frequency, etc.), war or unrest, contamination with radiation, or other acts of God
 - 7. Damage that is limited to the product's appearance (cosmetic blemishes, deformation of enclosure shape, fading of color, etc.)
 - 8. Other malfunctions or damage for which Hioki is not responsible
6. The warranty will be considered invalidated in the following circumstances, in which case Hioki will be unable to perform service such as repair or calibration:
 - 1. If the product has been repaired or modified by a company, entity, or individual other than Hioki
 - 2. If the product has been embedded in another piece of equipment for use in a special application (aerospace, nuclear power, medical use, vehicle control, etc.) without Hioki's having received prior notice
7. If you experience a loss caused by use of the product and Hioki determines that it is responsible for the underlying issue, Hioki will provide compensation in an amount not to exceed the purchase price, with the following exceptions:
 - 1. Secondary damage arising from damage to a measured device or component that was caused by use of the product
 - 2. Damage arising from measurement results provided by the product
 - 3. Damage to a device other than the product that was sustained when connecting the device to the product (including via network connections)
8. Hioki reserves the right to decline to perform repair, calibration, or other service for products for which a certain amount of time has passed since their manufacture, products whose parts have been discontinued, and products that cannot be repaired due to unforeseen circumstances.

HIOKI E.E. CORPORATION
18-07 EN-3