

A compact LCD DPM ideally suited to low or high volume applications, it features an exceptionally large display in a miniature package. The meter will plug directly into a SIL socket or can be panel mounted using the snap-in bezel provided. The low profile bezel incorporates a flat reverse printed window giving a superb appearance that cannot be damaged or rubbed off by contact.

- 🔊 12.5mm (0.5") Digit Height
- 🔊 Logic Selectable Decimal Points
- 🔊 Auto-zero
- 🔊 Auto-polarity
- 🔊 200mV d.c. Full Scale Reading (F.S.R.)
- 🔊 Low Battery Indication
- 🔊 Digital Hold



SCALING

Two resistors may be used to alter the full scale reading of the meter - see table.

Note that the meter will have to be re-calibrated by adjusting the calibration pot CAL.

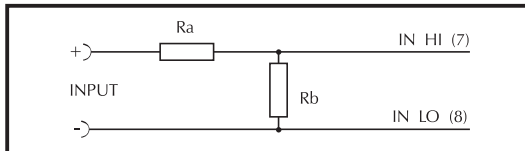

Required F.S.R.	Ra	Rb
2V	910k	100k
20V	1M	10k
200V	1M	1k
2kV	Note	100R
200µA	0R	1k
2mA	0R	100R
20mA	0R	10R
200mA	0R	1R

Note
Ensure Ra is rated for high voltage use.

Stock Number Standard Meter

Specification	Min.	Typ.	Max.	Unit
Accuracy (overall error) *		0.05	0.1	% (±1 count)
Linearity			±1	count
Sample rate		3		samples/sec
Operating temperature range	0		50	°C
Temperature stability		100		ppm/°C
Supply voltage (V+ to V-)	7.5	9	14	V
Supply current		150		µA
Input leakage current (Vin = 0V)		1	10	pA

* To ensure maximum accuracy, re-calibrate periodically.

CONNECTOR SOURCING GUIDE

METHOD	FARNELL	MOLEX	PANDUIT	RS	SAMTEC
PCB socket	103-963			402-642	
IDC	429-508	38-00-2102	CE 100 F28-12	483-461	HCSS

DIMENSIONS All dimensions in mm (inches)

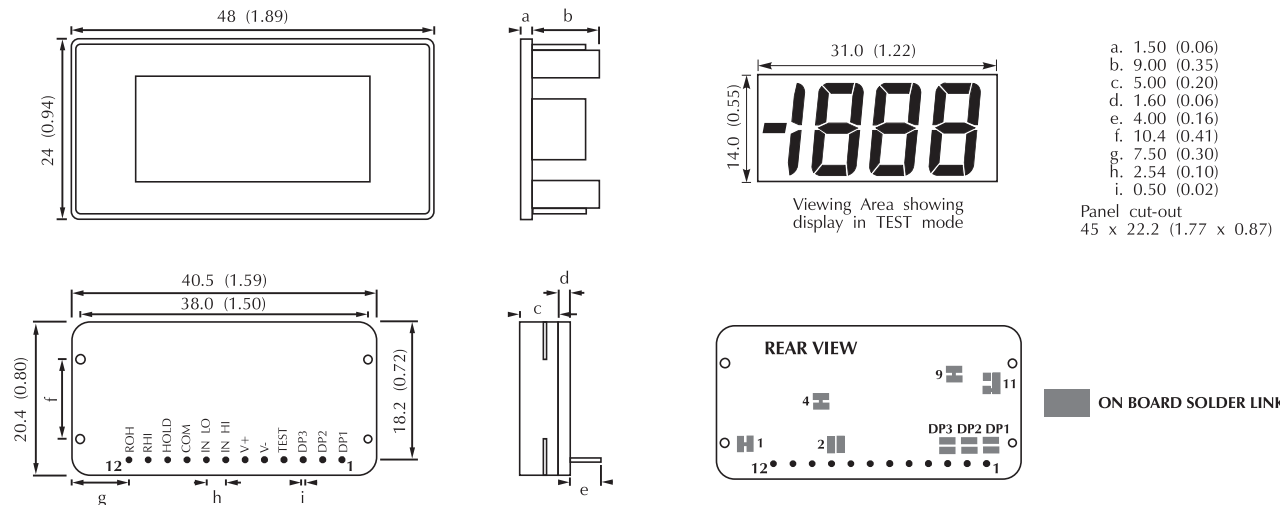

PANEL FITTING

Fit the bezel to the front of the panel and then locate the meter into the bezel from behind. Alternatively the meter and bezel may be assembled before fitting into the front of the panel but care must be taken not to use excessive force. Finally fit the window into the front of the bezel.

PIN FUNCTIONS

- 1. DP1 199.9
- 2. DP2 19.99
- 3. DP3 1.999
- 4. TEST Connect to V+ to display segments as illustrated. It should not be operated for more than a few seconds as the D.C. Voltage applied to the LCD may 'burn' the display. This pin is normally at 5V below V+ and is the ground for the digital section of the meter. It can be used to power external logic up to a maximum of 1mA.
- 5. V- Negative power supply connection.
- 6. V+ Positive power supply connection.
- 7. IN HI Positive measuring differential input.
- 8. IN LO Negative measuring differential input.
- 9. COM The ground for the analogue section of the A/D converter, held actively at 2.8V (nom.) below V+. COM must not be allowed to sink excessive current (> 100µA) by connecting it directly to a higher voltage.
- 10. HOLD If left floating or connected to TEST (pin 4), the meter will continuously measure the input voltage. When connected to V+ the last displayed reading will be held indefinitely.
- 11. RHI Positive input for reference voltage (connected via Link 1 to ROH).
- 12. ROH Positive output from internal reference.

SAFETY

To comply with the Low Voltage Directive (LVD 93/68/EEC), input voltages to the module's pins must not exceed 60Vdc. If voltages to the measuring inputs do exceed 60Vdc, then fit scaling resistors externally to the module. The user must ensure that the incorporation of the DPM into the user's equipment conforms to the relevant sections of BS EN 61010 (Safety Requirements for Electrical Equipment for Measuring, Control and Laboratory Use).

VARIOUS OPERATING MODES

ON-BOARD LINKS: In order to quickly and easily change operating modes for different applications, the meter has several on-board links. They are designed to be easily opened (cut) or shorted (soldered). Do not connect more than one meter to the same power supply if the meters cannot use the same signal ground. Taking any input beyond the power supply rails will damage the meter.

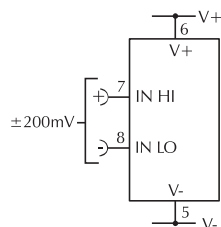

Check Link 2 is **SHORTED**.

Measuring a floating voltage source of 200mV full scale.

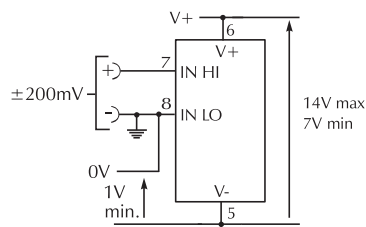

Check Link 2 is **OPEN**.

Split supply operation.

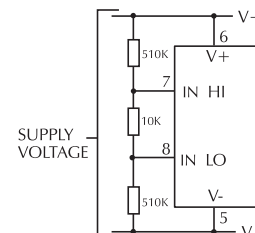

Check Link 2 is **OPEN**.

Measuring a supply voltage. (min. 7.5V, max. 14V).

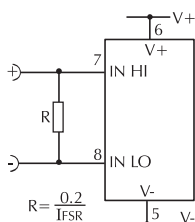

Check Link 2 is **SHORTED**.

Measuring current. Supply **MUST** be isolated.

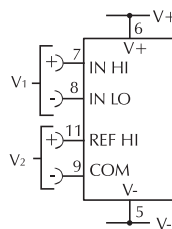

Check Links 1 & 4 are **OPEN**.

Measuring the ratio of two voltages.
Reading = 1000 V₁/V₂
50mV < V₂ < 200mV
V₁ < 2V₂.

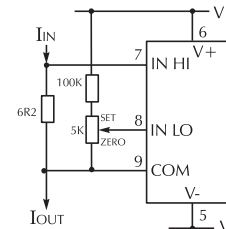

Check Link 2 is **OPEN**.

Measuring 4-20mA to read 0-999. (supply **MUST** be isolated).