

User Manual



IRTC400
Thermal Imager



Introduction

Congratulations on your purchase of the Triplet IRTC400 Thermal Imaging Camera. This instrument is useful in many applications such as preventative maintenance, troubleshooting of electrical and HVAC systems, mechanical breakdowns, water leaks and moisture buildup, heat loss from missing insulation and faulty windows/doors, automotive repair, and other places to find leaks and hot spots. With proper care the instrument will last for many years of accuracy and service.

Features

- 2.4" (61mm) focus-free, color TFT display with 320 x 240 resolution
- Center spot and high/low temperature tracking on image
- Audible and visual user programmable high/low temperature alarms
- 4-button easy-to-use menu
- Real time clock/calendar
- Image gallery
- Built-in LED worklight
- Auto power off with disable
- USB interface for transferring images (.bmp) and recharging
- Includes 3.7V rechargeable Lithium-Ion battery, USB cable, software, and 32G microSD card

Safety

International Safety Symbols This symbol, adjacent to another symbol or terminal, indicates the user must refer to the manual for further information. Cautions o Improper use can damage the meter. Please read and understand all of the information provided in this User Guide and other included documentation before use. o Use extreme caution when the laser pointers are on. o Do not point the beam toward anyone's eye or allow the beam to strike the eye from a reflective surface. o Do not use the laser near explosive gases or in other potentially explosive areas. o Refer to the CAUTION statement label (shown below) for critical safety information.



Meter Description

1. Upper Housing
2. Interface Protective Cover
3. Lower Housing
4. USB Type-C Interface Connector
5. SD Card Slot
6. Tripod Mount
7. Laser Emission Window
8. LED Light
9. Infrared Camera Lens
10. Trigger/Image Capture
11. LCD Display
12. OK Button
13. Up Button
14. Power/Back Button
15. Down Button

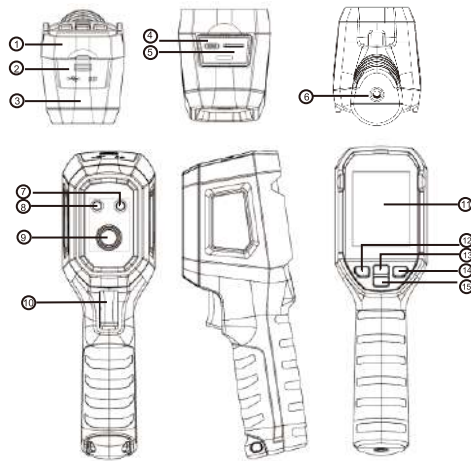

Display Indicators and Icons

- Display size: 2.4" (495mmx377mm)
- Display resolution: 320 (vertical) x 240 (horizontal)



1. Center Point Temperature
2. CenterPoint
3. Low Temperature Point
4. Date and Time
5. Battery Status
6. Temperature Bar
7. High Temperature Point

Operation

Power On/Off

When the thermal imager is not turned on, long press the power button for 3s to power on. When the thermal imager is in the suspend state, short press the power button for 1 s to power on. When the thermal imager is turned on, short press the power button for 1s to enter the suspend state. Long press the power button for 8s,

Menu

Short press the OK button to enter the menu interface. Short press the Back button to return to the upper menu. Short press the trigger to directly return to the main interface of the thermal imager.



Image View

In the menu, select Image View, and then short press the OK button to enter the image viewing interface. Press the Up/Down button to select an image. Press the OK button twice to view the Picture Info or Delete images.



Temperature Mark

In the menu, short press the Up/Down button to select Temper Mark, and then short press the OK button to enter the temperature mark interface. Center Point Hi/Lo Point Palette/Date & Time can be set in this interface. For example, select Center Point, and then press the OK button to turn on/off this function.



HI/LO Alert

In the menu, short press the Up/Down button to select HI/LO Alert, and then short press the OK button to enter the alert setting interface. Temper Alert, Buzzer, HI Alert and LO Alert can be set in this interface.

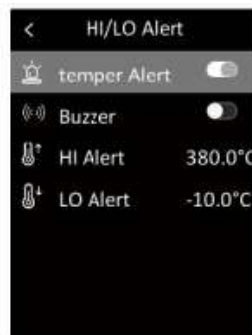

LED light

In the menu, short press the Up/Down button to select Hand Light, and then short press the OK button to turn on/off the flashlight.

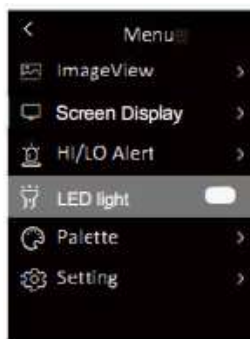

Palette

In the menu, short press the Up/Down button to select Palette, and then short press the OK button to enter the palette selection interface. Short press the Up/Down button to step through six palettes: Rainbow, Iron, White Hot, Black Hot, Rainbow HC, Lava, and short press the OK button to confirm the selected palette.

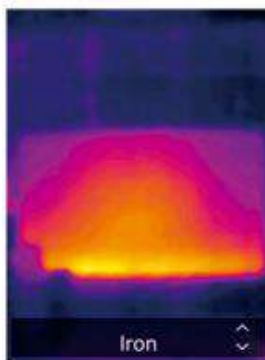

Language (English Only)

Temperature Unit

In the menu, short press the Up/Down button to select Setting, and then short press the OK button to enter the submenu. In the submenu, short press the Up/Down button to select Temper Unit, and short press the OK button to switch between °C/°F.

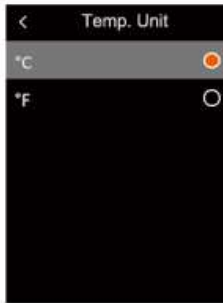

Measured Parameters

In the menu, short press the Up/Down button to select setting, and then short press the OK button to enter the submenu. In the submenu, short press the UP/Down button to select Emissivity or Temperature Compensation, and short press the OK button for settings.

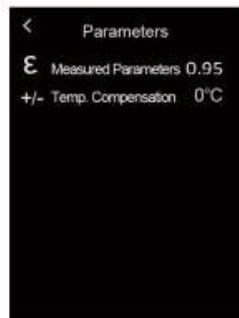

Laser

In the menu, short press the Up/Down button to select Setting, and then short press the OK button to enter the submenu. In the submenu, short press the Up/ Down button to select Laser, and short press the OK button to turn on/off the laser.

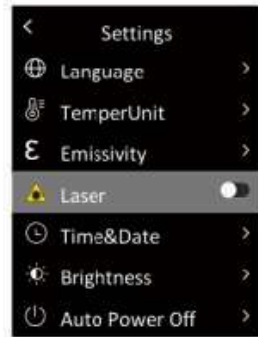

Time & Date

In the menu, short press the Up/Down button to select Setting, and then short press the OK button to enter the submenu. In the submenu, short press the Up/ Down button to select Time & Date, and short press the OK button to enter the setting interface. The Time Format can switch between 12H and 24H. Press the Up/Down button to adjust the value of time and date, and short press the OK button to confirm.

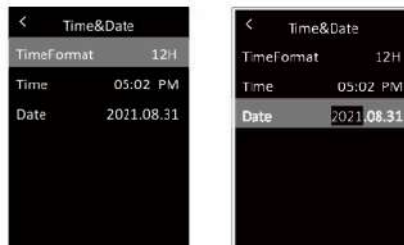

Brightness

In the menu, short press the Up/Down button to select Setting, and then short press the OK button to enter the submenu. In the submenu, short press the Up/ Down button to select Brightness, and short press the OK button to enter the setting interface. The brightness can be Low, Middle, or High



Auto Power Off

In the menu, short press the Up/Down button to select Setting, and then short press the OK button to enter the submenu. In the submenu, short press the Up/ Down button to select Auto Power Off, and short press the OK button to enter the setting interface. In this interface, users can set the auto power off time (5/ 10/30min) or turn off the auto power off function.

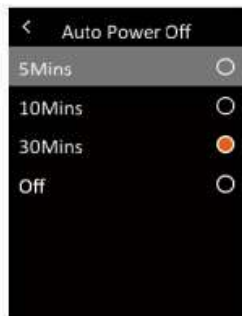

Auto Save

In the menu, short press the Up/Down button to select Setting, and then short press the OK button to enter the submenu. In the submenu, short press the Up/ Down button to select Auto Save. Short press the OK button to turn on/off the auto save function.



Format SD

In the menu, short press the Up/Down button to select Setting, and then short press the OK button to enter the submenu. In the submenu, short press the Up/ Down button to select Format SD and short press the OK button to enter the setting interface. Press the OK button select Yes or No

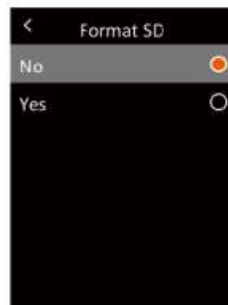

Factory Reset

In the menu, short press the Up/Down button to select Setting, and then short press the OK button to enter the submenu. In the submenu, short press the Up/ Down button to select Factory Reset and short press the OK button to enter the setting interface. Press the OK button select Yes or No. In this picture, it will jump back to the main interface when you touch the screen.



USB Communication and PC Analysis Software

1. Please refer to the instructions to download and install the PC software.
2. Connect the USB data cable to the computer. Users can view images and analyze data via the PC software.
3. To use the PC software correctly, please read the Software User Manual.
4. During USB communication, do not directly unplug the USB cable. If users want to disconnect the device when it has been successfully connected to the computer, they can select Remove Device in the lower right corner of the computer.

Maintenance

Use a wet cloth or weak soap solution to clean the outer shell of the device. Do not use abrasives, isopropyl alcohol or solvents to clean the outer shell, lens or window.

Specifications

Sensor	Uncooled infrared focal plane thermal imaging sensor
Pixel size	17 μ m
Infrared spectrum bandwidth	8~14 μ m
Thermal imaging pixels	10800 (120*90)
Thermal imaging sensitivity	\leq 60mK
Field of view (FOV)	50°(H) x 38°(V)
Spatial resolution (IFOV)	73 mrad
Rate	\leq 25Hz
Minimum imaging distance	0.1m
Focus	Focus-free
Temperature range	-20°C ~ 400°C
Accuracy	\pm 2°C or \pm 2% , whichever is greater (-10°C ~ 400°C room temperature 25°C)
Measurement units	°C/°F
Resolution	0.1°C
Emissivity	0.95 (default) 0.01~1.00
Temperature display	Center point temperature, high/low temperature tracking
Palettes	lava , rainbow HC , black hot , white hot, Ironbow, Rainbow
Display type	2.4" TFT LCD
Display resolution	320 x 240

Buttons	4 buttons (power, up, down, OK) 1 trigger
Laser	√(Class 2)
LED Light	√
Temperature alarms	LCD, LED, buzzer
Image storage	Micro SD Card
Image format	BMP
PC analysis software	√
USB communication	Type-C USB
Battery	Li-ion 3.7V/2600mAh 18650
Operating time	Continuous operating time ≥8h
Charging time	≤2.5h
Charging voltage/current	5V / 2A
Power on speed	0s (wake up) / 5s (power on)
Auto power off	5min/10min/30min(default)/off
Operating temperature	0 ~ 50°C (32 ~ 140°F)
Storage temperature	-20 ~ 60°C (-4 ~ 140°F)
Operating humidity	< 85%RH (Operating humidity)
IP rating	IP54
Drop proof	2m
Product size (L×W×H)	197 x 72 x 60 mm
Product weight	310g
Certificates	CE, FCC, RoHS
Accessories	User manual, Type-C USB cable, 32GB Micro SD card

Warranty

Triplett / Jewell Instruments extends the following warranty to the original purchaser of these goods for use. Triplett warrants to the original purchaser for use that the products sold by it will be free from defects in workmanship and material for a period of (1) one year from the date of purchase. This warranty does not apply to any of our products which have been repaired or altered by unauthorized persons in any way or purchased from unauthorized distributors so as, in our sole judgment, to injure their stability or reliability, or which have been subject to misuse, abuse, misapplication, negligence, accident or which have had the serial numbers altered, defaced, or removed. Accessories, including batteries are not covered by this warranty

Copyright © 2022 Triplett