

Series **3**

DIGITAL FORCE GAUGES

User's Guide



Thank you...



Thank you for purchasing a Mark-10 Series 3 digital force gauge, designed for tension and compression force testing applications from 0.12 lbF to 500 lbF (0.5 N to 2,500 N) full scale. The Series 3 is an essential component of a force testing system, typically also comprising a test stand, grips, and data collection software.

With proper usage, we are confident that you will get many years of great service with this product. Mark-10 force gauges are ruggedly built for many years of service in laboratory and industrial environments.

This User's Guide provides setup, safety, and operation instructions. Dimensions and specifications are also provided. For additional information or answers to your questions, please do not hesitate to contact us. Our technical support and engineering teams are eager to assist you.

Before use, each person who is to use a Series 3 force gauge should be fully trained in appropriate operation and safety procedures.

TABLE OF CONTENTS

OVERVIEW.....	2
POWER.....	3
SETUP	4
HOME SCREEN AND CONTROLS	5
OPERATING MODES.....	7
CHANGING THE UNITS.....	7
DIGITAL FILTERS.....	7
SET POINT INDICATORS.....	8
COMMUNICATIONS AND OUTPUTS	9
CALIBRATION	10
OTHER SETTINGS.....	15
SPECIFICATIONS	17

1 OVERVIEW

1.1 List of included items

Qty.	Part No.			Description
	M3-012 – M3-20	M3-50 – M3-100	M3-200 – M3-500	
1	12-1049	12-1049	12-1049	Carrying Case
1	AC1030 / AC1031 / AC1032	AC1030 / AC1031 / AC1032	AC1030 / AC1031 / AC1032	AC adapter body with US, EU, or UK prong
1	08-1026	08-1026	08-1026	Battery (inside the gauge)
1	G1024	G1024	G1031	Extension rod
1	G1026	G1026	G1033	Cone
1	G1025	G1025	G1032	Chisel
1	G1027	G1027	G1034	V-groove
1	G1029	G1029	G1036	Flat
1	G1028	G1038	G1035	Hook
1	N/A	G1039	G1037	Coupling
1	-			Certificate of calibration
1	09-1165			USB cable
-	USB driver, MESUR® Lite software, MESUR®gauge evaluation software, User's Guide			

1.2 Safety / Proper Usage

Caution!

Note the force gauge's capacity before use and ensure that the capacity is not exceeded. Producing a force greater than 200% of the gauge's capacity can damage the internal load cell. An overload can occur whether the gauge is powered on or off.

Typical materials suitable for testing include many manufactured items, such as springs, electronic components, fasteners, caps, films, mechanical assemblies, and many others. Items that should not be used with the gauge include potentially flammable substances or products, items that can shatter in an unsafe manner, and any other components that can present an exceedingly hazardous situation when acted upon by a force.

The following safety checks and procedures should be performed before and during operation:

1. Never operate the gauge if there is any visible damage to the AC adapter or the gauge itself.
2. Ensure that the gauge is kept away from water or any other electrically conductive liquids at all times.
3. The gauge should be serviced by a trained technician only. AC power must be disconnected and the gauge must be powered off before the housing is opened.
4. Always consider the characteristics of the sample being tested before initiating a test. A risk assessment should be carried out beforehand to ensure that all safety measures have been addressed and implemented.
5. Wear eye and face protection when testing, especially when testing brittle samples that have the potential to shatter under force. Be aware of the dangers posed by potential energy that can accumulate in the sample during testing. Extra bodily protection should be worn if a destructive failure of a test sample is possible.

6. In certain applications, such as the testing of brittle samples that can shatter, or other applications that could lead to a hazardous situation, it is strongly recommended that a machine guarding system be employed to protect the operator and others in the vicinity from shards or debris.
7. When the gauge is not in use, ensure that the power is turned off.

2 POWER

The gauge is powered either by an 8.4V NiMH rechargeable battery or by an AC adapter. Since the batteries are subject to self discharge, it may be necessary to recharge the unit after a prolonged period of storage. Plug the accompanying charger into the AC outlet and insert the charger plug into the receptacle on the gauge (refer to the illustration below). The battery will fully charge in approximately 8 hours.

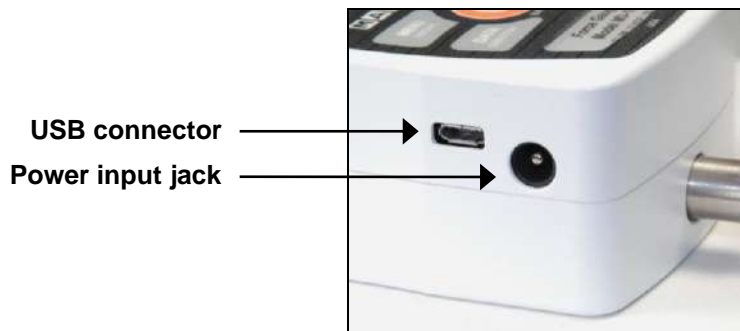





Caution!

Do not use chargers or batteries other than supplied or instrument damage may occur.

If the AC adapter is plugged in, an icon appears in the lower left corner of the display, as follows: 

If the AC adapter is not plugged in, battery power drainage is denoted in a five-step process:

1. When battery life is greater than 75%, the following indicator is present: 
2. When battery life is between 50% and 75%, the following indicator is present: 
3. When battery life is between 25% and 50%, the following indicator is present: 
4. When battery life is less than 25%, the following indicator is present: 
5. When battery life drops to approximately 2%, the indicator from step 4 will be flashing. Several minutes after (timing depends on usage and whether the backlight is turned on or off), a message appears, "BATTERY VOLTAGE TOO LOW. POWERING OFF". An audio tone will sound and the gauge will power off.

The gauge can be configured to automatically power off following a period of inactivity. Refer to the **Other Settings** section for details.

If battery replacement is necessary, it can be accessed by separating the two halves of the gauge. Refer to the **Mechanical Setup** section for details.

3 SETUP

3.1 Mechanical Setup

3.1.1 Loading shaft orientation

In order to accommodate a variety of testing requirements, the orientation of the loading shaft may be set up in either of the two positions shown below. In order to change the loading shaft orientation, loosen the two captive screws on the back side of the housing, separate the two housing halves, rotate one half 180 degrees, and reassemble. Exercise care when reassembling the two halves of the housing, ensuring that internal wires do not interfere.

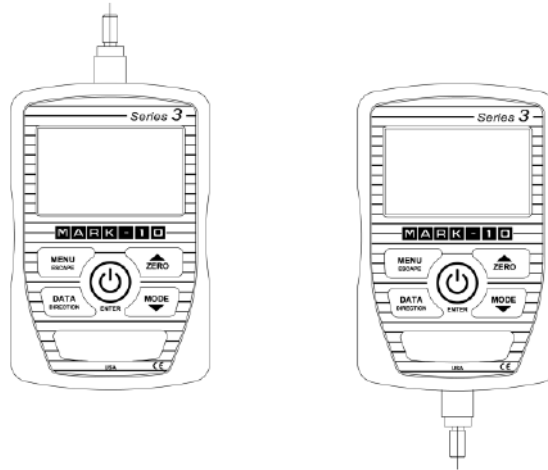

Load cell shaft up

Load cell shaft down

3.1.2 Mounting to a plate

Proper mounting is important if attached to a fixture or test stand. The round steel insert with a hole in the back of the housing is provided to withstand the load during a test. A mating dowel pin should be used (see illustration below). Mounting plates on Mark-10 test stands include a dowel pin and clearance holes for the four threaded holes located near the corners of the housing. An additional two holes are supplied for metric screws. These holes are designed to accommodate screws in order to hold the gauge in place (Mark-10 test stands include a set of thumb screws for gauge mounting). The screws must **not** be used for load bearing purposes. Failure to use a dowel pin properly can result in a hazardous situation.

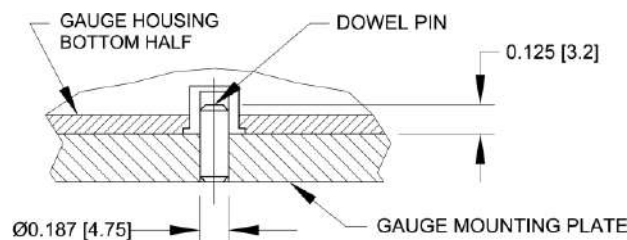

3.1.3 Mounting attachments to the gauge

The force gauge's threaded loading shaft is designed to accommodate common grips and attachments with female mounting holes. To mount a grip, gently thread it onto the shaft. Ensure that the grip or fixture is positioned to ensure axial load with respect to the loading shaft of the force gauge. When using a grip, ensure that it secures the sample in such a way that it is prevented from slipping out during a test, preventing a potential safety risk to the operator and others in the vicinity. If using a grip or fixture from a supplier other than Mark-10, ensure that it is constructed of suitably rugged materials and components.

Do not use jam nuts or tools to tighten grips or attachments onto the shaft. **Finger-tighten only.**

3.2 Installing the USB driver

If communicating via USB, install the USB driver available at:

Caution!

Install the USB driver before physically connecting the gauge to a PC with the USB cable.

Further instructions for configuring and using the gauge's outputs are provided in the **Communications and Outputs** section.

4 HOME SCREEN AND CONTROLS

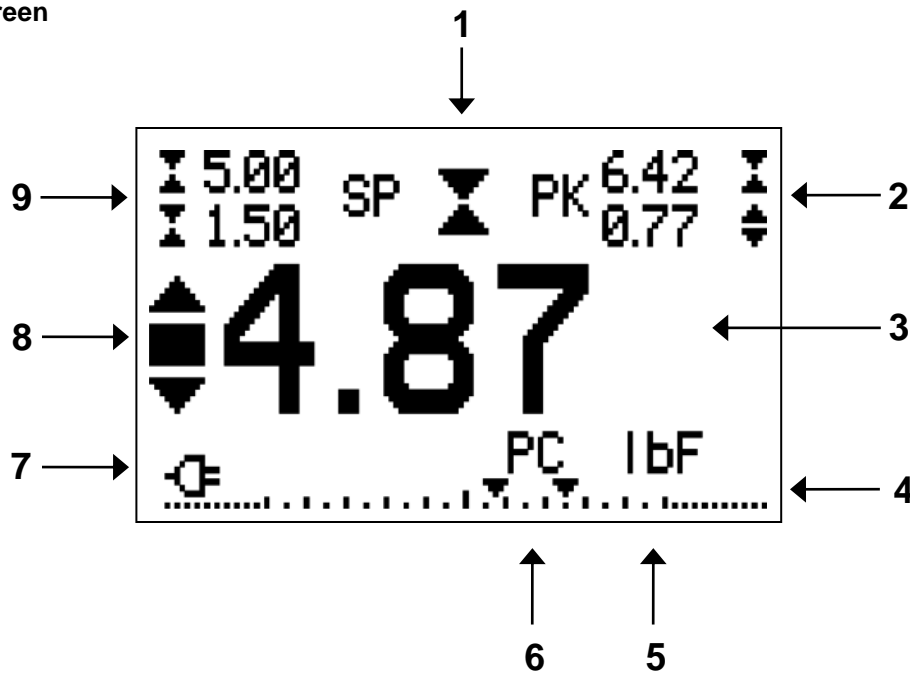

4.1 Home Screen



No.	Name	Description
1	Tension / compression indicator	<ul style="list-style-type: none"> ▲ - indicates a compression (push) direction ▼ - indicates a tension (pull) direction These indicators are used throughout the display and menu.
2	Peaks	The measured compression and tension readings. These readings are reset by pressing ZERO or by powering the gauge off and on.
3	Primary reading	The current displayed force reading. See Operating Modes section for details.
4	Load bar	Analog indicator to help identify when an overload condition is imminent. The bar increases either to the right or to the left from the midpoint of the graph. Increasing to the right indicates compression load, increasing to the left indicates tension load. If set points are enabled, triangular markers are displayed for visual convenience. This indicator reflects the actual load, which may not correspond to the primary reading (depends on operating mode). The ZERO key does not reset the load bar. See Operating Modes section for details.
5	Units	The current unit of measurement. Abbreviations are as follows: lbF – Pound-force

		kgF – Kilogram-force gF – Gram-force N – Newton Note: not all gauge capacities measure in all the above units. Refer to the capacity / resolution table in the Specifications section for details.
6	Mode	The current measurement mode. Abbreviations are as follows: RT – Real Time PC – Peak Compression PT – Peak Tension See Operating Modes section for details about each of these modes
7	Battery / AC adapter indicator	Either the AC adapter icon or battery power icon will be shown, depending on power conditions. Refer to the Power section for details.
8	High / low limit indicators	Correspond to the programmed set points. Indicator definitions are as follows: ▲ – the displayed value is greater than the upper force limit ■ – the displayed value is between the limits ▼ – the displayed value is less than the lower force limit
9	Set points	The programmed force limits. Typically used for pass/fail type testing. 1, 2, or no signals may be present, depending on the configuration shown in the Set Points menu item.

4.2 Controls

Primary Label	Primary Function	Secondary Label	Secondary Function
	Powers the gauge on and off. Press briefly to power on, press and hold to power off. Active only when the home screen is displayed.	ENTER	Various uses, as described in the following sections.
ZERO	Zeroes the primary reading and peaks.	 (UP)	Navigates up through the menu and sub-menus .
MENU	Enters the main menu.	ESCAPE	Reverts one step backwards through the menu hierarchy.
MODE	Toggles between measurement modes.	 (DOWN)	Navigates down through the menu and sub-menus.
DATA	Transmits the current reading to an external device, via the USB port.	DIRECTION	Reverses the display during calibration, and toggles between tension and compression directions while configuring set points and other menu items.

Note: Measurement units are configured through the menu. Refer to the **Changing The Units** section for details.

4.3 Menu navigation basics

Most of the gauge's various functions and parameters are configured through the main menu. To access the menu press **MENU**. Use the **UP** and **DOWN** keys to scroll through the items. The current selection is denoted with clear text over a dark background. Press **ENTER** to select a menu item, then use **UP** and **DOWN** again to scroll through the sub-menus. Press **ENTER** again to select the sub-menu item.

For parameters that may be either selected or deselected, press **ENTER** to toggle between selecting and deselecting. An asterisk (*) to the left of the parameter label is used to indicate when the parameter has been selected.

For parameters requiring the input of a numerical value, use the **UP** and **DOWN** keys to increment or decrement the value. Press and hold either key to auto-increment at a gradually increasing rate. When

the desired value has been reached, press **ENTER** to save the change and revert back to the sub-menu item, or press **ESCAPE** to revert back to the sub-menu item without saving. Press **ESCAPE** to revert one step back in the menu hierarchy until back into normal operating mode.

Refer to the following sections for details about setting up particular functions and parameters.

5 OPERATING MODES

Caution!

In any operating mode, if the capacity of the instrument has been exceeded by more than 110%, the display will show "OVER" to indicate an overload. A continuous audible tone will be sounded (if beeps are enabled) until the MENU key has been pressed or the load has been reduced to a safe level.

Three operating modes are possible with Series 3 gauges. To cycle between the modes, press **MODE** while in the home screen.

5.1 Real time (RT)

The primary reading corresponds to the live measured reading.

5.2 Peak Compression (PC)

The primary reading corresponds to the peak compression reading observed. If the actual force decreases from the peak value, the peak will still be retained in the primary reading area of the display. Pressing **ZERO** will reset the value.

5.3 Peak Tension (PT)

Same as Peak Compression, but for tension readings.

6 CHANGING THE UNITS

Series 3 gauges display one of three measurement units. To change the unit, select **Units** from the menu. The display appears as follows:

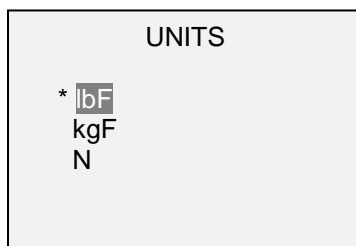

The gauge will always power on with the unit selected.

7 DIGITAL FILTERS

Digital filters are provided to help smooth out the readings in situations where there is mechanical interference in the work area or test sample. These filters utilize the moving average technique in which consecutive readings are pushed through a buffer and the displayed reading is the average of the buffer contents. By varying the length of the buffer, a variable smoothing effect can be achieved. The selection of 1 will disable the filter since the average of a single value is the value itself.

To access digital filter settings, select **Filters** from the menu. The display appears as follows:

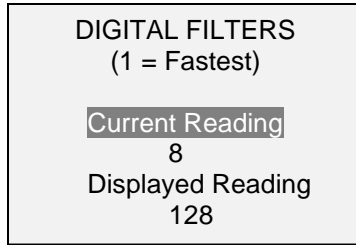

Two filters are available:

Current Reading – Applies to the peak capture rate of the instrument.

Displayed Reading – Applies to the primary reading on the display.

Available settings: 1,2,4,8,16,32,64,128,256,512,1024. It is recommended to keep the current reading filter at its lowest value for best performance, and the displayed reading filter at its highest value for best visual stability.

8 SET POINT INDICATORS

8.1 General Information

Set points are useful for tolerance checking (pass/fail). Two limits, high and low, are specified and stored in the non-volatile memory of the instrument and the primary reading is compared to these limits.

8.2 Configuration

To configure set points, select **Set Points** from the menu. The screen appears as follows:

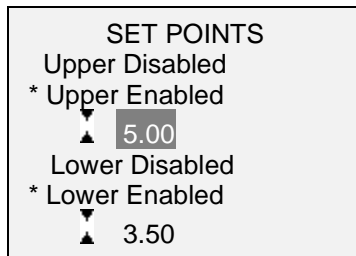

Either one, two, or none of the set points may be enabled. To toggle between the tension and compression directions, press the **DIRECTION** key.

If two set points have been enabled, they are displayed in the upper left corner of the display. If only one set point has been enabled, the word "OFF" appears in place of the value. If no set points have been enabled, the upper left corner of the display will be blank.

When set points are enabled, the following indicators are shown to the left of the primary reading:

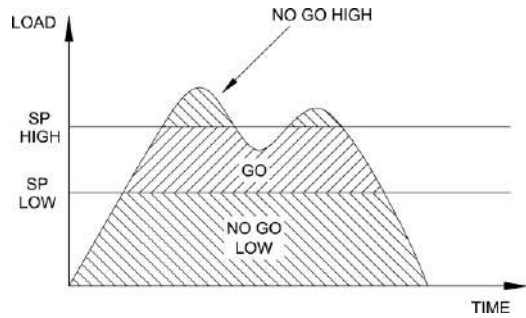

- ▲ – the displayed value is greater than the upper force limit (NO GO HIGH)
- – the displayed value is between the limits (GO)
- ▼ – the displayed value is less than the lower force limit (NO GO LOW)

Note: Set point indicators reference the displayed reading, not necessarily the current live load.

9 COMMUNICATIONS AND OUTPUTS

9.1 Communication Settings

To set up communication settings, select **USB Settings** from the menu. The screen appears as follows:

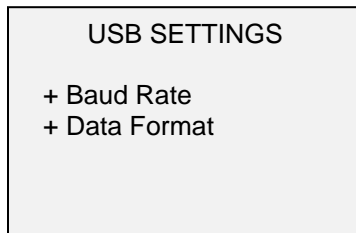

Communication settings are permanently set to the following:

Data Bits: 8
Stop Bits: 1
Parity: None

Other settings are configured as follows:

9.1.1 Baud Rate

Select the baud rate as required for the application. It must be set to the same value as the receiving device.

9.1.2 Data Format

Select the desired data format. The screen appears as follows:

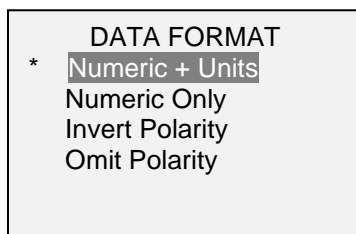

Selection	Description
Numeric + Units	Output format includes the value and unit of measure. Compression values have positive polarity, tension values have negative polarity.
Numeric Only	Output format includes the value only. Polarity same as above.
Invert Polarity	Compression values have negative polarity, tension values have positive polarity. May be selected in addition to the Numeric + Units / Numeric Only selection.
Omit Polarity	Both directions are formatted with positive polarity. May be selected in addition to the Numeric + Units / Numeric Only selection.

9.2 Data Output

Communication with Series 3 gauges is achieved through the micro USB port located along the left side of the housing, as shown in the illustration in the **Power** section. Communication is possible only when the gauge is in the main operating screen (i.e. not in a menu or configuration area).

The current reading is transmitted from the gauge when the **DATA** key is pressed. The gauge may also be controlled by an external device through the USB channel by sending ASCII command '?' (no quotes). The command must be terminated by a CR (Carriage Return) character, 0x0D, or a CR-LF (Carriage Return – Line Feed) pair, where the Line Feed, 0x0A, is ignored.

9.3 Command Responses

In response to the reading request command '?' the gauge will return a string with the load data, followed by a space, then the load unit (if enabled under the **USB Settings** → **Data format** sub-menu). It will be terminated by a CR-LF pair.

Example return strings:

```
-18.78 lbF<CR><LF>    18.78 lbF of tension force
 1.724 N<CR><LF>      1.724 N of compression force
```

The number of digits after the decimal point is dependent of the gauge's capacity and resolution.

By default, the minus sign (-) indicates tension, and the absence of a sign indicates compression. However, positive / negative polarity may be inverted or omitted under the **USB Settings** → **Data Format** sub-menu.

Any detected errors are reported back by means of error code *10 (illegal command).

The gauge can send individual data points or continuous data to *MESUR[®]gauge* and *MESUR[®]Lite* software.

10 CALIBRATION

10.1 Initial Physical Setup

The gauge should be mounted vertically to a test stand or fixture rugged enough to withstand a load equal to the full capacity of the instrument. Certified deadweights or master load cells should be used, along with appropriate mounting brackets and fixtures. Caution should be taken while handling such equipment.

10.2 Calibration Procedure

1. Select **Calibration** from the menu. The display appears as follows:

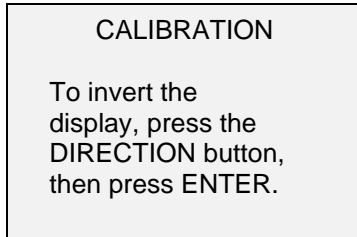

2. Press **DIRECTION** to invert the display, if desired. **ENTER** to continue. The display appears as follows:

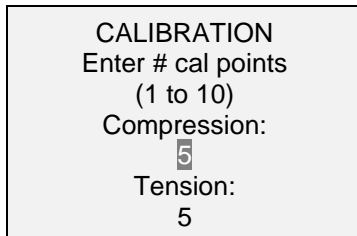

The gauge can be calibrated at up to 10 points in each direction. Enter the number of calibration points for each direction (compression and tension). At least one point must be selected for each direction.

Note: To achieve the accuracy specification of $\pm 0.3\%$, it is recommended to calibrate the gauge at 5 or more even increments in both tension and compression directions. For example, a gauge with capacity of 10 lbF should be calibrated at 2, 4, 6, 8, and 10 lb loads in each direction.

3. To escape the **Calibration** menu at any time, press **ESCAPE**. The display appears as follows:

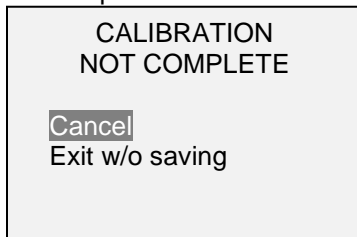

Selecting "Cancel" will revert back to the Calibration setup. Selecting "Exit w/o saving" will return to the menu without saving changes.

4. After the number of calibration points has been entered, press **ENTER**. The display appears as follows:

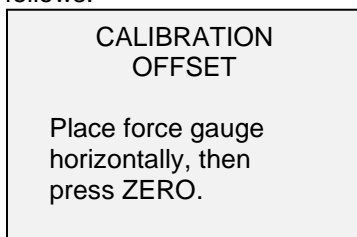

5. Place the force gauge horizontally on a level surface free from vibration, then press **ZERO**. The gauge will calculate internal offsets, and the display appears as follows:

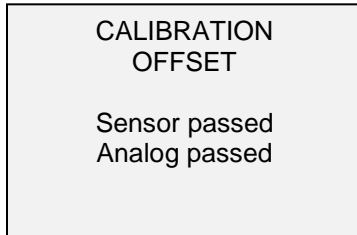
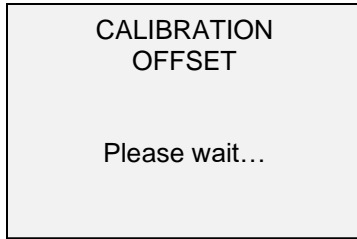

If failed:

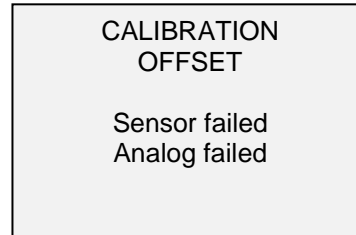

6. The following screen appears after the offsets have been calculated:



Attach weight fixtures (brackets, hooks, etc), as required. Do not yet attach any weights or apply any calibration loads. Press **ENTER**.

7. The display appears as follows:

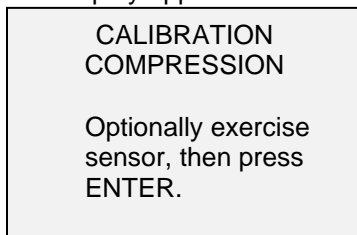

Optionally exercise the load cell shaft several times (at full scale, if possible), then press **ENTER**.

8. The display appears as follows:



Apply a weight equal to the full scale of the instrument, then press **ENTER**.

9. After displaying "Please wait..." the display appears as follows:



Remove the load applied in Step 8, leave the fixtures in place, then press **ZERO**.

10. The display appears as follows:



Use the **UP** and **DOWN** keys to adjust the load value as required. The load values default to even increments, as indicated by the previously entered number of data points (even increments are recommended for best results). For example, if a 50 lbF capacity gauge is calibrated, and 5 data points were selected, the load values will default to 10, 20, 30, 40, and 50 lb. Apply the calibration load. Then press **ENTER**.

Repeat the above step for the number of data points selected.

11. After all the compression calibration points have been completed, the display appears as follows:



Press **ENTER**.

12. The display appears as follows:

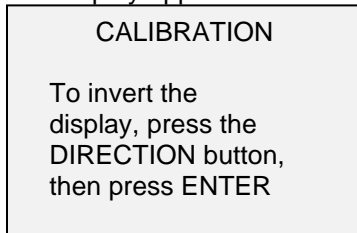

Reverse the orientation of the load cell shaft by rotating the gauge 180 degrees. Press **DIRECTION** to invert the display. Then attach weight fixtures. The following screens will step through the same procedure as with the compression direction. Proceed in the same manner.

13. At the completion of the tension calibration, the display appears as follows:

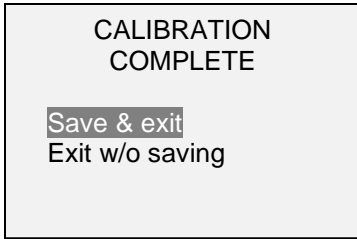

To save the calibration information, select "Save & exit". To exit without saving the data select "Exit without saving".

14. Any errors are reported by the following screens:



Displayed at the start of calibration if a disallowed unit is selected.



Ensure that the load is not swinging, oscillating, or vibrating in any manner. Then try again.

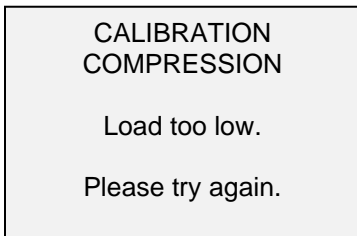

The calibration weight does not match the set value.

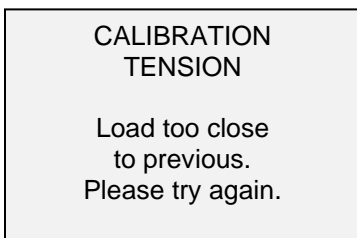

The entered calibration point is too close to the previous point.

11 OTHER SETTINGS

11.1 Automatic Shutoff

The gauge may be configured to automatically power off following a period of inactivity while on battery power. Inactivity is defined as the absence of any key presses or load changes of 100 counts or less. To access these settings, select **Automatic Shutoff** from the menu. The display appears as follows:



Selection	Description
Disabled	Disable automatic shutoff.
Enabled	Enable automatic shutoff.
Set Minutes	The length of time of inactivity. Available settings: 5-30, in 5 minute increments.

Note: If the AC adapter is plugged in, the gauge will ignore these settings and remain powered on until the **POWER** key is pressed.

11.2 Backlight

Several initial settings are available, upon powering on the gauge. To access these settings, select **Backlight** from the menu. The display appears as follows:



Selection	Description
Off	Backlight to be off upon powering on the gauge.
On	Backlight to be on upon powering on the gauge.
Auto	Backlight to be on upon powering gauge, but will shut off after a period of inactivity (as defined in the Automatic Shutoff sub-section). The backlight will turn on again when activity resumes. The length of time of inactivity is programmed in minutes via the Set Minutes parameter. Available settings: 1-10, in 1 minute increments.

Note: If the AC adapter is plugged in, the gauge will ignore these settings and keep the backlight on. Selecting the **On** or **Off** setting in the **Backlight** menu will manually turn the backlight on or off as if the Backlight key were pressed.

11.3 LCD Contrast

The contrast of the display may be adjusted. Select **LCD Contrast** from the menu. The screen appears as follows:



Press **ENTER** to modify the contrast. Select a value from 0 to 25, 25 producing the most contrast.

11.4 Tones

Audible tones can be enabled for all key presses and alerts, such as overload, set point value reached, etc. The Set Point alert can be configured to be either a momentary tone or a continuous tone (until the load is restored to a value between the set points). To configure the functions for which audible tones will apply, select **Tones** from the menu. The screen appears as follows:

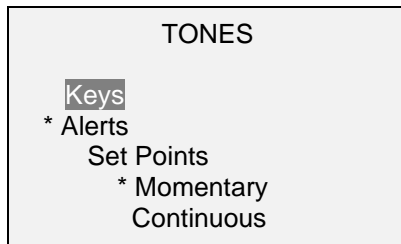

11.5 Initial Mode

This section is used to configure the initial mode upon powering on the gauge. To access this parameter, select **Initial Mode** from the menu. The screen appears as follows:

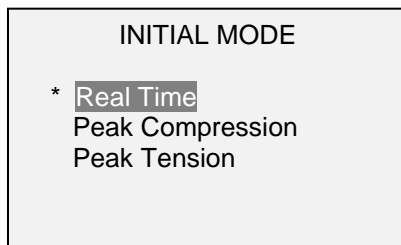

The default value is Real Time.

11.6 Restore Default Settings

Default factory settings can be restored by selecting **Restore Defaults** from the menu. The settings may be found in the **Specifications** section. The screen appears as follows:

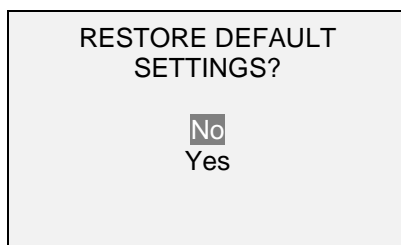

11.7 Information / Welcome Screen

The following screen is displayed at power up and can be accessed at any time by selecting **Information** from the menu:

Digital Force Gauge Series 3 Model No: M3-50 Serial No: 1234567 Version: 1.0 (c) Mark-10 Corp.

12 SPECIFICATIONS

12.1 General

Accuracy:	±0.3% of full scale
Sampling rate:	2,000 Hz
Power:	AC or rechargeable battery. Low battery indicator appears when battery level is low, and gauge powers off automatically when power reaches critical stage.
Battery life:	Backlight on: up to 7 hours of continuous use Backlight off: up to 24 hours of continuous use
Measurement units:	lbF, gF, kgF, N (depending on model)
Safe overload:	200% of full scale (display shows "OVER" at 110% and above)
Weight (gauge only):	M3-012 – M3-100: 0.7 lb [0.33 kg] M3-200 – M3-500: 0.9 lb [0.41 kg]
Included accessories:	Carrying case, chisel, cone, V-groove, hook, flat, extension rod, AC adapter, battery, USB cable, NIST-traceable certificate of calibration
Environmental requirements:	40 - 100°F, max. 93% humidity, non-condensating
Warranty:	3 years (see individual statement for further details)
Literature & Software:	_____

12.2 Factory Settings

Parameter	Setting
Set points	
Upper	Disabled (defaults to 80% of full scale, compression, when enabled)
Lower	Disabled (defaults to 40% of full scale, compression, when enabled)
Filters	
Current	8
Displayed	128
Backlight	Auto
Minutes	1
USB Output	Disabled
Baud Rate	9,600
Data Format	Numeric + units
Automatic Shutoff	Enabled
Minutes	5
Tones	
Keys	Enabled
Alerts	Enabled
Set Points	Momentary
Initial Mode	Real Time
Units	lbf

12.3 Capacity, Resolution & Load Cell Deflection

Model	lbf	kgF	gF	N	Load Cell Deflection in [mm]
M3-012	0.12 x 0.0001	-	50 x 0.05	0.5 x 0.0005	0.005 [0.13]
M3-025	0.25 x 0.0002	-	100 x 0.1	1 x 0.001	0.010 [0.25]
M3-05	0.5 x 0.0005	-	250 x 0.2	2.5 x 0.002	0.010 [0.25]
M3-2	2 x 0.002	1 x 0.001	-	10 x 0.01	0.010 [0.25]
M3-5	5 x 0.005	2.5 x 0.002	-	25 x 0.02	0.010 [0.25]
M3-10	10 x 0.01	5 x 0.005	-	50 x 0.05	0.010 [0.25]
M3-20	20 x 0.02	10 x 0.01	-	100 x 0.1	0.010 [0.25]
M3-50	50 x 0.05	25 x 0.02	-	250 x 0.2	0.010 [0.25]
M3-100	100 x 0.1	50 x 0.05	-	500 x 0.5	0.010 [0.25]
M3-200	200 x 0.2	100 x 0.1	-	1000 x 1	0.010 [0.25]
M3-500	500 x 0.5	250 x 0.2	-	2500 x 2	0.010 [0.25]

12.4 Dimensions

IN [MM]

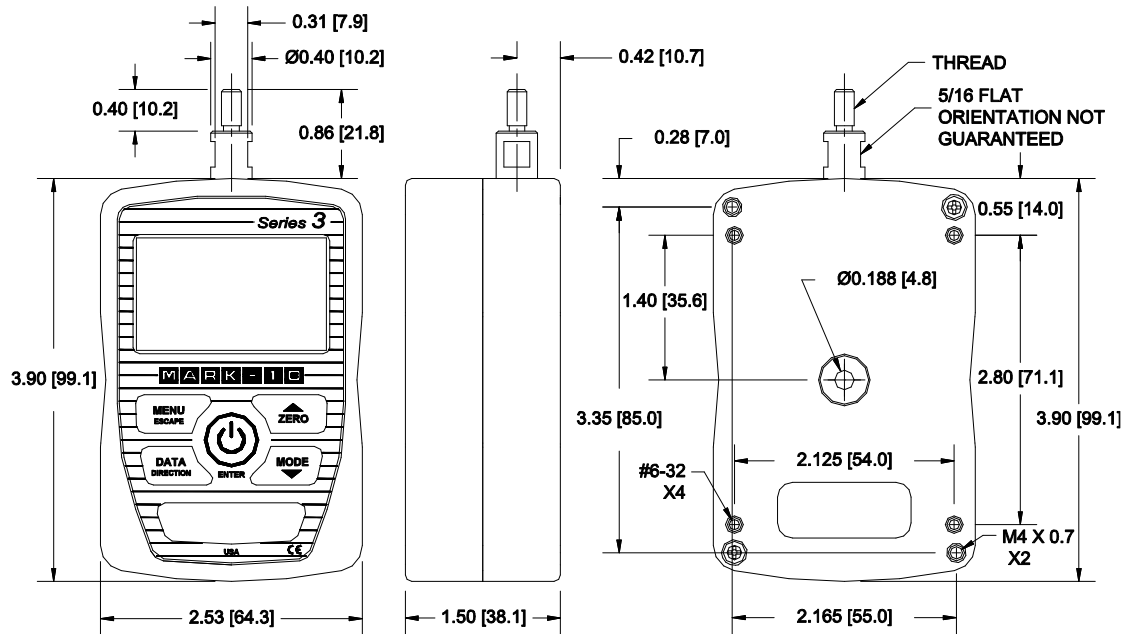

	Thread	Flat
M3-012 – M3-100	#10-32 UNF	5/16 [7.94]
M3-200 – M3-500	5/16-18 UNC	5/16 [7.94]