

# EZ-ZONE<sup>®</sup> PM

## User's Guide



## PID Controller Models



# WATLOW<sup>®</sup>

*Powered by Possibility*



**ISO 9001**



Registered Company  
Winona, Minnesota USA

0600-0058-0000 Rev. P



August 2016

Made in the U.S.A.

Find Quality Products Online at:









[www.GlobalTestSupply.com](http://www.GlobalTestSupply.com)

[sales@GlobalTestSupply.com](mailto:sales@GlobalTestSupply.com)

## Safety Information

We use note, caution and warning symbols throughout this book to draw your attention to important operational and safety information.

- A “NOTE” marks a short message to alert you to an important detail.
- A “CAUTION” safety alert appears with information that is important for protecting your equipment and performance. Be especially careful to read and follow all cautions that apply to your application.
- A “WARNING” safety alert appears with information that is important for protecting you, others and equipment from damage. Pay very close attention to all warnings that apply to your application.
- The electrical hazard symbol, ⚡ (a lightning bolt in a triangle) precedes an electric shock hazard CAUTION or WARNING safety statement.

Symbol	Explanation
	CAUTION - Warning or Hazard that needs further explanation than label on unit can provide. Consult User's Guide for further information.
	ESD Sensitive product, use proper grounding and handling techniques when installing or servicing product.
	Unit protected by double/reinforced insulation for shock hazard prevention.
	Do not throw in trash, use proper recycling techniques or consult manufacturer for proper disposal.
	Enclosure made of Polycarbonate material. Use proper recycling techniques or consult manufacturer for proper disposal.
	Unit can be powered with either alternating current (ac) voltage or direct current (dc) voltage.
	Unit is a Listed device per Underwriters Laboratories®. It has been evaluated to United States and Canadian requirements for Process Control Equipment. UL 61010 and CSA C22.2 No. 61010. File E185611 QUYY, QUYY7. See: <a href="http://www.ul.com">www.ul.com</a>
	Unit is a Listed device per Underwriters Laboratories®. It has been evaluated to United States and Canadian requirements for Hazardous Locations Class 1 Division II Groups A, B, C and D. ANSI/ISA 12.12.01-2007. File E184390 QUZW, QUZW7. See: <a href="http://www.ul.com">www.ul.com</a>
	Unit is compliant with European Union directives. See Declaration of Conformity for further details on Directives and Standards used for Compliance.

	Unit has been reviewed and approved by Factory Mutual as a Temperature Limit Device per FM Class 3545 standard. See: <a href="http://www.fmglobal.com">www.fmglobal.com</a>
	Unit has been reviewed and approved by CSA International for use as Temperature Indicating-Regulating Equipment per CSA C22.2 No. 24. See: <a href="http://www.csa-international.org">www.csa-international.org</a>
	Unit has been reviewed and approved by ODVA for compliance with DeviceNet communications protocol. See: <a href="http://www.odva.org">www.odva.org</a>
	Unit has been reviewed and approved by ODVA for compliance with Ethernet/IP communications protocol. See: <a href="http://www.odva.org">www.odva.org</a>

---

## Warranty

The EZ-ZONE® PM is manufactured by ISO 9001-registered processes and is backed by a three-year warranty to the first purchaser for use, providing that the units have not been misapplied. Since Watlow has no control over their use, and sometimes misuse, we cannot guarantee against failure. Watlow's obligations hereunder, at Watlow's option, are limited to replacement, repair or refund of purchase price, and parts which upon examination prove to be defective within the warranty period specified. This warranty does not apply to damage resulting from transportation, alteration, misuse or abuse. The purchaser must use Watlow parts to maintain all listed ratings.

---



---

## Return Material Authorization (RMA)

1. \_\_\_\_\_ for a Return Material Authorization (RMA) number before returning any item for repair. If you do not know why the product failed, contact an Application Engineer or Product Manager. All RMA's require:
  - Ship-to address
  - Bill-to address
  - Contact name
  - Phone number
  - Method of return shipment

- Your P.O. number
  - Detailed description of the problem
  - Any special instructions
  - Name and phone number of person returning the product.
2. Prior approval and an Return Merchandise Authorization number from the Customer Service Department is required when returning any product for credit, repair or evaluation. Make sure the Return Merchandise Authorization number is on the outside of the carton and on all paperwork returned. Ship on a Freight Prepaid basis.
  3. After we receive your return, we will examine it and try to verify the reason for returning it.
  4. In cases of manufacturing defect, we will enter a repair order, replacement order or issue credit for material returned. In cases of customer misuse, we will provide repair costs and request a purchase order to proceed with the repair work.
  5. To return products that are not defective, goods must be in new condition, in the original boxes and they must be returned within 120 days of receipt. A 20 percent restocking charge is applied for all returned stock controls and accessories.
  6. If the unit cannot be repaired, you will receive a letter of explanation and be given the option to have the unit returned to you at your expense or to have us scrap the unit.
  7. Watlow reserves the right to charge for no trouble found (NTF) returns.

This EZ-ZONE® PM User's Guide is copyrighted by Watlow Electric, Inc., © August 2016 with all rights reserved.

EZ-ZONE PM is covered by U.S. Patent Numbers: 6005577; D553095; D553096; D553097; D560175; D55766; and OTHER PATENTS PENDING



# Table of Contents

- Table of Contents . . . . . 1**
- Chapter 1: Overview . . . . . 5**
  - Available EZ-ZONE PM Literature and Resources . . . . . 5
  - Introduction . . . . . 6
  - Getting Started Quickly . . . . . 7
  - A Conceptual View of the PM . . . . . 8
    - Inputs . . . . . 8
    - Internal Functions . . . . . 9
    - Outputs . . . . . 9
    - Input Events and Output Events . . . . . 9
    - What is a Profile . . . . . 9
- Chapter 2: Install and Wire . . . . . 11**
  - Dimensions . . . . . 11
    - 1/32 DIN . . . . . 11
    - 1/16 DIN . . . . . 12
    - 1/8 DIN (PM8) Vertical . . . . . 13
    - 1/8 DIN (PM8) Vertical Recommended Panel Spacing . . . . . 13
    - 1/8 DIN (PM9) Horizontal . . . . . 14
    - 1/8 DIN (PM9) Horizontal Recommended Panel Spacing . . . . . 14
    - 1/4 DIN (PM4) . . . . . 15
    - 1/4 DIN (PM4) Recommended Panel Spacing . . . . . 15
  - Installation . . . . . 16
  - Wiring . . . . . 18
  - EZ-ZONE PM Isolation Blocks . . . . . 20
- Chapter 3: Keys and Displays . . . . . 34**
  - Responding to a Displayed Message . . . . . 35
- Chapter 4: Home Page . . . . . 36**
  - Default Home Page Parameters . . . . . 36
    - Navigating the EZ-ZONE® PM PID Controller . . . . . 37
    - Changing the Set Point . . . . . 37
    - Starting a Profile from the Home Page . . . . . 38
    - Modifying the Display Pairs . . . . . 40
    - Conventions Used in the Menu Pages . . . . . 41
    - Display . . . . . 42
    - Range . . . . . 42
    - Modbus RTU Protocols . . . . . 42



# Table of Contents (cont.)

<b>Chapter 5: Operations Page</b> .....	<b>44</b>
Analog Input Menu .....	46
Linearization Menu .....	47
Process Value Menu .....	48
Digital Input/Output Menu .....	48
Monitor Menu .....	49
Control Loop Menu .....	50
Alarm Menu .....	53
Timer Menu .....	55
Profile Status Menu .....	57
<b>Chapter 6: Setup Page</b> .....	<b>60</b>
Analog Input Menu .....	63
Linearization Menu .....	66
Process Value Menu .....	69
Digital Input/Output Menu .....	70
Control Loop Menu .....	74
Output Menu .....	81
Alarm Menu .....	84
Timer Menu .....	89
Function Key .....	91
Global Menu .....	93
Communications Menu .....	96
Real Time Clock Menu .....	98
<b>Chapter 7: Profiling Page</b> .....	<b>99</b>
Profile Setup .....	99
Profiling Menu .....	104
<b>Chapter 8: Factory Page</b> .....	<b>110</b>
Custom .....	111
Lock Menu .....	112
Unlock Menu .....	114
Diagnostics Menu .....	115
Calibration Menu .....	116
<b>Chapter 9: Features</b> .....	<b>119</b>
Changing PM Integrated Model Number to PM Express .....	121
Saving and Restoring Settings .....	122
Programming the Home Page .....	123



# Table of Contents (cont.)

Tuning the PID Parameters .....	123
Autotune .....	123
Manual Tuning .....	124
Autotuning with TRU-TUNE+® .....	125
Inputs .....	126
Calibration Offset .....	126
Calibration .....	126
Filter Time Constant .....	128
Sensor Selection .....	128
Set Point Minimum and Maximum .....	128
Scale High and Scale Low .....	128
Range High and Range Low .....	129
Ten Point Linearization .....	129
Outputs .....	129
Duplex .....	129
NO-ARC Relay .....	130
Retransmitting a Process Value or Set Point .....	130
Cool Output Curve .....	131
Control Methods .....	131
Output Configuration .....	131
Auto (closed loop) and Manual (open loop) Control .....	132
On-Off Control .....	133
Proportional and (P) Control .....	133
Proportional and Integral (PI) Control .....	134
Proportional, Integral and Derivative (PID) Control .....	134
Dead Band .....	134
Variable Time Base .....	135
Single Set Point Ramping .....	136
Timer Function .....	137
Setting Up the Timer Function .....	138
Alarms .....	140
Process and Deviation Alarms .....	140
Set Points .....	140
Hysteresis .....	140
Latching .....	141
Silencing .....	141
Blocking .....	141



# Table of Contents (cont.)

- Open Loop Detection ..... 141
- Using Lockout and Password Security ..... 142
  - Using Lockout Method 2 (Password Enable) ..... 144
- Modbus - Using Programmable Memory Blocks..... 146
- Software Configuration ..... 147
  - Using EZ-ZONE Configurator Software..... 147
- Chapter 10: Appendix ..... 151**
  - Troubleshooting Alarms, Errors and Control Issues ..... 151
  - Modbus - Programmable Memory Blocks..... 157
  - PM Specifications ..... 160
  - Ordering Information for PID Controller Models ..... 166
  - How to Reach Us..... 168



# 1

## Chapter 1: Overview

### Available EZ-ZONE PM Literature and Resources

Document Title and Part Number	Description
EZ-ZONE PM Integrated PID Controller User's Guide, part number: 0600-0059-0000	Describes how to connect and use an advanced PID loop controller. This particular model can be ordered with two loops of PID control and integrated limit controller with up to 4 outputs. Like all PM controllers, it comes with Standard Bus communications while also offering as an option many of the most popular industrial protocols available today.
EZ-ZONE PM Limit (PML) User's Guide, part number: 0600-0057-0000	This document describes how to protect against unwanted thermal runaway and over temperature conditions through proper configuration, programming. Like all PM controllers, it comes with Standard Bus communications. As an additional option, it can also be ordered with various fieldbus communications protocols.
EZ-ZONE Remote User Interface (RUI) User's Guide, part number: 0600-0060-0000	The RUI provides a visual remote LED display for the PM/RM configuration and setup menus. This document illustrates and describes connections and also describes the Home Page for each EZ-ZONE device as viewed from the RUI.
EZ-ZONE PM Specification Sheet, part number: wine-zpm0516	Describes the PM family hardware options, features, benefits and technical specifications.
Watlow Support Tools DVD, part number: 0601-0001-0000	Contains all related user documents, tutorial videos, application notes, utility tools, etc...

The DVD described above ships with the product and as stated contains all of the literature above as well as much more. If the DVD is not available one can be acquired by contacting

## Introduction

The EZ-ZONE® PM takes the pain out of solving your thermal loop requirements. Watlow's EZ-ZONE PM controllers offer options to reduce system complexity and the cost of control loop ownership. You can order the EZ-ZONE PM as a PID controller or an over-under limit controller, or you can combine both functions in the PM Integrated Controller. You now have the option to integrate a high-amperage power controller output, an over-under limit controller and a high-performance PID controller all in space saving, panel-mount packages. You can also select from a number of industrial serial communications options to help you manage system performance.

---

### Standard Features and Benefits

#### Advanced PID Control Algorithm

- TRU-TUNE+® Adaptive tune provides tighter control for demanding applications.
- Auto Tune for fast, efficient start ups

#### High-amperage Power Control Output

- Drives 15 amp resistive loads directly
- Reduces component count
- Saves panel space and simplifies wiring
- Reduces the cost of ownership

#### EZ-ZONE configuration communications and software

- Saves time and improves the reliability of controller set up

#### Parameter Save & Restore Memory

- Reduces service calls and down time

#### Agency approvals: UL Listed, CSA, CE, RoHS, W.E.E.E. FM

- Assures prompt product acceptance
- Reduces end product documentation costs
- Semi F47-0200

#### P3T Armor Sealing System

- NEMA 4X and IP65 offers water and dust resistance, can be cleaned and washed down (indoor use only)
- Backed up by UL 50 independent certification to NEMA 4X specification

#### Three-year warranty

- Demonstrates Watlow's reliability and product support

#### Touch-safe Package

- IP2X increased safety for installers and operators

#### Removable cage clamp wiring connectors

- Reliable wiring, reduced service calls
- Simplified installation

#### EZ-Key/s

- Programmable EZ-Key enables simple one-touch operation of repetitive user activities

## Programmable Menu System

- Reduces set up time and increases operator efficiency

## Full-featured Alarms

- Improves operator recognition of system faults
- Control of auxiliary devices

## Heat-Cool Operation

- Provides application flexibility with accurate temperature and process control

## Profile Capability

- Pre-programmed process control
- Ramp and soak programming with four files and 40 total steps

---

## Getting Started Quickly

The PM control has a page and menu structure that is listed below along with a brief description of its purpose.

<b>Setup Page</b> Push and hold the up and down keys (▲ ▼) for 6 seconds to enter. (See the <a href="#">Setup Page</a> for further information)	Once received, a user would want to setup their control prior to operation. As an example, define the input type and set the output cycle time.
<b>Operations Page</b> Press and hold the up and down keys (▲ ▼) for 3 seconds to enter. (See the <a href="#">Operations Page</a> for further information)	After setting up the control to reflect your equipment, the Operations Page would be used to monitor or change runtime settings. As an example, the user may want to see how much time is left in a profile step or perhaps change the high set point of the limit.
<b>Factory Page</b> Press and hold the Infinity and the green Advance Keys (∞ ⌂) for 6 seconds to enter. (See the <a href="#">Factory Page</a> for further information)	For the most part the Factory Page has no bearing on the control when running. A user may want to enable password protection, view the control part number or perhaps create a custom Home Page.
<b>Home Page</b> The control is at the <a href="#">Home Page</a> when initially powered up.	Pushing the green Advance Key ⌂ will allow the user to see and change such parameters as the control mode, enable autotune and idle set point, to name a few.
<b>Profile Page</b> Press and hold the green Advance Key ⌂ for 6 seconds to enter. (See the <a href="#">Profile Page</a> for further information)	If equipped with this feature a user would want to go here to configure a profile.

The default PM loop configuration from the factory is shown below:

- Analog Input functions set to thermocouple, type J
- Heat algorithm set for PID, Cool set to off
- Output 1 set to Heat
- Control mode set to Auto
- Set point set to 75 °F

If you are using the input type shown above, simply connect your input and output devices to the control. Power up the control and push the up arrow  on the face of the control to change the set point from the default value of 75° F to the desired value. As the Set Point increases above the Process Value, output 1 will come on and it will now begin driving your output device. The PV function as shown in the graphic below is only available with PM4/8/9 models.

**Note:**

The output cycle time will have a bearing on the life of mechanical relay outputs and can be different based on the type of output ordered. The output cycle time can be changed in the Setup Page under the Output Menu.

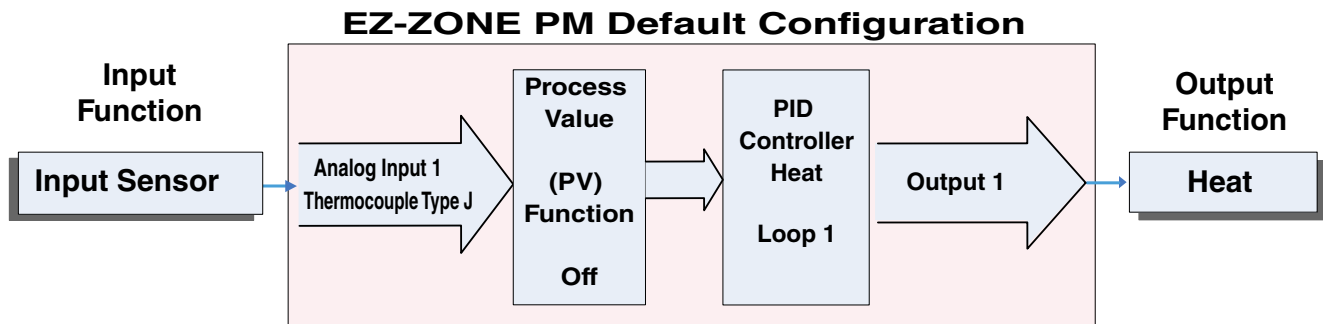

## A Conceptual View of the PM

The flexibility of the PM's software and hardware allows a large range of configurations. Acquiring a better understanding of the controller's overall functionality and capabilities while at the same time planning out how the controller can be used will deliver maximum effectiveness in your application.

It is useful to think of the controller in three parts: inputs; procedures; and outputs. Information flows from an input to a procedure to an output when the controller is properly configured. A single PM controller can carry out several procedures at the same time, for instance closed-loop control, monitoring for several different alarm situations and operating switched devices, such as lights and motors. Each process needs to be thought out carefully and the controller's inputs, procedures and outputs set up properly.

### Inputs

The inputs provide the information that any given programmed procedure can act upon. In a simple form, this information may come from an operator pushing a button or from a sensor monitoring the temperature of a part being heated or cooled.

Each analog input typically uses a thermocouple or RTD to read the process temperature. It can also read volts, current or resistance, allowing it to use various devices to read a wide array of values.

A PM with digital input/output (DIO) hardware includes two sets of terminals where each of which can be used as either an input or an output. Each pair of terminals must be configured to function as either an input or output with the direction parameter in the Digital Input/Output Menu (Setup Page). Each digital input reads whether a device is active or inactive.

The Function or EZ Key/s (PM4/6/8/9 only) on the front panel of the PM also operates as a digital input by toggling the function assigned to it in the Digital Input Function parameter in the Function Key Menu (Setup Page).

## Internal Functions

The controller will use input signals to calculate a value and then perform an operation. A sample of some functions may be as simple as:

- Compare an input value to the set point and calculate the optimal power for a heater
- Detect a failure of the primary sensing device and trip a contactor to remove power from the heating element
- Reading a digital input to set a state to true or false
- Evaluate an incoming temperature to determine an alarm state (on or off)

To set up a function, it's important to define the source, or instance, to use. For example, if the control is equipped with DIO they can be configured to respond to an alarm. If configured as such, the digital output must be tied to the desired alarm instance (1 to 4). Using this as an example, the Function for the digital output would be defined as an Alarm where the Instance would be selected as 1, 2, 3, or 4 corresponding to the alarm instance that will drive the output.

Keep in mind that a function is a user-programmed internal process that does not execute any action outside of the controller. To have any effect outside of the controller, an output must be configured to respond to a function..

---

## Outputs

Outputs can perform various functions or actions in response to information provided by a function such as, removal of the control voltage to a contactor; operating a heater, turning a light on or off, unlocking a door, etc...

Assign a Function to any available output on the Setup Page within the Output Menu or Digital Input/Output Menu. Then select which instance of that function will drive the selected output. For example, you might assign an output to respond to alarm 4 (instance 4).

You can assign more than one output to respond to a single instance of a function. For example, alarm 2 could be used to trigger a light connected to output 1 and a siren connected to digital output 5.

---

## Input Events and Output Events

Input and output events are internal states that are used exclusively by profiles. The source of an event input can come from a real-world digital input or an output from another function. Likewise, event outputs may control a physical output such as an output function block or be used as an input to another function.

---

## What is a Profile

A profile is a set of instructions consisting of a sequence of steps. When a profile runs, the controller automatically executes its steps in sequence. The step type determines what action the controller performs. Steps can change temperatures and other process values gradually over time, maintain the temperatures and process values for specific periods, or repeat a sequence of steps numerous times. At each step the profile can activate or deactivate outputs that control other equipment. Also a step can have the controller wait for specific conditions before proceeding such as, waiting for a switch closure and/or a specific process value to be detected by a sensor.

# EZ-ZONE® PM PID Model System Diagram

Universal Sensor Input, Configuration Communications,  
Red/Green 7-Segment Display

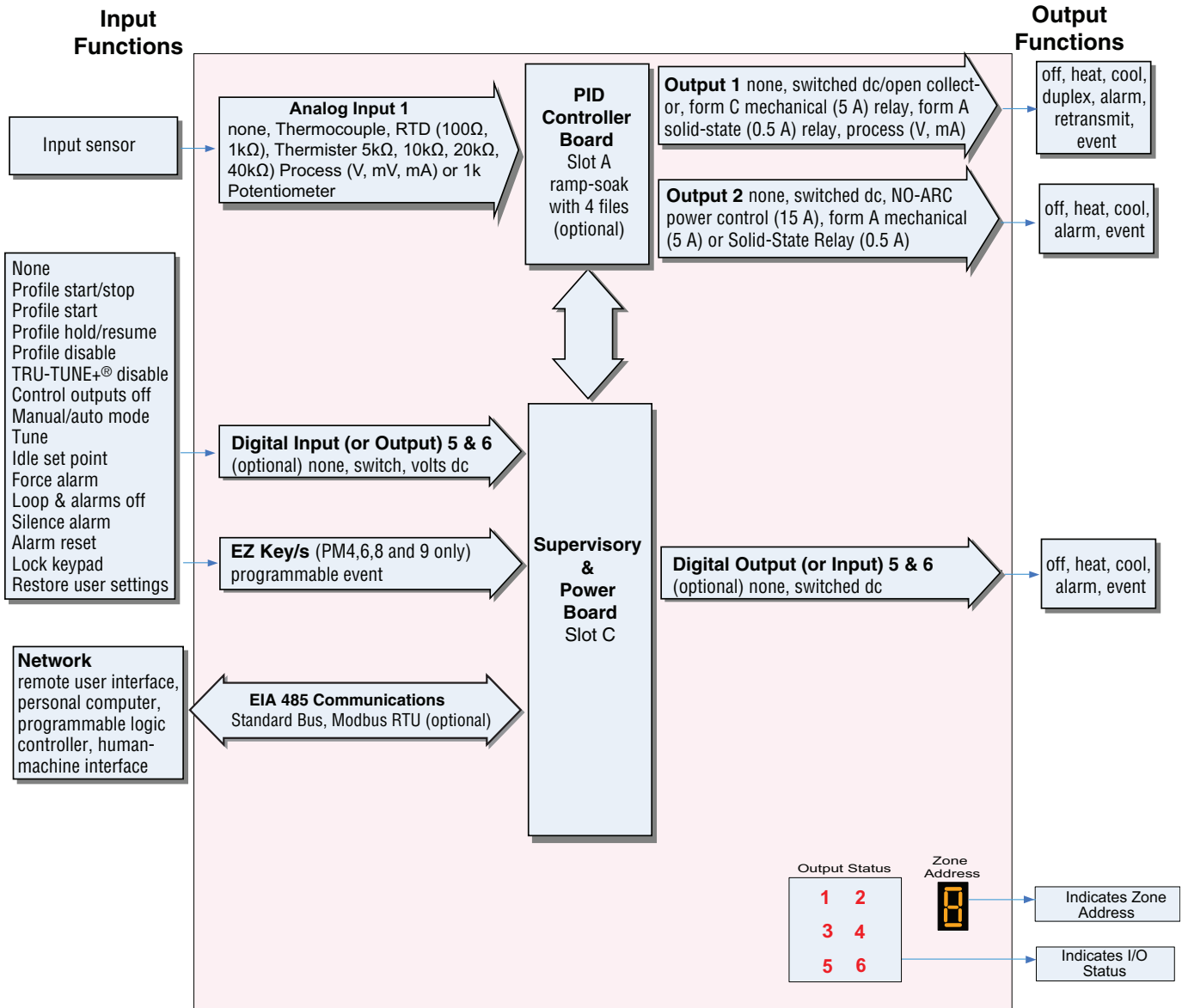

# 2

## Chapter 2: Install and Wire

### Dimensions

1/32 DIN

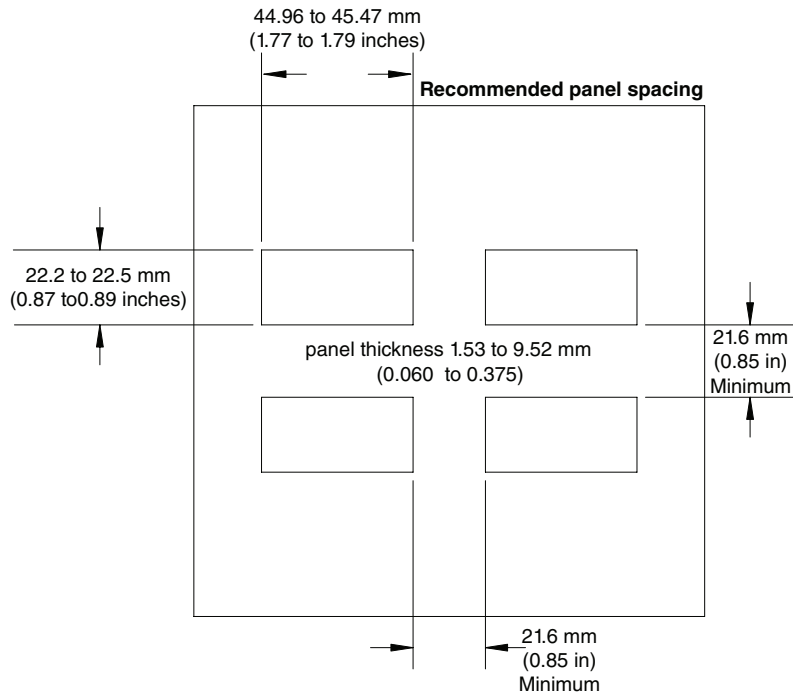
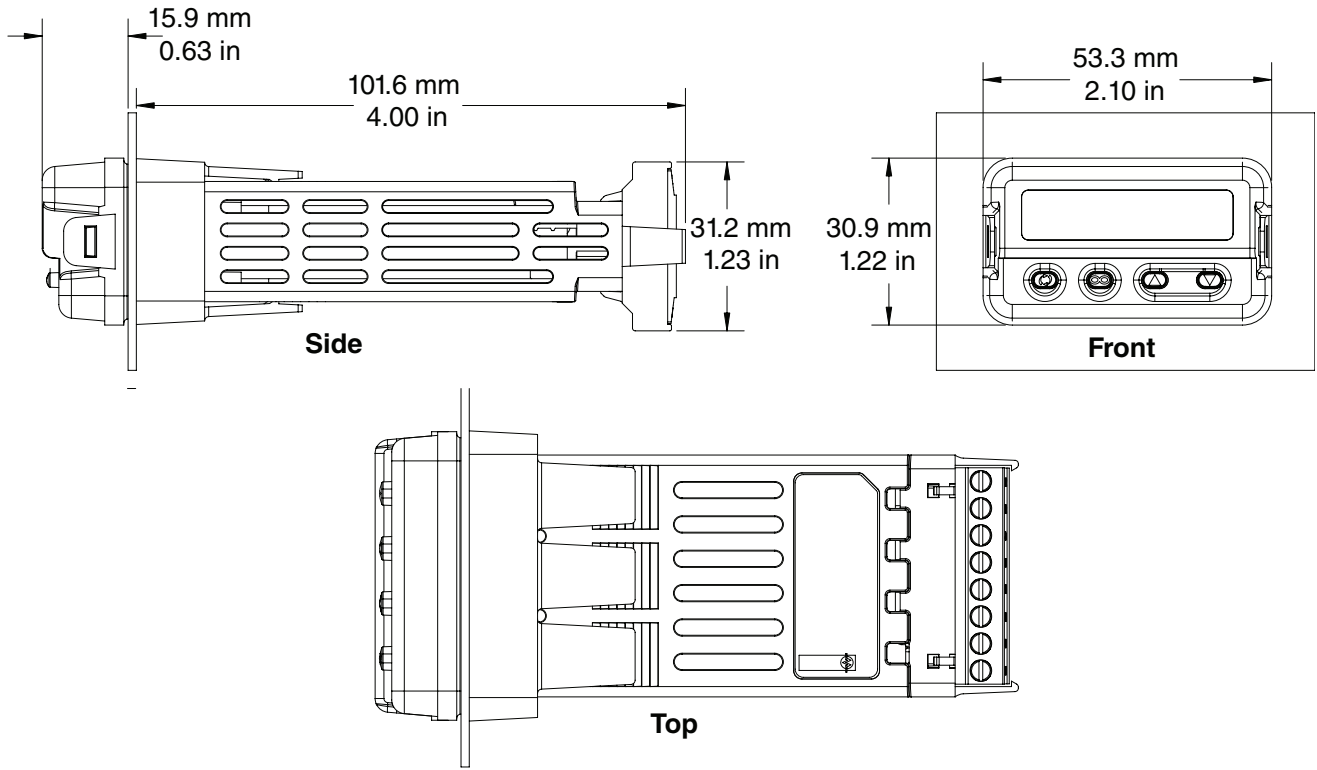

**1/16 DIN**

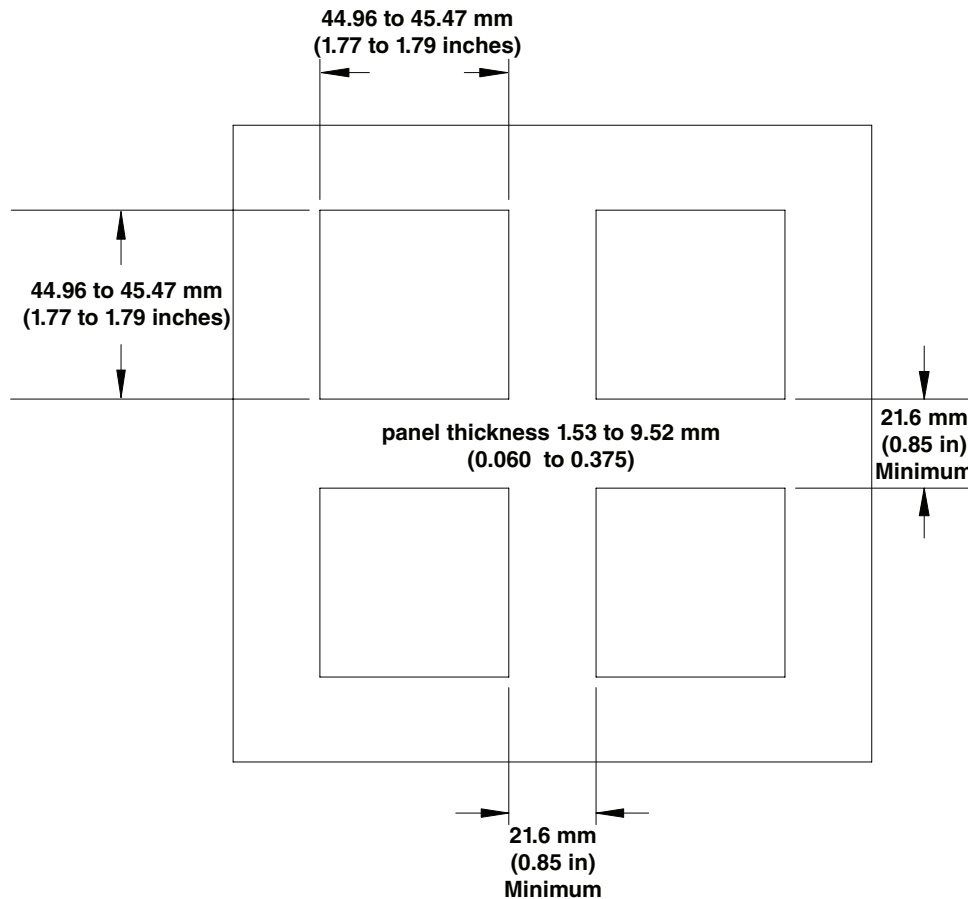
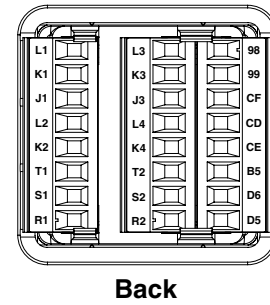
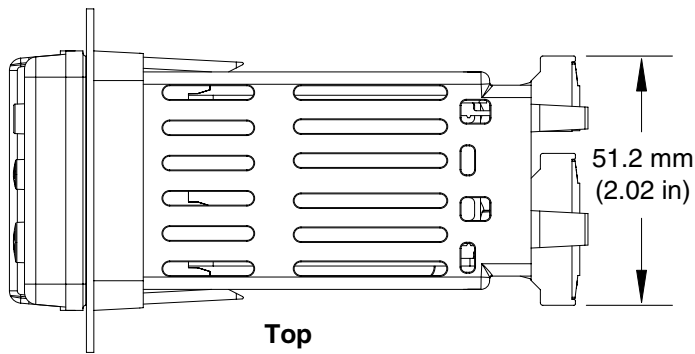
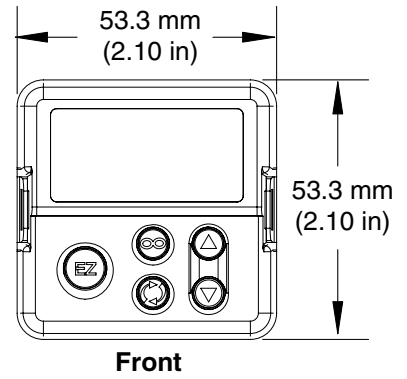
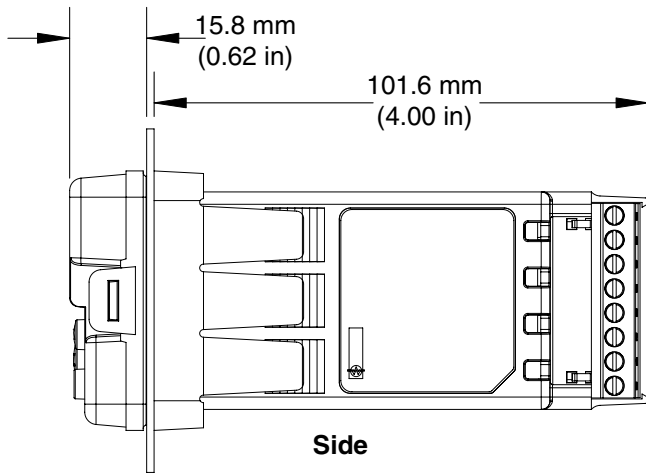



# 1/8 DIN (PM8) Vertical

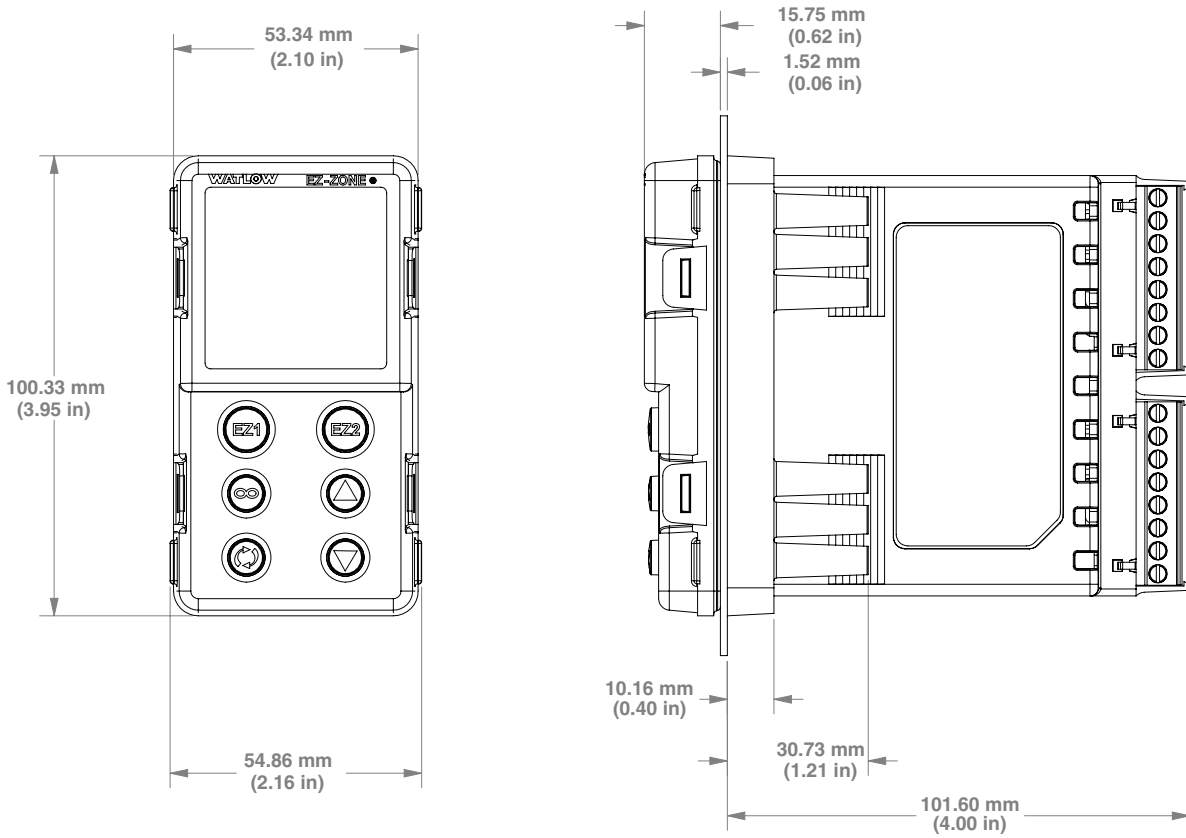

## 1/8 DIN (PM8) Vertical Recommended Panel Spacing

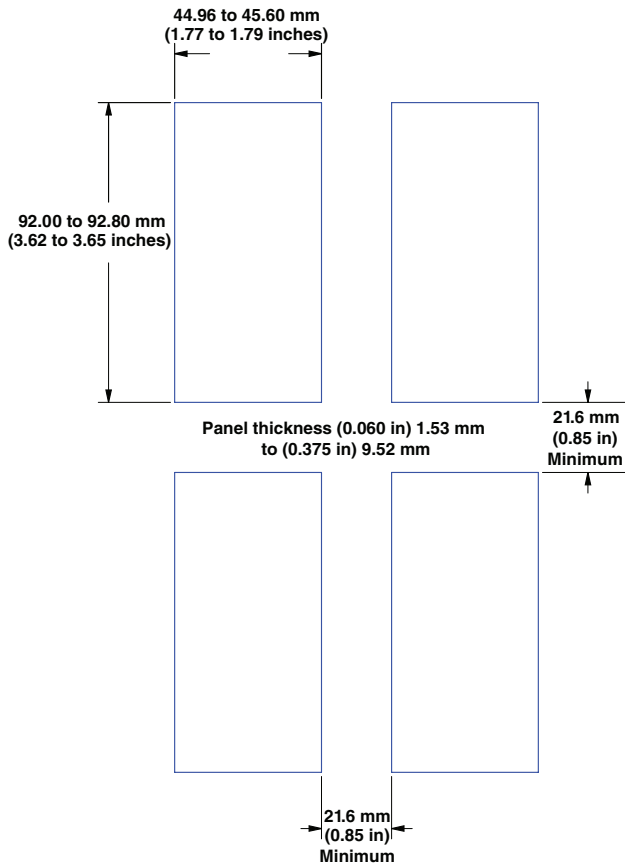

# 1/8 DIN (PM9) Horizontal

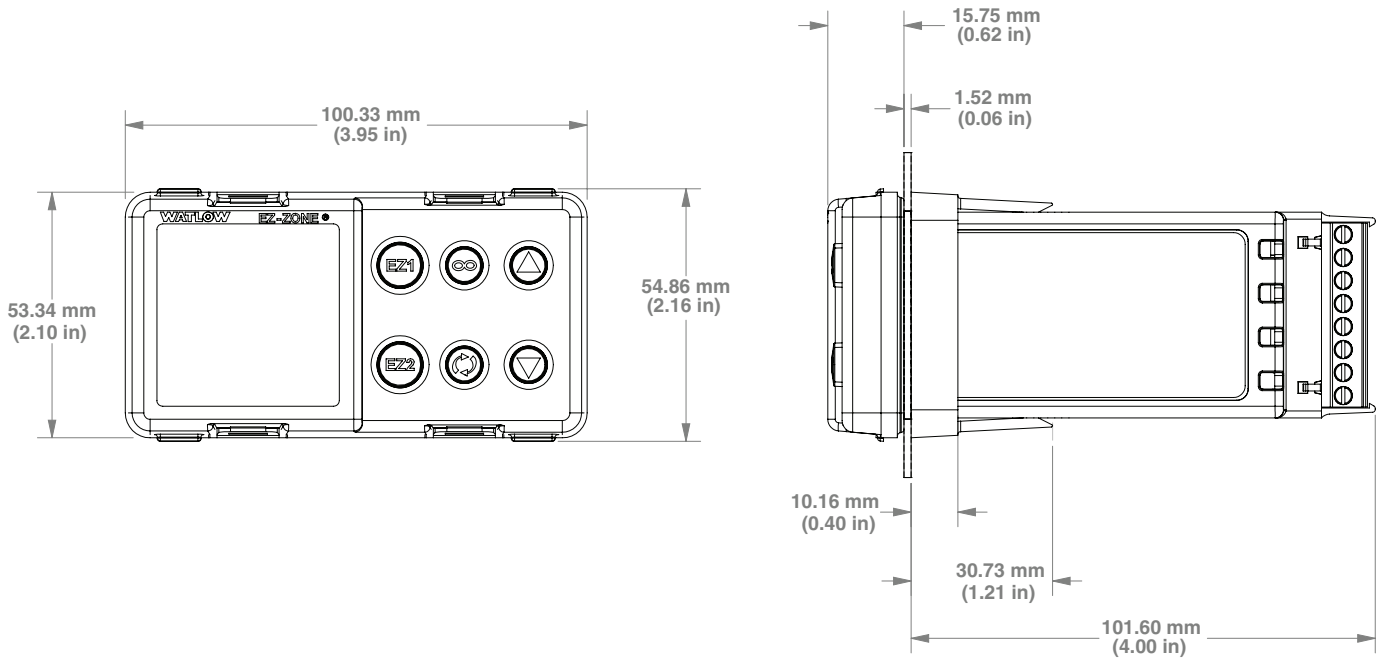

## 1/8 DIN (PM9) Horizontal Recommended Panel Spacing

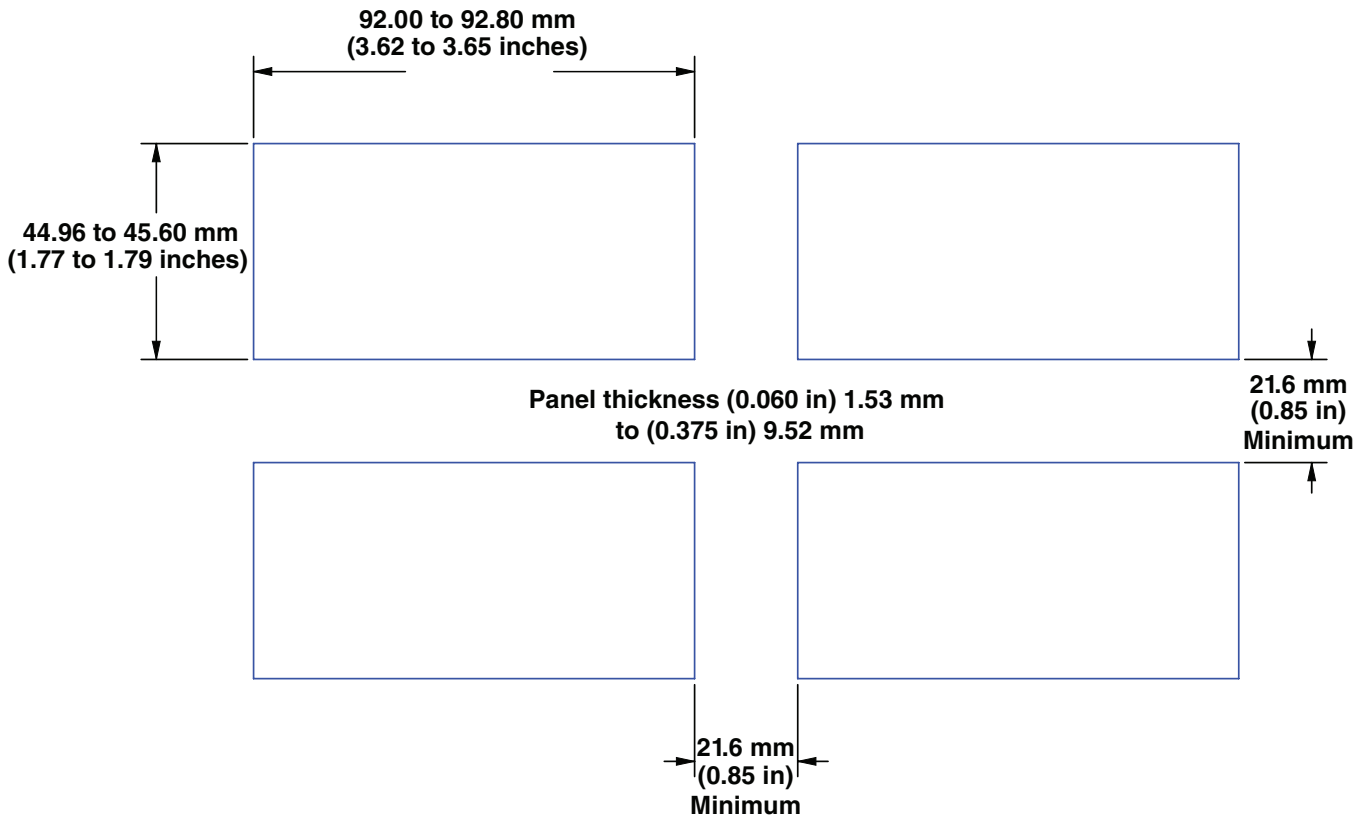

# 1/4 DIN (PM4)

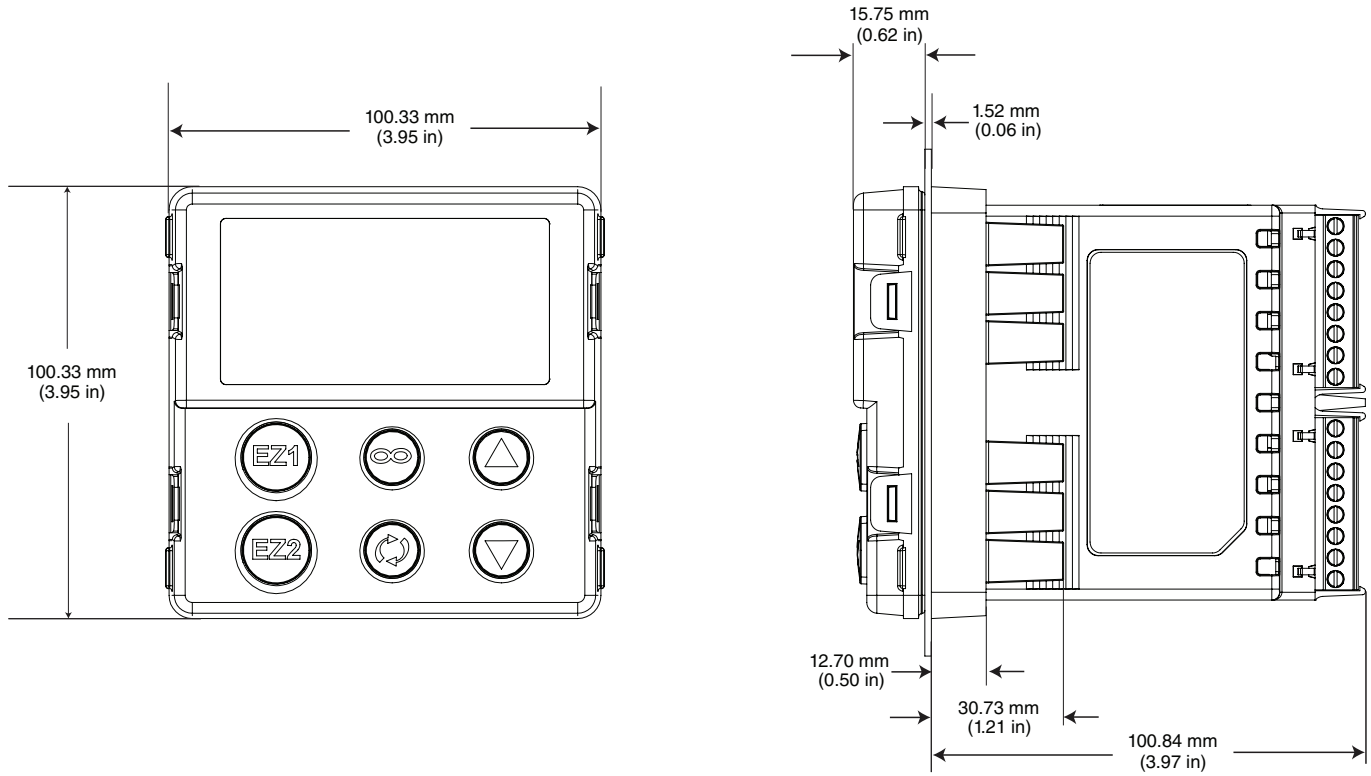

## 1/4 DIN (PM4) Recommended Panel Spacing

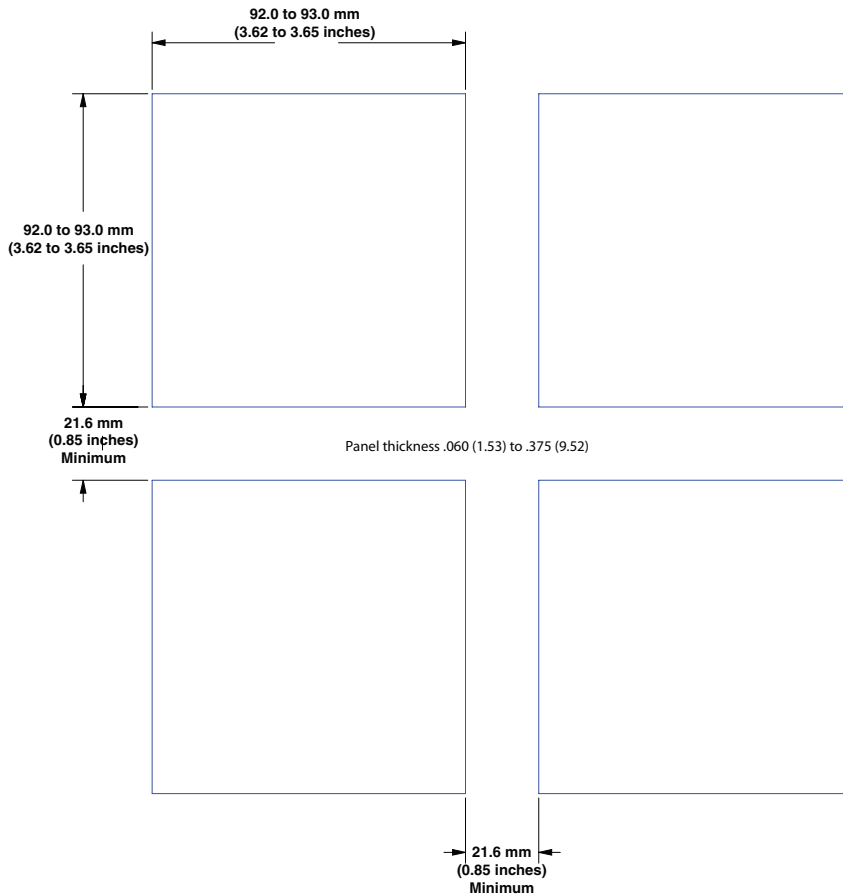

## Installation

1. Make the panel cutout using the mounting template dimensions in this chapter. Insert the case assembly into the panel cutout.
2. While pressing the case assembly firmly against the panel, slide the mounting collar over the back of the controller.

### Note:

If the installation does not require a NEMA 4X seal, simply slide together until the gasket is compressed.

3. For a NEMA 4X (UL50, IP65) seal, alternately place and push the blade of a screwdriver against each of the four corners of the mounting collar assembly. Apply pressure to the face of the controller while pushing with the screwdriver. Don't be afraid to apply enough pressure to properly install the controller. The seal system is compressed more by mating the mounting collar tighter to the front panel (see pictures above). If you can move the case assembly back and forth in the cutout, you do not have a proper seal.

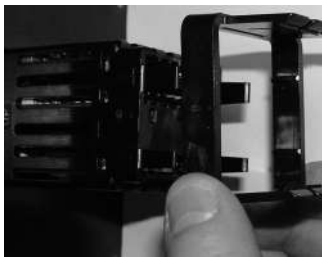
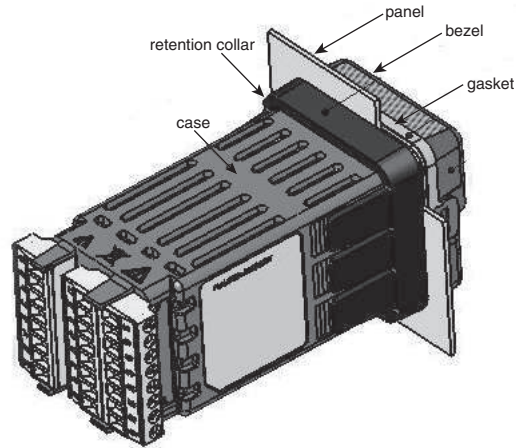

Slide the mounting collar over the back of the controller.

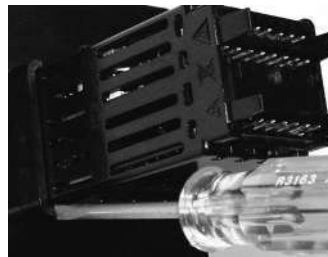

Place the blade of a screwdriver in the notch of the mounting collar assembly.

The tabs on each side of the mounting collar have teeth that latch into the ridges on the sides of the controller. Each tooth is staggered at a different depth from the front so that only one of the tabs, on each side, is locked onto the ridges at a time.

### Note:

There is a graduated measurement difference between the upper and lower half of the display to the panel. In order to meet the seal requirements mentioned above, ensure that the distance from the front of the top half of the display to the panel is 16 mm (0.630 in.) or less, and the distance from the front of the bottom half and the panel is 13.3 mm (0.525 in.) or less.

## Removing the Mounted Controller from Its Case

1. From the controller's face, pull out the tabs on each side until you hear it click.



Pull out the tab on each side until you hear it click.



Grab the unit above and below the face and pull forward.

2. On a PM6 control once the sides are released grab the unit above and below the face with two hands and pull the unit out. On the PM4/8/9 controls slide a screwdriver under the pry tabs and turn.

### WARNING!

- This equipment is suitable for use in class 1, div. 2, Groups A, B, C and D or Non-Hazardous locations only. Temperature Code T4A.
- WARNING - EXPLOSION HAZARD. Substitution of component may impair suitability for class 1, div. 2.
- WARNING - EXPLOSION HAZARD. Do not disconnect equipment unless power has been switched off or the area is known to be nonhazardous.

---

## Returning the Controller to its Case

1. Ensure that the orientation of the controller is correct and slide it back into the housing.

### Note:

The controller is keyed so if it feels that it will not slide back in do not force it. Check the orientation again and reinsert after correcting.

2. Using your thumbs push on either side of the controller until both latches click.

---

## Chemical Compatibility

This product is compatible with acids, weak alkalis, alcohols, gamma radiation and ultra-violet radiation. This product is not compatible with strong alkalis, organic solvents, fuels, aromatic hydrocarbons, chlorinated hydrocarbons, esters and keytones.

### WARNING!

All electrical power to the controller and controlled circuits must be disconnected before removing the controller from the front panel or disconnecting other wiring. Failure to follow these instructions may cause an electrical shock and/or sparks that could cause an explosion in class 1, div. 2 hazardous locations.

## Wiring

### Terminal Definitions for Slots A

Slot A	Terminal Function	Configuration
<b>Inputs</b>		
<b>Universal, RTD and Thermistor Inputs</b>		
T1 S1 R1	S2 (RTD) or current + S3 (RTD), thermocouple -, current -, potentiometer wiper, thermistor or volts - S1 (RTD), thermocouple +, volts +, potentiometer or thermistor	Input 1: all configurations
<b>Output</b>		
<b>Switched dc/open collector</b>		
1	2	
X1 W1 Y1	common (Any switched dc output can use this common.) dc- (open collector) dc+	Output 1: PM ___ [C] _- AAAA _ _
<b>Switched dc</b>		
	W2 dc- Y2 dc+	Output 2: PM _ _ _ _ [C]-_ AAAA _ _
<b>Universal Process</b>		
F1 G1 H1	voltage or current - voltage + current +	Output 1: PM ___ [F] _- AAAA _ _
<b>Mechanical Relay 5 A, Form C</b>		
L1 K1 J1	normally open common normally closed	Output 1: PM ___ [E] _- AAAA _ _
<b>NO-ARC 15 A, Form A</b>		
	L2 normally open K2 common	Output 2: PM[4, 6, 8, 9] ___ [H]-_ AAAA _ _
<b>Mechanical Relay 5 A, Form A</b>		
	L2 normally open K2 common	Output 2: PM _ _ _ _ [J]-_ AAAA _ _
<b>Solid-State Relay 0.5 A, Form A</b>		
L1 K1	L2 normally open K2 common	Output 1: PM ___ [K] _- AAAA _ _ Output 2: PM _ _ _ _ [K]-_ AAAA _ _

## Terminal Definitions for Slot C

Slot C	Terminal Function	Configuration
<b>Power</b>		
98	Power input: ac or dc+	all
99	Power input: ac or dc-	
<b>Standard Bus</b>		
CF	Standard Bus EIA-485 common	PM _____-[A] AAAA __
CD	Standard Bus EIA-485 T-/R-	
CE	Standard Bus EIA-485 T+/R+	
<b>Standard Bus or Modbus EIA-485</b>		
CC	Standard Bus or Modbus RTU EIA-485 common	PM _____-[1] AAAA __
CA	Standard Bus or Modbus RTU EIA-485 T-/R-	
CB	Standard Bus or Modbus RTU EIA-485 T+/R+	
<b>Digital Input/Output</b>		
B5	Digital input-output common	PM __ [2] _ _ _ AAAA __
D6	Digital input or output 6	
D5	Digital input or output 5	PM __ [4] _ _ _ AAAA __

### Slot Orientation - Back View

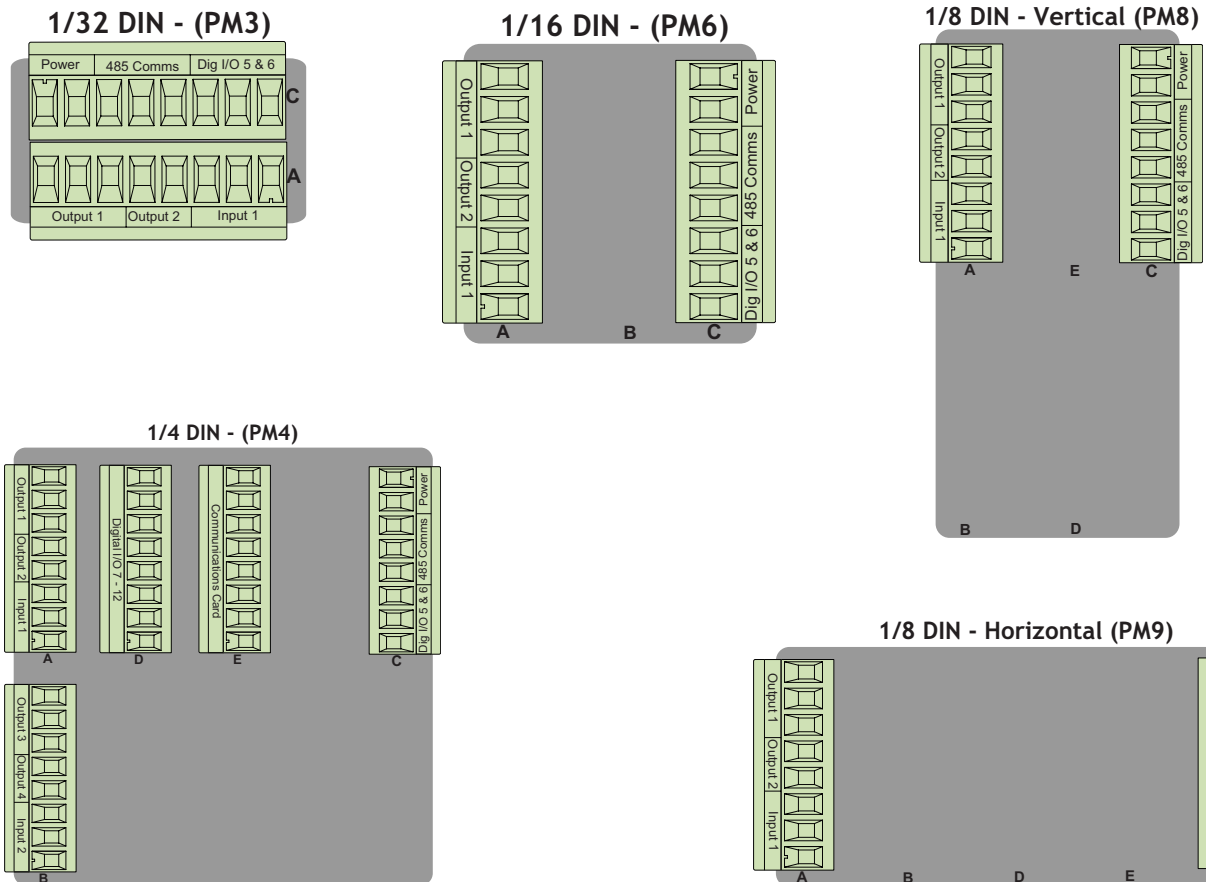

# EZ-ZONE PM Isolation Blocks

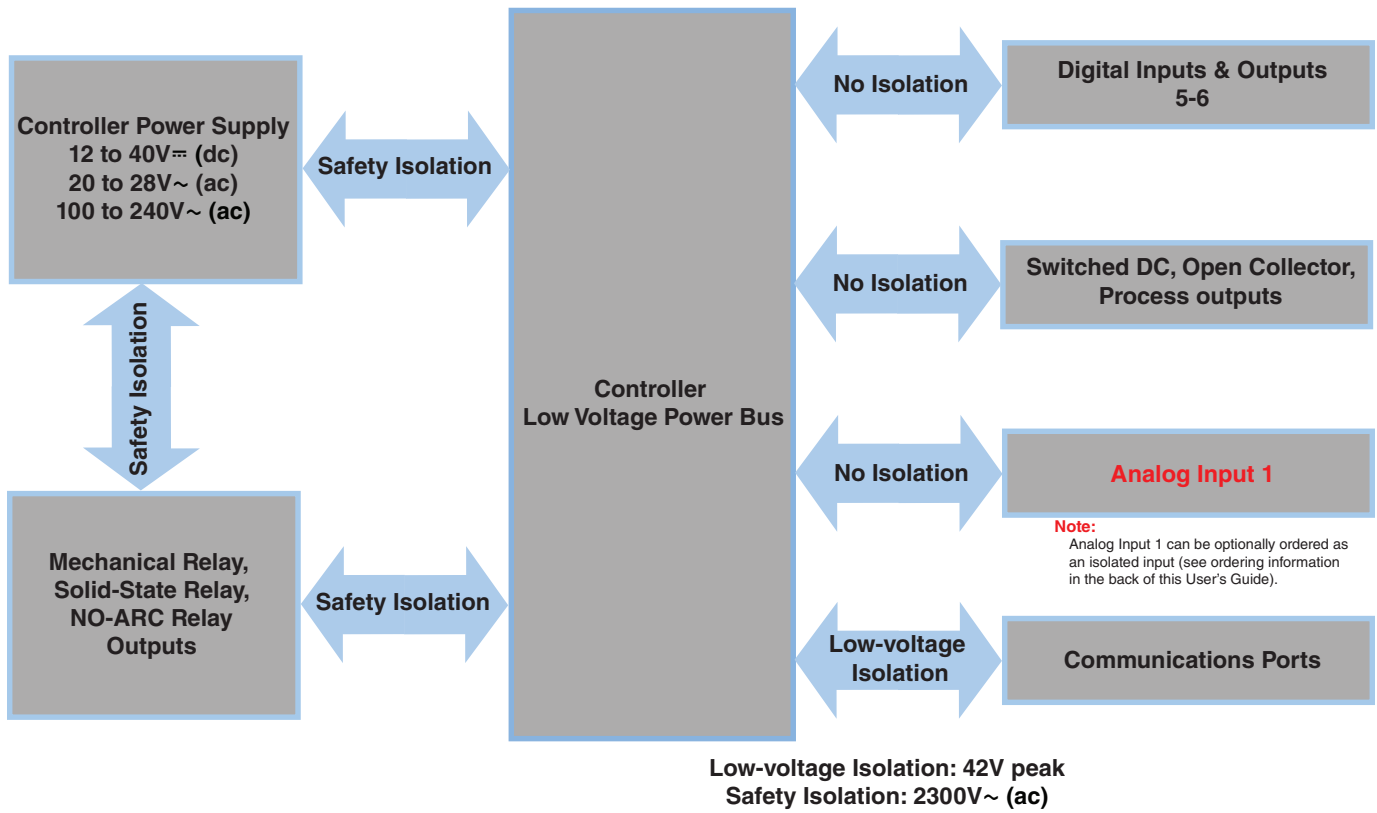



**Warning:** ⚠

Use National Electric (NEC) or other country-specific standard wiring and safety practices when wiring and connecting this controller to a power source and to electrical sensors or peripheral devices. Failure to do so may result in damage to equipment and property, and/or injury or loss of life.

**Note:**

- Maximum wire size termination and torque rating:
- 0.0507 to 3.30 mm<sup>2</sup> (30 to 12 AWG) single-wire termination or two 1.31 mm<sup>2</sup> (16 AWG)
  - 0.56 Nm (5.0 in-lb.) torque

**Note:**

Adjacent terminals may be labeled differently, depending on the model number.

**Note:**

To prevent damage to the controller, do not connect wires to unused terminals.

**Note:**

Maintain electrical isolation between analog input 1, digital input-outputs, switched dc/open collector outputs and process outputs to prevent ground loops.

**Note:**

This equipment is suitable for use in CLASS I, DIVISION 2, Groups A, B, C and D or Non-Hazardous locations only. Temperature Code T4A

**Warning:** ⚠

Explosion Hazard - Dry contact closure Digital Inputs shall not be used in Class I Division 2 Hazardous Locations unless switch used is approved for this application.

**Warning:** ⚠

Explosion Hazard – Substitution of component may impair suitability for CLASS I, DIVISION 2.

**Warning:** ⚠

Explosion Hazard - Do not disconnect while the circuit is live or unless the area is known to be free of ignitable concentrations of flammable substances.

### Low Power

PM\_\_ [3,4] \_ \_ - \_ \_ \_ \_ \_

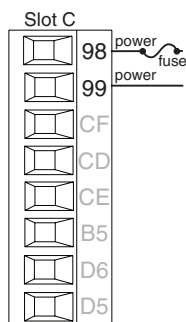

- Minimum/Maximum Ratings
- 12 to 40V $\overline{=}$  (dc)
- 20 to 28V $\sim$  (ac) Semi Sig F47
- 47 to 63 Hz
- 14VA maximum power consumption (PM4, 8 and 9)
- 10VA maximum power consumption (PM6)

### High Power

PM\_\_ [1,2] \_ \_ - \_ \_ \_ \_ \_

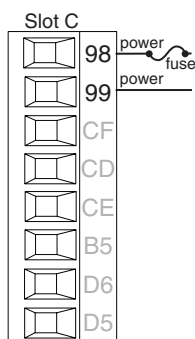

- Minimum/Maximum Ratings
- 85 to 264V $\sim$  (ac)
- 100 to 240V $\sim$  (ac) Semi Sig F47
- 47 to 63 Hz
- 14VA maximum power consumption (PM4,8 and 9)
- 10VA maximum power consumption (PM3 and 6)

### Digital Input 5, 6

PM\_\_ [2,4] \_ \_ - \_ \_ \_ \_ \_

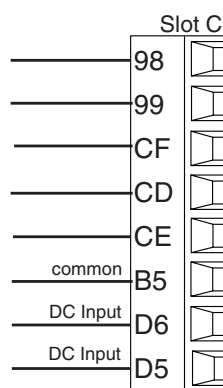

#### Digital Input

- Update rate 10 Hz
- Dry contact or dc voltage

#### DC Voltage

- Input not to exceed 36V $\overline{=}$  (dc) at 3mA
- Input active when > 3V $\overline{=}$  (dc) @ 0.25 mA

- Input inactive when < 2V

#### Dry Contact

- Input inactive when > 500 $\Omega$
- Input active when < 100 $\Omega$
- Maximum short circuit 13mA

#### Voltage Input

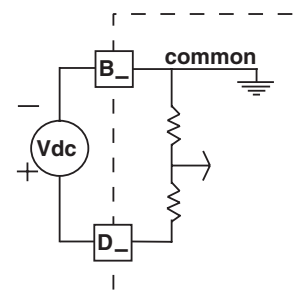

#### Dry Contact

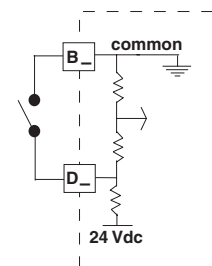

**Warning:** ⚠

Use National Electric (NEC) or other country-specific standard wiring and safety practices when wiring and connecting this controller to a power source and to electrical sensors or peripheral devices. Failure to do so may result in damage to equipment and property, and/or injury or loss of life.

**Note:**

Maximum wire size termination and torque rating:

- 0.0507 to 3.30 mm<sup>2</sup> (30 to 12 AWG) single-wire termination or two 1.31 mm<sup>2</sup> (16 AWG)
- 0.56 Nm (5.0 in-lb.) torque

**Note:**

Adjacent terminals may be labeled differently, depending on the model number.

**Note:**

To prevent damage to the controller, do not connect wires to unused terminals.

**Note:**

Maintain electrical isolation between analog input 1, digital input-outputs, switched dc/open collector outputs and process outputs to prevent ground loops.

**Note:**

This equipment is suitable for use in CLASS I, DIVISION 2, Groups A, B, C and D or Non-Hazardous locations only. Temperature Code T4A

**Warning:** ⚠

Explosion Hazard - Dry contact closure Digital Inputs shall not be used in Class I Division 2 Hazardous Locations unless switch used is approved for this application.

**Warning:** ⚠

Explosion Hazard – Substitution of component may impair suitability for CLASS I, DIVISION 2.

**Warning:** ⚠

Explosion Hazard - Do not disconnect while the circuit is live or unless the area is known to be free of ignitable concentrations of flammable substances.

### Input 1 Thermocouple

PM \_ \_ \_ \_ \_ - \_ A A A A \_ \_

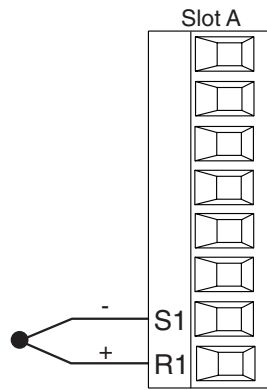

- 2kΩ maximum source resistance
- >20MΩ input impedance
- 3μA open-sensor detection
- Thermocouples are polarity sensitive. The negative lead (usually red) must be connected to S1.
- To reduce errors, the extension wire for thermocouples must be of the same alloy as the thermocouple.

### Input 1 RTD

PM \_ \_ \_ \_ \_ - \_ A A A A \_ \_

#### 2 Wire

#### 3 Wire

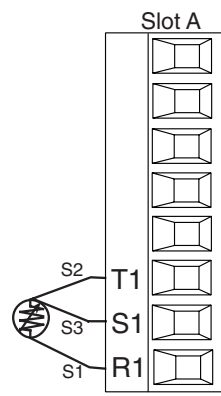
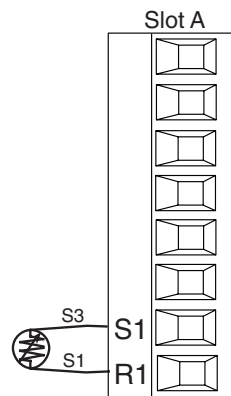

- Platinum, 100 and 1kΩ @ 0°C
- Calibration to DIN curve (0.00385 Ω/Ω/°C)
- 20Ω total lead resistance
- RTD excitation current of 0.09mA typical. Each ohm of lead resistance may affect the reading by 0.03°C.
- For 3-wire RTDs, the S1 lead (usually white) must be connected to R1.
- For best accuracy use a 3-wire RTD to compensate for lead-length resistance. All three lead wires must have the same resistance.

### Input 1 Process

PM \_ \_ \_ \_ \_ - \_ A A A A \_ \_

#### Volts

#### Amperes

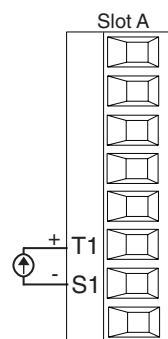
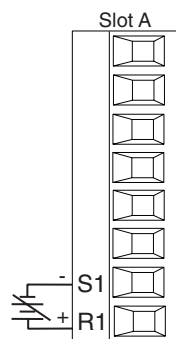

- 0 to 20mA @ 100Ω input impedance
- 0 to 10V<sub>DC</sub> @ 20kΩ input impedance
- 0 to 50mV<sub>DC</sub> @ 20kΩ input impedance
- Scalable

**Warning:** ⚠

Use National Electric (NEC) or other country-specific standard wiring and safety practices when wiring and connecting this controller to a power source and to electrical sensors or peripheral devices. Failure to do so may result in damage to equipment and property, and/or injury or loss of life.

**Note:**

Maximum wire size termination and torque rating:

- 0.0507 to 3.30 mm<sup>2</sup> (30 to 12 AWG) single-wire termination or two 1.31 mm<sup>2</sup> (16 AWG)
- 0.56 Nm (5.0 in-lb.) torque

**Note:**

Adjacent terminals may be labeled differently, depending on the model number.

**Note:**

To prevent damage to the controller, do not connect wires to unused terminals.

**Note:**

Maintain electrical isolation between digital input-outputs, switched dc/open collector outputs and process outputs to prevent ground loops.

**Note:**

This equipment is suitable for use in CLASS I, DIVISION 2, Groups A, B, C and D or Non-Hazardous locations only. Temperature Code T4

**Warning:** ⚠

Explosion Hazard – Substitution of component may impair suitability for CLASS I, DIVISION 2.

**Warning:** ⚠

Explosion Hazard - Do not disconnect while the circuit is live or unless the area is known to be free of ignitable concentrations of flammable substances.

**Quencharc Note:**

Switching pilot duty inductive loads (relay coils, solenoids, etc.) with the mechanical relay, solid state relay or open collector output options requires use of an R.C. suppressor.

### Input 1 Potentiometer

PM \_ \_ \_ \_ \_ - \_ A A A A \_ \_

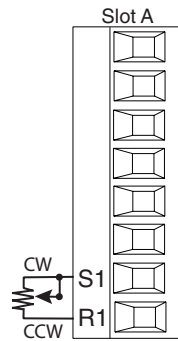

- Use a 1kΩ potentiometer.

### Input 1 Thermistor

PM \_ [J,N,E\*] \_ \_ \_ - \_ A A A A \_ \_

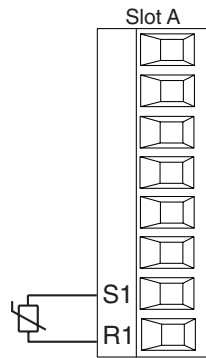

- >20MΩ input impedance
- 3μA open-sensor detection
- \*PM4,8 & 9 only

### Digital Output 5, 6

PM \_ \_ [2,4] \_ \_ - \_ A A A A \_ \_

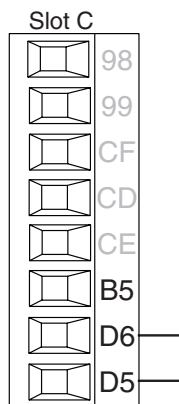

#### Digital Output

- SSR drive signal
- Update rate 10 Hz
- Maximum open circuit voltage is 22 to 25V<sub>rms</sub> (dc)
- PNP transistor source
- Typical drive; 21mA @ 4.5V for DO5, and 11mA @ 4.5V for DO6
- Current limit 24mA for Output 5 and 12mA Output 6
- Output 5 capable of driving one 3-pole DIN-A-MITE
- Output 6 capable of driving one 1-pole DIN-A-MITE

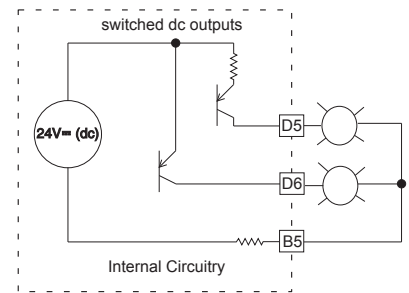

**Note:**

See output curves below.

**Warning:** 

Use National Electric (NEC) or other country-specific standard wiring and safety practices when wiring and connecting this controller to a power source and to electrical sensors or peripheral devices. Failure to do so may result in damage to equipment and property, and/or injury or loss of life.

**Note:**

Maximum wire size termination and torque rating:

- 0.0507 to 3.30 mm<sup>2</sup> (30 to 12 AWG) single-wire termination or two 1.31 mm<sup>2</sup> (16 AWG)
- 0.56 Nm (5.0 in-lb.) torque

**Note:**

Adjacent terminals may be labeled differently, depending on the model number.

**Note:**

To prevent damage to the controller, do not connect wires to unused terminals.

**Note:**

Maintain electrical isolation between digital input-outputs, switched dc/open collector outputs and process outputs to prevent ground loops.

**Note:**

This equipment is suitable for use in CLASS I, DIVISION 2, Groups A, B, C and D or Non-Hazardous locations only. Temperature Code T4

**Warning:** 

Explosion Hazard – Substitution of component may impair suitability for CLASS I, DIVISION 2.

**Warning:** 

Explosion Hazard - Do not disconnect while the circuit is live or unless the area is known to be free of ignitable concentrations of flammable substances.

**Quencharc Note:**

Switching pilot duty inductive loads (relay coils, solenoids, etc.) with the mechanical relay, solid state relay or open collector output options requires use of an R.C. suppressor.

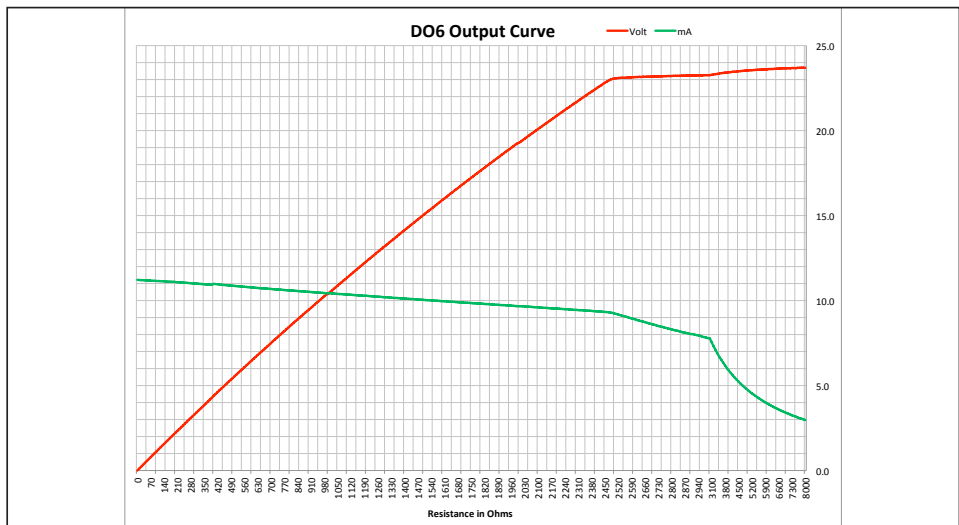
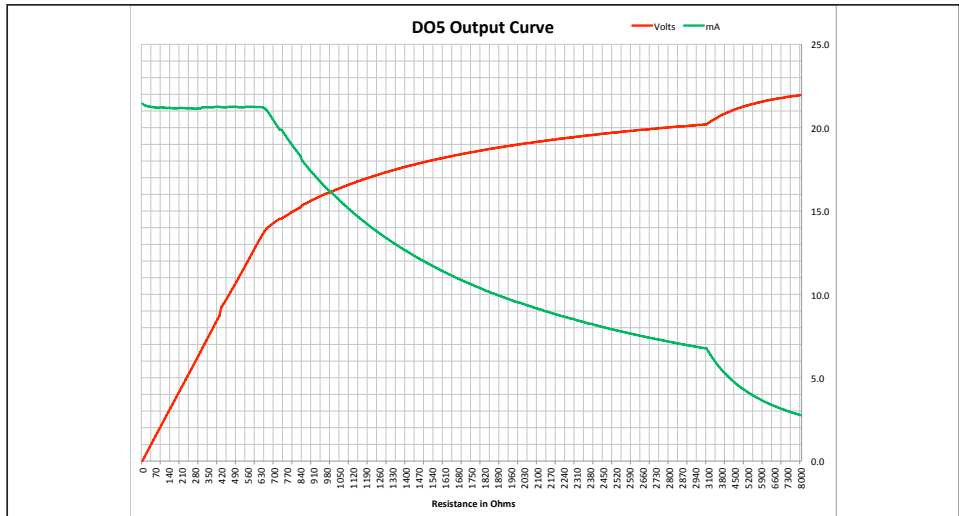

**Switched DC Wiring Example Using DO 5 and 6**

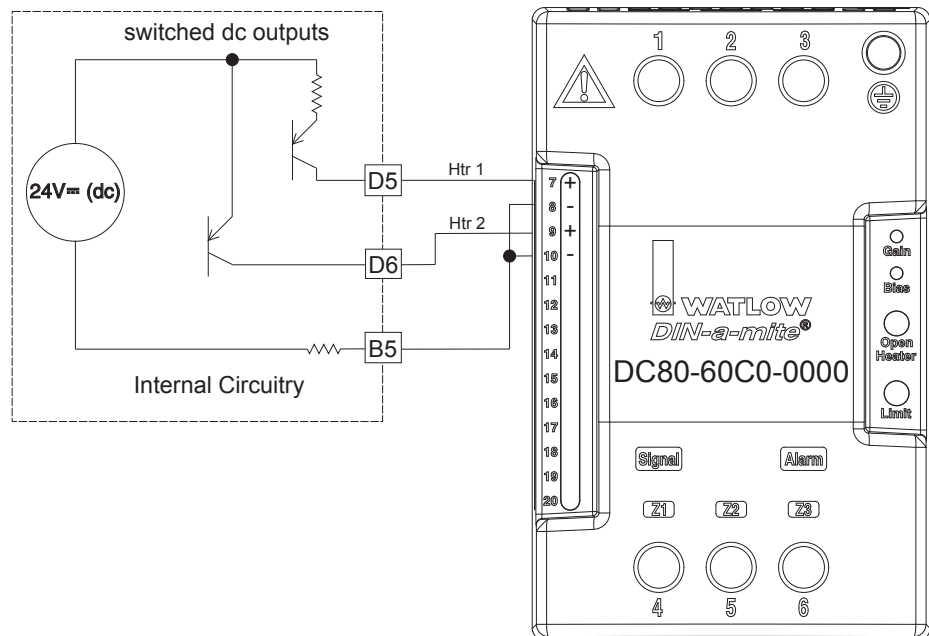

**Warning:** ⚠

Use National Electric (NEC) or other country-specific standard wiring and safety practices when wiring and connecting this controller to a power source and to electrical sensors or peripheral devices. Failure to do so may result in damage to equipment and property, and/or injury or loss of life.

**Note:**

Maximum wire size termination and torque rating:

- 0.0507 to 3.30 mm<sup>2</sup> (30 to 12 AWG) single-wire termination or two 1.31 mm<sup>2</sup> (16 AWG)
- 0.56 Nm (5.0 in-lb.) torque

**Note:**

Adjacent terminals may be labeled differently, depending on the model number.

**Note:**

To prevent damage to the controller, do not connect wires to unused terminals.

**Note:**

Maintain electrical isolation between digital input-outputs, switched dc/open collector outputs and process outputs to prevent ground loops.

**Note:**

This equipment is suitable for use in CLASS I, DIVISION 2, Groups A, B, C and D or Non-Hazardous locations only. Temperature Code T4

**Warning:** ⚠

Explosion Hazard – Substitution of component may impair suitability for CLASS I, DIVISION 2.

**Warning:** ⚠

Explosion Hazard - Do not disconnect while the circuit is live or unless the area is known to be free of ignitable concentrations of flammable substances.

**Quencharc Note:**

Switching pilot duty inductive loads (relay coils, solenoids, etc.) with the mechanical relay, solid state relay or open collector output options requires use of an R.C. suppressor.

## Output 1 Switched DC/Open Collector

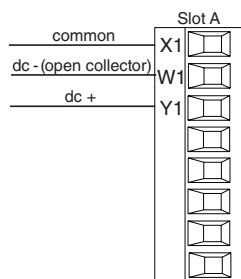

### Switched DC

- Maximum open circuit voltage is 22 to 25V<sub>rms</sub> (dc)
- 30mA max. per single output / 40mA max. total per paired outputs (1 & 2)
- Typical drive; 4.5V<sub>rms</sub> (dc) @ 30mA
- Short circuit limited to <50mA
- NPN transistor sink
- Use dc- and dc+ to drive external solid-state relay
- 1-pole DIN-A-MITE: up to 4 in parallel or 4 in series
- 2-pole DIN-A-MITE: up to 2 in parallel or 2 in series
- 3-pole DIN-A-MITE: up to 2 in series

### Open Collector

- 100mA maximum output current sink
- 30V<sub>rms</sub> (dc) max. supply voltage
- Any switched dc output can use the common terminal.
- Use an external power supply to control a dc load, with the load positive to the positive of the power supply, the load negative to the open collector and common to the power supply negative.

See Quencharc note.

### Switched DC

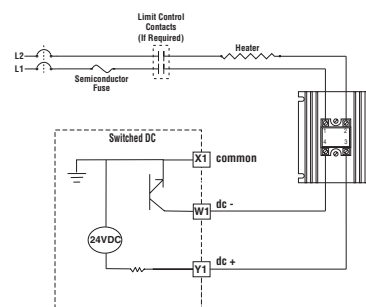

### Open Collector

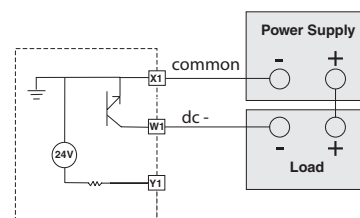

**Warning:** ⚠

Use National Electric (NEC) or other country-specific standard wiring and safety practices when wiring and connecting this controller to a power source and to electrical sensors or peripheral devices. Failure to do so may result in damage to equipment and property, and/or injury or loss of life.

**Note:**

Maximum wire size termination and torque rating:

- 0.0507 to 3.30 mm<sup>2</sup> (30 to 12 AWG) single-wire termination or two 1.31 mm<sup>2</sup> (16 AWG)
- 0.56 Nm (5.0 in-lb.) torque

**Note:**

Adjacent terminals may be labeled differently, depending on the model number.

**Note:**

To prevent damage to the controller, do not connect wires to unused terminals.

**Note:**

Maintain electrical isolation between digital input-outputs, switched dc/open collector outputs and process outputs to prevent ground loops.

**Note:**

This equipment is suitable for use in CLASS I, DIVISION 2, Groups A, B, C and D or Non-Hazardous locations only. Temperature Code T4

**Warning:** ⚠

Explosion Hazard – Substitution of component may impair suitability for CLASS I, DIVISION 2.

**Warning:** ⚠

Explosion Hazard - Do not disconnect while the circuit is live or unless the area is known to be free of ignitable concentrations of flammable substances.

**Quencharc Note:**

Switching pilot duty inductive loads (relay coils, solenoids, etc.) with the mechanical relay, solid state relay or open collector output options requires use of an R.C. suppressor.

## Output 1 Mechanical Relay, Form C

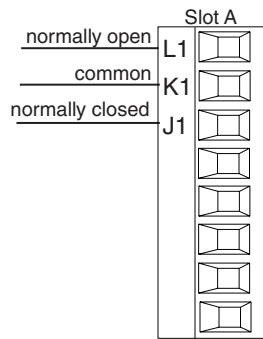

- 5A at 240V~ (ac) or 30V= (dc) maximum resistive load
- 20mA at 24V minimum load
- 125 VA pilot duty at 120/240V~ (ac), 25 VA at 24V~ (ac)
- 100,000 cycles at rated load
- Output does not supply power.
- For use with ac or dc

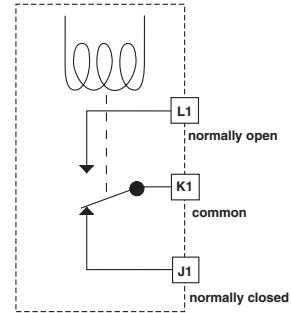

See Quencharc note.

PM \_ \_ \_ [E] \_ \_ A A  
A A \_ \_

## Output 1 Universal Process

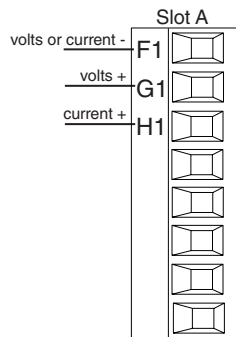

- 0 to 20mA into 800Ω maximum load
- 0 to 10V= (dc) into 1kΩ minimum load
- Scalable
- Output supplies power
- Cannot use voltage and current outputs at same time
- Output may be used as retransmit or control.

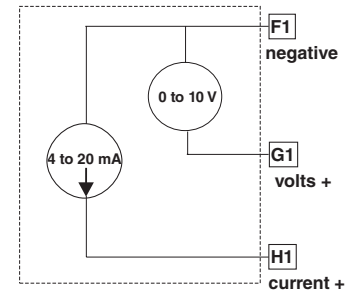

PM \_ \_ \_ [F] \_ \_ A A  
A A \_ \_

**Warning:** ⚠

Use National Electric (NEC) or other country-specific standard wiring and safety practices when wiring and connecting this controller to a power source and to electrical sensors or peripheral devices. Failure to do so may result in damage to equipment and property, and/or injury or loss of life.

**Note:**

Maximum wire size termination and torque rating:

- 0.0507 to 3.30 mm<sup>2</sup> (30 to 12 AWG) single-wire termination or two 1.31 mm<sup>2</sup> (16 AWG)
- 0.56 Nm (5.0 in.-lb.) torque

**Note:**

Adjacent terminals may be labeled differently, depending on the model number.

**Note:**

To prevent damage to the controller, do not connect wires to unused terminals.

**Note:**

Maintain electrical isolation between digital input-outputs, switched dc/open collector outputs and process outputs to prevent ground loops.

**Note:**

This equipment is suitable for use in CLASS I, DIVISION 2, Groups A, B, C and D or Non-Hazardous locations only. Temperature Code T4

**Warning:** ⚠

Explosion Hazard – Substitution of component may impair suitability for CLASS I, DIVISION 2.

**Warning:** ⚠

Explosion Hazard - Do not disconnect while the circuit is live or unless the area is known to be free of ignitable concentrations of flammable substances.

**Quencharc Note:**

Switching pilot duty inductive loads (relay coils, solenoids, etc.) with the mechanical relay, solid state relay or open collector output options requires use of an R.C. suppressor.

### Output 1 Solid-State Relay, Form A

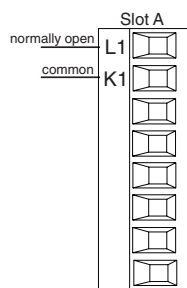

- 0.5A at 20 to 264V~ (ac) maximum resistive load
- 20VA 120/240V~ (ac) pilot duty
- Opto-isolated, without contact suppression
- Maximum off state leakage of 105µA
- Minimum holding current of 10mA
- Output does not supply power
- Do not use on dc loads.
- See Quencharc note.

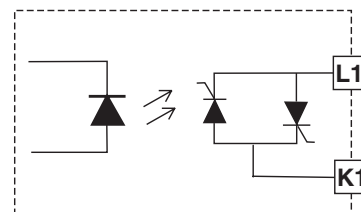

PM \_ \_ \_ [K] \_ \_ A A A A

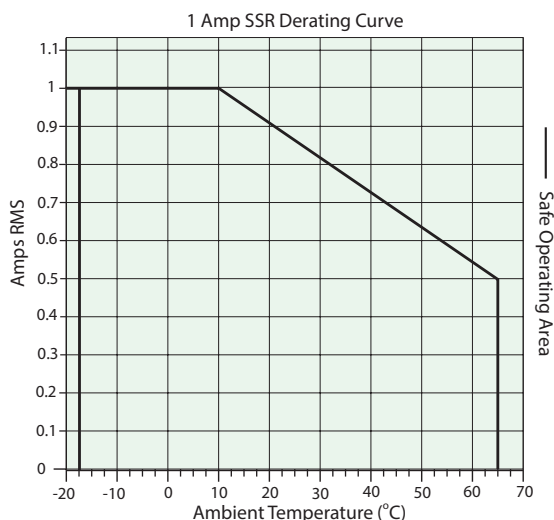

### Output 2 NO-ARC Relay, Form A

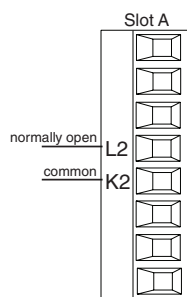

- 15A at 85 to 264V~ (ac) resistive load only
- 2,000,000 cycle rating for NO-ARC circuit
- 100mA minimum load
- 2mA maximum off state leakage
- Do not use on dc loads.
- Output does not supply power.

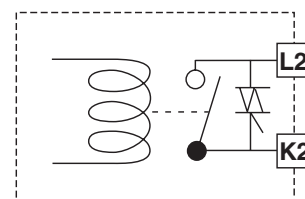

PM [4, 6, 8, 9] \_ \_ \_ [H] \_ \_ A A  
A A \_ \_

**Warning:** ⚠

Use National Electric (NEC) or other country-specific standard wiring and safety practices when wiring and connecting this controller to a power source and to electrical sensors or peripheral devices. Failure to do so may result in damage to equipment and property, and/or injury or loss of life.

**Note:**

Maximum wire size termination and torque rating:

- 0.0507 to 3.30 mm<sup>2</sup> (30 to 12 AWG) single-wire termination or two 1.31 mm<sup>2</sup> (16 AWG)
- 0.56 Nm (5.0 in-lb.) torque

**Note:**

Adjacent terminals may be labeled differently, depending on the model number.

**Note:**

To prevent damage to the controller, do not connect wires to unused terminals.

**Note:**

Maintain electrical isolation between analog input 1, digital input-outputs, switched dc/open collector outputs and process outputs to prevent ground loops.

**Note:**

This equipment is suitable for use in CLASS I, DIVISION 2, Groups A, B, C and D or Non-Hazardous locations only. Temperature Code T4A

**Warning:** ⚠

Explosion Hazard - Dry contact closure Digital Inputs shall not be used in Class I Division 2 Hazardous Locations unless switch used is approved for this application.

**Warning:** ⚠

Explosion Hazard – Substitution of component may impair suitability for CLASS I, DIVISION 2.

**Warning:** ⚠

Explosion Hazard - Do not disconnect while the circuit is live or unless the area is known to be free of ignitable concentrations of flammable substances.

## Output 2 Mechanical Relay, Form A

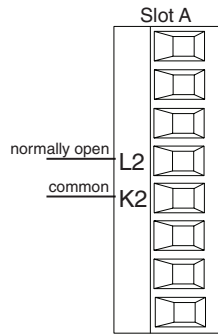

- 5A at 240V~ (ac) or 30V= (dc) maximum resistive load
  - 20mA at 24V minimum load
  - 125VA pilot duty @ 120/240V~ (ac), 25 VA at 24V~ (ac)
  - 100,000 cycles at rated load
  - Output does not supply power.
  - For use with ac or dc
- See Quencharc note.  
PM \_ \_ \_ \_ [J]-\_ AAAA \_ \_

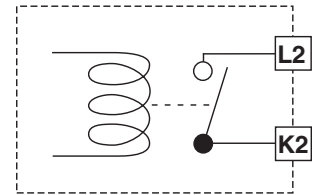

## Output 2 Switched DC

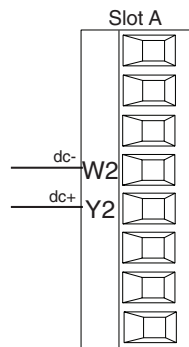

- Maximum open circuit voltage is 22 to 25V= (dc)
- 30mA max. per single output / 40mA max. total per paired outputs (1 & 2)
- Typical drive; 4.5VDC @ 30mA
- Short circuit limited to <50mA
- NPN transistor sink
- Use dc- and dc+ to drive external solid-state relay
- 1-pole DIN-A-MITE: up to 4 in parallel or 4 in series
- 2-pole DIN-A-MITE: up to 2 in parallel or 2 in series
- 3-pole DIN-A-MITE: up to 2 in series

PM \_ \_ \_ \_ [C]-\_ A A AA  
\_ \_

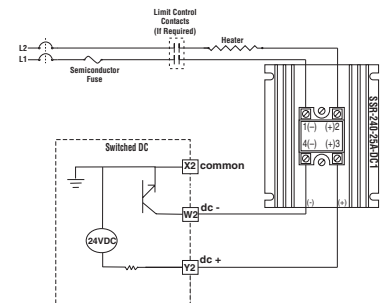



**Warning:** ⚠

Use National Electric (NEC) or other country-specific standard wiring and safety practices when wiring and connecting this controller to a power source and to electrical sensors or peripheral devices. Failure to do so may result in damage to equipment and property, and/or injury or loss of life.

**Note:**

- Maximum wire size termination and torque rating:
  - 0.0507 to 3.30 mm<sup>2</sup> (30 to 12 AWG) single-wire termination or two 1.31 mm<sup>2</sup> (16 AWG)
  - 0.56 Nm (5.0 in-lb.) torque

**Note:**

Adjacent terminals may be labeled differently, depending on the model number.

**Note:**

To prevent damage to the controller, do not connect wires to unused terminals.

**Note:**

Maintain electrical isolation between analog input 1, digital input-outputs, switched dc/open collector outputs and process outputs to prevent ground loops.

**Note:**

This equipment is suitable for use in CLASS I, DIVISION 2, Groups A, B, C and D or Non-Hazardous locations only. Temperature Code T4A

**Warning:** ⚠

Explosion Hazard - Dry contact closure Digital Inputs shall not be used in Class I Division 2 Hazardous Locations unless switch used is approved for this application.

**Warning:** ⚠

Explosion Hazard – Substitution of component may impair suitability for CLASS I, DIVISION 2.

**Warning:** ⚠

Explosion Hazard - Do not disconnect while the circuit is live or unless the area is known to be free of ignitable concentrations of flammable substances.

## Output 2 Solid-State Relay, Form A

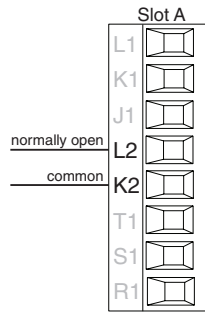

- 0.5A at 20 to 264V~ (ac) maximum resistive load
- 20VA 120/240V~ (ac) pilot duty
- Opto-isolated, without contact suppression
- Maximum off state leakage of 105µA
- Minimum holding current of 10mA
- Output does not supply power.
- Do not use on dc loads.

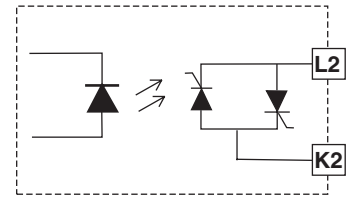

See Quencharc note.

PM \_ \_ \_ \_ [K]-\_ A A A A

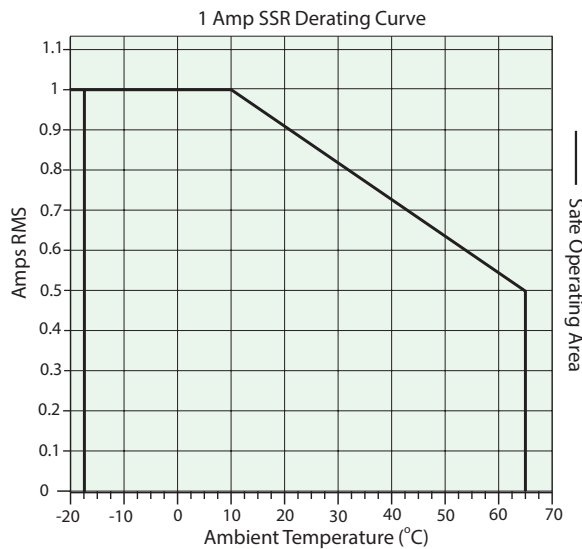

## Quencharc Wiring Example

In this example the Quencharc circuit (Watlow part# 0804-0147-0000) is used to protect PM internal circuitry from the counter electromagnetic force from the inductive user load when de-energized. It is recommended that this or an equivalent Quencharc be used when connecting inductive loads to PM outputs.

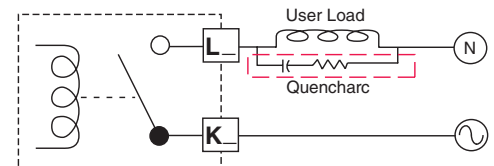

## Standard Bus EIA-485 Communications

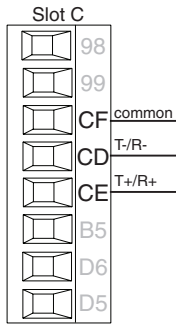

- Wire T-/R- to the A terminal of the EIA-485 port.
- Wire T+/R+ to the B terminal of the EIA-485 port.
- Wire common to the common terminal of the EIA-485 port.
- Do not route network wires with power wires. Connect network wires in daisy-chain fashion when connecting multiple devices in a network.
- Do not connect more than 16 EZ-ZONE PM controllers on a network.
- Maximum network length: 1,200 meters (4,000 feet)
- 1/8th unit load on EIA-485 bus

PM \_ \_ \_ \_ -[A] AAAA \_ \_

### Note:

A 120Ω termination resistor may be required across T+/R+ and T-/R-, placed on the last controller on the network.

### Note:

Do not leave a USB to EIA-485 converter connected to Standard Bus without power (i.e., disconnecting the USB end from the computer while leaving the converter connected on Standard Bus). Disturbance on the Standard Bus may occur.

## Modbus RTU or Standard Bus EIA-485 Communications

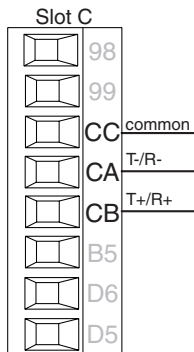

- Wire T-/R- to the A terminal of the EIA-485 port.
- Wire T+/R+ to the B terminal of the EIA-485 port.
- Wire common to the common terminal of the EIA-485 port.
- Do not route network wires with power wires. Connect network wires in daisy-chain fashion when connecting multiple devices in a network.
- A termination resistor may be required. Place a 120 Ω resistor across T+/R+ and T-/R- of last controller on network.
- Only one protocol per port is available at a time: either Modbus RTU or Standard Bus.
- Do not connect more than 16 EZ-ZONE PM controllers on a Standard Bus network.
- Do not connect more than 247 EZ-ZONE PM controllers on a Modbus RTU network.
- Maximum network length: 1,200 meters (4,000 feet)
- 1/8th unit load on EIA-485 bus.

PM \_ \_ \_ \_ -[1] AAAA \_ \_

Modbus-IDA Terminal	EIA/TIA-485 Name	Watlow Terminal Label	Function
D0	A	CA or CD	T-/R-
D1	B	CB or CE	T+/R+
common	common	CC or CF	common

**Note:**

Do not leave a USB to EIA-485 converter connected to Standard Bus without power (i.e., disconnecting the USB end from the computer while leaving the converter connected on Standard Bus). Disturbance on the Standard Bus may occur.

---

**Wiring a Serial EIA-485 Network**

Two example networks are shown below where the first one is using Watlow's Standard Bus and the other showing connections over Modbus. Do not route network wires with power wires. Connect network wires in daisy-chain fashion when connecting multiple devices in a network. A termination resistor may be required. Place a 120 Ω resistor across T+/R+ and T-/R- of the last controller on a network. Only one protocol per port is available at a time: either Modbus RTU or Standard Bus.

---

**A Network Using Watlow's Standard Bus and an RUI/Gateway**

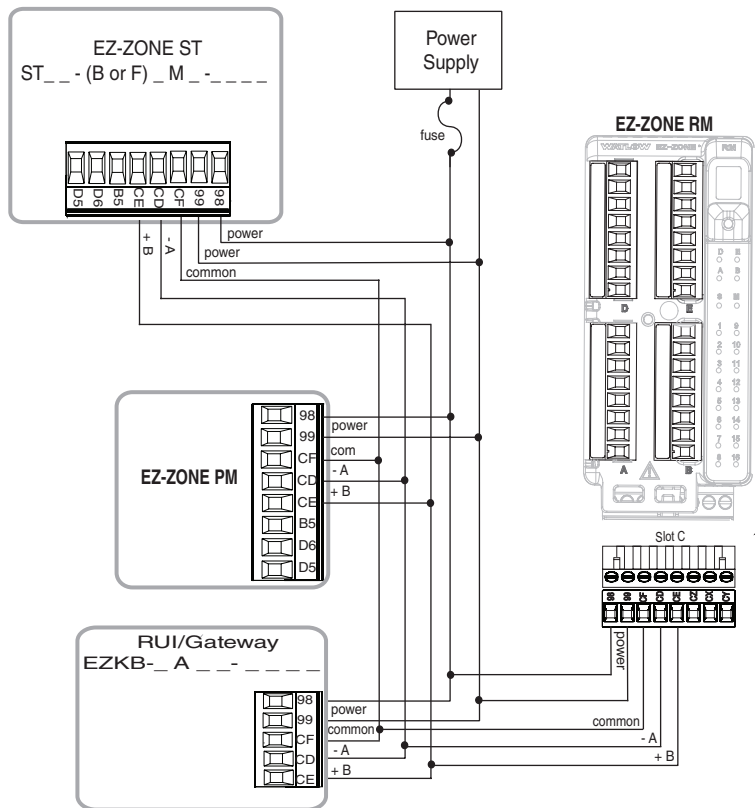

## A Network Using Modbus RTU

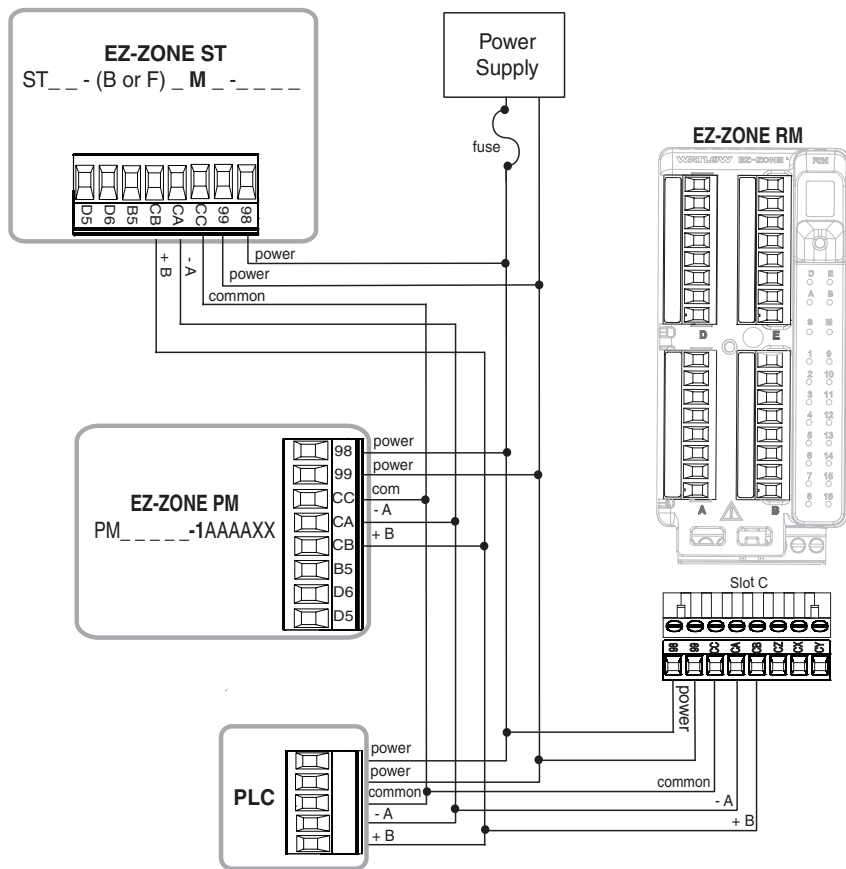

## Connecting a Computer to PM Controls Using B&B 485 to USB Converter

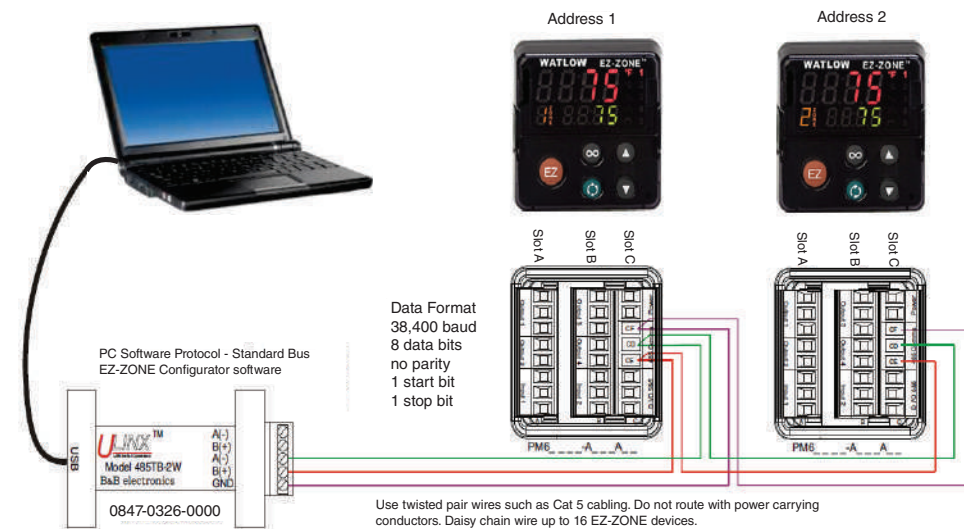

### Note:

Do not leave a USB to EIA-485 converter connected to Standard Bus without power (i.e., disconnecting the USB end from the computer while leaving the converter connected on Standard Bus). Disturbance on the Standard Bus may occur.

**Note:**

When connecting the USB converter to the PC it is suggested that the Latency Timer be changed from the default of 16 msec to 1 msec. Failure to make this change may cause communication loss between the PC running EZ-ZONE Configurator software and the control.

To modify Latency Timer settings follow the steps below:

1. Navigate to Device Manager.
2. Double click on Ports.
3. Right click on the USB serial port in use and select Properties.
4. Click the tab labeled Port settings and then click the Advance button.

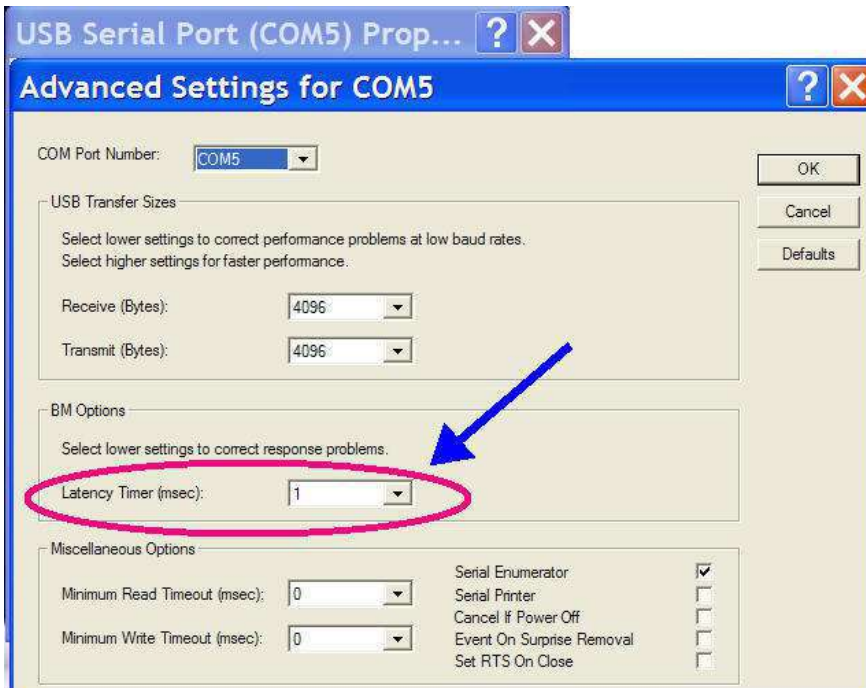

# 3

## Chapter 3: Keys and Displays

### Upper (Left, 32<sup>nd</sup> DIN) Display:

In the Home Page, displays the process value, otherwise displays the value of the parameter in the lower display.

### Zone Display:

Indicates the controller zone.

*i* to *q* = zones 1 to 9

*R* = zone 10 *E* = zone 14

*b* = zone 11 *F* = zone 15

*C* = zone 12 *h* = zone 16

*d* = zone 13

### Percent Units:

Lights when the controller is displaying values as a percentage or when the Manual Power is displayed.

### Channel Display:

Indicates the channel for any given EZ-ZONE module.

- Available with the PM4, 8 and 9 only.

### Infinity Key ∞

Press to back up one level, or press and hold for two seconds to return to the Home Page. From the Home Page clears alarms and errors if clearable.

### Advance Key ↻

Advances through parameter prompts.

### Note:

Upon power up, the upper or left display will briefly indicate the firmware revision and the lower or right display will show PM representing the model.

### 1/32 DIN (PM3)

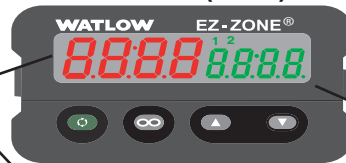

### 1/16 DIN (PM6)

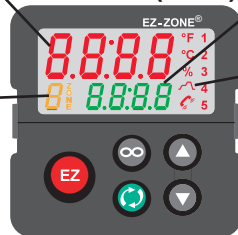

### 1/8 DIN (PM9) Horizontal

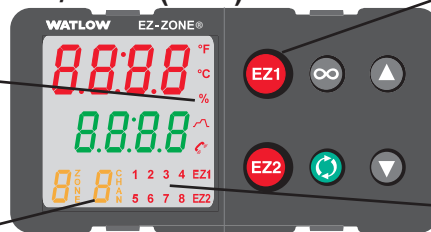

### 1/8 DIN (PM8) Vertical



### 1/4 DIN (PM4)

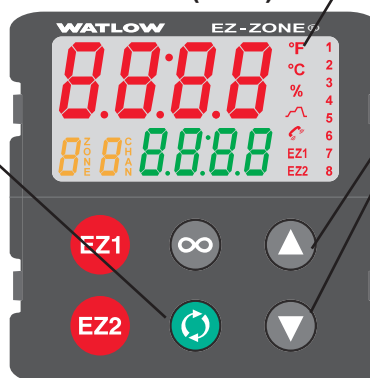

### Lower (Right, 32<sup>nd</sup> DIN) Display:

Indicates the set point or Manual Power value during operation, or the parameter whose value appears in the upper display.

### Profile Activity:

Lights when a profile is running. Flashes when a profile is paused.

### EZ Key/s:

These keys can be programmed to do various tasks, such as starting a profile.

### Output Activity:

Number LEDs indicate activity of outputs. A flashing light indicates output activity.

### Communications Activity

Flashes when another device is communicating with this controller.

### Temperature Units:

Indicates whether the temperature is displayed in Fahrenheit or Celsius.





### Up and Down Keys ▲ ▼







In the Home Page, adjusts the set point in the lower display. In other pages, changes the upper display to a higher or lower value, or changes a parameter selection.

## Responding to a Displayed Message

An active message will cause the display to toggle between the normal settings and the active message in the upper display and *Attn* in the lower display.

Your response will depend on the message and the controller settings. Some messages, such as Ramping and Tuning, indicate that a process is underway. If the message was generated by a latched alarm and the condition no longer exists or if an alarm has silencing enabled it can be silenced simply by pushing the Infinity  key. Alternatively, use the method below to view all and then clear.

Push the Advance Key to display *!gnr* in the upper display and the message source (such as *ALh 1*) in the lower display. Use the Up  or Down  keys to scroll through possible responses, such as Clear *CLr* or Silence *S iL*, then push the Advance  or Infinity  key to execute the action. See the Home Page for further information on the Attention Codes.



Display	Parameter Name Description	Range	Appears If
<i>Attn</i>	<p><b>Attention</b> An active message will cause the display to toggle between the normal settings and the active message in the upper display and <i>Attn</i> in the lower display. Your response will depend on the message and the controller settings. Some messages, such as Ramping and Tuning, indicate that a process is underway. If the message was generated by a latched alarm, the message can be cleared when the condition no longer exists. If an alarm has silencing enabled, it can be silenced.</p> <ol style="list-style-type: none"> <li>1. Push the Advance Key  to display <i>!gnr</i> in the upper display and the message source (such as <i>ALh 1</i>) in the lower display.</li> <li>2. Use the Up  and Down  keys to scroll through possible responses, such as Clear <i>CLr</i> or Silence <i>S iL</i>.</li> <li>3. Press the Advance Key  or Infinity  key to execute the action.</li> </ol> <p>Alternatively, rather than scrolling through all messages simply push the Infinity  button to generate a clear.</p>	<p><i>ALL 1 ALL 2 ALL 3 ALL 4</i> Alarm Low 1 to 4</p> <p><i>ALh 1 ALh 2 ALh 3 ALh 4</i> Alarm High 1 to 4</p> <p><i>ALE 1 ALE 2 ALE 3 ALE 4</i> Alarm Error 1 to 4</p> <p><i>Er. i 1</i> Error Input 1</p> <p><i>tUn 1</i> Tuning 1</p> <p><i>rP 1</i> Ramping 1</p> <p><i>LPo 1</i> Loop Open Error 1</p> <p><i>LP.r 1</i> Loop Reversed Error 1</p> <p><i>uALh</i> Value to high to be displayed in 4 digit LED display &gt;9999</p> <p><i>uALL</i> Value to low to be displayed in 4 digit LED display &lt;-1999</p>	An alarm or error message is active.

# 4

## Chapter 4: Home Page

### Default Home Page Parameters

Watlow's patented user-defined menu system improves operational efficiency. The user-defined Home Page provides you with a shortcut to monitor or change the parameter values that you use most often. The default Home Page is shown on the following page. When a parameter normally located in the Setup Page or Operations Page is placed in the Home Page, it is accessible through both. If you change a parameter in the Home Page, it is automatically changed in its original page. If you change a parameter in its original page it is automatically changed in the Home Page.

Use the Advance Key  to step through the other parameters. When not in pairs, the parameter prompt will appear in the lower display, and the parameter value will appear in the upper display. You can use the Up  and Down  keys to change the value of writable parameters, just as you would in any other menu.

#### Note:

If a writable value is placed on the upper display and is paired with another read only parameter on the lower display, the arrow keys affect the setting of the upper display. If two writable parameters are paired, the arrow keys affect the lower display.

- The Attention *ALLn* parameter appears only if there is an active message. An example of an active message could be a Input Error *Er. i l*, or it could be for information only like Autotune *tUnl* taking place.
- If Control Mode is set to Auto, the Process Value is in the upper display and the Set Point (read-write) is in the lower display.
- If a profile is running, the process value is in the upper display and the Target Set Point (read only) is in the lower display. If Control Mode is set to Manual, the Process Value is in the upper display and Manual Power (read-write) is in the lower display.
- If Control Mode is set to Off, the Process Value is in the upper display and *oFF* (read only) is in the lower display.
- If a sensor failure has occurred, dashes *----* will be displayed in the upper display and the Manual Power (read-write) is in the lower display.



# Navigating the EZ-ZONE<sup>®</sup> PM PID Controller

Applies to All Models - 1/16 DIN Shown Below



**Home Page from anywhere:** Press the Infinity Key ∞ for two seconds to return to the Home Page.

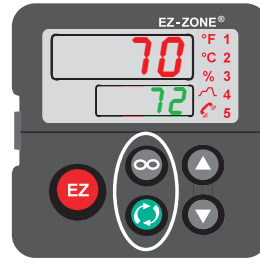
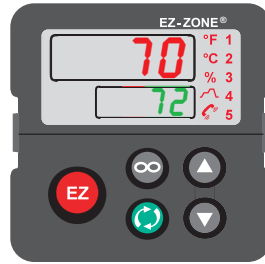

**Factory Page from Home Page:** Press both the Advance ⌚ and Infinity ∞ keys for six seconds.

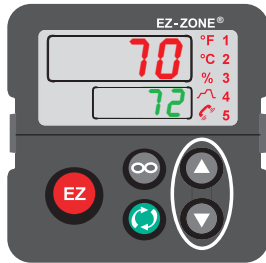

**Operations Page from Home Page:** Press both the Up ▲ and Down ▼ keys for three seconds.

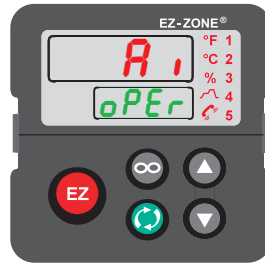

**Setup Page from Home Page:** Press both the Up ▲ and Down ▼ keys for six seconds.



## Note:

Keys must be held continuously until **SEt** is displayed in green. If keys are released when **OPER** is displayed, press the infinity key or reset key to exit and repeat until **SEt** is displayed.









**Profiling Page from Home Page:** Press the Advance Key ⌚ for three seconds.







## Changing the Set Point

You can change the set point by using the Up ▲ or Down ▼ keys when a profile is not running.







## Starting a Profile from the Home Page

1. When at the Home Page, press the Advance Key  to locate Profile Start and select the file or step number to start. The upper display will show *I* and the lower display will show *PSt I*.
2. Press the Up  or Down  key to choose the file or step number.
3. Press the Advance Key  to select the Profile Action Request. The upper display will show *nonE* and the lower display will show *PAC I*.
4. Press the Up  or Down  keys to select the Profile Start. The upper display will show *PrOf* and the lower display will show *PAC I*.
5. Press the Infinity  Key to return Home. The Profile will Start

## Ending a Profile from the Home Page

1. Press the Advance Key  to select the Profile Action Request. The upper display will show *nonE* and the lower display will show *PAC I*.
2. Press the Up  or Down  keys to select the End. The upper display will show *End* and the lower display will show *PAC I*.
3. Press the Infinity  Key to return Home. The Profile will End.

## Modifying the Home Page



1. Push and hold the Advance  key and the Infinity  key for approximately six seconds. Upon entering the Factory Page the first menu will be the Custom Menu *CUSt*.
2. Push the Advance  key where the lower display will show *CUSt* and the upper display will show *I*.
3. Push the Advance  button where the prompt for the Process Value *ACPV* will be displayed on top and Parameter *PAR* in the bottom. There are twenty positions available that can be customized.
4. Pushing the Up  or Down  arrow keys will allow for a customized selection to be made (see list of available parameters below).

Custom Menu Parameter Options	
Description	Prompt *
<b>All Models</b>	
None	Blank
Analog Input Value	<i>Ain I</i>
Cal In Offset	<i>iCA I</i>
Display Units	<i>C_F I</i>
Load Parameter Set	<i>USr.1 USr.2</i>
Alarm Low Set Point	<i>ALo1 ALo2 ALo3 ALo4</i>
Alarm High Set Point	<i>Ah.1 Ah.2 Ah.3 Ah.4</i>
Alarm Hysteresis	<i>AhY1 AhY2 AhY3 AhY4</i>
<b>If 4<sup>th</sup> digit of part number is T</b>	
Time Remaining	<i>t.r</i>
Ready Band State	<i>r.bS</i>
Ready Band	<i>r.dY</i>

Custom Menu Parameter Options	
Description	Prompt *
Closed Loop Timer Set Point	<i>CLSP</i>
Hours	<i>hOUr</i>
Minutes	<i>MIN</i>
Seconds	<i>SEC</i>
If 4 <sup>th</sup> digit of part number is B, E, C, R, J, or N	
Set Point	<i>CSP I</i>
Active Process Value	<i>ACP I</i>
Active Set Point	<i>ACS I</i>
Manual Power	<i>aSP I</i>
Autotune	<i>AUT I</i>
Control Mode	<i>CPM I</i>
Heat Power	<i>hPr I</i>
Cool Power	<i>CPr I</i>
Time Integral	<i>t I I</i>
Time Derivative	<i>t d I</i>
Dead Band	<i>db I</i>
Heat Prop Band	<i>hPb I</i>
On/Off Heat Hysteresis	<i>hhY I</i>
Cool Prop Band	<i>Cpb I</i>
On/Off Cool Hysteresis	<i>chY I</i>
Ramp Rate	<i>r.r t I</i>
TRU-TUNE+ Enable	<i>t.tU I</i>
Idle Set Point	<i>.idS I</i>
If 4 <sup>th</sup> digit of part number is B, E, R or N	
Profile Start	<i>P.St I</i>
Profile Action Request	<i>P.AC I</i>
Current Step	<i>StP</i>
Step Type	<i>StYP</i>
Target Set Point	<i>t.SP I</i>
Produced Set Point	<i>ACSP</i>
Hour	<i>HoUr</i>
Minute	<i>MIN</i>
Second	<i>SEC</i>
Guaranteed Soak Deviation 1	<i>gSd I</i>
Active Event Output 1	<i>Ent I</i>
Active Event Output 2	<i>Ent2</i>

## Modifying the Display Pairs

The Home Page, being a customized list of as many as 20 parameters, can be configured in pairs of up to 10 via the Display Pairs *dPr5* prompt found in the Global Menu *gLBL* (Setup Page). The listing in the table that follows is what one may typically find in the Home Page as defaults based on controller part numbers. It is important to note that some of the prompts shown may not appear simply because the feature is not being used or is turned off. As an example, the prompt shown in position 7 (loop 1) and position 12 (loop 2) *CP* will not appear unless the Cool algorithm *CAG* is turned on in the Setup Page under the Loop menu.

As stated above, the user can define pairs of prompts to appear on the display every time the Advance  key is pushed. The first pair will always be as defined in the Custom Menu and as stated, will default (factory settings) to the Active Process Value loop 1 *ACPu*, and the Active Set Point loop 1 *ACSP*. If two channels are present the first 2 pairs will be the same in that the first pair will represent channel 1 Active Process Value and Active Set Point and the second being the same for channel 2. If another pair is created where the Display Pairs *dPr5* prompt is equal to 3 using the default prompts, when the Advance Key  is pushed two times from the Home Page the upper display will reflect the current control mode and the bottom display would show the output power. When configuring the Custom Menu to your liking it should be noted that if a writable value is placed on the upper display and is paired with another read only parameter on the lower display, the arrow keys will affect the setting of the upper display. Also, if 2 changeable (writable) prompts are displayed in a Pair, i.e., Control Mode on top and Idle Set Point on the bottom, only the lower display (Idle Set Point) can be changed.

The display can be configured to scroll customized pairs by going to the Setup Page under the Global Menu and changing the Display Time *dt*, prompt to something greater than 0 and by changing the Display Pairs *dPr5* to something greater than 1. If the Display Time *dt* is set to 2, the display will toggle every 2 seconds from the first display pair to the second and then the third, etc... The display will continue to toggle through all of the custom pairs at the specified time interval.

When configuring the Custom Menu to your liking, it should be noted that if two writable prompts are displayed in a pair, for example, Control Mode on top and Idle Set Point on the bottom, only the lower display (Idle Set Point) can be changed. If a writable value is placed on the upper display and is paired with another read only parameter on the lower display, the arrow keys affect the setting of the upper display.

	Possible Home Page Defaults (Dependent on Part Number)	Home Page Display	Parameter Page and Menu
<b>All Models</b>			
1	Active Process Value (1)	Numerical value	Operations Page, Monitor Menu
<b>If 4<sup>th</sup> digit of part number is equal to: PM _ [T] _ _ _ - _ _ _ _ _ _ _</b>			
2	Time Remaining (2)	Numerical value	Operations Page, Timer Menu
<b>If 4<sup>th</sup> digit of part number is equal to: PM _ [C, R, B, J, N, E, S] _ _ _ - _ _ _ _ _ _ _</b>			
2	Active Set Point (1)	Numerical value	Operations Page, Monitor Menu
<b>If 4<sup>th</sup> digit of part number is equal to: PM _ [T] _ _ _ - _ _ _ _ _ _ _</b>			
3	Active Set Point (1)	Numerical value	Operations Page, Monitor Menu

	Possible Home Page Defaults (Dependent on Part Number)	Home Page Display	Parameter Page and Menu
If 4 <sup>th</sup> digit of part number is equal to: PM _ [T] _ _ _ - _ _ _ _ _ _ _			
4	Set Point (1)	Numerical value	Operations Page, Monitor Menu
5	Ready State Band (1)	r.b5	Operations Page, Timer Menu
6	Ready Band (1)	r.d4	Operations Page, Timer Menu
7	Closed Loop Timer Set Point (1)	CLSP	Operations Page, Timer Menu
8	Hours (1)	hOUr	Operations Page, Timer Menu
9	Minutes (1)	Min	Operations Page, Timer Menu
10	Seconds (2)	SEC	Operations Page, Timer Menu
If 4 <sup>th</sup> digit of part number is equal to: PM _ [R, B, N, E] _ _ _ - _ _ _ _ _ _ _			
3	Control Mode	CPM	Operations Page, Monitor Menu
4	Heat Power	hPr	Operations Page, Monitor Menu
5	Autotune	AUT	Operations Page, Loop Menu
6	Idle Set Point	idS	Operations Page, Loop Menu
7	Profile Start	PSt	Operations Page, Profile Status
8	Action Request	PAC	Operations Page, Profile Status

**Note:**

The numerical digit shown in the prompts (last digit) and within the parentheses above, represents the parameter instance and can be greater than one.

**Conventions Used in the Menu Pages**

To better understand the menu pages that follow review the naming conventions used. When encountered throughout this document, the word "default" implies as shipped from the factory. Each page (Operations, Setup, Profile and Factory) and their associated menus have identical headers defined below:

Header Name	Definition
Display	Visually displayed information from the control.
Parameter Name	Describes the function of the given parameter.
Range	Defines options available for this prompt, i.e., min/max values (numerical), yes/no, etc... (further explanation below).
Default	Values as delivered from the factory.
Modbus Relative Address	Identifies unique parameters using either the Modbus RTU or Modbus TCP protocols (further explanation below).
CIP (Common Industrial Protocol)	Identifies unique parameters using either the DeviceNet or EtherNet/IP protocol (further explanation below).
Profibus Index	Identifies unique parameters using Profibus DP protocol (further explanation below).
Parameter ID	Identifies unique parameters used with other software such as, LabVIEW.

Header Name	Definition
Data Type R/W	uint = Unsigned 16 bit integer dint = Signed 32-bit, long string = ASCII (8 bits per character) float = IEEE 754 32-bit RWES = Readable Writable EEPROM (saved) User Set (saved)

## Display

Visual information from the control is displayed to the observer using a fairly standard 7 segment display. Due to the use of this technology, several characters displayed need some interpretation, see the list below:

1 = 1	7 = 7	c, C = c	i = i	o = o	u, U = u
2 = 2	8 = 8	d = d	J = J	P = P	v, V = v
3 = 3	9 = 9	E = E	H = K	q = q	W = W
4 = 4	0 = 0	F = F	L = L	r = r	y = y
5 = 5	A = A	g = g	M = M	S = S	Z = Z
6 = 6	b = b	h = h	n = n	t = t	

## Range

Within this column notice that on occasion there will be numbers found within parenthesis. This number represents the enumerated value for that particular selection. Range selections can be made simply by writing the enumerated value of choice using any of the available communications protocols. As an example, turn to the Setup Page and look at the Analog Input **A** menu and then the Sensor Type **5E** prompt. To turn the sensor off using Modbus simply write the value of 62 (off) to register 368 and send that value to the control.

## Modbus RTU Protocols

All Modbus registers are 16-bits and as displayed in this manual are relative addresses (actual). Some legacy software packages limit available Modbus registers to 40001 to 49999 (5 digits). Many applications today require access to all available Modbus registers which range from 400001 to 465535 (6 digits). Watlow controls support 6 digit Modbus registers. For parameters listed as float notice that only one (low order) of the two registers is listed, this is true throughout this document. By default the low order word contains the two low bytes of the 32-bit parameter. As an example, look in the Operations Page for the Process Value. Find the column identified in the header as Modbus and notice that it lists register 360. Because this parameter is a float it is actually represented by registers 360 (low order bytes) and 361 (high order bytes). Because the Modbus specification does not dictate which register should be high or low order, Watlow provides the user the ability to swap this order (Setup Page, **CoP** Menu) from the default low/high **LoHi** to high/low **HiLo**.

### Note:

With the release of firmware revision 7.00 and above new functions were introduced into this product line. With the introduction of these new functions there was a reorganization of Modbus registers. Notice in the column identified as Modbus the reference to Map 1 and Map 2 registers for each of the various parameters. If the new functions, namely; Linearization, Process Value and Real Time Clock are to be used than use Map 2 Modbus regis

ters. The Data Map **MAP** for Modbus registers can be changed in the Setup Page under the **MAP** Menu. This setting will apply across the control.

It should also be noted that some of the cells in the Modbus column contain wording pertaining to an offset. Several parameters in the control contain more than one instance; such as, profiles (4), alarms (4), analog inputs (2), etc... The Modbus register shown always represents instance one. Take for an example the Alarm Silence parameter found in the Setup Page under the Alarm menu. Instance one of Map 1 is shown as address 1490 and +50 is identified as the offset to the next instance. If there was a desire to read or write to instance 3 simply add 100 to 1490 to find its address, in this case, the instance 3 address for Alarm Silence is 1590.

To learn more about the Modbus protocol point your browser to <http://www.modbus.org>.

**Note:**

There are two columns shown in the menus that follow for communications protocols identified as CIP (Common Industrial Protocol) and Profibus. These columns will be useful if this control is used in conjunction with the EZ-ZONE Remote User Interface/Gateway (RUI/GTW) where those protocols can be selected as optional hardware. For this control, as a secondary protocol beyond Standard Bus, Modbus RTU can be ordered as optional hardware.

To learn more about the RUI/GTW point your browser to the link below and search for keyword gateway.

# 5

## Chapter 5: Operations Page

### PM Operation Page Parameters

To navigate to the Operations Page, follow the steps below:

1. From the Home Page, press both the Up ▲ and Down ▼ keys for three seconds. **A I** will appear in the upper display and **oPEr** will appear in the lower display.
2. Press the Up ▲ or Down ▼ key to view available menus.
3. Press the Advance Key ⏩ to enter the menu of choice.
4. If a submenu exists (more than one instance), press the Up ▲ or Down ▼ key to select and then press the Advance Key ⏩ to enter.
5. Press the Up ▲ or Down ▼ key to move through available menu prompts.
6. Press the Infinity Key ∞ to move backwards through the levels: parameter to submenu, submenu to menu, menu to Home Page.
7. Press and hold the Infinity Key ∞ for two seconds to return to the Home Page.

On the following pages, top level menus are identified with a yellow background color.

#### Note:

Some of these menus and parameters may not appear, depending on the controller's options. See model number information in the Appendix for more information. If there is only one instance of a menu, no submenus will appear.

#### Note:

Some of the listed parameters may not be visible. Parameter visibility is dependent upon controller part number.

#### **A I**

##### **oPEr** Analog Input Menu

- A I n** Analog Input Value
- iEr** Input Error
- iCA** Calibration Offset

#### **L n r**

##### **oPEr** Linearization Menu

- S u A** Source Value A
- o F S t** Offset
- o u** Output Value

#### **P u**

##### **oPEr** Process Value Menu

- S u A** Source Value A
- o F S t** Offset
- o u** Output Value

#### **d i o**

##### **oPEr** Digital Input/Output Menu

- S**
- d i o** Digital Input/Output (5 to 6)
- d o S** Output State
- d i S** Input State
- E i S** Event Status

#### **M o n**

##### **oPEr** Monitor Menu

- C n t r l** Control Mode Active
- h P r** Heat Power
- C P r** Cool Power
- C S P** Closed-Loop Set Point
- P u A** Process Value Active



## Loop

### oPEr Loop Menu

*C.M* Control Mode  
*AutSP* Autotune Set Point  
*AUT* Autotune  
*CLSP* Closed Loop Set Point  
*IdS* Idle Set Point  
*hPb* Heat Proportional Band  
*hHy* On/Off Heat Hysteresis  
*CPb* Cool Proportional Band  
*CHy* On/Off Cool Hysteresis  
*tI* Time Integral  
*tD* Time Derivative  
*db* Dead Band  
*oSP* Manual Power

## ALPn

### oPEr Alarm Menu

*1*  
*ALPn* Alarm (1 to 4)  
*ALo* Low Set Point  
*Ahi* High Set Point  
*ACLr* Clear Alarm  
*ASir* Silence Alarm  
*ASt* Alarm State

## tPnr

### oPEr Timer Menu

*SuA* Source Value A  
*SuC* Source Value C  
*SuD* Source Value D  
*PPS1* Produced Set Point 1  
*tEo1* Timer Event Output 1  
*tEo2* Timer Event Output 2  
*tEo3* Timer Event Output 3  
*t.r* Time Remaining  
*r.bS* Ready Band State  
*hoUr* Hours  
*Pn in* Minutes  
*SEC* Seconds  
*CLSP* Closed Loop Timer Set Point

## PStA

### oPEr Profile Status Menu

*PSt.r* Profile Start  
*PACr* Profile Action Request  
*StP* Current Step  
*StYP* Step Type  
*tSP1* Target Set Point Loop 1  
*ACLSP* Produced Set Point 1  
*hoUr* Hours Remaining  
*Pn in* Minutes Remaining  
*SEC* Seconds Remaining  
*Ent1* Active Event Output 1  
*Ent2* Active Event Output 2  
*JC* Jump Count Remaining

**Operations Page**

Display	Parameter Name Description	Range	Default	Modbus Relative Ad- dress	CIP Class Instance Attribute hex (dec)	Pro- fibus Index	Param- eter ID	Data Type and Ac- cess **
<p><b>A i</b> <b>oPEr</b> <b>Analog Input Menu</b></p>								
<b>A in</b> Ain	<p><i>Analog Input</i> <b>Analog Input Value</b> View the process value.</p> <p><b>Note:</b> Ensure that the Input Error (below) indicates no error (61) when reading this value using a field bus protocol. If an error exists, the last known value prior to the error occurring will be returned.</p>	-1,999.000 to 9,999.000°F or units -1,128.000 to 5,537.000°C	- - - -	<p><b>Instance 1</b> Map 1    Map 2 360      360</p>	0x68 (104) 1 1	0	4001	float R
<b>i.Er</b> i.Er	<p><i>Analog Input</i> <b>Input Error</b> View the cause of the most recent error. If the <b>AttEn</b> message is <b>Err.11</b> or <b>Err.12</b>, this parameter will display the cause of the input error.</p>	<p><b>none</b> None (61) <b>Open</b> Open (65) <b>Short</b> Shorted (127) <b>ErrM</b> Measurement Error (140) <b>ECAL</b> Bad Calibration Data (139) <b>ErrAb</b> Ambient Error (9) <b>Errtd</b> RTD Error (141) <b>Fail</b> Fail (32) <b>NotSrc</b> Not Sourced (246)</p>	- - - -	<p><b>Instance 1</b> Map 1    Map 2 362      362</p>	0x68 (104) 1 to 2 2	1	4002	uint R
<b>i.CA</b> i.CA	<p><i>Analog Input</i> <b>Calibration Offset</b> Offset the input reading to compensate for lead wire resistance or other factors that cause the input reading to vary from the actual process value.</p>	-1,999.000 to 9,999.000°F or units -1,110.555 to 5,555.000°C	0.0	<p><b>Instance 1</b> Map 1    Map 2 382      382</p>	0x68 (104) 1 to 2 0xC (12)	2	4012	float RWES
<p>** R: Read, W: Write, E: EEPROM, S: User Set</p>								

## Operations Page

Display	Parameter Name Description	Range	Default	Modbus Relative Ad- dress	CIP Class Instance Attribute hex (dec)	Pro- fibus Index	Param- eter ID	Data Type and Ac- cess **
<p><i>Lnr</i> <i>oPEr</i> <b>Linearization Menu</b></p>								
<i>Su.A</i> Su.A	<b>Linearization Source Value A</b> View the value of Source A. Source A of Lineariza- tion 1 is connected to Analog Input 1, Source A of Linearization 2 is connected to Analog Input 2	-1,999.000 to 9,999.000°F or units -1,128.000 to 5,537.000°C	----	<b>Instance 1</b> Map 1 Map 2 ---- 3566	0x86 (134) 1 4	----	34004	float R
<i>oFSt</i> oFSt	<b>Linearization Offset</b> Set an offset to be applied to this func- tion's output.	-1,999.000 to 9,999.000°F or units -1,128.000 to 5,537.000°C	0	<b>Instance 1</b> Map 1 Map 2 ---- 3570	0x86 (134) 1 to 2 6	----	34006	float RWES
<i>o.v</i> o.v	<b>Linearization Output Value</b> View the value of this function's output.	-1,999.000 to 9,999.000°F or units -1,128.000 to 5,537.000°C	----	<b>Instance 1</b> Map 1 Map 2 ---- 3572	0x86 (134) 1 to 2 7	----	34007	float R
No Dis- play	<b>Linearization Error</b> View reported cause for Linearization out- put malfunction.	None (61) Open (65) Shorted (127) Measurement error (140) Bad calibration data (139) Ambient error (9) RTD error (14) Fail (32) Math error (1423) Not sourced (246) Stale (1617) Can't process (1659)	----	<b>Instance 1</b> Map 1 Map 2 ---- 3614	0x86 (134) 1 to 2 0x1C (28)	----	34028	uint R
** R: Read, W: Write, E: EEPROM, S: User Set								

## Operations Page

Display	Parameter Name Description	Range	Default	Modbus Relative Address	CIP Class Instance Attribute hex (dec)	Pro-fibus Index	Parameter ID	Data Type and Access **
<b>Pu</b> <b>oPEr</b> <b>Process Value Menu</b>								
<b>SuA</b> Su.A	<b>Process Value Source Value A</b> View the value of Source A. Linearization 1 is connected to Source A of Process Value 1.	-1,999.000 to 9,999.000°F or units -1,128.000 to 5,537.000°C	- - - -	<b>Instance 1</b> Map 1 Map 2 - - - - 3310	0x7E (126) 1 0x10 (16)	- - - -	26016	float R
<b>oFSt</b> oFSt	<b>Process Value Offset</b> Set an offset to be applied to this function's output.	-1,999.000 to 9,999.000°F or units -1,128.000 to 5,537.000°C	0	<b>Instance 1</b> Map 1 Map 2 - - - - 3324	0x7E (126) 1 0x17 (23)	- - - -	26023	float RWES
<b>o.u</b> o.u	<b>Process Value Output Value</b> View the value of this function block's output.	-1,999.000 to 9,999.000°F or units -1,128.000 to 5,537.000°C	- - - -	<b>Instance 1</b> Map 1 Map 2 - - - - 3322	0x7E (126) 1 0x16 (22)	- - - -	26022	float R
No Display	<b>Process Value Output Error</b> View reported cause for Process output malfunction.	None (61) Open (65) Shorted (127) Measurement error (140) Bad calibration data (139) Ambient error (9) RTD error (14) Fail (32) Math error (1423) Not sourced (246) Stale (1617) Can't process (1659)	- - - -	<b>Instance 1</b> Map 1 Map 2 - - - - 3332	0x7E (126) (134) 1 0x1B (27)	- - - -	26027	uint R
<b>d io</b> <b>oPEr</b> <b>Digital Input/Output Menu</b>								
<b>do.S</b> do.S	<b>Digital Output (5 to 6) Output State</b> View the state of this output.	<b>oFF</b> Off (62) <b>oN</b> On (63)	- - - -	<b>Instance 5</b> Map 1 Map 2 1012 1132 Offset to next instance equals +30	0x6A (106) 5 to 12 7	46	6007	uint R
** R: Read, W: Write, E: EEPROM, S: User Set								

## Operations Page

Display	Parameter Name Description	Range	Default	Modbus Relative Ad- dress	CIP Class Instance Attribute hex (dec)	Pro- fibus Index	Param- eter ID	Data Type and Ac- cess **
<b>d.i.S</b> di.S	<b>Digital Input (5 to 6) Input State</b> View this event input state.	<b>oFF</b> Off (62) <b>oN</b> On (63)	----	<b>Instance 5</b> Map 1 Map 2 1020 1140 Offset to next instance equals +30	0x6A (106) 5 to 12 0x0B (11)	----	6011	uint R
<b>E.i.S</b> Ei.S	<b>Digital Input (5 to 6) Event Status</b> View this event input state.	<b>,AcE</b> Inactive (41) <b>AcE</b> Active (5)	----	<b>Instance 5</b> Map 1 Map 2 1408 1648 Offset to next instance equals +20	0x6E (110) 5 to 6 5	140	10005	uint R
No Dis- play	<b>EZ-Key/s (1 to 2) Event Status</b> View this event input state.	<b>,AcE</b> Inactive (41) <b>AcE</b> Active (5)	----	<b>Instance 1</b> Map 1 Map 2 1328 1568 Offset to next instance equals +20	0x6E (110) 1 to 2 5	140	10005	uint R
<b>Monitor Menu</b>								
<b>C.MA</b> C.MA	<b>Monitor Control Mode Active</b> View the current con- trol mode.	<b>oFF</b> Off (62) <b>AUTO</b> Auto (10) <b>MAN</b> Manual (54)	----	<b>Instance 1</b> Map 1 Map 2 1882 2362 1 2	0x97 (151) 1 2	----	8002	uint R
<b>h.Pr</b> h.Pr	<b>Monitor Heat Power</b> View the current heat output level.	0.0 to 100.0%	----	<b>Instance 1</b> Map 1 Map 2 1904 2384 1	0x97 (151) 1 0xD (13)	----	8011	float R
<b>C.Pr</b> C.Pr	<b>Monitor Cool Power</b> View the current cool output level.	-100.0 to 0.0%	----	<b>Instance 1</b> Map 1 Map 2 1906 2386 1	0x97 (151) 1 0xE (14)	----	8014	float R
<b>C.SP</b> C.SP	<b>Monitor Closed-Loop Set Point</b> View the working set point currently in ef- fect.	-1,999.000 to 9,999.000 °F or units -1,128.000 to 5,537.000 °C	----	----	----	----	8029	float R
<b>Pv.A</b> Pv.A	<b>Monitor Process Value Active</b> View the current fil- tered process value us- ing the control input.	-1,999.000 to 9,999.000 °F or units -1,128.000 to 5,537.000 °C	----	<b>Instance 1</b> Map 1 Map 2 402 402 1	0x68 (104) 1 0x16 (22)	----	8031	float R
** R: Read, W: Write, E: EEPROM, S: User Set								

## Operations Page

Display	Parameter Name Description	Range	Default	Modbus Relative Address	CIP Class Instance Attribute hex (dec)	Pro-fibus Index	Parameter ID	Data Type and Access **
No Display	<i>Monitor</i> <b>Set Point Active</b> Read the current active set point.	-1,999.000 to 9,999.000°F or units -1,128.000 to 5,537.000°C	- - - -	<b>Instance 1</b> Map 1    Map 2 2172    2652	0x6B (107) 1 7	- - - -	8031	float R
No Display	<i>Monitor</i> <b>Autotune Status</b> Read the present status of Autotune.	Off (62) Waiting for cross 1 positive (119) Waiting for cross 1 negative (120) Waiting for cross 2 positive (121) Waiting for cross 2 negative (122) Waiting for cross 3 positive (123) Waiting for cross 3 negative (150) Measuring maximum peak (151) Measuring minimum peak (152) Calculating (153) Complete (18) Timeout (118)	- - - -	<b>Instance 1</b> Map 1    Map 2 1932    2412	0x97 (151) 1 0x1B (27)	- - - -	8027	uint R
<p><i>LoOp</i> <i>oPEr</i> <b>Control Loop Menu</b></p>								
<i>CP7</i> C.M	<i>Control Loop (1 to 2)</i> <b>Control Mode</b> Select the method that this loop will use to control.	<i>oFF</i> Off (62) <i>Auto</i> Auto (10) <i>MAN</i> Manual (54)	Auto	<b>Instance 1</b> Map 1    Map 2 1880    2360	0x97 (151) 1 1	63	8001	uint RWES
<i>ALSP</i> A.tSP	<i>Control Loop</i> <b>Autotune Set Point</b> Set the set point that the autotune will use, as a percentage of the current set point.	50.0 to 200.0%	90.0	<b>Instance 1</b> Map 1    Map 2 1918    2398	0x97 (151) 1 0x14 (20)	- - - -	8025	float RWES

\*\* R: Read, W: Write, E: EEPROM, S: User Set

## Operations Page

Display	Parameter Name Description	Range	Default	Modbus Relative Ad- dress	CIP Class Instance Attribute hex (dec)	Pro- fibus Index	Param- eter ID	Data Type and Ac- cess **
<b>AUT</b> AUT	<b>Control Loop Autotune</b> Start an autotune. While the autotune is active, the Home Page will display <b>Auton Tune!</b> . When the autotune is complete, the message will clear automatically.	<b>no</b> No (59) <b>YES</b> Yes (106)	No	<b>Instance 1</b> Map 1 Map 2 1920 2400	0x97 (151) 1 0x15 (21)	64	8026	uint RW
<b>C.SP</b> C.SP	<b>Control Loop Set Point</b> Set the closed loop set point that the controller will automatically control to.	Low Set Point to Maximum Set Point (Setup Page)	75.0°F or units 24.0°C	<b>Instance 1</b> Map 1 Map 2 2160 2640	0x6B (107) 1 1	49	7001	float RWES
<b>id.S</b> id.S	<b>Control Loop Idle Set Point</b> Define a set point that can be triggered by an event state.	Low Set Point to High Set Point (Setup Page)	75.0°F or units 24.0°C	<b>Instance 1</b> Map 1 Map 2 2176 2656	0x6B (107) 1 9	50	7009	float RWES
<b>h.Pb</b> h.Pb	<b>Control Loop Heat Proportional Band</b> Set the PID proportional band for the heat outputs.	0.001 to 9,999.000°F or units 0.001 to 5,555.000°C	25.0°F or units 14.0°C	<b>Instance 1</b> Map 1 Map 2 1890 2370	0x97 (151) 1 6	65	8009	float RWES
<b>h.hy</b> h.hy	<b>Control Loop On/Off Heat Hyster- esis</b> Set the control switching hysteresis for on-off control. This determines how far into the "on" region the process value needs to move before the output turns on.	0.001 to 9,999.000°F or units 0.001 to 5,555.000°C	3.0°F or units 2.0°C	<b>Instance 1</b> Map 1 Map 2 1900 2380	0x97 (151) 1 0xB (11)	66	8010	float RWES
<b>C.Pb</b> C.Pb	<b>Control Loop Cool Proportional Band</b> Set the PID proportional band for the cool outputs.	0.001 to 9,999.000°F or units 0.001 to 5,555.000°C	25.0°F or units 14.0°C	<b>Instance 1</b> Map 1 Map 2 1892 2372	0x97 (151) 1 7	67	8012	float RWES

\*\* R: Read, W: Write, E: EEPROM, S: User Set

## Operations Page

Display	Parameter Name Description	Range	Default	Modbus Relative Address	CIP Class Instance Attribute hex (dec)	Pro-fibus Index	Parameter ID	Data Type and Access **
<b>C.hy</b> C.hy	<b>Control Loop On/Off Cool Hysteresis</b> Set the control switching hysteresis for on-off control. This determines how far into the "on" region the process value needs to move before the output turns on.	0.001 to 9,999.000 °F or units 0.001 to 5,555.000 °C	3.0 °F or units 2.0 °C	<b>Instance 1</b> Map 1 Map 2 1902 2382	0x97 (151) 1 0xC (12)	68	8013	float RWES
<b>t.i</b> ti	<b>Control Loop Time Integral</b> Set the PID integral for the outputs.	0 to 9,999 seconds per repeat	180 seconds per repeat	<b>Instance 1</b> Map 1 Map 2 1894 2374	0x97 (151) 1 8	69	8006	float RWES
<b>t.d</b> td	<b>Control Loop Time Derivative</b> Set the PID derivative time for the outputs.	0 to 9,999 seconds	0 seconds	<b>Instance 1</b> Map 1 Map 2 1896 2376	0x97 (151) 1 9	70	8007	float RWES
<b>db</b> db	<b>Control Loop Dead Band</b> Set the offset to the proportional band. With a negative value, both heating and cooling outputs are active when the process value is near the set point. A positive value keeps heating and cooling outputs from fighting each other.	-1,000.0 to 1,000.0 °F or units -556 to 556 °C	0.0	<b>Instance 1</b> Map 1 Map 2 1898 2378	0x97 (151) 1 0xA (10)	71	8008	float RWES
<b>o.SP</b> o.SP	<b>Control Loop Manual Power</b> Set a fixed level of output power when in manual (open-loop) mode.	-100 to 100% (heat and cool) 0 to 100% (heat only) -100 to 0% (cool only)	0.0	<b>Instance 1</b> Map 1 Map 2 2162 2642	0x6B (107) 1 2	51	7002	float RWES
No Display	<b>Control Loop Loop Error</b> Open Loop detect deviation has been exceeded.	<b>nonE</b> None (61) <b>L.P.o</b> Open Loop (1274) <b>L.P.r</b> Reversed Sensor (1275)	- - - -	<b>Instance 1</b> Map 1 Map 2 1928 2408	0x6C (108) 1 0x30 (48)	- - - -	8048	uint R
No Display	<b>Control Loop Clear Loop Error</b> Current state of limit output.	<b>CLr</b> Clear (129) <b>Ignr</b> Ignore (204)	- - - -	<b>Instance 1</b> Map 1 Map 2 1930 2410	0x6C (108) 1 0x31 (49)	- - - -	8049	uint W
** R: Read, W: Write, E: EEPROM, S: User Set								



## Operations Page

Display	Parameter Name Description	Range	Default	Modbus Relative Ad- dress	CIP Class Instance Attribute hex (dec)	Pro- fibus Index	Param- eter ID	Data Type and Ac- cess **
No Dis- play	Control Loop Loop Output Power View the loop output power.	-100.0 to 100.0	- - - -	<i>Instance 1</i> Map 1    Map 2 1908    2388	0x97 (151) 1 0x0F (15)	- - - -	8033	float R

ALM

OPER

### Alarm Menu

ALo A.Lo	<p><i>Alarm (1 to 4)</i> <b>Low Set Point</b> If Type (Setup Page, Alarm Menu) is set to:</p> <p><b>Process</b> - set the pro- cess value that will trigger a low alarm.</p> <p><b>Deviation</b> - set the span of units from the set point that will trigger a low alarm. A negative set point rep- resents a value below closed loop set point. A positive set point rep- resents a value above closed loop set point.</p>	-1,999.000 to 9,999.000°F or units -1,128.000 to 5,537.000°C	32.0°F or units 0.0°C	<p><i>Instance 1</i> Map 1    Map 2 1482    1882</p> <p>Offset to next in- stance (Map 1) equals +50</p> <p>Offset to next in- stance (Map 2) equals +60</p>	0x6D (109) 1 to 24 2	18	9002	float RWES
Ahi A.hi	<p><i>Alarm (1 to 4)</i> <b>High Set Point</b> If Type (Setup Page, Alarm Menu) is set to:</p> <p><b>Process</b> - set the pro- cess value that will trigger a high alarm.</p> <p><b>Deviation</b> - set the span of units from the set point that will trigger a low alarm. A negative set point rep- resents a value below closed loop set point. A positive set point rep- resents a value above closed loop set point.</p>	-1,999.000 to 9,999.000°F or units -1,128.000 to 5,537.000°C	300.0 °F or units 150.0 °C	<p><i>Instance 1</i> Map 1    Map 2 1480    1880</p> <p>Offset to next in- stance (Map 1) equals +50</p> <p>Offset to next in- stance (Map 2) equals +60</p>	0x6D (109) 1 to 4 1	19	9001	float RWES

\*\* R: Read, W: Write, E: EEPROM, S: User Set

## Operations Page

Display	Parameter Name Description	Range	Default	Modbus Relative Address	CIP Class Instance Attribute hex (dec)	Pro-fibus Index	Parameter ID	Data Type and Access **
<b>RCLr</b> A.CLr	<b>Alarm (1 to 4) Clear Alarm</b> Write to this register to clear an alarm	<b>CLr</b> Clear (1003) <b>Ignr</b> Ignore (204)	----	<b>Instance 1</b> Map 1 Map 2 1504 1904  Offset to next instance (Map1 1 equals +50, Map 2 equals +60)	0x6D (109) 1 to 4 0x0D (13)	----	9026	uint W
<b>RSir</b> A.Sir	<b>Alarm (1 to 4) Silence Alarm</b> Write to this register to silence an alarm	<b>Sir</b> Silence (1010)		<b>Instance 1</b> Map 1 Map 2 1506 1906  Offset to next instance (Map1 1 equals +50, Map 2 equals +60)	0x6D (109) 1 to 4 0x0E (14)	----	9027	uint W
<b>RSt</b> A.St	<b>Alarm (1 to 4) State</b> Current state of alarm	Startup (88) None (61) Blocked (12) Alarm low (8) Alarm high (7) Error (28)	----	<b>Instance 1</b> Map 1 Map 2 1496 1896  Offset to next instance (Map1 1 equals +50, Map 2 equals +60)	0x6D (109) 1 to 2 9	----	9009	uint R
No Display	<b>Alarm (1 to 4) Alarm Clearable</b> Indicates if alarm can be cleared.	No (59) Yes (106)	----	<b>Instance 1</b> Map 1 Map 2 1502 1902  Offset to next instance (Map1 1 equals +50, Map 2 equals +60)	0x6D (109) 1 to 4 0xC (12)	----	9012	uint R
No Display	<b>Alarm (1 to 4) Alarm Silenced</b> Indicates if alarm is silenced.	No (59) Yes (106)	----	<b>Instance 1</b> Map 1 Map 2 1500 1900  Offset to next instance (Map1 1 equals +50, Map 2 equals +60)	0x6D (109) 1 to 4 0x0B (11)	----	9011	uint R

\*\* R: Read, W: Write, E: EEPROM, S: User Set

## Operations Page

Display	Parameter Name Description	Range	Default	Modbus Relative Ad- dress	CIP Class Instance Attribute hex (dec)	Pro- fibus Index	Param- eter ID	Data Type and Ac- cess **
No Dis- play	<i>Alarm (1 to 4)</i> <b>Alarm Latched</b> Indicates if alarm is latched.	No (59) Yes (106)	----	<b>Instance 1</b> Map 1 Map 2 1498 1898  Offset to next in- stance (Map1 1 equals +50, Map 2 equals +60)	0x6D (109) 1 to 4 0x0A (10)	----	9010	uint R
<p style="color: red; margin: 0;">tPPr</p> <p style="color: green; margin: 0;">oPEr</p> <p><b>Timer Menu</b></p>								
<span style="color: green;">Su.A</span> Su.A	<i>Timer</i> <b>Source Value A</b> View the state of Source Function A.	<span style="color: red;">on</span> On (63) <span style="color: red;">oFF</span> Off (62)	----	<b>Instance 1</b> Map 1 Map 2 4582 8012	0x83 (109) 1 0x07 (7)	----	31007	uint R
<span style="color: green;">Su.C</span> Su.C	<i>Timer (1)</i> <b>Source Value C</b> View the value of Source Function C.	-1999.000 to 999.000 °F or units -1110.555 to 5555.000	----	<b>Instance 1</b> Map 1 Map 2 4642 8572	0x83 (109) 1 0x25 (37)	----	31037	float R
<span style="color: green;">Su.d</span> Su.d	<i>Timer (1)</i> <b>Source Value D</b> View the state of Source Function D.	<span style="color: red;">on</span> On (63) <span style="color: red;">oFF</span> Off (62)	----	<b>Instance 1</b> Map 1 Map 2 4644 8574	0x83 (109) 1 0x26 (38)	----	31038	uint R
<span style="color: green;">P.SP 1</span> P.SP1	<i>Timer (1)</i> <b>Produced Set Point 1</b> View the value of Set Point 1.	-1999.000 to 999.000 °F or units -1110.555 to 5555.000	----	<b>Instance 1</b> Map 1 Map 2 4646 8576	0x83 (109) 1 0x27 (39)	----	31039	float R
<span style="color: green;">tE.o1</span> tE.o1	<i>Timer (1)</i> <b>Timer Event Output 1</b> View the state of Event Output 1.	<span style="color: red;">on</span> On (63) <span style="color: red;">oFF</span> Off (62)	----	<b>Instance 1</b> Map 1 Map 2 4648 8578	0x83 (109) 1 0x28 (40)	----	31040	uint R
<span style="color: green;">tE.o2</span> tE.o2	<i>Timer (1)</i> <b>Timer Event Output 2</b> View the state of Event Output 2.	<span style="color: red;">on</span> On (63) <span style="color: red;">oFF</span> Off (62)	----	<b>Instance 1</b> Map 1 Map 2 4650 8580	0x83 (109) 1 0x29 (41)	----	31041	uint R
<span style="color: green;">tE.o3</span> tE.o3	<i>Timer (1)</i> <b>Timer Event Output 3</b> View the state of Event Output 3.	<span style="color: red;">on</span> On (63) <span style="color: red;">oFF</span> Off (62)	----	<b>Instance 1</b> Map 1 Map 2 4662 8590	0x83 (109) 1 0x2E (46)	----	31046	uint R

\*\* R: Read, W: Write, E: EEPROM, S: User Set

## Operations Page

Display	Parameter Name Description	Range	Default	Modbus Relative Address	CIP Class Instance Attribute hex (dec)	Pro-fibus Index	Parameter ID	Data Type and Access **
t.r	<b>Timer Time Remaining</b> Display the time remaining on the timer.	00:00 00:00 to 99:59	7	Instance 1 Map 1 Map 2 -----	0x83 (131) 1 0x15 (21)	----	31021	string R
r.bS	<b>Timer Ready Band State</b> Display whether the process value is in the ready band.	YES Yes (106) NO No (59)	----	Instance 1 Map 1 Map 2 4612 8542	0x83 (131) 1 0x16 (22)	----	31022	uint R
hoUr	<b>Timer Hours</b> Set the timer period hours.	0 to 99	0	Instance 1 Map 1 Map 2 4618 8548	0x83 (131) 1 0x19 (25)	----	31025	uint RWES
Min	<b>Timer Minutes</b> Set the timer period minutes.	0 to 59	0	Instance 1 Map 1 Map 2 4620 8550	0x83 (131) 1 0x1A (26)	----	31026	uint RWES
SEC	<b>Timer Seconds</b> Set the timer period seconds.	0 to 59	10	Instance 1 Map 1 Map 2 4622 8552	0x83 (131) 1 0x1B (27)	----	31027	uint RWES
Ct.SP	<b>Timer Closed Loop Timer Set Point</b> Set the set point that will be in effect during the timer period.	-1999.000 to 9999.000°F or units -1110.555 to 5555.000°C	75	Instance 1 Map 1 Map 2 4624 8554	0x83 (131) 1 0x1C (28)	----	31028	float RWES
No Display	<b>Timer Timer Timing</b> Indicates whether the timer is running.	On (63) Off (62)	----	Instance 1 Map 1 Map 2 4598 8528	0x83 (131) 1 0x0F (15)	----	31015	uint R
No Display	<b>Timer Output Error</b> Indicates errors that may have interfered with the timer operation.	None (61) Open (65) Shorted (127) Measurement Error (140) Bad Calibration Data (139) Ambient Error (9) RTD Error (141) Fail (32) Math Error (1423) Not Sourced (246) Stale (1617)	----	Instance 1 Map 1 Map 2 4604 8534	0x83 (131) 1 0x12 (18)	----	31018	uint R

\*\* R: Read, W: Write, E: EEPROM, S: User Set

## Operations Page

Display	Parameter Name Description	Range	Default	Modbus Relative Ad- dress	CIP Class Instance Attribute hex (dec)	Pro- fibus Index	Param- eter ID	Data Type and Ac- cess **
No Dis- play	<i>Timer</i> <b>Indicator Request</b> View the status of the timer illuminated indicators.	Off (62) Ready (1662) Ready Ack (1950) Running (149)	----	<i>Instance 1</i> Map 1    Map 2 4652    8582	0x83 (131) 1 0x2A (42)	----	31042	uint R
No Dis- play	<i>Timer</i> <b>Countdown State</b> View the state of the countdown cycle.	Inactive (41) Wait Process (209) Wait Event (144) Running (149) Pause (146) Complete (18) End (27)	----	<i>Instance 1</i> Map 1    Map 2 4654    8584	0x83 (131) 1 0x2B (43)	----	31043	uint R
No Dis- play	<i>Timer</i> <b>Elapsed Signal Time</b> Counts from 0 to Signal Time while signal time is active.	0 to 4,294,967,295 mS	----	<i>Instance 1</i> Map 1    Map 2 4662    8592	0x83 (131) 1 0x2F (47)	----	31047	udint R
No Dis- play	<i>Timer</i> <b>Elapsed Time</b> Counts from 0 to Count-down Time while time cycle is active.	0 to 4,294,967,295 mS	----	<i>Instance 1</i> Map 1    Map 2 4664    8594	0x83 (131) 1 0x30 (48)	----	31048	udint R
<b>P.S.T.R</b> <b>o.P.E.r</b> <b>Profile Status Menu</b>		<p>* Available with PM8/9 only.</p> <p>* Some parameters in the Profile Status Menu can be changed for the currently running profile, but should only be changed by knowledgeable personnel and with caution. Changing parameters via the Profile Status Menu will not change the stored profile but will have an immediate impact on the profile that is running. Changes made to profile parameters in the Profiling Pages will be saved and will also have an immediate impact on the running profile.</p>						
<b>P.S.T.r</b> P.Str	<i>Profile Status</i> <b>Profile Start</b>	1 to 40	1	<i>Instance 1</i> Map 1    Map 2 2520    4340	0x7A (122) 1 1	204	22001	uint W
<b>P.A.C.r</b> PACr	<i>Profile Status</i> <b>Action Request</b>	<b>n.o.n.E</b> None (61) <b>S.T.E.P</b> Step (89) <b>E.n.d</b> Terminate (148) <b>r.E.S.U</b> Resume (147) <b>P.A.U.S</b> Pause (146) <b>P.r.o.F</b> Profile (77)	None	<i>Instance 1</i> Map 1    Map 2 2540    4360	0x7A (122) 1 0xB (11)	205	22011	uint W
<b>S.T.P</b> StP	<i>Profile Status</i> <b>Current Step</b> View the currently running step.	1 to 40 0 (none)	----	<i>Instance 1</i> Map 1    Map 2 2526    4346	0x7A (122) 1 4	----	22004	uint R
** R: Read, W: Write, E: EEPROM, S: User Set								

## Operations Page

Display	Parameter Name Description	Range	Default	Modbus Relative Address	CIP Class Instance Attribute hex (dec)	Pro-fibus Index	Parameter ID	Data Type and Access **
<b>STEP</b> S.typ	<b>Profile Status Step Type</b> View the currently running step type.	<b>USEP</b> Unused Step (50) <b>SOAKH</b> Soak (87) <b>WTE</b> Wait For Event (144) <b>WTPR</b> Wait For Process (209) <b>WTBO</b> Wait For Process or Event (210) <b>JL</b> Jump (116) <b>END</b> End (27) <b>CLoC</b> Wait For Time (1543) <b>ET</b> Time (143) <b>RATE</b> Ramp Rate (81)	- - - -	<b>Instance 1</b> Map 1 Map 2 2544 4364	0x7A (122) 1 0xD (13)	- - - -	22013	uint R
<b>TEMP1</b> t.SP1	<b>Profile Status *Target Set Point Loop 1</b> View or change the target set point of the current step.	-1,999.000 to 9,999.000°F or units -1,128.000 to 5,537.000°C	0.0°F or units -18.0°C	<b>Instance 1</b> Map 1 Map 2 2542 4362	0x7A (122) 1 0xC (12)	- - - -	22012	float RW
<b>TEMP2</b> t.SP2	<b>Profile Status *Target Set Point Loop 2</b> View or change the target set point of the current step.	-1,999.000 to 9,999.000°F or units -1,128.000 to 5,537.000°C	0.0°F or units -18.0°C	<b>Instance 1</b> Map 1 Map 2 - - - - 4434	0x7A (122) 1 0x30 (48)	- - - -	22048	float RW
<b>AC.SP</b> AC.SP	<b>Profile Status Produced Set Point 1</b> Display the current set point, even if the profile is ramping.	-1,999.000 to 9,999.000°F or units -1,128.000 to 5,537.000°C	- - - -	<b>Instance 1</b> Map 1 Map 2 2528 4348	- - - -	- - - -	22005	float R
<b>P.SP2</b> P.SP2	<b>Profile Status Produced Set Point 2</b> Display the current set point, even if the profile is ramping.	-1,999.000 to 9,999.000°F or units -1,128.000 to 5,537.000°C	- - - -	<b>Instance 1</b> Map 1 Map 2 - - - - 4440	- - - -	- - - -	22051	float R
<b>hour</b> hoUr	<b>Profile Status Hours</b> Step time remaining in hours.	0 to 9999	0	<b>Instance 1</b> Map 1 Map 2 - - - - 4494	0x7A (122) 1 0x4E (78)	- - - -	22078	uint RW

\*\* R: Read, W: Write, E: EEPROM, S: User Set

## Operations Page

Display	Parameter Name Description	Range	Default	Modbus Relative Ad- dress	CIP Class Instance Attribute hex (dec)	Pro- fibus Index	Param- eter ID	Data Type and Ac- cess **
<b>Min</b> Min	<i>Profile Status</i> <b>Minutes</b> Step time remaining in minutes.	0 to 59	0	<b>Instance 1</b> Map 1 Map 2 - - - - 4492	0x7A (122) 1 0x4D (77)	- - - -	22077	uint RW
<b>SEC</b> SEC	<i>Profile Status</i> <b>Seconds</b> Step time remaining in seconds.	0 to 59	0	<b>Instance 1</b> Map 1 Map 2 - - - - 4490	0x7A (122) 1 0x4C (76)	- - - -	22076	uint RW
<b>Ent1</b> Ent1	<i>Profile Status</i> <b>*Event 1</b> View or change the event output states.	<b>oFF</b> Off (62) <b>oN</b> On (63)	Off	<b>Instance 1</b> Map 1 Map 2 2546 4366	0x7A (122) 1 0xE (14)	- - - -	22014	uint RW
<b>Ent2</b> Ent2	<i>Profile Status</i> <b>*Event 2</b> View or change the event output states.	<b>oFF</b> Off (62) <b>oN</b> On (63)	Off	<b>Instance 1</b> Map 1 Map 2 2548 4368	0x7A (122) 1 0xF (15)	- - - -	22015	uint RW
<b>JC</b> JC	<i>Profile Status</i> <b>Jump Count Remain- ing</b> View the jump counts remaining for the cur- rent loop. In a profile with nested loops, this may not indicate the actual jump counts re- maining.	0 to 9,999	- - - -	<b>Instance 1</b> Map 1 Map 2 2538 4358	0x7A (122) 1 0xA (10)	- - - -	22010	uint R
No Dis- play	<i>Profile Status</i> <b>Profile State</b> Read current Profile state.	Off (62) Running (149) Pause (146)	- - - -	<b>Instance 1</b> Map 1 Map 2 2524 4344	0x7A (122) 1 2	- - - -	22002	uint R
No Dis- play	<i>Profile Status</i> <b>Current File</b> Indicates current file being executed.	1 to 25 0 (none)	- - - -	<b>Instance 1</b> Map 1 Map 2 2522 4342	0x7A (122) 1 3	- - - -	22003	uint R

\*\* R: Read, W: Write, E: EEPROM, S: User Set

# 6

## Chapter 6: Setup Page

### Navigating the Setup Page

To navigate to the Setup Page follow the steps below:

1. From the Home Page, press and hold both the Up ▲ and Down ▼ keys for six seconds. *A I* will appear in the upper display and *SEt* will appear in the lower display. If the up and down arrow keys are released where *oPEr* is displayed, simply press and hold those same keys for an additional 3 seconds.

**Note:** (for firmware release 13 and below)

If keys are released when *oPEr* is displayed, press the Infinity Key ∞ or reset key to exit and repeat until *SEt* is displayed.

2. Press the Up ▲ or Down ▼ key to view available menus.
3. Press the Advance Key ↻ to enter the menu of choice.
4. If a submenu exists (more than one instance), press the Up ▲ or Down ▼ key to select and then press the Advance Key ↻ to enter.
5. Press the Up ▲ or Down ▼ key to move through available menu prompts.
6. Press the Infinity Key ∞ to move backwards through the levels: parameter to submenu, submenu to menu, menu to Home Page.
7. Press and hold the Infinity Key ∞ for two seconds to return to the Home Page.

On the following pages, top level menus are identified with a yellow background color.

**Note:**

Some of these menus and parameters may not appear, depending on the controller's options. See model number information in the Appendix for more information. If there is only one instance of a menu, no submenus will appear.

**Note:**

Some of the listed parameters may not be visible. Parameter visibility is dependent upon controller part number.

<i>A I</i>		<i>P.E.L</i>	Process Error Low Value	<i>L n r</i>	
<i>SEt</i>	Analog Input Menu	<i>t.C</i>	Thermistor Curve	<i>SEt</i>	Linearization Menu
<i>SEn</i>	Sensor Type	<i>r.r</i>	Resistance Range	<i>F n</i>	Function
<i>L in</i>	TC Linearization	<i>F i L</i>	Filter	<i>SFnA</i>	Source Function A
<i>r t L</i>	RTD Leads	<i>i.Er</i>	Input Error Latching	<i>S i A</i>	Source Instance A
<i>Un it</i>	Units	<i>dEE</i>	Display Precision	<i>SZA</i>	Source Zone A
<i>SLo</i>	Scale Low	<i>i.CA</i>	Calibration Offset *	<i>Un it</i>	Units
<i>Sh i</i>	Scale High	<i>A in</i>	Analog Input Value *	<i>i.P.1</i>	Input Point 1
<i>r.Lo</i>	Range Low	<i>i.Er</i>	Input Error *	<i>o.P.1</i>	Output Point 1
<i>r.h i</i>	Range High			<i>i.P.2</i>	Input Point 2
<i>PEE</i>	Process Error Enable			<i>o.P.2</i>	Output Point 2
				<i>i.P.3</i>	Input Point 3

\*\* These parameters/prompts are available with firmware revisions 11.0 and above.



oP.3 Output Point 3  
 iP.4 Input Point 4  
 oP.4 Output Point 4  
 iP.5 Input Point 5  
 oP.5 Output Point 5  
 iP.6 Input Point 6  
 oP.6 Output Point 6  
 iP.7 Input Point 7  
 oP.7 Output Point 7  
 iP.8 Input Point 8  
 oP.8 Output Point 8  
 iP.9 Input Point 9  
 oP.9 Output Point 9  
 iP.10 Input Point 10  
 oP.10 Output Point 10

## PU

### SEE Process Value

F<sub>n</sub> Function  
 P<sub>unit</sub> Pressure Units  
 A<sub>unit</sub> Altitude Units  
 b<sub>Pr</sub> Barometric Pressure  
 F<sub>iL</sub> Filter

## d io

### SEE Digital Input/Output Menu

## S

d io Digital Input/Output (5 to 6)  
 d ir Direction  
 F<sub>n</sub> Function  
 F<sub>i</sub> Output Function Instance  
 a<sub>LT</sub> Time Base Type  
 a<sub>tb</sub> Fixed Time Base  
 a<sub>Lo</sub> Low Power Scale  
 a<sub>hi</sub> High Power Scale  
 LE<sub>v</sub> Active Level  
 F<sub>n</sub> Action Function  
 F<sub>i</sub> Function Instance

## Loop

### SEE Control Loop Menu

h<sub>AG</sub> Heat Algorithm  
 C<sub>AG</sub> Cool Algorithm  
 C<sub>Cr</sub> Cool Output Curve  
 h<sub>Pb</sub> Heat Proportional Band \*  
 h<sub>hY</sub> On/Off Heat Hysteresis \*  
 C<sub>Pb</sub> Cool Proportional Band \*  
 C<sub>hY</sub> On/Off Cool Hysteresis \*  
 t<sub>i</sub> Time Integral \*  
 t<sub>d</sub> Time Derivative \*  
 db Dead Band \*  
 t<sub>tUn</sub> TRU-TUNE+® Enable  
 t<sub>band</sub> TRU-TUNE+ Band  
 t<sub>gn</sub> TRU-TUNE+ Gain  
 A<sub>tSP</sub> Autotune Set Point \*  
 t<sub>AGr</sub> Autotune Aggressiveness  
 P<sub>dL</sub> Peltier Delay  
 U<sub>FA</sub> Auto-to-Manual Power  
 F<sub>A iL</sub> Input Error Power  
 P<sub>gAn</sub> Fixed Power  
 L<sub>dE</sub> Open Loop Detect Enable  
 L<sub>dE</sub> Open Loop Detect Time  
 L<sub>dd</sub> Open Loop Detect Deviation  
 r<sub>P</sub> Ramp Action  
 r<sub>SC</sub> Ramp Scale  
 r<sub>rt</sub> Ramp Rate  
 L<sub>SP</sub> Minimum Set Point  
 h<sub>SP</sub> Maximum Set Point  
 C<sub>SP</sub> Set Point\*  
 i<sub>dS</sub> Idle Set Point \*  
 S<sub>PLo</sub> Minimum Manual Power

S<sub>Ph</sub> Maximum Manual Power

o<sub>SP</sub> Manual Power \*

C<sub>PM</sub> Control Mode \*

## o t P t

### SEE Output Menu

## i

o<sub>tP t</sub> Output (1 to 2)  
 F<sub>n</sub> Function  
 a<sub>LT</sub> Time Base Type  
 a<sub>tb</sub> Fixed Time Base  
 a<sub>Lo</sub> Low Power Scale  
 a<sub>hi</sub> High Power Scale  
 o<sub>tP t</sub> Output Process 1  
 a<sub>tY</sub> Type  
 F<sub>n</sub> Function  
 r<sub>SR</sub> Retransmit Source  
 F<sub>i</sub> Output Function Instance  
 S<sub>Lo</sub> Scale Low  
 S<sub>hi</sub> Scale High  
 r<sub>Lo</sub> Range Low  
 r<sub>hi</sub> Range High  
 a<sub>CA</sub> Calibration Offset

## AL P t

### SEE Alarm Menu

## i

AL<sub>PM</sub> Alarm (1 to 4)  
 A<sub>tY</sub> Type  
 S<sub>rA</sub> Alarm Source  
 A<sub>hY</sub> Hysteresis  
 AL<sub>G</sub> Logic  
 AS<sub>d</sub> Sides  
 AL<sub>o</sub> Low Set Point \*  
 A<sub>hi</sub> High Set Point \*  
 AL<sub>A</sub> Latching  
 A<sub>bL</sub> Blocking  
 AS<sub>i</sub> Silencing  
 A<sub>dSP</sub> Display  
 A<sub>dL</sub> Delay Time  
 A<sub>CLr</sub> Clear Alarm \*

\* Available with PM4, PM8 and PM9 models only

\*\* These parameters/prompts are available with firmware revisions 11.0 and above.

*RS.ir* Silence Alarm \*

*RS.t* Alarm State \*

## *SP.r*

### *SE.t* Timer Menu

*t.en* Timer Enable

*t.st* Timer Start Method

*SFnA* Source Function A

*S.iA* Source Instance A

*SFnC* Source Function C

*S.iC* Source Instance C

*SFnD* Source Function D

*S.iD* Source Instance D

*t.r* Time Remaining

*r.bS* Ready Band State

*r.dY* Ready Band

*t.For* Time Format

*hOUr* Hours

*rn.in* Minutes

*SEC* Seconds

*CL.SP* Closed Loop Timer Set Point

*S.t* Signal Time

*C.LEd* Communications LED Action

*Zone* Zone

*ChAn* Channel

*dPrS* Display Pairs

*dt.i* Display Time

*USr.S* Save Settings As

*USr.r* Restore Settings From

## *CO.r*

### *SE.t* Communications Menu

*PCoL* Protocol

*AdS* Standard Bus Address

*Ad.r* Modbus Address

*bAUd* Baud Rate

*PAR* Parity

*rn.hL* Modbus Word Order

*C.F* Display Units

*rn.AP* Data Map

*nUS* Non-volatile Save

## *FUn*

### *SE.t* Function Menu

*i*

*FUn* Function Key (1 to 2)

*LEu* Active Level

*Fn* Action Function

*F.i* Function Instance

## *rtC*

### *SE.t* Real Time Clock

*hOUr* Hours

*rn.in* Minutes

*doWd* Day of Week

## *GLbL*

### *SE.t* Global Menu

*C.F* Display Units

*ACLF* AC Line Frequency

*rtYP* Ramping Type

*PtYP* Profile Type

*gSE* Guaranteed Soak Enable

*gSD1* Guaranteed Soak Deviation 1

*S.iA* Source Instance A

*S.iB* Source Instance B

*POt.i* Power Off Time

*SuTb* Synchronized Variable Time Base

## Setup Page

Display	Parameter Name Description	Range	Default	Modbus Relative Address	CIP - Class Instance Attribute hex (dec)	Pro-fibus Index	Parameter ID	Data Type and Access **
<b>A ,</b> <b>SEt</b> <b>Analog Input Menu</b>								
<b>SEn</b> SEn	<b>Analog Input Sensor Type</b> Set the analog sensor type to match the device wired to this input.  <b>Note:</b> There is no open sensor protection for process inputs.	<b>oFF</b> Off (62) <b>tC</b> Thermocouple (95) <b>mV</b> Millivolts (56) <b>volt</b> Volts dc (104) <b>mA</b> Milliamps dc (112) <b>rD.1H</b> RTD 100 Ω (113) <b>r10H</b> RTD 1,000 Ω (114) <b>Pot</b> Potentiometer 1 kΩ (155) <b>tHER</b> Thermistor (229)	Thermocouple or Thermistor	<b>Instance 1</b> Map 1 Map 2 368 368	0x68 (104) 1 5	3	4005	uint RWES
<b>Lin</b> Lin	<b>Analog Input TC Linearization</b> Set the linearization to match the thermocouple wired to this input.	<b>b</b> B (11) <b>H</b> K (48) <b>C</b> C (15) <b>n</b> N (58) <b>d</b> D (23) <b>r</b> R (80) <b>E</b> E (26) <b>S</b> S (84) <b>F</b> F (30) <b>t</b> T (93) <b>J</b> J (46)	J	<b>Instance 1</b> Map 1 Map 2 370 370	0x68 (104) 1 6	4	4006	uint RWES
<b>rt.L</b> rt.L	<b>Analog Input RTD Leads</b> Set to match the number of leads on the RTD wired to this input.	<b>2</b> 2 (1) <b>3</b> 3 (2)	2	<b>Instance 1</b> Map 1 Map 2 372 372	0x68 (104) 1 7	- - - -	4007	uint RWES
<b>Unit</b> Unit	<b>Analog Input Units</b> Set the type of units the sensor will measure.	<b>REp</b> Absolute Temperature (1540) <b>rh</b> Relative Humidity (1538) <b>Pro</b> Process (75) <b>PLUr</b> Power (73)	Process	<b>Instance 1</b> Map 1 Map 2 - - - - 442	0x68 (104) 1 0x2A (42)	5	4042	uint RWES

\* These parameters/prompts are available in these menus with firmware revisions 11.0 and above.

\*\* R: Read, W: Write, E: EEPROM, S: User Set

## Setup Page

Display	Parameter Name Description	Range	Default	Modbus Relative Ad- dress	CIP - Class Instance Attribute hex (dec)	Pro- fibus Index	Param- eter ID	Data Type and Access **
<b>SLo</b> S.Lo	<b>Analog Input Scale Low</b> Set the low scale for process inputs. This value, in millivolts, volts or milliamps, will correspond to the Range Low output of this function block.	-100.00 to 1,000.00	0.0	<b>Instance 1</b> Map 1 Map 2 388 388	0x68 (104) 1 0xF (15)	6	4015	float RWES
<b>SHi</b> S.hi	<b>Analog Input Scale High</b> Set the high scale for process inputs. This value, in millivolts, volts or milliampere, will correspond to the Range High output of this function block.	-100.00 to 1,000.00	20.0	<b>Instance 1</b> Map 1 Map 2 390 390	0x68 (104) 1 0x10 (16)	7	4016	float RWES
<b>rLo</b> r.Lo	<b>Analog Input Range Low</b> Set the low range for this function block's output.	-1,999.000 to 9,999.000	0.0	<b>Instance 1</b> Map 1 Map 2 392 392	0x68 (104) 1 0x11 (17)	8	4017	float RWES
<b>rHi</b> r.hi	<b>Analog Input Range High</b> Set the high range for this function block's output.	-1,999.000 to 9,999.000	9,999	<b>Instance 1</b> Map 1 Map 2 394 394	0x68 (104) 1 0x12 (18)	9	4018	float RWES
<b>P.EE</b> P.EE	<b>Analog Input Process Error En- able</b> Turn the Process Error Low feature on or off.	<b>oFF</b> Off (62) <b>LoLd</b> Low (53)	Off	<b>Instance 1</b> Map 1 Map 2 418 418	0x68 (104) 1 0x1E (30)	10	4030	uint RWES
<b>P.EL</b> P.EL	<b>Analog Input Process Error Low Value</b> If the process value drops below this value, it will trigger an input error.	-100.00 to 1,000.00	0.0	<b>Instance 1</b> Map 1 Map 2 420 420	0x68 (104) 1 0x1F (31)	11	4031	float RWES

\* These parameters/prompts are available in these menus with firmware revisions 11.0 and above.

\*\* R: Read, W: Write, E: EEPROM, S: User Set

## Setup Page

Display	Parameter Name Description	Range	Default	Modbus Relative Ad- dress	CIP - Class Instance Attribute hex (dec)	Pro- fibus Index	Param- eter ID	Data Type and Access **
t.C t.C	<i>Analog Input</i> <b>Thermistor Curve</b> Select a curve to ap- ply to the thermistor input.	<i>A</i> Curve A (1451) <i>b</i> Curve B (1452) <i>C</i> Curve C (1453) <i>CUSE</i> Custom (180)	Curve A	<i>Instance 1</i> Map 1 Map 2 434 434	0x68 (104) 1 0x26 (38)	- - - -	4038	uint RWES
r.r r.r	<i>Analog Input</i> <b>Resistance Range</b> Set the maximum resistance of the thermistor input.	<i>5</i> 5K (1448) <i>10</i> 10K (1360) <i>20</i> 20K (1361) <i>40</i> 40K (1449)	40K	<i>Instance 1</i> Map 1 Map 2 432 432	0x68 (104) 1 0x25 (37)	- - - -	4037	uint RWES
F.iL FiL	<i>Analog Input</i> <b>Filter</b> Filtering smooths out the process sig- nal to both the dis- play and the input. Increase the time to increase filtering.  <b>Note:</b> Filter does not ap- ply to the Limit sensor but does apply to all other functions.	0.0 to 60.0 seconds	0.5	<i>Instance 1</i> Map 1 Map 2 386 386	0x68 (104) 1 0xE (14)	12	4014	float RWES
i.Er i.Er	<i>Analog Input</i> <b>Input Error Latching</b> Turn input error latching on or off. If latching is on, errors must be manually cleared.	<i>oFF</i> Off (62) <i>oN</i> On (63)	Off	<i>Instance 1</i> Map 1 Map 2 414 414	0x68 (104) 1 0x1C (28)	- - - -	4028	uint RWES
dEC dEC	<i>Analog Input</i> <b>Display Precision</b> Set the precision of the displayed value.	<i>0</i> Whole (105) <i>00</i> Tenths (94) <i>000</i> Hundredths (40) <i>0000</i> Thousandths (96)	Whole	<i>Instance 1</i> Map 1 Map 2 398 398	0x68 (104) 1 0x14 (20)	- - - -	4020	uint RWES
i.CA i.CA	<i>Analog Input</i> <b>Calibration Offset *</b> Offset the input reading to compen- sate for lead wire resistance or other factors that cause the input reading to vary from the actual process value.	-1,999.000 to 9,999.000 °F or units -1,110.555 to 5,555.000 °C	0.0	<i>Instance 1</i> Map 1 Map 2 382 382	0x68 (104) 1 0xC (12)	2	4012	float RWES

\* These parameters/prompts are available in these menus with firmware revisions 11.0 and above.

\*\* R: Read, W: Write, E: EEPROM, S: User Set

## Setup Page

Display	Parameter Name Description	Range	Default	Modbus Relative Address	CIP - Class Instance Attribute hex (dec)	Pro-fibus Index	Parameter ID	Data Type and Access **
<i>Ain</i> Ain	<i>Analog Input</i> <b>Analog Input Value *</b> View the process value. Note: Ensure that the Error Status (below) indicates no error (61) when reading this value using a field bus protocol. If an error exists, the last known value prior to the error occurring will be returned.	-1,999.000 to 9,999.000°F or units -1,128.000 to 5,537.000°C	- - - -	<b>Instance 1</b> Map 1 Map 2 360 360	0x68 (104) 1 1	0	4001	float R
<i>i.Er</i> i.Er	<i>Analog Input</i> <b>Input Error *</b> View the cause of the most recent error.	<i>none</i> None (61) <i>OPEN</i> Open (65) <i>Short</i> Shorted (127) <i>EP7</i> Measurement Error (140) <i>E.CAL</i> Bad Calibration Data (139) <i>Er.Ab</i> Ambient Error (9) <i>Er.td</i> RTD Error (141) <i>FR.iL</i> Fail (32)	- - - -	<b>Instance 1</b> Map 1 Map 2 362 442	0x68 (104) 1 2	1	4002	uint R
<p><i>Lnr</i> <i>SEt</i> <b>Linearization Menu</b></p>								
<i>Fn</i> Fn	<i>Linearization</i> <b>Function</b> Set how this function will linearize Source A.	<i>oFF</i> Off (62) <i>intr</i> Interpolated (1482)	Off	<b>Instance 1</b> Map 1 Map 2 - - - - 3568	0x86 (134) 1 5	155	34005	uint RWES

\* These parameters/prompts are available in these menus with firmware revisions 11.0 and above.

\*\* R: Read, W: Write, E: EEPROM, S: User Set

## Setup Page

Display	Parameter Name Description	Range	Default	Modbus Relative Address	CIP - Class Instance Attribute hex (dec)	Pro-fibus Index	Parameter ID	Data Type and Access **
<i>Unit</i> Unit	<i>Linearization Units</i> Set the units of the output value.	<i>Src</i> Source (1539) <i>none</i> None (61) <i>ATP</i> Absolute Temperature (1540) <i>rATP</i> Relative Temperature (1541) <i>Pwr</i> Power (73) <i>Pro</i> Process (75) <i>rh</i> Relative Humidity (1538)	Source	<i>Instance 1</i> Map 1 Map 2 - - - - 3616	0x86 (134) 1 0x1D (29)	156	34029	uint RWES
<i>IP.1</i> ip.1	<i>Linearization Input Point 1</i> Set the value that will be mapped to output 1.	-1,999.000 to 9,999.000	0.0	<i>Instance 1</i> Map 1 Map 2 - - - - 3574	0x86 (134) 1 8	157	34008	float RWES
<i>OP.1</i> op.1	<i>Linearization Output Point 1</i> Set the value that will be mapped to input 1.	-1,999.000 to 9,999.000	0.0	<i>Instance 1</i> Map 1 Map 2 - - - - 3594	0x86 (134) 1 0x12 (18)	158	34018	float RWES
<i>IP.2</i> ip.2	<i>Linearization Input Point 2</i> Set the value that will be mapped to output 2.	-1,999.000 to 9,999.000	1.0	<i>Instance 1</i> Map 1 Map 2 - - - - 3576	0x86 (134) 1 9	159	34009	float RWES
<i>OP.2</i> op.2	<i>Linearization Output Point 2</i> Set the value that will be mapped to input 2.	-1,999.000 to 9,999.000	1.0	<i>Instance 1</i> Map 1 Map 2 - - - - 3596	0x86 (134) 1 0x13 (19)	160	34019	float RWES
<i>IP.3</i> ip.3	<i>Linearization Input Point 3</i> Set the value that will be mapped to output 3.	-1,999.000 to 9,999.000	2.0	<i>Instance 1</i> Map 1 Map 2 - - - - 3578	0x86 (134) 1 0xA (10)	161	34010	float RWES
<i>OP.3</i> op.3	<i>Linearization Output Point 3</i> Set the value that will be mapped to input 3.	-1,999.000 to 9,999.000	2.0	<i>Instance 1</i> Map 1 Map 2 - - - - 3598	0x86 (134) 1 0x14 (20)	162	34020	float RWES
<i>IP.4</i> ip.4	<i>Linearization Input Point 4</i> Set the value that will be mapped to output 4.	-1,999.000 to 9,999.000	3.0	<i>Instance 1</i> Map 1 Map 2 - - - - 3580	0x86 (134) 1 0xB (11)	163	34011	float RWES

\* These parameters/prompts are available in these menus with firmware revisions 11.0 and above.

\*\* R: Read, W: Write, E: EEPROM, S: User Set

## Setup Page

Display	Parameter Name Description	Range	Default	Modbus Relative Address	CIP - Class Instance Attribute hex (dec)	Pro-fibus Index	Parameter ID	Data Type and Access **
oP.4 op.4	<b>Linearization Output Point 4</b> Set the value that will be mapped to input 4.	-1,999.000 to 9,999.000	3.0	<b>Instance 1</b> Map 1 Map 2 - - - - 3600	0x86 (134) 1 0x15 (21)	164	34021	float RWES
iP.5 ip.5	<b>Linearization Input Point 5</b> Set the value that will be mapped to output 5.	-1,999.000 to 9,999.000	4.0	<b>Instance 1</b> Map 1 Map 2 - - - - 3582	0x86 (134) 1 0xC (12)	165	34012	float RWES
oP.5 op.5	<b>Linearization Output Point 5</b> Set the value that will be mapped to input 5.	-1,999.000 to 9,999.000	4.0	<b>Instance 1</b> Map 1 Map 2 - - - - 3602	0x86 (134) 1 0x16 (22)	166	34022	float RWES
iP.6 ip.6	<b>Linearization Input Point 6</b> Set the value that will be mapped to output 6.	-1,999.000 to 9,999.000	5.0	<b>Instance 1</b> Map 1 Map 2 - - - - 3584	0x86 (134) 1 0xD (13)	167	34013	float RWES
oP.6 op.6	<b>Linearization Output Point 6</b> Set the value that will be mapped to input 6.	-1,999.000 to 9,999.000	5.0	<b>Instance 1</b> Map 1 Map 2 - - - - 3604	0x86 (134) 1 0x17 (23)	168	34023	float RWES
iP.7 ip.7	<b>Linearization Input Point 7</b> Set the value that will be mapped to output 7.	-1,999.000 to 9,999.000	6.0	<b>Instance 1</b> Map 1 Map 2 - - - - 3586	0x86 (134) 1 E (14)	169	34014	float RWES
oP.7 op.7	<b>Linearization Output Point 7</b> Set the value that will be mapped to input 7.	-1,999.000 to 9,999.000	6.0	<b>Instance 1</b> Map 1 Map 2 - - - - 3606	0x86 (134) 1 0x18 (24)	170	34024	float RWES
iP.8 ip.8	<b>Linearization Input Point 8</b> Set the value that will be mapped to output 8.	-1,999.000 to 9,999.000	7.0	<b>Instance 1</b> Map 1 Map 2 - - - - 3588	0x86 (134) 1 0xF (15)	171	34015	float RWES
oP.8 op.8	<b>Linearization Output Point 8</b> Set the value that will be mapped to input 8.	-1,999.000 to 9,999.000	7.0	<b>Instance 1</b> Map 1 Map 2 - - - - 3608	0x86 (134) 1 0x19 (25)	172	34025	float RWES

\* These parameters/prompts are available in these menus with firmware revisions 11.0 and above.

\*\* R: Read, W: Write, E: EEPROM, S: User Set



## Setup Page

Display	Parameter Name Description	Range	Default	Modbus Relative Address	CIP - Class Instance Attribute hex (dec)	Pro-fibus Index	Parameter ID	Data Type and Access **
<b>IP.9</b> ip.9	<b>Linearization Input Point 9</b> Set the value that will be mapped to output 9.	-1,999.000 to 9,999.000	8.0	Instance 1 Map 1 Map 2 - - - - 3590	0x86 (134) 1 0x10 (16)	173	34016	float RWES
<b>OP.9</b> op.9	<b>Linearization Output Point 9</b> Set the value that will be mapped to input 9.	-1,999.000 to 9,999.000	8.0	<b>Instance 1</b> Map 1 Map 2 - - - - 3610	0x86 (134) 1 0x1A (26)	174	34026	float RWES
<b>IP.10</b> ip.10	<b>Linearization Input Point 10</b> Set the value that will be mapped to output 10.	-1,999.000 to 9,999.000	9.0	<b>Instance 1</b> Map 1 Map 2 - - - - 3592	0x86 (134) 1 0x11 (17)	175	34017	float RWES
<b>OP.10</b> op.10	<b>Linearization Output Point 10</b> Set the value that will be mapped to input 10.	-1,999.000 to 9,999.000	9.0	<b>Instance 1</b> Map 1 Map 2 - - - - 3612	0x86 (134) 1 0x1B (27)	176	34027	float RWES
<b>Pu</b> <b>SEt</b> <b>Process Value Menu</b>								
<b>Fn</b> Fn	<b>Process Value Function</b> Set the function that will be applied to the source or sources.	<b>OFF</b> Off (62) <b>ALT</b> Pressure to Altitude (1649)***	Off	<b>Instance 1</b> Map 1 Map 2 - - - - 3320	0x7E (126) 1 0x15 (21)	123	26021	uint RWES
<b>P.unt</b> P.unt	<b>Process Value Pressure Units***</b> If Process Value function is set for Pressure to Altitude units, define units of measure for conversion.	<b>PSI</b> Pounds per Square Inch (1671) <b>PaSc</b> Pascal (1674) <b>Atm</b> Atmosphere (1675) <b>Millibar</b> Millibar (1672) <b>Torr</b> Torr (1673)	PSI	<b>Instance 1</b> Map 1 Map 2 - - - - 3334	0x7E (126) 1 to 2 0x1C (28)	- - - -	26028	uint RWES
* These parameters/prompts are available in these menus with firmware revisions 11.0 and above.								
** R: Read, W: Write, E: EEPROM, S: User Set								

## Setup Page

Display	Parameter Name Description	Range	Default	Modbus Relative Address	CIP - Class Instance Attribute hex (dec)	Pro-fibus Index	Parameter ID	Data Type and Access **
<i>A.unt</i> A.unt	<i>Process Value</i> <b>Altitude Units***</b> If Process Value function is set for Pressure to Altitude units, define units of measure for conversion.	<i>Hft</i> Kilofeet (1677) <i>Ft</i> Feet (1676)	Hft	<b>Instance 1</b> Map 1 Map 2 - - - - 3336	0x7E (126) 1 0x1D (29)	- - - -	26029	uint RWES
<i>b.Pr</i> b.Pr	<i>Process Value</i> <b>Barometric Pressure***</b> If Process Value function is set for Wet Bulb / Dry Bulb, define pressure value used for humidity calculation.	10.0 to 16.0	14.7	<b>Instance 1</b> Map 1 Map 2 - - - - 3338	0x7E (126) 1 0x1E (30)	- - - -	26030	float RWES
<i>Fil</i> FiL	<i>Process Value</i> <b>Filter</b> Filtering smooths out the output signal of this function block. Increase the time to increase filtering.	0.0 to 60.0 seconds	0.0	<b>Instance 1</b> Map 1 Map 2 - - - - 3330	0x7E (126) 1 0x1A (26)	- - - -	26026	float RWES

\*\*\* Pressure Altitude calculation is based on the International Standard Atmosphere 1976

*d io*  
*SEt*

### Digital Input/Output Menu

<i>dir</i> dir	<i>Digital Input/Output</i> (5 to 6) <b>Direction</b> Set this function to operate as an input or output.	<i>oPt</i> Output (68) <i>iCon</i> Input Dry Contact (44) <i>iV</i> Input Voltage (193)	Output	<b>Instance 5</b> Map 1 Map 2 1000 1120  Offset to next instance (Map 1 & Map 2) equals +30	0x6A (106) 5 to 6 1	82	6001	uint RWES
-------------------	--	---	--------	---	---------------------------	----	------	--------------

\* These parameters/prompts are available in these menus with firmware revisions 11.0 and above.

\*\* R: Read, W: Write, E: EEPROM, S: User Set

## Setup Page

Display	Parameter Name Description	Range	Default	Modbus Relative Address	CIP - Class Instance Attribute hex (dec)	Pro-fibus Index	Parameter ID	Data Type and Access **
<i>F<sub>n</sub></i> Fn	<i>Digital Output (5 to 6)</i> <b>Function</b> Select what function will drive this output.	<i>oFF</i> Off (62) <i>ALrA</i> Alarm (6) <i>HEAt</i> Heat (36) <i>COOL</i> Cool (20) <i>tE.o1</i> Timer Event Output 1 (1951) <i>tE.o2</i> Timer Event Output 2 (1952) <i>tE.o3</i> Timer Event Output 3 (1953) <i>EntA</i> Profile Event Out A (233) <i>EntB</i> Profile Event Out B (234) <i>HEr</i> Heater Error (184)	Off	<b>Instance 5</b> Map 1 Map 2 1008 1128  Offset to next instance (Map 1 & Map 2) equals +30	0x 6A (106) 5 to 6 5	83	6005	uint RWES
<i>F<sub>i</sub></i> Fi	<i>Digital Output (5 to 6)</i> <b>Output Function Instance</b> Set the instance of the function selected above.	1 to 4	1	<b>Instance 5</b> Map 1 Map 2 1010 1130  Offset to next instance (Map 1 & Map 2) equals +30	0x6A (106) 5 to 6 6	84	6006	uint RWES
<i>o.Ct</i> o.Ct	<i>Digital Output (5 to 6)</i> <b>Time Base Type</b> Set the time base type. This parameter is only used with PID control, but can be set any-time.	<i>FtB</i> Fixed Time Base (34) <i>vTb</i> Variable Time Base (103)	Fixed Time Base	<b>Instance 5</b> Map 1 Map 2 1002 1122  Offset to next instance (Map 1 & Map 2) equals +30	0x6A (106) 5 to 6 2	85	6002	uint RWES
<i>o.tb</i> o.tb	<i>Digital Output (5 to 6)</i> <b>Fixed Time Base</b> Set the time base for fixed-time-base control.  <b>Note:</b> Modbus Map 1 has instances 5 through 8 only	0.1 to 60.0 seconds	1.0	<b>Instance 5</b> Map 1 Map 2 1004 1124  Offset to next instance (Map 1 & Map 2) equals +30	0x6A (106) 5 to 6 3	86	6003	float RWES

\* These parameters/prompts are available in these menus with firmware revisions 11.0 and above.

\*\* R: Read, W: Write, E: EEPROM, S: User Set

## Setup Page

Display	Parameter Name Description	Range	Default	Modbus Relative Address	CIP - Class Instance Attribute hex (dec)	Pro-fibus Index	Parameter ID	Data Type and Access **
o.Lo o.Lo	<b>Digital Output (5 to 6)</b> <b>Low Power Scale</b> The power output will never be less than the value specified and will represent the value at which output scaling begins.	0.0 to 100.0%	0.0	<b>Instance 5</b> Map 1 Map 2 1016 1136  Offset to next instance (Map 1 & Map 2) equals +30	0x6A (106) 5 to 6 9	87	6009	float RWES
o.hi o.hi	<b>Digital Output (5 to 6)</b> <b>High Power Scale</b> The power output will never be greater than the value specified and will represent the value at which output scaling stops.	0.0 to 100.0%	100.0	<b>Instance 5</b> Map 1 Map 2 1018 1138  Offset to next instance (Map 1 & Map 2) equals +30	0x6A (106) 5 to 6 A (10)	88	6010	float RWES
LEv LEv	<b>Digital Input (5 to 6)</b> <b>Active Level</b> Select which action will be interpreted as a true state.	h.igh High (37) Low (53)	High	<b>Instance 5</b> Map 1 Map 2 1320 1560  Offset to next instance (Map 1 & Map 2) equals +20	0x6E (110) 5 to 6 1	137	10001	uint RW
LEv LEv	<b>Digital Input (7 to 12)</b> <b>Active Level</b> Select which action will be interpreted as a true state.  <b>Note:</b> Modbus Map 1 has instances 7 and 8 only	h.igh High (37) Low (53)	High	<b>Instance 7</b> Map 1 Map 2 1400 1640  Offset to next instance Map 2 equals +20	0x6E (110) 7 to C (12) 1	137	10001	uint RW

\* These parameters/prompts are available in these menus with firmware revisions 11.0 and above.

\*\* R: Read, W: Write, E: EEPROM, S: User Set

## Setup Page

Display	Parameter Name Description	Range	Default	Modbus Relative Address	CIP - Class Instance Attribute hex (dec)	Pro-fibus Index	Parameter ID	Data Type and Access **
<i>F<sub>n</sub></i> Fn	<i>Digital Input (5 to 6)</i> <b>Action Function</b> Select the function that will be triggered by a true state for Digital Inputs 5 to 6.	<i>none</i> None (61) <i>STP</i> Start Step (1077) <i>PST</i> Profile Start/ Stop, level triggered (208) <i>PrOF</i> Start Profile, edge triggered (196) <i>P.hoL</i> Profile Hold/ Resume, level triggered (207) <i>P.d .S</i> Profile Disable, level triggered (206) <i>t.dR</i> TRU-TUNE+® Disable, level triggered (219) <i>oFF</i> Switch Control Loop Off, level triggered (90) <i>MAN</i> Manual, level triggered (54) <i>tUnE</i> Tune, edge triggered (98) <i>idLE</i> Idle Set Point, level triggered (107) <i>F.AL</i> Force Alarm to occur, level triggered (218) <i>RoF</i> Control Loops Off and Alarms to Non-alarm State, level triggered (220) <i>S .L</i> Silence Alarms, edge triggered (108) <i>ALRN</i> Alarm Reset, edge triggered (6) <i>P.LoC</i> Keypad Lock-out, level triggered (217) <i>uS.r.r</i> User Set Restore, edge triggered (227)	None	<i>Instance 5</i> Map 1    Map 2 1324    1564  Offset to next instance (Map 1 & Map 2) equals +20	0x6E (110) 5 to 6 3	138	10003	uint RWES

\* These parameters/prompts are available in these menus with firmware revisions 11.0 and above.

\*\* R: Read, W: Write, E: EEPROM, S: User Set

## Setup Page

Display	Parameter Name Description	Range	Default	Modbus Relative Address	CIP - Class Instance Attribute hex (dec)	Pro-fibus Index	Parameter ID	Data Type and Access **
<b>F</b> Fi	<b>Digital Input (5 to 6) Function Instance</b> Select which Digital Input will be triggered by a true state.	0 to 40	0	<b>Instance 5</b> Map 1 1326    Map 2 1566  Offset to next instance (Map 1 & Map 2) equals +20	0x6E (110) 5 to 6 4	139	10004	uint RWES

### Loop SET

#### Control Loop Menu

<b>hAg</b> h.Ag	<b>Control Loop Heat Algorithm</b> Set the heat control method.	<b>oFF</b> Off (62) <b>P id</b> PID (71) <b>o.n.oF</b> On-Off (64)	PID	<b>Instance 1</b> Map 1 1884    Map 2 2364	0x97 (151) 1 3	72	8003	uint RWES
<b>CAG</b> C.Ag	<b>Control Loop Cool Algorithm</b> Set the cool control method.	<b>oFF</b> Off (62) <b>P id</b> PID (71) <b>o.n.oF</b> On-Off (64)	Off	<b>Instance 1</b> Map 1 1886    Map 2 2366	0x97 (151) 1 4	73	8004	uint RWES
<b>CCr</b> C.Cr	<b>Control Loop Cool Output Curve</b> Select a cool output curve to change the responsiveness of the system.	<b>oFF</b> Off (62) <b>Cr.A</b> Non-linear Curve 1 (214) <b>Cr.b</b> Non-linear Curve 2 (215)	Off	<b>Instance 1</b> Map 1 1888    Map 2 2368	0x97 (151) 1 5	- - - -	8038	uint RWES
<b>hPb</b> h.Pb	<b>Control Loop Heat Proportional Band *</b> Set the PID proportional band for the heat outputs.	0.001 to 9,999.000 °F or units 0.001 to 5,555.000 °C	25.0 °F or units 14.0 °C	<b>Instance 1</b> Map 1 1890    Map 2 2370	0x97 (151) 1 6	65	8009	float RWES
<b>hHy</b> h.hy	<b>Control Loop On / Off Heat Hysteresis *</b> Set the control switching hysteresis for on-off control. This determines how far into the "on" region the process value needs to move before the output turns on.	0.001 to 9,999.000 °F or units 0.001 to 5,555.000 °C	3.0 °F or units 2.0 °C	<b>Instance 1</b> Map 1 1900    Map 2 2380	0x97 (151) 1 0xB (11)	66	8010	float RWES

\* These parameters/prompts are available in these menus with firmware revisions 11.0 and above.

\*\* R: Read, W: Write, E: EEPROM, S: User Set

## Setup Page

Display	Parameter Name Description	Range	Default	Modbus Relative Address	CIP - Class Instance Attribute hex (dec)	Pro-fibus Index	Parameter ID	Data Type and Access **
<b>C.Pb</b> C.Pb	<b>Control Loop Cool Proportional Band *</b> Set the PID proportional band for the cool outputs.	0.001 to 9,999.000 °F or units 0.001 to 5,555.000 °C	25.0 °F or units 14.0 °C	<b>Instance 1</b> Map 1 Map 2 1892 2372	0x97 (151) 1 7	67	8012	float RWES
<b>C.hy</b> C.hy	<b>Control Loop On/Off Cool Hysteresis *</b> Set the control switching hysteresis for on-off control. This determines how far into the "on" region the process value needs to move before the output turns on.	0.001 to 9,999.000 °F or units 0.001 to 5,555.000 °C	3.0 °F or units 2.0 °C	<b>Instance 1</b> Map 1 Map 2 1902 2382	0x97 (151) 1 0xC (12)	68	8013	float RWES
<b>ti</b>	<b>Control Loop Time Integral *</b> Set the PID integral for the outputs.	0 to 9,999 seconds per repeat	180 seconds per repeat	<b>Instance 1</b> Map 1 Map 2 1894 2374	0x97 (151) 1 8	69	8006	float RWES
<b>td</b>	<b>Control Loop Time Derivative *</b> Set the PID derivative time for the outputs.	0 to 9,999 seconds	0 seconds	<b>Instance 1</b> Map 1 Map 2 1896 2376	0x97 (151) 1 9	70	8007	float RWES
<b>db</b>	<b>Control Loop (1 to 2) Dead Band *</b> Set the offset to the proportional band. With a negative value, both heating and cooling outputs are active when the process value is near the set point. A positive value keeps heating and cooling outputs from fighting each other.	-1,000.0 to 1,000.0 °F or units -556 to 556 °C	0.0	<b>Instance 1</b> Map 1 Map 2 1898 2378  <b>Instance 2</b> Map 1 Map 2 1968 2448	0x97 (151) 1 to 2 0xA (10)	71	8008	float RWES

\* These parameters/prompts are available in these menus with firmware revisions 11.0 and above.

\*\* R: Read, W: Write, E: EEPROM, S: User Set

## Setup Page

Display	Parameter Name Description	Range	Default	Modbus Relative Address	CIP - Class Instance Attribute hex (dec)	Pro-fibus Index	Parameter ID	Data Type and Access **
<i>t.tUn</i>	<b>Control Loop TRU-TUNE+® Enable</b> Enable or disable the TRU-TUNE+ adaptive tuning feature.	<i>no</i> No (59) <i>YES</i> Yes (106)	No	<b>Instance 1</b> Map 1 1910    Map 2 2390	0x97 (151) 1 10 (16)	- - - -	8022	uint RWES
<i>t.bnd</i>	<b>Control Loop TRU-TUNE+ Band</b> Set the range, centered on the set point, within which TRU-TUNE+ will be in effect. Use this function only if the controller is unable to adaptive tune automatically.	0 to 100	0	<b>Instance 1</b> Map 1 1912    Map 2 2392	0x97 (151) 1 0x11 (17)	- - - -	8034	uint RWES
<i>t.gn</i>	<b>Control Loop TRU-TUNE+ Gain</b> Select the responsiveness of the TRU-TUNE+ adaptive tuning calculations. More responsiveness may increase overshoot.	1 to 6	3	<b>Instance 1</b> Map 1 1914    Map 2 2394	0x97 (151) 1 0x12 (18)	- - - -	8035	uint RWES
<i>A.tSP</i>	<b>Control Loop Autotune Set Point *</b> Set the set point that the autotune will use, as a percentage of the current set point.	50 to 200%	90.0	<b>Instance 1</b> Map 1 1918    Map 2 2398	0x97 (151) 1 0x14 (20)	- - - -	8025	float RWES
<i>t.Agr</i>	<b>Control Loop Autotune Aggressiveness</b> Select the aggressiveness of the autotuning calculations.	<i>Undr</i> Under damped (99) <i>Crit</i> Critical damped (21) <i>ouEr</i> Over damped (69)	Critical	<b>Instance 1</b> Map 1 1916    Map 2 2396	0x97 (151) 1 0x13 (19)	- - - -	8024	uint RWES

\* These parameters/prompts are available in these menus with firmware revisions 11.0 and above.

\*\* R: Read, W: Write, E: EEPROM, S: User Set



## Setup Page

Display	Parameter Name Description	Range	Default	Modbus Relative Address	CIP - Class Instance Attribute hex (dec)	Pro-fibus Index	Parameter ID	Data Type and Access **
<i>P.dL</i> P.dL	<b>Control Loop Peltier Delay</b> Set a value that will cause a delay when switching from heat PID mode to cool PID mode.	0.0 to 5.0 seconds	0.0	<b>Instance 1</b> Map 1    Map 2 1934    2414	0x97 (151) 1 0x1C (28)	- - - -	8051	float RWES
<i>UFA</i> UFA	<b>Control Loop Auto-to-Manual Power</b> Select what the controller outputs will do when the user switches control to manual mode.	<b>oFF</b> Off, sets output power to 0% (62) <b>bPLS</b> Bumpless transfer, maintains same output power, if it was less than 75% and stable, otherwise 0% (14) <b>FFAn</b> Fixed Power, sets output power to Fixed Power setting (54) <b>USEr</b> User, sets output power to last open-loop set point the user entered (100)	User	<b>Instance 1</b> Map 1    Map 2 2182    2662	0x6B (107) 1 0xC (12)	- - - -	7012	uint RWES
<i>FAiL</i> FAiL	<b>Control Loop Input Error Power</b> Select what the controller outputs will do when an input error switches control to manual mode.	<b>oFF</b> Off, sets output power to 0% (62) <b>bPLS</b> Bumpless transfer, maintains same output power, if it was less than 75% and stable, otherwise 0% (14) <b>FFAn</b> Fixed Power, sets output power to Fixed Power setting (54) <b>USEr</b> User, sets output power to last open-loop set point the user entered (100)	User	<b>Instance 1</b> Map 1    Map 2 2184    2664	0x6B (107) 1 0xD (13)	- - - -	7013	uint RWES

\* These parameters/prompts are available in these menus with firmware revisions 11.0 and above.

\*\* R: Read, W: Write, E: EEPROM, S: User Set

## Setup Page

Display	Parameter Name Description	Range	Default	Modbus Relative Ad- dress	CIP - Class Instance Attribute hex (dec)	Pro- fibus Index	Param- eter ID	Data Type and Access **
<b>MAAn</b> MAAn	<b>Control Loop Fixed Power</b> Set the manual output power level that will take effect if an input error failure occurs while User Failure Action is set to Fixed Power.	Set Point Open Loop Limit Low to Set Point Open Loop Limit High (Setup Page)	0.0	<b>Instance 1</b> Map 1    Map 2 2180    2660	0x6B (107) 1 0xB (11)	- - - -	7011	float RWES
<b>LdE</b> L.dE	<b>Control Loop Open Loop Detect Enable</b> Select Yes to detect conditions that prevent the process from changing in specified time frame by a specified amount when PID power is at 100%. An open loop detect error will disable the control loop.	<b>no</b> No (59) <b>YES</b> Yes (106)	No	<b>Instance 1</b> Map 1    Map 2 1922    2402	0x97 (151) 1 0x16 (22)	74	8039	uint RWES
No Display	<b>Control Loop Open Loop Error Status</b> View the cause of the most recent error.	none (61) Open Loop (1274) Reversed Sensor (1275)	- - - -	<b>Instance 1</b> Map 1    Map 2 1928    2408	0x97 (151) 1 0x19 (25)	- - - -	8048	uint R
<b>Ldt</b> L.dt	<b>Control Loop Open Loop Detect Time</b> Process must deviate by the Open Loop Detect Deviation value in the specified time, while at 100% PID power, otherwise an Open Loop Detect event is triggered.	0 to 3,600 seconds	240	<b>Instance 1</b> Map 1    Map 2 1924    2404	0x97 (151) 1 0x17 (23)	75	8040	uint RWES

\* These parameters/prompts are available in these menus with firmware revisions 11.0 and above.

\*\* R: Read, W: Write, E: EEPROM, S: User Set

## Setup Page

Display	Parameter Name Description	Range	Default	Modbus Relative Address	CIP - Class Instance Attribute hex (dec)	Pro-fibus Index	Parameter ID	Data Type and Access **
L.dd L.dd	<b>Control Loop Open Loop Detect Deviation</b> Process must deviate by this value in the Open Loop Detect Time while at 100% PID power to prevent an open loop error.	-1,999.000 to 9,999.000 °F or units -1,110.555 to 5,555.000 °C	10.0 °F or units 6.0 °C	<b>Instance 1</b> Map 1 Map 2 1926 2406	0x97 (151) 1 0x18 (24)	76	8041	float RWES
r.P r.P	<b>Control Loop Ramp Action</b> Select when the controller's set point will ramp to the defined end set point.	<b>oFF</b> Off (62) <b>StAr</b> Startup (88) <b>SEtP</b> Set Point Change (85) <b>boTh</b> Both (13)	Off	<b>Instance 1</b> Map 1 Map 2 2186 2666	0x6B (107) 1 0xE (14)	56	7014	uint RWES
r.SC r.SC	<b>Control Loop Ramp Scale</b> Select the scale of the ramp rate.	<b>hOUr</b> Hours (39) <b>Min</b> Minutes (57)	Minutes	<b>Instance 1</b> Map 1 Map 2 2188 2668	0x6B (107) 1 0xF (15)	57	7015	uint RWES
r.r.t r.r.t	<b>Control Loop Ramp Rate</b> Set the rate for the set point ramp. Set the time units for the rate with the Ramp Scale parameter.	0.0 to 9,999.000 °F or units 0.0 to 5,555.000 °C	1.0 °F or units 1.0 °C	<b>Instance 1</b> Map 1 Map 2 2192 2672	0x6B (107) 1 0x11 (17)	58	7017	float RWES
L.SP L.SP	<b>Control Loop Minimum Set Point</b> Set the minimum value of the closed loop set point range.	-1,999.000 to 9,999.000 °F or units -1,128.000 to 5,537.000 °C	-1,999 °F or units -1,128 °C	<b>Instance 1</b> Map 1 Map 2 2164 2644 <b>Instance 2</b> Map 1 Map 2 2244 2724	0x6B (107) 1 3	52	7003	float RWES
h.SP h.SP	<b>Control Loop Maximum Set Point</b> Set the maximum value of the closed loop set point range.	-1,999.000 to 9,999.000 °F or units -1,128.000 to 5,537.000 °C	9,999 °F or units 5,537 °C	<b>Instance 1</b> Map 1 Map 2 2166 2646	0x6B (107) 1 4	53	7004	float RWES
C.SP C.SP	<b>Control Loop Set Point *</b> Set the set point that the controller will automatically control to.	-1,999.000 to 9,999.000 °F or units -1,128.000 to 5,537.000 °C	75.0 °F or units 24.0 °C	<b>Instance 1</b> Map 1 Map 2 2160 2640	0x6B (107) 1 1	49	7001	float RWES

\* These parameters/prompts are available in these menus with firmware revisions 11.0 and above.  
 \*\* R: Read, W: Write, E: EEPROM, S: User Set

## Setup Page

Display	Parameter Name Description	Range	Default	Modbus Relative Address	CIP - Class Instance Attribute hex (dec)	Pro-fibus Index	Parameter ID	Data Type and Access **
<b>id.S</b> id.S	<b>Control Loop Idle Set Point *</b> Set a closed loop set point that can be triggered by an event state.	-1,999.000 to 9,999.000 °F or units -1,128.000 to 5,537.000 °C	75.0 °F or units 24.0 °C	<b>Instance 1</b> Map 1 Map 2 2176 2656	0x6B (107) 1 9	50	7009	float RWES
<b>SP.Lo</b> SP.Lo	<b>Control Loop Minimum Manual Power</b> Set the minimum value of the open-loop set point range.	-100.0 to 100.0%	-100	<b>Instance 1</b> Map 1 Map 2 2168 2648	0x6B (107) 1 5	54	7005	float RWES
<b>SP.hi</b> SP.hi	<b>Control Loop Maximum Manual Power</b> Set the maximum value of the open-loop set point range.	-100.0 to 100.0%	100	<b>Instance 1</b> Map 1 Map 2 2170 2650	0x6B (107) 1 6	55	7006	float RWES
<b>o.SP</b> o.SP	<b>Control Loop Manual Power *</b> Set a fixed level of output power when in manual (open-loop) mode.	-100.0 to 100.0% (heat and cool) 0 to 100.0% (heat only) -100.0 to 0% (cool only)	0.0	<b>Instance 1</b> Map 1 Map 2 2162 2642	0x6B (107) 1 2	51	7002	float RWES
<b>C.M</b> C.M	<b>Control Loop Control Mode *</b> Select the method that this loop will use to control.	<b>oFF</b> Off (62) <b>Auto</b> Auto (10) <b>MAN</b> Manual (54)	Auto	<b>Instance 1</b> Map 1 Map 2 1880 2360	0x97 (151) 1 1	63	8001	uint RWES

\* These parameters/prompts are available in these menus with firmware revisions 11.0 and above.

\*\* R: Read, W: Write, E: EEPROM, S: User Set

## Setup Page

Display	Parameter Name Description	Range	Default	Modbus Relative Address	CIP - Class Instance Attribute hex (dec)	Pro-fibus Index	Parameter ID	Data Type and Access **
<b>o t P t</b> <b>5 E t</b> <b>Output Menu</b>								
<b>F n</b> Fn	Output Digital (1 to 2) <b>Function</b> Select what function will drive this output.	<b>o F F</b> Off (62) <b>A L P t</b> Alarm (6) <b>h E A t</b> Heat (36) <b>C o o l</b> Cool (20) <b>t E . o 1</b> Timer Event 1 (1951) <b>t E . o 2</b> Timer Event 2 (1952) <b>t E . o 3</b> Timer Event 3 (1953) <b>E n t . A</b> Profile Event Out A (233) <b>E n t . b</b> Profile Event Out B (234) <b>h E r</b> Heater Error (184)	Output 1 - Heat Output 2 - Alarm	<b>Instance 1</b> Map 1    Map 2 888    1008	0x6A (106) 1 to 2 5	83	6005	uint RWES
<b>F i</b> Fi	Output Digital (1 to 2) <b>Output Function Instance</b> Set the instance of the function selected above.	1 to 4	1	<b>Instance 1</b> Map 1    Map 2 890    1010	0x6A (106) 1 to 2 6	84	6006	uint RWES
<b>o . t t</b> o.Ct	Output Digital (1 to 2) <b>Time Base Type</b> Set the time base type. This parameter is only used with PID control, but can be set anytime.	<b>F t b</b> Fixed Time Base (34) <b>v t b</b> Variable Time Base (103)	Fixed Time Base	<b>Instance 1</b> Map 1    Map 2 882    1002	0x6A (106) 1 to 2 2	85	6002	uint RWES
<b>o . t b</b> o.tb	Output Digital (1 to 2) <b>Fixed Time Base</b> Set the time base for fixed-time-base control.	0.1 to 60.0 seconds (solid-state relay or switched dc) 5.0 to 60.0 seconds (mechanical relay or NO-ARC power control)	1.0 sec. for SSR or swdc 5.0 for relay	<b>Instance 1</b> Map 1    Map 2 884    1004	0x6A (106) 1 to 2 3	86	6003	float RWES

\* These parameters/prompts are available in these menus with firmware revisions 11.0 and above.  
 \*\* R: Read, W: Write, E: EEPROM, S: User Set

## Setup Page

Display	Parameter Name Description	Range	Default	Modbus Relative Address	CIP - Class Instance Attribute hex (dec)	Pro-fibus Index	Parameter ID	Data Type and Access **
o.Lo o.Lo	<i>Output Digital (1 to 2)</i> <b>Low Power Scale</b> The power output will never be less than the value specified and will represent the value at which output scaling begins.	0.0 to 100.0%	0.0%	<b>Instance 1</b> Map 1 Map 2 896 1016  Offset to next instance (Map 1 & Map 2) equals +30	0x6A (106) 1 to 2 9	87	6009	float RWES
o.hi o.hi	<i>Output Digital (1 to 2)</i> <b>High Power Scale</b> The power output will never be greater than the value specified and will represent the value at which output scaling stops.	0.0 to 100.0%	100.0%	<b>Instance 1</b> Map 1 Map 2 898 1018  Offset to next instance (Map 1 & Map 2) equals +30	0x6A (106) 1 to 2 0x0A (10)	88	6010	float RWES
o.ty o.ty	<i>Output Process (1)</i> <b>Type</b> Select whether the process output will operate in volts or milliamps.	vOLt Volts (104) mA Milliamps (112)	Volts	<b>Instance 1</b> Map 1 Map 2 720 840	0x76 (118) 1 1	95	18001	uint RWES
Fn Fn	<i>Output Process (1)</i> <b>Function</b> Set the type of function that will drive this output.	oFF Off (62) HEAt Heat (36) COOL Cool (20) dUPL Duplex (212) ALArM Alarm (6) Ent.A Profile Event Out A (233) Ent.B Profile Event Out B (234) rPt Retransmit (213)	Off	<b>Instance 1</b> Map 1 Map 2 722 842	0x76 (118) 1 2	96	18002	uint RWES
r.Sr r.Sr	<i>Output Process (1)</i> <b>Retransmit Source</b> Select the value that will be retransmitted.	A Analog Input (142) SEtPt Set Point (85) CUrr Current Sample and hold (22) P Process Value (241)	Analog Input	<b>Instance 1</b> Map 1 Map 2 724 844	0x76 (118) 1 3	97	18003	uint RWES

\* These parameters/prompts are available in these menus with firmware revisions 11.0 and above.

\*\* R: Read, W: Write, E: EEPROM, S: User Set

## Setup Page

Display	Parameter Name Description	Range	Default	Modbus Relative Ad- dress	CIP - Class Instance Attribute hex (dec)	Pro- fibus Index	Param- eter ID	Data Type and Access **
<b>F<sub>i</sub></b> Fi	<b>Output Process (1) Function Instance</b> Set the instance of the function select- ed above.	1 to 4	1	<b>Instance 1</b> Map 1 Map 2 726 846	0x76 (118) 1 4	98	18004	uint RWES
<b>S<sub>Lo</sub></b> S.Lo	<b>Output Process (1) Scale Low</b> Set the scale low for process output in electrical units. This value; in volts or milliamps, will correspond to 0% PID power output or range low retrans- mit output.	-100.0 to 100.0	0.00	<b>Instance 1</b> Map 1 Map 2 736 856	0x76 (118) 1 9	99	18009	float RWES
<b>S<sub>hi</sub></b> S.hi	<b>Output Process (1) Scale High</b> Set the scale high for process output in electrical units. This value; in volts or milliamps, will cor- respond to 100% PID power output or range high retrans- mit output.	-100.0 to 100.0	10.00	<b>Instance 1</b> Map 1 Map 2 738 858	0x76 (118) 1 0x0A (10)	100	18010	float RWES
<b>r<sub>Lo</sub></b> r.Lo	<b>Output Process (1) Range Low</b> Set the minimum value of the re- transmit value range in process units. When the retransmit source is at this value, the retransmit output will be at its Scale Low value.	-1,999.000 to 9,999.000 °F or units -1,128.000 to 5,537.000 °C	0.0 °F or units -18 °C	<b>Instance 1</b> Map 1 Map 2 740 860	0x76 (118) 1 0xB (11)	101	18011	float RWES

\* These parameters/prompts are available in these menus with firmware revisions 11.0 and above.

\*\* R: Read, W: Write, E: EEPROM, S: User Set

## Setup Page

Display	Parameter Name Description	Range	Default	Modbus Relative Address	CIP - Class Instance Attribute hex (dec)	Pro-fibus Index	Parameter ID	Data Type and Access **
r.h i r.hi	<b>Output Process (1) Range High</b> Set the maximum value of the retransmit value range in process units. When the retransmit source is at this value, the retransmit output will be at its Scale High value.	-1,999.000 to 9,999.000°F or units -1,128.000 to 5,537.000°C	100.0°F or units 38.0°C	<b>Instance 1</b> Map 1 Map 2 742 862	0x76 (118) 1 0x0C (12)	102	18012	float RWES
o.CA o.CA	<b>Output Process (1) Calibration Offset</b> Set an offset value for a process output.	-1,999.000 to 9,999.000°F or units -1,110.555 to 5,555.000°C	0.0°F or units 0.0°C	<b>Instance 1</b> Map 1 Map 2 732 852	0x76 (118) 1 7	105	18007	float RWES

**ALP7**

**SET**

### Alarm Menu

ALY A.ty	<b>Alarm (1 to 4) Type</b> Select whether the alarm trigger is a fixed value or will track the set point.	oFF Off (62) Pr.AL Process Alarm (76) dE.AL Deviation Alarm (24)	Off	<b>Instance 1</b> Map 1 Map 2 1508 1908  Offset to next instance (Map 1 +50, Map 2 +60)	0x6D (109) 1 to 4 0xF (15)	20	9015	uint RWES
Sr.A Sr.A	<b>Alarm (1 to 4) Alarm Source</b> Select what will trigger this alarm.	nonE None (61) A i Analog Input (142) Lnr Linearization (238) Pu Process Value (241) PuJr Power (73) LdCu Load Current RMS (179) CUrr Current Read is Sample and Hold (22)		<b>Instance 1</b> Map 1 Map 2 1512 1912  Offset to next instance (Map 1 +50, Map 2 +60)	0x6D (109) 1 to 4 0x11 (17)	21	9017	uint RWES

\* These parameters/prompts are available in these menus with firmware revisions 11.0 and above.

\*\* R: Read, W: Write, E: EEPROM, S: User Set



## Setup Page

Display	Parameter Name Description	Range	Default	Modbus Relative Address	CIP - Class Instance Attribute hex (dec)	Pro-fibus Index	Parameter ID	Data Type and Access **
<b>A.hy</b> A.hy	<b>Alarm (1 to 4) Hysteresis</b> Set the hysteresis for an alarm. This determines how far into the safe region the process value needs to move before the alarm can be cleared.	0.001 to 9,999.000 °F or units 0.001 to 5,555.000 °C	1.0 °F or units 1.0 °C	<b>Instance 1</b> Map 1    Map 2 1484    1884	0x6D (109) 1 to 4 3	24	9003	float RWES
<b>ALG</b> A.Lg	<b>Alarm (1 to 4) Logic</b> Select what the output condition will be during the alarm state.	<b>ALC</b> Energize on alarm (17) <b>ALo</b> De-energize on alarm (66)	Close On Alarm	<b>Instance 1</b> Map 1    Map 2 1488    1888	0x6D (109) 1 to 4 5	25	9005	uint RWES
<b>ASd</b> A.Sd	<b>Alarm (1 to 4) Sides</b> Select which side or sides will trigger this alarm.	<b>both</b> Both (13) <b>high</b> High (37) <b>low</b> Low (53)	Both	<b>Instance 1</b> Map 1    Map 2 1486    1886	0x6D (109) 1 to 4 4	26	9004	uint RWES

\* These parameters/prompts are available in these menus with firmware revisions 11.0 and above.

\*\* R: Read, W: Write, E: EEPROM, S: User Set

## Setup Page

Display	Parameter Name Description	Range	Default	Modbus Relative Address	CIP - Class Instance Attribute hex (dec)	Pro-fibus Index	Parameter ID	Data Type and Access **
<b>A.Lo</b> A.Lo	<b>Alarm (1 to 4) Low Set Point</b> If Type (Setup Page, Alarm Menu) is set to: Process - set the process value that will trigger a low alarm. Deviation - set the span of units from the closed loop set point that will trigger a low alarm. A negative set point represents a value below closed loop set point. A positive set point represents a value above closed loop set point.	-1,999.000 to 9,999.000 °F or units -1,128.000 to 5,537.000 °C	32.0 °F or units 0.0 °C	<b>Instance 1</b> Map 1 Map 2 1482 1882  Offset to next instance (Map 1 +50, Map 2 +60)	0x6D (109) 1 to 4 2	18	9002	float RWES
<b>A.hi</b> A.hi	<b>Alarm (1 to 4) High Set Point</b> If Type (Setup Page, Alarm Menu) is set to: Process - set the process value that will trigger a high alarm. Deviation - set the span of units from the closed loop set point that will trigger a high alarm.	-1,999.000 to 9,999.000 °F or units -1,128.000 to 5,537.000 °C	300.0 °F or units 150.0 °C	<b>Instance 1</b> Map 1 Map 2 1480 1880  Offset to next instance (Map 1) equals +50  Offset to next instance (Map 2) equals +60	0x6D (109) 1 to 4 1	19	9001	float RWES

\* These parameters/prompts are available in these menus with firmware revisions 11.0 and above.

\*\* R: Read, W: Write, E: EEPROM, S: User Set

## Setup Page

Display	Parameter Name Description	Range	Default	Modbus Relative Address	CIP - Class Instance Attribute hex (dec)	Pro-fibus Index	Parameter ID	Data Type and Access **
<b>ALA</b> A.LA	<b>Alarm (1 to 4) Latching</b> Turn latching on or off. A latched alarm has to be turned off by the user.	<b>nLAL</b> Non-Latching (60) <b>LAL</b> Latching (49)	Non-Latching	<b>Instance 1</b> Map 1 Map 2 1492 1892	0x6D (109) 1 to 4 7	27	9007	uint RWES
<b>ABL</b> A.bL	<b>Alarm (1 to 4) Blocking</b> Select when an alarm will be blocked. After start-up and/or after the set point changes, the alarm will be blocked until the process value enters the normal range.	<b>oFF</b> Off (62) <b>StAr</b> Startup (88) <b>SEPt</b> Set Point (85) <b>both</b> Both (13)	Off	<b>Instance 1</b> Map 1 Map 2 1494 1894	0x6D (109) 1 to 4 8	28	9008	uint RWES
<b>AS</b> A.Si	<b>Alarm (1 to 4) Silencing</b> Turn silencing on to allow the user to disable this alarm.	<b>oFF</b> Off (62) <b>on</b> On (63)	Off	<b>Instance 1</b> Map 1 Map 2 1490 1890	0x6D (109) 1 to 4 6	29	9006	uint RWES
<b>AdSP</b> A.dSP	<b>Alarm (1 to 4) Display</b> Display an alarm message when an alarm is active.	<b>oFF</b> Off (62) <b>on</b> On (63)	On	<b>Instance 1</b> Map 1 Map 2 1510 1910	0x6D (109) 1 to 4 0x10 (16)	30	9016	uint RWES

\* These parameters/prompts are available in these menus with firmware revisions 11.0 and above.

\*\* R: Read, W: Write, E: EEPROM, S: User Set

## Setup Page

Display	Parameter Name Description	Range	Default	Modbus Relative Ad- dress	CIP - Class Instance Attribute hex (dec)	Pro- fibus Index	Param- eter ID	Data Type and Access **
<i>A.dL</i> A.dL	<b>Alarm (1 to 4) Delay Time</b> Set the span of time that the alarm will be delayed after the process value exceeds the alarm set point.	0 to 9,999 seconds	0	<b>Instance 1</b> Map 1 Map 2 1520 1920  Offset to next in-stance (Map 1 equals +50, for Map 2 equals +60)	0x6D (109) 1 to 4 0x15 (21)	31	9021	uint RWES
<i>A.Clr</i> A.Clr	<b>Alarm (1 to 4) Clear Alarm</b> Write to this register to clear an alarm  <b>Note:</b> If an alarm is set-up to latch when active <i>A.Clr</i> will appear on the display.	<i>A.Clr</i> Clear (0) <i>Ignore</i> Ignore (204)	-----	Instance 1 Map 1 Map 2 1504 1904  Offset to next in-stance (Map1 1 equals +50, Map 2 equals +60)	0x6D (109) 1 to 4 0xD (13)	-----	9013	uint W
<i>A.Sil</i> A.Sil	<b>Alarm (1 to 4) Silence Alarm</b> Write to this register to silence an alarm  <b>Note:</b> If an alarm is setup to silence alarm when active <i>A.Sil</i> will appear on the display.	<i>Silence</i> Silence (1010)	-----	<b>Instance 1</b> Map 1 Map 2 1506 1906  Offset to next in-stance (Map1 1 equals +50, Map 2 equals +60)	0x6D (109) 1 to 4 0xE (14)	-----	9014	uint W
<i>A.St</i> A.St	<b>Alarm (1 to 4) Alarm State</b> Current state of alarm	<i>Start</i> Startup (88) <i>none</i> None (61) <i>Block</i> Blocked (12) <i>ALL</i> Alarm low (8) <i>ALh</i> Alarm high (7) <i>ALe</i> Error (28)	-----	<b>Instance 1</b> Map 1 Map 2 1496 1896  Offset to next in-stance (Map1 1 equals +50, Map 2 equals +60)	0x6D (109) 1 to 4 9	-----	9009	uint R

\* These parameters/prompts are available in these menus with firmware revisions 11.0 and above.

\*\* R: Read, W: Write, E: EEPROM, S: User Set

## Setup Page

Display	Parameter Name Description	Range	Default	Modbus Relative Ad- dress	CIP - Class Instance Attribute hex (dec)	Pro- fibus Index	Param- eter ID	Data Type and Access **
<b>Timer Menu</b>								
<b>ti.En</b>	<b>Timer (1) Timer Enable</b> Enable the timer function.	<b>YES</b> Yes (106) <b>no</b> No (59)	Yes	<b>Instance 1</b> Map 1 Map 2 4626 8556	0x83 (131) 1 0x1D (29)	- - - -	31029	uint RWES
<b>ti.St</b>	<b>Timer (1) Timer Start Method</b> Select what will start the timer.	<b>Imm</b> Immediate (1049) <b>rdy</b> Ready Band (1942) <b>rdyA</b> Ready Ack (1950) <b>PU</b> Power (73)	Immedi- ate	<b>Instance 1</b> Map 1 Map 2 4628 8558	0x83 (131) 1 0x1E (30)	- - - -	31030	uint RWES
<b>SFn.A</b>	<b>Timer (1) Source Function A</b> Select which input will start or termi- nate the timer.	<b>FUn</b> Function Key (1001) <b>nonE</b> None (61) <b>dio</b> Digital I/O (1142)	Function Key	<b>Instance 1</b> Map 1 Map 2 4570 8500	0x83 (131) 1 0x01 (1)	- - - -	31001	uint RWES
<b>Si.A</b>	<b>Timer (1) Source Instance A</b> Select an instance of Function A.	1 to 24	8	<b>Instance 1</b> Map 1 Map 2 4574 8504	0x83 (131) 1 0x03 (3)	- - - -	31003	uint RWES
<b>SFn.C</b>	<b>Timer (1) Source Function C</b> Select the analog source for the ready band.	<b>Pu</b> Process Value (241) <b>nonE</b> None (61) <b>AI</b> Analog Input (142) <b>Lnr</b> Linearization (238)	Process Value	<b>Instance 1</b> Map 1 Map 2 4630 8560	0x83 (131) 1 0x1F (31)	- - - -	31031	uint RWES
<b>Si.C</b>	<b>Timer (1) Source Instance C</b> Select an instance of Function C.	1 to 24	1	<b>Instance 1</b> Map 1 Map 2 4634 8564	0x83 (131) 1 0x21 (33)	- - - -	31033	uint RWES
<b>SFn.D</b>	<b>Timer (1) Source Function D</b> Select which input will acknowledge the ready band.	<b>FUn</b> Function Key (1001) <b>nonE</b> None (61) <b>dio</b> Digital I/O (1142)	Function Key	<b>Instance 1</b> Map 1 Map 2 4632 8562	0x83 (131) 1 0x20 (32)	- - - -	31032	uint RWES

\* These parameters/prompts are available in these menus with firmware revisions 11.0 and above.

\*\* R: Read, W: Write, E: EEPROM, S: User Set

\* Available with PM4, PM8 and PM9 models only

## Setup Page

Display	Parameter Name Description	Range	Default	Modbus Relative Ad- dress	CIP - Class Instance Attribute hex (dec)	Pro- fibus Index	Param- eter ID	Data Type and Access **
<b>Si.d</b> Si.d	<b>Timer (1)</b> <b>Source Instance D</b> Select an instance of Function D.	1 to 24	7	<b>Instance 1</b> Map 1    Map 2 4636    8566	0x83 (131) 1 0x22 (34)	- - - -	31034	uint RWES
<b>t.r</b> t.r	<b>Timer (1)</b> <b>Time Remaining</b> Display the time remaining on the timer.	00:00 to 99:59	7	- - - -	0x83 (131) 1 0x15 (21)	- - - -	31021	string R
<b>r.bS</b> r.bS	<b>Timer (1)</b> <b>Ready Band State</b> Display whether the process value is in the ready band.	<b>YES</b> Yes (106) <b>no</b> No (59)	- - - -	<b>Instance 1</b> Map 1    Map 2 4612    8542	0x83 (131) 1 0x16 (22)	- - - -	31022	uint R
<b>rdY</b> rdY	<b>Timer (1)</b> <b>Ready Band</b> Set the how close the process value must be to the closed loop timer set point to be in the ready band.	0.000 to 9999.000 °F or units 0.000 to 5555.000 °C	5.000	<b>Instance 1</b> Map 1    Map 2 4614    8544	0x83 (131) 1 0x17 (23)	- - - -	31023	float RWES
<b>t.For</b> t.For	<b>Timer (1)</b> <b>Time Format</b> Select the time for- mat.	<b>tPqS</b> Time Minutes:Seconds (1943) <b>tHqQ</b> Time Hours:Minutes (1944)	Time Minutes: Seconds	<b>Instance 1</b> Map 1    Map 2 4616    8546	0x83 (131) 1 0x18 (24)	- - - -	31024	uint RWES
<b>hoUr</b> hoUr	<b>Timer (1)</b> <b>Hours</b> Set the timer period hours.	0 to 99	0	<b>Instance 1</b> Map 1    Map 2 4618    8548	0x83 (131) 1 0x19 (25)	- - - -	31025	uint RWES
<b>Min</b> Min	<b>Timer (1)</b> <b>Minutes</b> Set the timer period minutes.	0 to 59	0	<b>Instance 1</b> Map 1    Map 2 4620    8550	0x83 (131) 1 0x1A (26)	- - - -	31026	uint RWES
<b>SEC</b> SEC	<b>Timer (1)</b> <b>Seconds</b> Set the timer period seconds.	0 to 59	10	<b>Instance 1</b> Map 1    Map 2 4622    8552	0x83 (131) 1 0x1B (27)	- - - -	31027	uint RWES

\* These parameters/prompts are available in these menus with firmware revisions 11.0 and above.

\*\* R: Read, W: Write, E: EEPROM, S: User Set

## Setup Page

Display	Parameter Name Description	Range	Default	Modbus Relative Address	CIP - Class Instance Attribute hex (dec)	Pro-fibus Index	Parameter ID	Data Type and Access **
<b>CLSP</b> Ct.SP	<b>Timer (1) Closed Loop Timer Set Point</b> Set the set point that will be in effect during the timer period.	-1999.000 to 9999.000°F or units -1110.555 to 5555.000°C	75	<b>Instance 1</b> Map 1    Map 2 4624    8554	0x83 (131) 1 0x1C (28)	- - - -	31028	float RWES
<b>SESt</b>	<b>Timer (1) Signal Time</b> Set the period of time that a signal output to be activated after the timer period is complete. Assign a digital output for this function in Timer Event Output 3.	1 to 3600 Seconds	1	<b>Instance 1</b> Map 1    Map 2 4658    8588	0x83 (131) 1 0x2D (45)	- - - -	31045	uint RWES
<b>FUN</b> <b>SEt</b> <b>Function Key</b>								
<b>LEv</b> LEv	<b>Function Key (1 to 2) Active Level</b> The Function Key will always power up in the low state. Pressing the Function Key will toggle the selected action.	<b>h,gh</b> High (37) <b>Low</b> Low (53)	High	<b>Instance 1</b> Map 1    Map 2 1360    1600 <b>Instance 2</b> Map 1    Map 2 1380    1620	0x6E (110) 1 to 2 1	137	10001	uint RWES

\* These parameters/prompts are available in these menus with firmware revisions 11.0 and above.

\*\* R: Read, W: Write, E: EEPROM, S: User Set

## Setup Page

Display	Parameter Name Description	Range	Default	Modbus Relative Address	CIP - Class Instance Attribute hex (dec)	Pro-fibus Index	Parameter ID	Data Type and Access **
<i>F<sub>n</sub></i> Fn	<p><i>Function Key (1 to 2)</i></p> <p><b>Action Function</b> Program the EZ Key to trigger an action. Functions respond to a level state change or an edge level change.</p>	<p><i>nonE</i> None (61)</p> <p><i>r.En</i> Remote Set Point (216)</p> <p><i>L.P.r</i> Limit Reset, edge triggered (82)</p> <p><i>uS.r.r</i> User Set Restore, edge triggered (227)</p> <p><i>P.L.o.C</i> Keypad Lock-out, level triggered (217)</p> <p><i>AL.P.r</i> Alarm Reset, edge triggered (6)</p> <p><i>S.i.L</i> Silence Alarms, edge triggered (108)</p> <p><i>A.o.F</i> Control Loops Off and Alarms to Non-alarm State, level triggered (220)</p> <p><i>F.AL</i> Force Alarm to occur, level triggered (218)</p> <p><i>i.d.L.E</i> Idle Set Point, level triggered (107)</p> <p><i>t.U.n.E</i> Tune, edge triggered (98)</p> <p><i>P.r.A.n</i> Manual, level triggered (54)</p> <p><i>o.F.F</i> Switch Control Loop Off, level triggered (90)</p> <p><i>t.d.R</i> TRU-TUNE+® Disable, level triggered (219)</p> <p><i>P.d.i.S</i> Profile Disable, level triggered (206)</p> <p><i>P.h.o.L</i> Profile Hold/Resume, level triggered (207)</p> <p><i>P.r.o.F</i> Start Profile, edge triggered (196)</p> <p><i>P.S.t.S</i> Profile Start/Stop, level triggered (208)</p> <p><i>S.S.t.P</i> Start Step (1077)</p>	None	<p><b>Instance 1</b> Map 1 Map 2 1364 1604</p> <p><b>Instance 2</b> Map 1 Map 2 1384 1624</p>	0x6E (110) 3 to 4 3	138	10003	uint RWES

\* These parameters/prompts are available in these menus with firmware revisions 11.0 and above.

\*\* R: Read, W: Write, E: EEPROM, S: User Set



## Setup Page

Display	Parameter Name Description	Range	Default	Modbus Relative Address	CIP - Class Instance Attribute hex (dec)	Pro-fibus Index	Parameter ID	Data Type and Access **
<b>Fi</b>	<b>Function Key (1 to 2)</b> <b>Function Instance</b> Select which instance the EZ Key will affect. If only one instance is available, any selection will affect it.	0 to 40	0	<b>Instance 1</b> Map 1 1366    Map 2 1606 <b>Instance 2</b> Map 1 1386    Map 2 1626	0x96 (110) 3 to 4 4	139	10004	- - - -
<b>9LbL</b> <b>SEt</b> <b>Global Menu</b>								
<b>C_F</b>	<b>Global Display Units</b> Select which scale to use for temperature.	<b>F</b> °F (30) <b>C</b> °C (15)	°F	<b>Instance 1</b> Map 1 1838    Map 2 2308	0x67 (103) 1 5	110	3005	uint RWES
<b>ACLF</b>	<b>Global AC Line Frequency</b> Set the frequency to the applied ac line power source.	<b>50</b> 50 Hz (3) <b>60</b> 60 Hz (4)	60 Hz	<b>Instance 1</b> Map 1 886    Map 2 1006	0x6A (106) 1 4	89	1034	uint RWES
<b>r.tyP</b>	<b>Global Ramping Type</b>	<b>rAte</b> Rate (81) <b>t</b> Time (143)	Time	<b>Instance 1</b> Map 1 - - - -    Map 2 4414	0x7A (122) 1 26 (38)	- - - -	22038	uint RWE
<b>P.tyP</b>	<b>Global Profile Type</b> Set the profile startup to be based on a set point or a process value.	<b>SEt</b> Set Point (85) <b>Pro</b> Process (75)	Set Point	<b>Instance 1</b> Map 1 2534    Map 2 4354	0x7A (122) 1 8	- - - -	22008	uint RWE
<b>gSE</b>	<b>Global Guaranteed Soak Enable</b> Enables the guaranteed soak deviation function in profiles.	<b>oFF</b> Off (62) <b>oN</b> On (63)	Off	<b>Instance 1</b> Map 1 2530    Map 2 4350	0x7A (122) 1 6	- - - -	22006	uint RWE

\* These parameters/prompts are available in these menus with firmware revisions 11.0 and above.

\*\* R: Read, W: Write, E: EEPROM, S: User Set

## Setup Page

Display	Parameter Name Description	Range	Default	Modbus Relative Ad- dress	CIP - Class Instance Attribute hex (dec)	Pro- fibus Index	Param- eter ID	Data Type and Access **
95d1 gSd1	<b>Global Guaranteed Soak Deviation 1</b> Set the value of the deviation band that will be used in all profile step types. The process value must enter the deviation band before the step can proceed.	0.0 to 9,999.000 °F or units 0.0 to 5,555.000 °C	10.0 °F or units 6.0 °C	<b>Instance 1</b> Map 1 Map 2 2532 4352	0x7A (122) 1 7	- - - -	22007	float RWE
5.A Si.a	<b>Global Source Instance A</b> Set the digital source for Wait for Event 1 in profile.	5 to 12	5	<b>Instance 1</b> Map 1 Map 2 - - - - 4390	0x7A (122) 1 0x1A (26)	- - - -	22060	uint RWES
5.b Si.b	<b>Global Source Instance B</b> Set the digital source for Wait for Event 2 in profile.	5 to 12	5	<b>Instance 1</b> Map 1 Map 2 - - - - 4392	0x7A (122) 1 0x1B (27)	- - - -	22061	uint RWES
Pot1 Poti	<b>Global Power Off Time</b> If profile is running and power is lost, profile will resume where it left off provided time set has not expired prior to power res- toration.	0 to 9999 seconds	0	<b>Instance 1</b> Map 1 Map 2 - - - - 4484	0x7A (122) 1 0x49 (73)	- - - -	22073	uint RWE
5.6b Svtb	<b>Global Synchronized Vari- able Time Base</b> Used to acquire tighter accuracy when running a profile. A setting of +0.01 would equate to approxi- mately +9 sec- onds/day (faster) where a setting of -0.01 would equate to approximately -9 seconds/day (slower).	-2 to 2 %	0.00	- - - -	- - - -	- - - -	- - - -	float RWE

\* These parameters/prompts are available in these menus with firmware revisions 11.0 and above.

\*\* R: Read, W: Write, E: EEPROM, S: User Set

## Setup Page

Display	Parameter Name Description	Range	Default	Modbus Relative Address	CIP - Class Instance Attribute hex (dec)	Pro-fibus Index	Parameter ID	Data Type and Access **
<b>C.LEd</b> C.LEd	<b>Global Communications LED Action</b> Turns comms LED on or off for selected comms ports.	<b>On 1</b> Comm port 1 (1189) <b>Off</b> Off (62)	Comm port 1	<b>Instance 1</b> Map 1 1856    Map 2 2326	0x6A (103) 1 0x0E (14)	- - - -	3014	uint RWES
<b>Zone</b> Zone	<b>Global Zone</b> Turns Zone LED on or off based on selection.	<b>Off</b> Off (62) <b>On</b> On (63)	On	<b>Instance 1</b> Map 1 - - - -    Map 2 2350	0x6A (103) 1 0x1A (26)	- - - -	3026	uint RWES
<b>Chan</b> Chan	<b>Global Channel</b> Turns Channel LED on or off based on selection.	<b>Off</b> Off (62) <b>On</b> On (63)	On	<b>Instance 1</b> Map 1 - - - -    Map 2 2352	0x6A (103) 1 0x1B (27)	- - - -	3027	uint RWES
<b>d.PrS</b> d.PrS	<b>Global Display Pairs</b> Defines the number of Display Pairs.	1 to 10	2	<b>Instance 1</b> Map 1 - - - -    Map 2 2354	0x6A (103) 1 0x1C (28)	- - - -	3028	uint RWES
<b>d.ti</b> d.ti	<b>Global Display Time</b> Time delay in toggling between Display Pairs.	0 to 60	0	<b>Instance 1</b> Map 1 - - - -    Map 2 2356	0x6A (103) 1 0x1D (29)	- - - -	3029	uint RWES
<b>USr.S</b> USr.S	<b>Global Save Settings As</b> Save all of this controller's settings to the selected set.	<b>SEt 1</b> User Set 1 (101) <b>SEt 2</b> User Set 2 (102) <b>nonE</b> None (61)	None	<b>Instance 1</b> Map 1 26    Map 2 26	0x(101) 1 0xE (14)	118	1014	uint RWE
<b>USr.r</b> USr.r	<b>Global Restore Settings From</b> Replace all of this controller's settings with another set.	<b>FACTY</b> Factory (31) <b>nonE</b> None (61) <b>SEt 1</b> User Set 1 (101) <b>SEt 2</b> User Set 2 (102)	None	<b>Instance 1</b> Map 1 24    Map 2 24	0x65 (101) 1 0xD (13)	117	1013	uint RWE

\* These parameters/prompts are available in these menus with firmware revisions 11.0 and above.  
 \*\* R: Read, W: Write, E: EEPROM, S: User Set

## Setup Page

Display	Parameter Name Description	Range	Default	Modbus Relative Address	CIP - Class Instance Attribute hex (dec)	Pro-fibus Index	Parameter ID	Data Type and Access **
<b>COPY</b> <b>SET</b> <b>Communications Menu</b>								
<b>PCoL</b> PCoL	<b>Communications Protocol</b> Set the protocol of this controller to the protocol that this network is using.	<b>Std</b> Standard Bus (1286) <b>Mod</b> Modbus RTU (1057)	Modbus	<b>Instance 1</b> Map 1    Map 2 2492    2972	0x96 (150) 1 7	- - - -	17009	uint RWE
<b>Standard Bus</b>								
<b>Ad.S</b> Ad.S	<b>Communications Standard Bus Address</b> Set the network address of this controller. Each device on the network must have a unique address. The Zone Display on the front panel will display this number.	1 to 16	1	<b>Instance 1</b> Map 1    Map 2 2480    2960	0x96 (150) 1 1	- - - -	17001	uint RWE
<b>Modbus RTU</b>								
<b>Ad.M</b> Ad.M	<b>Communications Modbus Address</b> Set the network address of this controller. Each device on the network must have a unique address.	1 to 247	1	<b>Instance 1</b> Map 1    Map 2 2482    2962	0x96 (150) 1 2	- - - -	17007	uint RWE
<b>BAUD</b> bAUd	<b>Communications Baud Rate</b> Set the speed of this controller's communications to match the speed of the Modbus serial network.	<b>9600</b> 9,600 (188) <b>192</b> 19,200 (189) <b>384</b> 38,400 (190)	9,600	<b>Instance 1</b> Map 1    Map 2 2484    2964	0x96 (150) 1 3	- - - -	17002	uint RWE

\* These parameters/prompts are available in these menus with firmware revisions 11.0 and above.

\*\* R: Read, W: Write, E: EEPROM, S: User Set

## Setup Page

Display	Parameter Name Description	Range	Default	Modbus Relative Address	CIP - Class Instance Attribute hex (dec)	Pro-fibus Index	Parameter ID	Data Type and Access **
PAR PAR	<b>Communications Parity</b> Set the parity of this controller to match the parity of the Modbus serial network.	none None (61) Even Even (191) odd Odd (192)	None	<b>Instance 1</b> Map 1 Map 2 2486 2966	0x96 (150) 1 to 2 4	- - - -	17003	uint RWE
C_F C_F	<b>Communications Display Units</b> Select whether this communications channel will display in Celsius or Fahrenheit.  <b>Note:</b> Applies to Modbus only.	F Fahrenheit (30) C Celsius (15)	F	<b>Instance 1</b> Map 1 Map 2 2490 2970	0x96 (150) 1 6	- - - -	17050	uint RWE
M.HL M.HL	<b>Communications Modbus Word Order</b> Select the word order of the two 16-bit words in the floating-point values.	Low-High (1331) High-Low (1330)	Low-High	<b>Instance 1</b> Map 1 Map 2 2488 2968	0x96 (150) 1 to 2 5	- - - -	17043	uint RWE
Map Map	<b>Communications Data Map</b> If set to 1 the control will use PM legacy mapping. If set to 2 the control will use new mapping to accommodate new functions.	1 to 2	- - - -	- - - -	- - - -	- - - -	17059	uint RWE
n.V.S n.V.S	<b>Communications Non-Volatile Save</b> If set to Yes all values written to the control will be saved in EEPROM. The EEPROM allows for approximately one million writes.	Yes (106) No (59)	Yes	<b>Instance 1</b> Map 1 Map 2 2494 2974	0x96 (150) 1 8	198	17051	uint RWE
no display	<b>Communications Tick</b> Value increases at 1mS rate.	0 to 4,294,967,295	- - - -	<b>Instance 1</b> Map 1 Map 2 5020 8950	- - - -	- - - -	16006	un- signed 32-bit RWE

\* These parameters/prompts are available in these menus with firmware revisions 11.0 and above.

\*\* R: Read, W: Write, E: EEPROM, S: User Set

## Setup Page

Display	Parameter Name Description	Range	Default	Modbus Relative Address	CIP - Class Instance Attribute hex (dec)	Pro-fibus Index	Parameter ID	Data Type and Access **
<div style="display: flex; justify-content: space-between; align-items: center;"> <span style="color: red; font-family: monospace;">r t C</span> <span style="color: green; font-family: monospace;">S E t</span> </div> <p><b>Real Time Clock Menu</b></p>								
<span style="color: green; font-family: monospace;">h o U r</span> hoUr	<i>Real Time Clock</i> <b>Hours</b> Set the current time.	0 to 23	0	<i>Instance 1</i> Map 1    Map 2 - - - -    4004	88 (136) 1 3	- - - -	36003	uint RW
<span style="color: green; font-family: monospace;">m i n</span> Min	<i>Real Time Clock</i> <b>Minutes</b> Set the current time.	0 to 59	0	<i>Instance 1</i> Map 1    Map 2 - - - -    4006	88 (136) 1 4	- - - -	36004	uint RW
<span style="color: green; font-family: monospace;">d o W</span> doW	<i>Real Time Clock</i> <b>Day of Week</b> Set the current day of the week.	<span style="color: red; font-family: monospace;">S u n</span> Sunday (1565) <span style="color: red; font-family: monospace;">M o n</span> Monday (1559) <span style="color: red; font-family: monospace;">T u e</span> Tuesday (1560) <span style="color: red; font-family: monospace;">W e d</span> Wednesday (1561) <span style="color: red; font-family: monospace;">T h u</span> Thursday (1562) <span style="color: red; font-family: monospace;">F r i</span> Friday (1563) <span style="color: red; font-family: monospace;">S a t</span> Saturday (1564)	Sun	<i>Instance 1</i> Map 1    Map 2 - - - -    4002	88 (136) 1 2	- - - -	36002	uint RW
* These parameters/prompts are available in these menus with firmware revisions 11.0 and above. ** R: Read, W: Write, E: EEPROM, S: User Set								

# 7

## Chapter 7: Profiling Page

### Navigating the Profiling Page

#### Note:

Some of these menus and parameters may not appear, depending on the controller's options. See model number information in the Appendix for more information. If there is only one instance of a menu, no submenus will appear.

### Profile Setup

First, consider some foundational profile *setup* features that once configured, will apply to all configured profiles. The screen shot below (EZ-ZONE Configurator software) graphically shows the settings (shaded green) that will apply to all profiles; e.g., if Guaranteed Soak is not enabled here this feature will not be available in any individual profile configuration.

Some of those features that apply to all profiles are listed below with a brief description of their function.

- **Ramping Type** (Time or Rate) which changes the profile set point based on a set interval of time or set rate.

- **Profile Type** (Set Point or Process) determines whether a step (any step changing the set point) of a profile will begin by using the process value (Process) or the last closed-loop set point (Set Point).

- **Guaranteed Soak Enable**, when set to on makes this feature available in all profiles. If Guaranteed Soak Enable is on, use Guaranteed Soak Deviation 1 to 2 to set the value for the corresponding loop. Set the deviation or band above or below the working set point where this condition must be met before the profile can proceed.

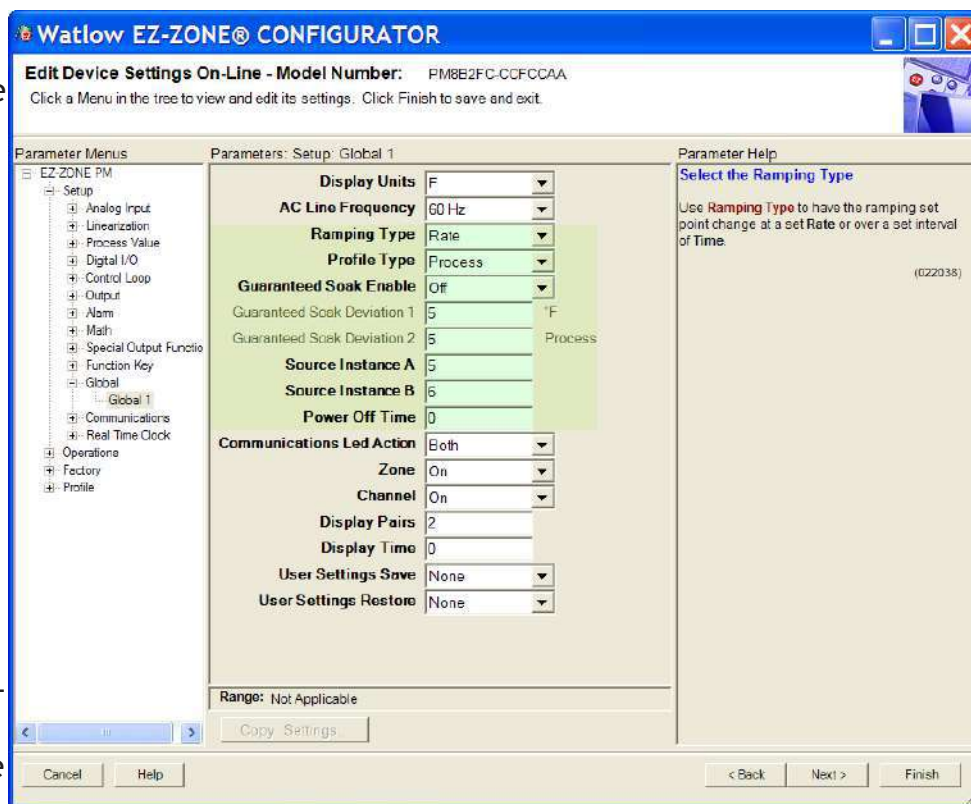













#### Note:

Changes made to profile parameters in the Profiling Pages will be saved and take effect on the next pass through the step. Changes made in the Profile Status page effect the current step being executed and do not update the step setting in the profiling page. Changing profiles should only be changed by knowledgeable personnel and with caution.

Once these global profile features are configured, the next step will require navigation to the Profiling Page. Here, each desired ramp and soak profile will be configured.

To navigate to the Profile Page from the front panel, follow the steps below:

1. From the Home Page, press and hold the Advance Key  for approximately five seconds. The profile prompt *Pr o F* will appear in the lower display and the profile number (e.g. *P 1*) appears in the upper display.
2. Press the Up  or Down  key to change to another profile (1 to 4).
3. Press the Advance Key  to move to the selected profiles first step.
4. Press the Up  or Down  keys to move through and select the step type.
5. Press the Advance Key  to move through the selected step settings.
6. Press the Up  or Down  keys to change the steps settings.
7. Press the Infinity Key  at any time to return to the step number prompt.
8. Press the Infinity Key  again to return to the profile number prompt.
9. From any point press and hold the Infinity Key  for two seconds to return to the Home Page.

If using EZ-ZONE Configurator software, simply click on the plus sign next to Profiles in the left hand column, as shown in the screen shot below.

Notice in the screen shot to the right some fields or parameters are not selectable (grayed out) based on the Step Type that is selected.

## Starting a Profile

There are several ways to start a profile. Some of the examples that follow requires that certain optional hardware be available on the control. If you are uncertain as to how your control is equipped, compare the part number of your control to the "Ordering Information" page found in the Appendix of this Users Guide.

Three ways to start a profile:

- Function Key
- Digital Input
- Profile Request

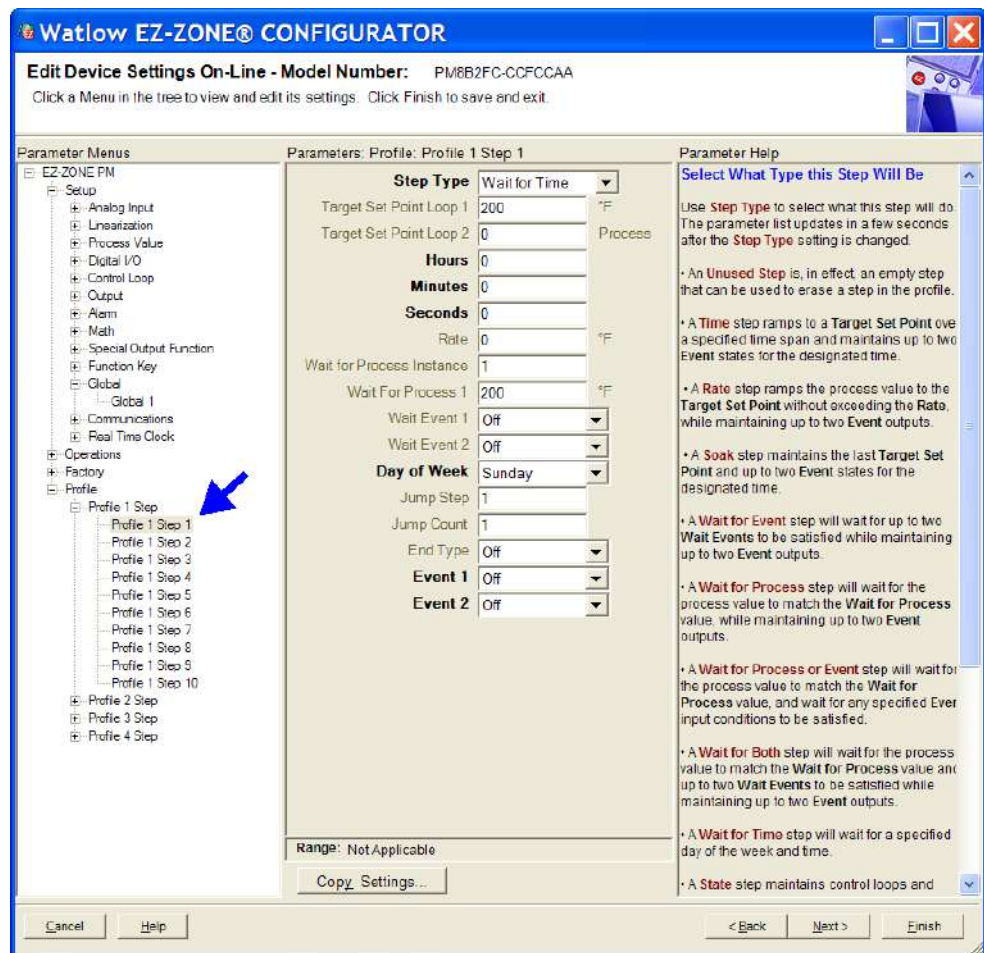



## Configuring the Function Key to Start and Stop a Profile

1. Navigate to the Setup Page and then the Function menu. From the Home Page, press and hold the **▲** or Down **▼** key for approximately six seconds where the upper display will show **A**, and the lower display will show **SEt**.
2. Press the Up **▲** or Down **▼** key to navigate to the Function **FUn** menu.
3. Press the Advance Key **↻** to enter this menu. The upper display will show **f** and the lower display will show **FUn**.
4. Press the Advance Key **↻** to select the level. The upper display will show **h**, **9h** and the lower display will show **LEu**.
5. Press the Up **▲** or Down **▼** keys to select the level that will start the profile (high or low).
6. Press the Advance Key **↻** to select the function. In this example, select Profile Start / Stop **PStS**.
7. Press the Advance Key **↻** to select the function instance (Profile to start).
8. Return to the Home Page by pressing and holding the Infinity Key **∞** for approximately three seconds.

### Note:







The state of the EZ-Function Key (high or low) is maintained with each successive push of the key.

## Configuring a Digital Input to Start and Stop a Profile

1. Navigate to the Setup Page and then the Digital I/O menu. From the Home Page, press and hold the **▲** or Down **▼** key for approximately six seconds where the upper display will show **A**, and the lower display will show **SEt**.
2. Press the Up **▲** or Down **▼** key to navigate to the Digital I/O menu. Upper display will show **d**, **io** and the lower display will show **SEt**.
3. Press the Advance Key **↻** where the first available digital instance will be displayed in the upper display.
4. Press the Up **▲** or Down **▼** key to select the input of choice.
5. Press the Advance Key **↻** to select the direction (input or output). In this example, select Dry Contact **iCon**.
6. Select the level (high or low) that will activate the function by pressing the Advance Key **↻** where the upper display will show **h**, **9h** and the lower display will show **LEu**.
7. Press the Up **▲** or Down **▼** keys to select the level that will start the profile (high = closed or low = open).
8. Press the Advance Key **↻** to select the function **Fn**. In this example, select Profile Start / Stop **PStS**.
9. Press the Advance Key **↻** to select the function instance (Profile to start).
10. Return to the Home Page by pressing and holding the Infinity Key **∞** for approximately three seconds.

## Starting a Profile from the Operations Page

1. Navigate to the Operations Page and then the Profile Status menu. From the Home Page, press and hold the **▲** or Down **▼** key for approximately three seconds where the upper display will show **A**, and the lower display will show **oPEr**.
2. Press the Up **▲** or Down **▼** key to navigate to the Profile Status **PStA** menu.

3. Press the Advance Key  to enter this menu. The upper display will show *I* and the lower display will show *P.5tR*.
4. Press the Up  or Down  keys to select the Profile or Step to start. In this example select 1.
5. Press the Advance Key  to select the Profile Action Request. The upper display will show *nonE* and the lower display will show *P.ACr*.
6. Press the Up  or Down  keys to select the Profile start. The upper display will show *PrOF* and the lower display will show *P.ACr*.





**Note:**

As soon as the Green Advance Key  is pressed (step 7 below) the designated Profile or Step (as determined in step 4 above) will start.

7. Press the Advance Key  to select whether Event 1 will be on or off. The upper display will show *oFF* and the lower display will show *Ent 1*.



**Note:**

This setting will temporally override the profile configuration.











8. Press the Up  or Down  keys to select whether Event 1 will be on or off. This will immediately drive the Event to the specified state regardless of the Profile configuration.
9. Press the Advance Key  to select whether Event 2 will be on or off. The upper display will show *oFF* and the lower display will show *Ent 2*.
10. Press the Up  or Down  keys to select whether Event 2 will be on or off. This will immediately drive the Event to the specified state regardless of the Profile configuration.

**Note:**







The event state will be as left when the profile ended and may be toggled at the profile status menu.

11. Press the Advance Key  to see the current Jump Count. The upper display will show *J* and the lower display will show *JC*.
12. Return to the Home Page by pressing and holding the Infinity Key  for approximately three seconds.



### Ending a Profile from the Operations Page

1. Navigate to the Operations Page and then the Profile Status menu. From the Home Page, press and hold the Up  or Down  key for approximately three seconds where the upper display will show *RI* and the lower display will show *oPER*.
2. Press the Up  or Down  key to navigate to the Profile Status *P.5tR* menu.
3. Press the Advance Key  to enter this menu. The upper display will show *I* and the lower display will show *P.5tR*.
4. Press the Advance Key  to select the Profile Action Request. The upper display will show *nonE* and the lower display will show *P.ACr*.
6. Press the Up  or Down  keys to select the End. The upper display will show *End* and the lower display will show *P.ACr*.
7. Press the Advance Key  to end the Profile.
8. Return to the Home Page by pressing and holding the Infinity Key  for approximately three seconds.

## Starting a Profile from the Home Page

1. When at the Home Page, press the Advance Key  to locate Profile Start and select the file or step number to start. The upper display will show *I* and the lower display will show *PSt I*.
2. Press the Up  or Down  key to choose the file or step number.
3. Press the Advance Key  to select the Profile Action Request. The upper display will show *nonE* and the lower display will show *PAC I*.
4. Press the Up  or Down  keys to select the Profile Start. The upper display will show *Pr oF* and the lower display will show *PAC I*.
5. Press the Infinity Key to return Home. The Profile will Start

## Ending a Profile from the Home Page

1. Press the Advance Key  to select the Profile Action Request. The upper display will show *nonE* and the lower display will show *PAC I*.
2. Press the Up  or Down  keys to select the End. The upper display will show *End* and the lower display will show *PAC I*.
3. Press the Infinity Key to return Home. The Profile will End.

## Profiling Parameters

*P I*

*Pr oF* Profile (1 to 4)

*I*

*P I* Profile [1 to 4] Step (1 to 40)

*StYP* Step Type

*tSP I* Target Set Point Loop 1

*hoUr* Hours

*Min* Minutes

*SEC* Seconds

*rAtE* Rate

*WdP I* Wait For Process 1

*WdE I* Wait For Event 1

*WdE 2* Wait for Event 2

*doWd* Day of Week

*JS* Jump Step

*JC* Jump Count

*End* End Type

*Ent I* Event 1

*Ent 2* Event 2

Profiling Page

Display	Parameter Name Description	Range	Default	Modbus Relative Address	CIP Class Instance Attribute hex (dec)	Pa- ram- eter ID	Data Type and Access **
---------	-------------------------------	-------	---------	-------------------------------	--	---------------------------	-------------------------------------

*P I*  
*Pr o F*  
Profiling Menu

<i>P I</i> to <i>P 4</i>	<b>Profile [1 to 4] Step</b> Select a step to edit or view.	1 to 10 [profile 1] 11 to 20 [profile 2] 21 to 30 [profile 3] 31 to 40 [profile 4]		----	----	----	----
<i>St y P</i> S.typ	<b>Step Type</b> Select a step type.  <b>Note:</b> Prior to selecting the Step Type consider whether or not profiles will be based on time or rate of change. By default, profiles are configured for Time <i>t i</i> . Therefore, Rate will not be available here. If it is desired to base profiles on rate of change, navigate to the Setup Page and then the Global Menu where Ramping Type can be changed from Time to Rate.	<i>UStP</i> Unused Step (50) <i>SoRH</i> Soak (87) <i>WdE</i> Wait For Event (144) <i>WdPr</i> Wait For Process (209) <i>WdBo</i> Wait For Both (210) <i>JL</i> Jump (116) <i>End</i> End (27) <i>CLoE</i> Wait For Time (1543) <i>t i</i> Time (143) <i>rAtE</i> Rate (81)	Unused	<b>Instance 1</b> Map 1 Map 2 2570 4500  Offset to next instance (Map 1 equals +50, Map 2 equals +100)	0x79 (121) 1 to 40 1	21001	uint RWE
<i>tSP 1</i> t.SP1	<b>Step Type Parameters</b> <b>Target Set Point Loop 1</b> When Step Type is Time or Rate, enter the closed loop set point for loop 1 to ramp to for this step.	-1,999.000 to 9,999.000 °F or units -1,128 to 5,537.000 °C	0.0 °F or units -18 °C	<b>Instance 1</b> Map 1 Map 2 2572 4502  Offset to next instance (Map 1 equals +50, Map 2 equals +100)	0x79 (121) 1 to 40 2	21002	float RWE

**Note:**

Some values will be rounded off to fit in the four-character display. Full values can be read with other interfaces.

\*\* R: Read, W: Write, E: EEPROM, S: User Set

Profiling Page

Display	Parameter Name Description	Range	Default	Modbus Relative Address	CIP Class Instance Attribute hex (dec)	Pa- ram- eter ID	Data Type and Access **
hoUr hoUr	<i>Step Type Parameters</i> <b>Hours</b> Select the hours (plus Min- utes and Seconds) for a timed step.	0 to 9999	0	<i>Instance 1</i> Map 1 Map 2 2574 4504  Offset to next in- stance (Map 1 equals +50, Map 2 equals +100)	0x79 (121) 1 to 40 3	21003	uint RWE
Min Min	<i>Step Type Parameters</i> <b>Minutes</b> When Step Type is Time, Soak, or Wait For Time enter Minutes (plus Hours and Sec- onds) for this step.	0 to 59	0	<i>Instance 1</i> Map 1 Map 2 2576 4506  Offset to next in- stance (Map 1 equals +50, Map 2 equals +100)	0x79 (121) 1 to 40 4	21004	uint RWE
SEC SEC	<i>Step Type Parameters</i> <b>Seconds</b> When Step Type is Time, Soak, or Wait For Time enter Seconds (plus Hours and Min- utes) for this step.	0 to 59	0	<i>Instance 1</i> Map 1 Map 2 2578 4508  Offset to next in- stance (Map 1 equals +50, Map 2 equals +100)	0x79 (121) 1 to 40 5	21005	uint RWE
rAtE rAtE	<i>Step Type Parameters</i> <b>Rate</b> When Step Type is Rate, en- ter the rate for ramping in degrees or units per minute.	0 to 9,999.000 °F or units per minute 0 to 5,555.000 °C per minute	0.0	<i>Instance 1</i> Map 1 Map 2 2580 4510  Offset to next in- stance (Map 1 equals +50, Map 2 equals +100)	0x79 (121) 1 to 40 6	21006	float RWE

**Note:**

Some values will be rounded off to fit in the four-character display. Full values can be read with other inter-  
faces.

\*\* R: Read, W: Write, E: EEPROM, S: User Set

Profiling Page

Display	Parameter Name Description	Range	Default	Modbus Relative Address	CIP Class Instance Attribute hex (dec)	Pa- ram- eter ID	Data Type and Access **
<b>W.P1</b>	<b>Step Type Parameters Wait For Process 1</b> When Step Type is Wait for Process or Wait For Both, enter wait for process value on analog input specified by Wait For Process Instance before proceeding in profile.	-1,999.000 to 9,999.000°F or units -1,128.000 to 5,537.000°C	0.0°F or units -18.0°C	<b>Instance 1</b> Map 1 2590 Map 2 4520  Offset to next in-stance (Map 1 equals +50, Map 2 equals +100)	0x79 (121) 1 to 40 0x0B (11)	21011	float RWE
<b>WE.1</b>	<b>Step Type Parameters Wait Event 1</b> When Step Type is Wait for Event or Wait For Both, select the event state that must be satisfied during this step. <b>Note:</b> Wait Event 1 can be mapped to any available digital input (5 - 12). Navigate to the Setup Page under the Global Menu to find and modify Source Instance A <b>S.iA</b> (Event 1) and Source Instance B <b>S.iB</b> (Event 2).	<b>OFF</b> Off (62) <b>ON</b> On (63) <b>none</b> None (61)	Off	<b>Instance 1</b> Map 1 2586 Map 2 4516  Offset to next in-stance (Map 1 equals +50, Map 2 equals +100)	0x79 (121) 1 to 10 9	21009	uint RWE
<b>WE.2</b>	<b>Step Type Parameters Wait Event 2</b> When Step Type is Wait for Event or Wait For Both, select the event state that must be satisfied during this step. <b>Note:</b> Wait Event 2 can be mapped to any available digital input (5 - 12). Navigate to the Setup Page under the Global Menu to find and modify Source Instance A <b>S.iA</b> (Event 1) and Source Instance B <b>S.iB</b> (Event 2).	<b>OFF</b> Off (62) <b>ON</b> On (63) <b>none</b> None (61)	Off	<b>Instance 1</b> Map 1 2588 Map 2 4518  Offset to next in-stance (Map 1 equals +50, Map 2 equals +100)	0x79 (121) 1 to 40 0xA (10)	21010	uint RWE

**Note:**

Some values will be rounded off to fit in the four-character display. Full values can be read with other interfaces.

\*\* R: Read, W: Write, E: EEPROM, S: User Set

Profiling Page

Display	Parameter Name Description	Range	Default	Modbus Relative Address	CIP Class Instance Attribute hex (dec)	Parameter ID	Data Type and Access **
<b>doW</b> doW	<b>Step Type Parameters Day of Week</b> When Step Type is Wait for Time, the profile waits until this Day of Week along with Hours, Minutes and Seconds time of day is met.	<b>Ed</b> Every Day (1567) <b>LUd</b> Week days (1566) <b>Sun</b> Sunday (1565) <b>Mon</b> Monday (1559) <b>TUE</b> Tuesday (1560) <b>LUEd</b> Wednesday (1561) <b>thUr</b> Thursday (1562) <b>Fr</b> , Friday (1563) <b>SAT</b> Saturday (1564)	Sunday	<b>Instance 1</b> Map 1 Map 2 - - - - 4580  Offset to next in-stance Map 2 equals +100)	0x79 (121) 1 to 40 0x29 (41)	21041	uint RWE
<b>JS</b> JS	<b>Step Type Parameters Jump Step</b> When Step Type is Jump, this specifies which step to jump back to. Jump Step must be a lower step number than the current step number.	1 to 40	0	<b>Instance 1</b> Map 1 Map 2 2592 4522  Offset to next in-stance (Map 1 equals +50, Map 2 equals +100)	0x79 (121) 1 to 40 0xC (12)	21012	uint RWE
<b>JC</b> JC	<b>Step Type Parameters Jump Count</b> When Step Type is Jump, this specifies the number of jumps to repeat. A value of 0 creates an infinite loop. Loops can be nested four deep.	0 to 9,999	0	<b>Instance 1</b> Map 1 Map 2 2594 4524  Offset to next in-stance (Map 1 equals +50, Map 2 equals +100)	0x79 (121) 1 to 40 0xD (13)	21013	uint RWE
<b>End</b> End	<b>Step Type Parameters End Type</b> When Step Type is End, this specifies what the controller will do when this profile ends.	<b>OFF</b> Control Mode set to Off (62) <b>Hold</b> Hold last closed-loop set point in the profile (47) <b>USER</b> User, reverts to previous set point (100)	Off	<b>Instance 1</b> Map 1 Map 2 2596 4526  Offset to next in-stance (Map 1 equals +50, Map 2 equals +100)	0x79 (121) 1 to 40 0xE (14)	21014	uint RWE

**Note:**

Some values will be rounded off to fit in the four-character display. Full values can be read with other interfaces.

\*\* R: Read, W: Write, E: EEPROM, S: User Set

Profiling Page

Display	Parameter Name Description	Range	Default	Modbus Relative Address	CIP Class Instance Attribute hex (dec)	Parameter ID	Data Type and Access **
<i>Ent 1</i> Ent1	<b>Step Type Parameters Event 1</b> When Step Type is not Unused Step, select whether Event Output 1 or 2 is on or off during this step.	<i>oFF</i> Off (62) <i>oN</i> On (63)	Off	Instance 1 Map 1 Map 2 2582 4512  Offset to next instance (Map 1 equals +50, Map 2 equals +100)	0x79 (121) 1 to 40 7	21007	uint RWE
<i>Ent 2</i> Ent2	<b>Step Type Parameters Event 2</b> When Step Type is not Unused Step, select whether Event Output 1 or 2 is on or off during this step.	<i>oFF</i> Off (62) <i>oN</i> On (63)	Off	<b>Instance 1</b> Map 1 Map 2 2584 4514  Offset to next instance (Map 1 equals +50, Map 2 equals +100)	0x79 (121) 1 to 40 8	21008	uint RWE

**Note:**

Some values will be rounded off to fit in the four-character display. Full values can be read with other interfaces.

\*\* R: Read, W: Write, E: EEPROM, S: User Set

Display	Step Type Description	Parameters in Step Type
<i>UStP</i> UStP	<b>Step Types Unused Step</b> This is an empty step that can be used to plan for future steps to be inserted or temporarily deactivate a step in a profile. Change step type back when the step should be active again.	- - - -
<i>ti</i> ti	<b>Step Types Time</b> If Ramping Type found in the Global Menu of the Setup Page is set for Time, the control loop will follow set point over the specified time. If two loops of control are present then they will both follow independent set points over the specified time. The state of up to 2 event outputs may be set or maintained.	<i>t95 1</i> Target Set Point Loop 1 <i>hoUr</i> Hours <i>mi</i> Minutes <i>SEC</i> Seconds <i>Ent 1</i> Event 1 <i>Ent 2</i> Event 2
<i>rAtE</i> rAtE	<b>Step Types Rate</b> If Ramping Type found in the Global Menu of the Setup Page is set for Rate, specify the rate of change in degrees or units per minute. The state of up to 2 event outputs may be set or maintained.	<i>t95 1</i> Target Set Point Loop 1 <i>rAtE</i> Rate <i>Ent 1</i> Event 1 <i>Ent 2</i> Event 2















Display	Step Type Description	Parameters in Step Type
<b>SoAH</b> SoAh	<b>Step Types</b> <b>Soak</b> A Soak Step maintains the last Target Set Points for the designated time. The state of up to 2 event outputs may be set or maintained.	<b>hoUr</b> Hours <b>miN</b> Minutes <b>SEC</b> Seconds <b>Ent 1</b> Event 1 <b>Ent 2</b> Event 2
<b>CLoC</b> CLoC	<b>Step Types</b> <b>Wait For Time</b> A Wait for Time Step is available with the real-time calendar clock feature. This allows the program to wait for a specified day and time before proceeding to the next step. Used to have the profile execute steps everyday or only weekdays. The state of up to 2 event outputs may be set or maintained.	<b>hoUr</b> Hours <b>miN</b> Minutes <b>SEC</b> Seconds <b>doWd</b> Day of Week <b>Ent 1</b> Event 1 <b>Ent 2</b> Event 2
<b>W.E</b> W.E	<b>Step Types</b> <b>Wait For Event</b> A Wait for Event Step will wait for the two Wait for Event states (1 to 2) to match the specified state. The state of up to 2 event outputs may be set or maintained.	<b>W.E.1</b> Wait Event 1 <b>W.E.2</b> Wait Event 2 <b>Ent 1</b> Event 1 <b>Ent 2</b> Event 2
<b>W.Pr</b> W.Pr	<b>Step Types</b> <b>Wait For Process</b> A Wait for Process Step will wait for Process Value 1 or 2 to match the Wait for Process Value. The state of up to 2 event outputs may be set or maintained.	<b>W.P.1</b> Wait for Process Instance <b>W.P.1</b> Wait for Process 1 Value <b>Ent 1</b> Event 1 <b>Ent 2</b> Event 2
<b>W.bo</b> W.bo	<b>Step Types</b> <b>Wait For Both</b> A Wait For Process and Event Step will wait for Process Value 1 or 2 to match the Wait for Process 1 value, and/or the two Wait Event states to match the specified state. The state of up to 2 event outputs may be set or maintained.	<b>W.P.1</b> Wait for Process Instance <b>W.P.1</b> Wait for Process 1 Value <b>W.E.1</b> Wait Event 1 <b>W.E.2</b> Wait Event 2 <b>Ent 1</b> Event 1 <b>Ent 2</b> Event 2
<b>JL</b> JL	<b>Step Types</b> <b>Jump</b> A Jump step will repeat previous steps a number of times designated in Jump Count. Jumps can be nested up to four deep. The state of up to 2 event outputs may be set or maintained.	<b>JS</b> Jump Step <b>JC</b> Jump Count <b>Ent 1</b> Event 1 <b>Ent 2</b> Event 2
<b>End</b> End	<b>Step Types</b> <b>End</b> An End Step will end the profile and set the control modes and set points to match the End Type. The state of up to 2 event outputs may be set or maintained. The event outputs will not be set off unless specifically stated in this step. If a profile does not have an End Step, the profile continues until step 40, then stops and maintains the last set points and control modes.	<b>End</b> End Type <b>Ent 1</b> Event 1 <b>Ent 2</b> Event 2

# 8

## Chapter 8: Factory Page

### Navigating the Factory Page

To navigate to the Factory Page follow the steps below:

1. From the Home Page, press and hold both the Advance  and Infinity  keys for six seconds.
2. Press the Up  or Down  key to view available menus.
3. Press the Advance Key  to enter the menu of choice.
4. If a submenu exists (more than one instance), press the Up  or Down  key to select and then press the Advance Key  to enter.
5. Press the Up  or Down  key to move through available menu prompts.
6. Press the Infinity Key  to move backwards through the levels: parameter to submenu, submenu to menu, menu to Home Page.
7. Press and hold the Infinity Key  for two seconds to return to the Home Page.

On the following pages, top level menus are identified with a yellow background color.

#### Note:

Some of these menus and parameters may not appear, depending on the controller's options. See model number information in the Appendix for more information. If there is only one instance of a menu, no submenus will appear.

#### Note:

Some of the listed parameters may not be visible. Parameter visibility is dependent upon controller part number.

#### CUST

##### FCTY Custom Setup Menu

- 1 CUST Custom Setup (1 to 20)
- PAR Parameter
- IID Instance ID

#### LoC

##### FCTY Security Setting Menu

- LoCo Operations Page
- LoCP Profiling Page
- PASE Password Enabled
- rLoC Read Lock
- SLoC Write Security
- LoCL Locked Access Level
- roLL Rolling Password
- PRSu User Password

#### PASR Administrator Password

#### ULoC

##### FCTY Security Setting Menu

- CoDE Public Key
- PA55 Password

#### dIAG

##### FCTY Diagnostics Menu

- Pn Part Number
- rEu Software Revision
- SbLd Software Build Number
- Sn Serial Number
- dATE Date of Manufacture

#### CAL

##### FCTY Calibration Menu

- 1 CAL Calibration (1 to 2)
- PAu Electrical Measurement
- ELio Electrical Input Offset
- ELiS Electrical Input Slope
- ELoo Electrical Output Offset
- ELoS Electrical Output Slope
- Pn Part Number
- CoDE Code

## Factory Page

Display	Parameter Name Description	Range	Default	Modbus Relative Address	CIP Class Instance Attribute hex (dec)	Pro-fibus Index	Parameter ID	Data Type and Access **
<b>CuSt</b> <b>Fcty</b> <b>Custom</b>								
<b>PAR</b> Par	<p><b>Custom Parameter 1 to 20</b></p> <p>Select the parameters that will appear in the Home Page.</p> <p>The Parameter 1 value will appear in the upper display of the Home Page. It cannot be changed with the Up and Down Keys in the Home Page.</p> <p>The Parameter 2 value will appear in the lower display in the Home Page. It can be changed with the Up and Down Keys, if the parameter is a writable one.</p> <p>Scroll through the other Home Page parameters with the Advance Key .</p> <p><b>Note:</b> Display Pairs affect the pairing of custom parameters on the Home page. For more information on Display Pairs see the section in this guide entitled "Modifying the Display Pairs".</p>	<p><i>none</i> None</p> <p><i>Proc</i> Process</p> <p><i>oCA</i> Calibration Offset</p> <p><i>C_UF</i> Display Units</p> <p><i>USrrr</i> Restore Settings From</p> <p><i>RLo</i> Low Set Point</p> <p><i>Rhi</i> High Set Point</p> <p><i>RhY</i> Hysteresis</p> <p><i>SetPt</i> Set Point</p> <p><i>ACPw</i> Active Process Value</p> <p><i>ACSP</i> Active Set Point</p> <p><i>oP</i> Manual Power</p> <p><i>Aut</i> Autotune</p> <p><i>CPM</i> Control Mode</p> <p><i>hPr</i> Heat Power</p> <p><i>CPc</i> Cool Power</p> <p><i>t_i</i> Time Integral</p> <p><i>t_d</i> Time Derivative</p> <p><i>db</i> Dead Band</p> <p><i>hPb</i> Heat Proportional Band</p> <p><i>hhY</i> On/Off Heat Hysteresis</p> <p><i>CPb</i> Cool Proportional Band</p> <p><i>ChY</i> On/Off Cool Hysteresis</p> <p><i>r_rk</i> Ramp Rate</p> <p><i>t_tUn</i> TRU-TUNE+® Enable</p> <p><i>idLE</i> Idle Set Point</p> <p><i>PSt_r</i> Profile Start</p> <p><i>PAC_r</i> Profile Action Request</p> <p><i>StP</i> Current Step</p> <p><i>StYP</i> Step Type</p> <p><i>t.SP!</i> Target Set Point</p> <p><i>hoUr</i> Hours</p> <p><i>PM in</i> Minutes</p> <p><i>SEC</i> Seconds</p> <p><i>gSd!</i> Guaranteed Soak Deviation 1</p> <p><i>Ent!</i> Event 1</p> <p><i>Ent2</i> Event 2</p> <p><i>JC</i> Jump Count Remaining</p> <p><i>CuSt</i> Custom Menu</p>	See: Home Page	- - - -	- - - -	- - - -	14005	uint RWES

\*\* R: Read, W: Write, E: EEPROM, S: User Set

## Factory Page

Display	Parameter Name Description	Range	Default	Modbus Relative Address	CIP Class Instance Attribute hex (dec)	Pro-fibus Index	Parameter ID	Data Type and Access **
<i>iid</i> iid	<i>Custom (1 to 20)</i> <b>Instance ID</b> Select which instance of the parameter will be selected.	1 to 4		-----	-----	-----	14003	uint RWES
<i>LoC</i> <i>FCTY</i> <b>Lock Menu</b>								
<i>LoC.o</i> LoC.o	<i>Security Setting</i> <b>Operations Page</b> Change the security level of the Operations Page.	1 to 3	2	<i>Instance 1</i> Map 1    Map 2 1832    2302	0x67 (103) 1 2	-----	3002	uint RWE
<i>LoC.P</i> LoC.P	<i>Security Setting</i> <b>Profiling Page</b> Change the security level of the Profiling Page.	1 to 3	3	<i>Instance 1</i> Map 1    Map 2 1844    2314	0x67 (103) 1 8	-----	3008	uint RWE
<i>PASE</i> LoC.P	<i>Security Setting</i> <b>Password Enable</b> Set to On to require a password for menu changes.	<i>oFF</i> Off <i>oN</i> On	Off	-----	-----	-----	3009	uint RWE
** R: Read, W: Write, E: EEPROM, S: User Set								

## Factory Page

Display	Parameter Name Description	Range	Default	Modbus Relative Ad- dress	CIP Class Instance Attribute hex (dec)	Pro- fibus Index	Param- eter ID	Data Type and Access **
rLoC rLoC	<b>Security Setting Read Lock</b> Set the read security clearance level. The user can access the selected level and all lower levels. If the Set Lockout Security level is higher than the Read Lockout Security, the Read Lockout Security level takes priority.	1 to 5	5	<i>Instance 1</i> Map 1    Map 2 1848    2318	0x67 (103) 1 0x0A (10)	- - - -	3010	uint RWE
SLoC SLoC	<b>Security Setting Write Security</b> Set the write security clearance level. The user can access the selected level and all lower levels. If the Set Lockout Security level is higher than the Read Lockout Security, the Read Lockout Security level takes priority.	0 to 5	5	<i>Instance 1</i> Map 1    Map 2 1844    2314	0x67 (103) 1 0x0B (11)	- - - -	3011	uint RWE
LoC.L LoC.L	<b>Security Setting Locked Access Level</b> Determines user level menu visibility when Password Enable is set to on. See Features section under Password Security.	1 to 5	5	- - - -	- - - -	- - - -	3016	uint RWE

\*\* R: Read, W: Write, E: EEPROM, S: User Set

## Factory Page

Display	Parameter Name Description	Range	Default	Modbus Relative Address	CIP Class Instance Attribute hex (dec)	Pro-fibus Index	Parameter ID	Data Type and Access **
<i>roLL</i> roLL	<i>Security Setting</i> <b>Rolling Password</b> When power is cycled a new Public Key will be displayed and User Password changes.	<i>oFF</i> Off <i>oN</i> On	Off	----	----	----	3019	uint RWE
<i>PAS.u</i> PAS.u	<i>Security Setting</i> <b>User Password</b> Used to acquire access to menus made available through the Locked Access Level setting.	10 to 999	63	----	----	----	3017	uint RWE
<i>PAS.A</i> PAS.A	<i>Security Setting</i> <b>Administrator Password</b> Used to acquire full access to all menus including disabling or changing passwords.	10 to 999	156	----	----	----	3018	uint RWE
<i>ULoC</i> <i>FCtY</i> <b>Unlock Menu</b>								
<i>CodE</i> CodE	<i>Security Setting</i> <b>Public Key</b> If Rolling Password turned on, generates a random number when power is cycled. If Rolling Password is off fixed number will be displayed. The key can be used to gain access when password is not known.	Customer Specific	0	----	----	----	3020	uint R

\*\* R: Read, W: Write, E: EEPROM, S: User Set

## Factory Page

Display	Parameter Name Description	Range	Default	Modbus Relative Ad- dress	CIP Class Instance Attri- bute hex (dec)	Pro- fibus Index	Param- eter ID	Data Type and Access **
<b>PASS</b> PASS	<b>Security Setting Password</b> Enter the User or Administrator password to gain access. After valid password is supplied exit this menu and re-enter the Security Menu via the Factory Page.	-1999 to 9999	0	- - - -	- - - -	- - - -	3022	int RW

**d .A9**  
**FCLY**

### Diagnostics Menu

<b>Pn</b> Pn	<b>Diagnostics Part Number</b> Display this controller's part number.	15 characters	- - - -	- - - -	0x65 (101) 1 9	115	1009	string R
<b>rEu</b> rEu	<b>Diagnostics Software Revi- sion</b> Display this controller's firm- ware revision number.	1 to 10	- - - -	<b>Instance 1</b> Map 1 Map 2 4 4	0x65 (101) 1 3	116	1003	string R
<b>S.bLd</b> S.bLd	<b>Diagnostics Software Build Number</b> Display the firmware build number.	0 to 2,147,483,647	- - - -	<b>Instance 1</b> Map 1 Map 2 8 8	0x65 (101) 1 5	- - - -	1005	dint R
<b>Sn</b> Sn	<b>Diagnostics Serial Number</b> Display the se- rial number.	0 to 2,147,483,647	- - - -	<b>Instance 1</b> Map 1 Map 2 12 12	0x65 (101) 1 0x20 (32)	- - - -	1032	string R

\*\* R: Read, W: Write, E: EEPROM, S: User Set

## Factory Page

Display	Parameter Name Description	Range	Default	Modbus Relative Address	CIP Class Instance Attribute hex (dec)	Pro-fibus Index	Parameter ID	Data Type and Access **
dAtE	<i>Diagnostics</i> <b>Date of Manufacture</b> Display the date code (YYWW). Where YY = year and WW= week.	0 to 2,147,483,647	- - - -	<i>Instance 1</i> Map 1 Map 2 14 14	0x65 (101) 1 8	- - - -	1008	dint R
No Display	<i>Diagnostics</i> <b>Hardware ID</b> Display the Hardware ID.	0 to 2,147,483,647	- - - -	<i>Instance 1</i> Map 1 Map 2 0 0	0x65 (101) 1 1	- - - -	1001	dint R
No Display	<i>Diagnostics</i> <b>Firmware ID</b> Display the Firmware ID.	0 to 2,147,483,647	- - - -	<i>Instance 1</i> Map 1 Map 2 2 2	0x65 (101) 1 2	- - - -	1002	dint R

**CAL**  
**FCTY**

### Calibration Menu

Mv	<i>Calibration (1 to 2)</i> <b>Electrical Measurement</b> Read the raw electrical value for this input in the units corresponding to the Sensor Type (Setup Page, Analog Input Menu) setting.	-3.4e38 to 3.4e38		<i>Instance 1</i> Map 1 Map 2 400 400 <i>Instance 2</i> Map 1 Map 2 480 490	0x68 (104) 1 to 2 0x15 (21)	- - - -	4021	float R
----	---	-------------------	--	--	-----------------------------------	------------	------	------------

\*\* R: Read, W: Write, E: EEPROM, S: User Set



## Factory Page

Display	Parameter Name Description	Range	Default	Modbus Relative Address	CIP Class Instance Attribute hex (dec)	Pro-fibus Index	Parameter ID	Data Type and Access **
<i>EL<sub>1.0</sub></i> ELi.o	<i>Calibration (1 to 2)</i> <b>Electrical Input Offset</b> Change this value to calibrate the low end of the input range.	-1,999.000 to 9,999.000	0.0	<b>Instance 1</b> Map 1 Map 2 378 378 <b>Instance 2</b> Map 1 Map 2 458 468	0x68 (104) 1 to 2 0x0A (10)	-- --	4010	float RWES
<i>EL<sub>1.5</sub></i> ELi.S	<i>Calibration (1 to 2)</i> <b>Electrical Input Slope</b> Adjust this value to calibrate the slope of the input value.	-1,999.000 to 9,999.000	1.0	<b>Instance 1</b> Map 1 Map 2 380 380 <b>Instance 2</b> Map 1 Map 2 460 470	0x68 (104) 1 to 2 0xB (11)	-- --	4011	float RWES
<i>EL<sub>0.0</sub></i> ELo.o	<i>Calibration (1 or 3)</i> <b>Electrical Output Offset</b> Change this value to calibrate the low end of the output range.	-1,999.000 to 9,999.000	0.0	<b>Instance 1</b> Map 1 Map 2 728 848 <b>Instance 3</b> Map 1 Map 2 808 928	0x76 (118) 1 or 3 5	-- --	18005	float RWES
<i>EL<sub>0.5</sub></i> ELo.S	<i>Calibration (1 or 3)</i> <b>Electrical Output Slope</b> Adjust this value to calibrate the slope of the output value.	-1,999.000 to 9,999.000	1.0	<b>Instance 1</b> Map 1 Map 2 730 850 <b>Instance 3</b> Map 1 Map 2 810 930	0x76 (118) 1 or 3 6	-- --	18006	float RWES
<i>P<sub>n</sub></i> Pn	<i>Calibration (1 to 3)</i> <b>Part Number</b> Displays current setting for control model number.	<i>FCTY</i> Factory <i>USER</i> User	Factory	----	----	-- --	----	uint R

\*\* R: Read, W: Write, E: EEPROM, S: User Set

### Factory Page

Display	Parameter Name Description	Range	Default	Modbus Relative Address	CIP Class Instance Attribute hex (dec)	Pro-fibus Index	Parameter ID	Data Type and Access **
<i>Code</i> Code	<i>Calibration (1 to 3)</i> <b>Public Key</b> Changes the control to User or back to original model number as shown on the side of the control.	<i>250</i> User Settings <i>606</i> Factory model number	4999	- - - -	- - - -	- - - -	- - - -	uint RWES

\*\* R: Read, W: Write, E: EEPROM, S: User Set

# 9

## Chapter 9: Features

<b>Changing PM Integrated Model Number to PM Express . . . . .</b>	<b>121</b>
<b>Saving and Restoring Settings . . . . .</b>	<b>122</b>
<b>Programming the Home Page . . . . .</b>	<b>123</b>
<b>Tuning the PID Parameters. . . . .</b>	<b>123</b>
Autotune. . . . .	123
Manual Tuning . . . . .	124
Autotuning with TRU-TUNE+®. . . . .	125
<b>Inputs . . . . .</b>	<b>126</b>
Calibration Offset . . . . .	126
Calibration . . . . .	126
Filter Time Constant. . . . .	128
Sensor Selection . . . . .	128
Set Point Minimum and Maximum . . . . .	128
Scale High and Scale Low . . . . .	128
Range High and Range Low. . . . .	129
Ten Point Linearization. . . . .	129
<b>Outputs . . . . .</b>	<b>129</b>
Duplex . . . . .	129
NO-ARC Relay . . . . .	130
Retransmitting a Process Value or Set Point. . . . .	130
Cool Output Curve . . . . .	131
<b>Control Methods . . . . .</b>	<b>131</b>
Output Configuration . . . . .	131
Auto (closed loop) and Manual (open loop) Control . . . . .	132
On-Off Control . . . . .	133
Proportional and (P) Control . . . . .	133
Proportional and Integral (PI) Control . . . . .	134
Proportional, Integral and Derivative (PID) Control . . . . .	134
Dead Band . . . . .	134
Variable Time Base. . . . .	135
Single Set Point Ramping . . . . .	136
<b>Timer Function . . . . .</b>	<b>137</b>
Setting Up the Timer Function . . . . .	138
<b>Alarms. . . . .</b>	<b>140</b>
Process and Deviation Alarms . . . . .	140
Set Points. . . . .	140
Hysteresis . . . . .	140
Latching . . . . .	141
Silencing . . . . .	141

# 9

## Chapter 9: Features (cont.)

Blocking .....	141
Open Loop Detection .....	141
<b>Using Lockout and Password Security .....</b>	<b>142</b>
Using Lockout Method 2 (Password Enable) .....	144
<b>Modbus - Using Programmable Memory Blocks .....</b>	<b>146</b>
<b>Software Configuration .....</b>	<b>147</b>
Using EZ-ZONE Configurator Software .....	147

# Changing PM Integrated Model Number to PM Express



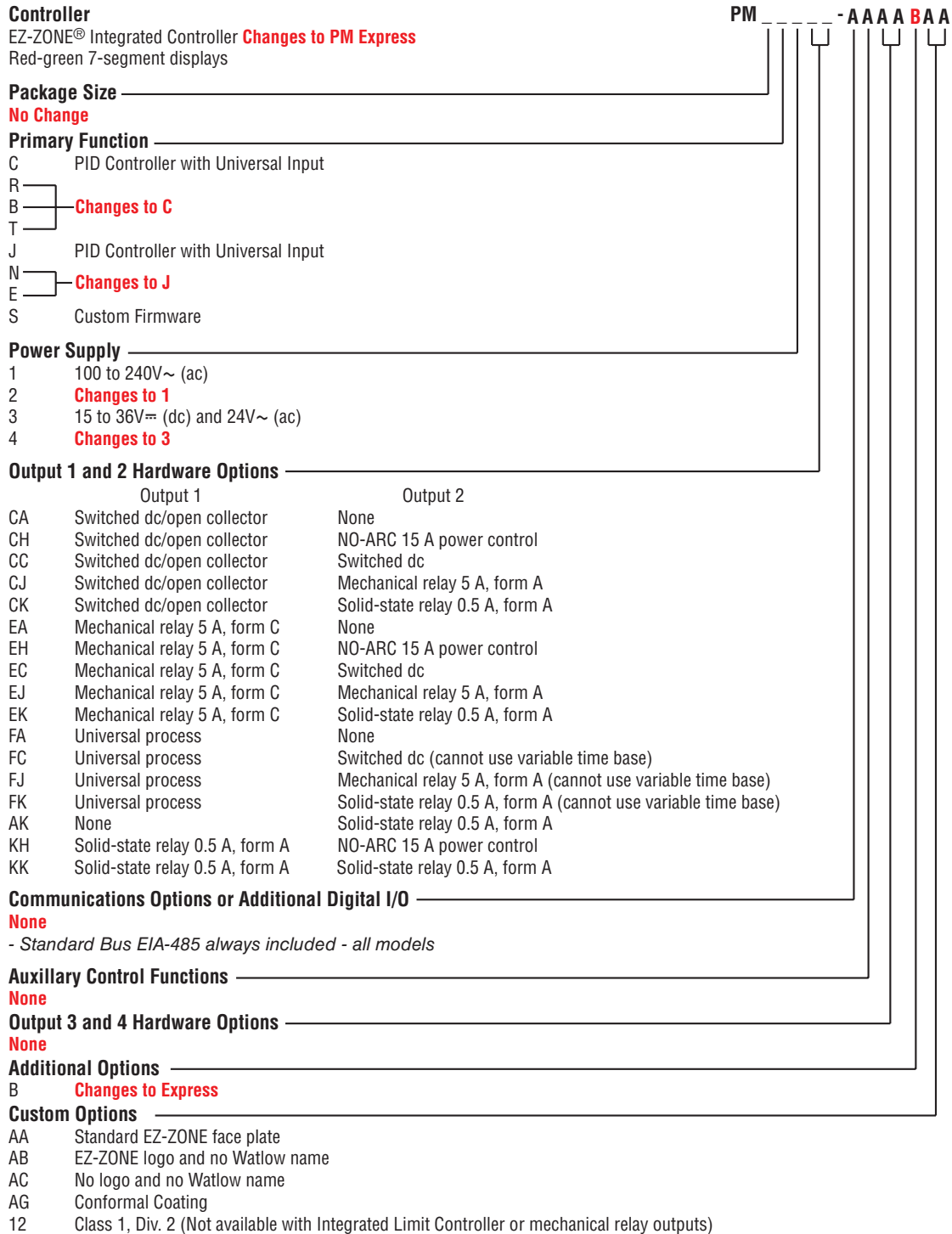

EZ-ZONE PM firmware revisions of 13 and above allow the user to switch between a PM Integrated control to a PM Express. Switching to a PM Express eliminates the complexity of the advanced PM Integrated control by allowing the user to operate with a simplified menu structure.

## Note:

When switching from an integrated control to an Express version, optional PM hardware (even though installed) and firmware features not available in a PM Express will no longer work. To see exactly what is impacted by this change, compare the chart below to the ordering information page in this document.



## How to Change the Controller Model Number

1. Enter Factory Page **FCTY**, Calibration Menu **CAL** via front panel by pressing the Infinity  or Reset Key and the Advance Key  together or using EZ-ZONE Configurator software.
2. Once there, use the Advance Key  to navigate to the Part Number **Pn** prompt. The top display will show factory **FCTY** indicating the factory model number as shown on the decal located on the side of the control is currently in effect.
3. Push the Advance Key , Public Key **Code** prompt will be displayed and the number **4999** in the top display.
4. Using the up or down Arrow Keys enter **2501** and push the Advance Key  to execute the change. The controller will reboot and the new controller model number is in effect. All previous settings are lost and the controller must be reprogrammed for the application. Be sure to label the controller with the new model number for future reference.

### Note:

As noted above, when switching from a PM Standard to a PM Express version, optional hardware (even though installed) may no longer work. Also, all settings will be defaulted to the selected model when switched.





### Note:

After switching the model number to a PM Express this document will no longer apply to the control. Click on the link that follows to acquire the latest version of the PM PID Express User's Guide.

Once there, simply enter express in the "Keyword" field to find the appropriate document.

---

## How to Restore Original PM Factory Settings and Model Number

1. Enter Factory Page **FCTY**, Calibration Menu **CAL** via front panel by pressing the Infinity  or Reset Key and the Advance Key  together or using EZ-ZONE Configurator software.
2. Once there, use the Advance Key  to navigate to the Part Number **Pn** prompt. The upper display will show user **USER** indicating the user's selected model number is currently in effect.
3. Push the Advance Key  where the Public Key **Code** prompt will appear in the lower display and the number **4999** in the upper display.
4. Using the up or down arrow keys enter **606** and push the Advance Key  to execute the change. The controller will reboot and the new controller model number is in effect. All previous settings are lost and the controller must be reprogrammed for the application. Be sure to label the controller with the new model number for future reference.

### Note:

When switching from a PM Express back to the original model number all original optional hardware will again be enabled for use (assuming all original hardware is still installed). Also, when executing this step the control will be factory defaulted back to the original model number (as shown on the side of the control) at zone address 1. This User's Guide would once again apply to this control.

---

## Saving and Restoring Settings

Recording setup and operations parameter settings for future reference is very important. If you unintentionally change these, you will need to program the correct settings back into the controller to return the equipment to operational condition.

After you program the controller and verify proper operation, select Save Settings As **U5r.5** (Setup Page, Global Menu) to save the settings into either of two files (**5E1** or **5E2**) in the control memory.

**Note:**

Saving the settings overwrites any previously saved collection of settings. Be sure to document all the controller settings.

If the settings in the controller are altered a user can return the controller to one of three settings. If previously saved, **5E1** or **5E2** can be restored as well as the factory **F11Y** settings. Navigate to the Setup Page, Global Menu to find the Restore **U5r.r** prompt. A digital input or the Function Key can also be configured to restore parameters.

**Note:**

When restoring factory defaults, I/O assemblies for Modbus, DeviceNet, Profibus and Ethernet along with the zone address will be overwritten when restoring factory defaults.

---

## Programming the Home Page

Watlow's patented user-defined menu system improves operational efficiency. The user-defined Home Page provides you with a shortcut to monitor or change the parameter values that you use most often.

You can create your own Home Page with as many as 20 of the active parameters. When a parameter normally located in the Setup Page or Operations Page is placed in the Home Page, it is accessible through both. If you change a parameter in the Home Page, it is automatically changed in its original page. If you change a parameter in its original page it is automatically changed in the Home Page.

The default parameters will automatically appear in the Home Page.

Change the list of parameters in the Home Page from the Custom Menu **CUS1** (Factory Page).

---

## Tuning the PID Parameters

### Autotune

When an autotune is performed on the EZ-ZONE® PM, the set point is used to calculate the tuning set point.

For example, if the active set point is 200° and Autotune Set Point **ALSP** (Operations Page, Loop Menu) is set to 90 percent, the autotune function utilizes 180° for tuning. This is also how autotuning works in previous Watlow controllers. In addition, changing the active set point in previous controllers causes the autotune function to restart; where with the EZ-ZONE PM changing the set point after an autotune has been started has no affect.

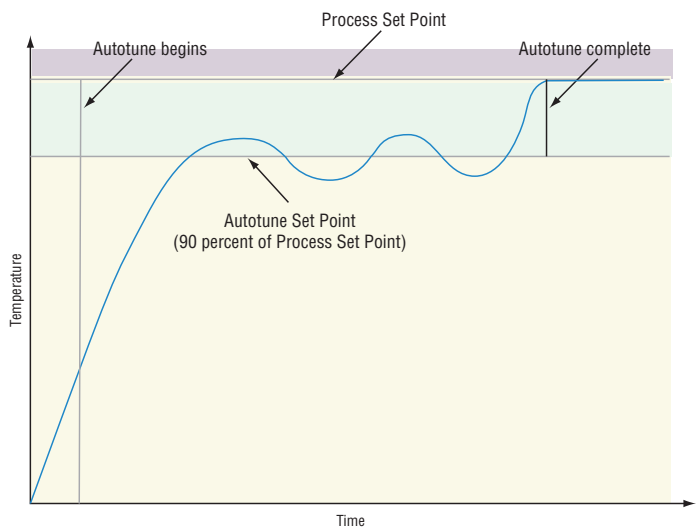

A new feature in EZ-ZONE PM products will allow set point changes while the control is autotuning, this includes while running a profile or ramping. When the auto tune is initially started it will use the current set point and will disregard all set point changes until the tuning

process is complete. Once complete, the controller will then use the new set point. This is why it is a good idea to enter the active set point before initiating an autotune.

Autotuning calculates the optimum heating and/or cooling PID parameter settings based on the system's response. Autotuning can be enabled whether or not TUNE-TUNE+® is enabled. The PID settings generated by the autotune will be used until the autotune feature is rerun, the PID values are manually adjusted or TRU-TUNE+ is enabled.

To initiate an autotune, set Autotune Request *Aut* (Operations Page, Loop Menu) to *YES*. You should not autotune while a profile is running. If the autotune cannot be completed in 60 minutes, the autotune will time-out and the original settings will take effect.

The upper display will flash *Auto* and the lower display will flash *Aut* while the autotuning is underway. The temperature must cross the Autotune Set Point five times to complete the autotuning process. Once complete, the controller controls

If you need to adjust the tuning procedure's aggressiveness, use Autotune Aggressiveness *Aut* (Setup Page, Loop Menu). Select Under Damped *Undr* to bring the process value to the set point quickly. Select over damped *over* to bring the process value to the set point with minimal overshoot. Select critical damped *Crit* to balance a rapid response with minimal overshoot.

---

## Manual Tuning

In some applications, the autotune process may not provide PID parameters for the process characteristics you desire. If that is the case, you may want to tune the controller manually.

1. Apply power to the controller and establish a set point typically used in your process.
2. Go to the Operations Page, Loop Menu, and set Heat Proportional Band *hPb* and/or Cool Proportional Band *Cpb* to 5. Set Time Integral *ti* to 0. Set Time Derivative *td* to 0.
3. When the system stabilizes, watch the process value. If it fluctuates, increase the Heat Proportional Band or Cool Proportional Band value in 3 to 5° increments until it stabilizes, allowing time for the system to settle between adjustments.
4. When the process has stabilized, watch Heat Power *hPr* or Cool Power *CPr* (Operations Page, Monitor Menu). It should be stable  $\pm 2\%$ . At this point, the process temperature should also be stable, but it will have stabilized before reaching the set point. The difference between the set point and actual process value can be eliminated with Integral.
5. Start with an Integral value of 6,000 and allow 10 minutes for the process temperature to reach the set point. If it has not, reduce the setting by half and wait another 10 minutes. Continue reducing the setting by half every 10 minutes until the process value equals the set point. If the process becomes unstable, the Integral value is too small. Increase the value until the process stabilizes.
6. Increase Derivative to 0.1. Then increase the set point by 11° to 17°C. Monitor the system's approach to the set point. If the process value overshoots the set point, increase Derivative to 0.2. Increase the set point by 11° to 17°C and watch the approach to the new set point. If you increase Derivative too much, the approach to the set point will be very sluggish. Repeat as necessary until the system rises to the new set point without overshoot or sluggishness.

For additional information about autotune and PID control, see related features in this chapter.



## Autotuning with TRU-TUNE+®

The TRU-TUNE+ adaptive algorithm will optimize the controller's PID values to improve control of dynamic processes. TRU-TUNE+ monitors the Process Value and adjusts the control parameters automatically to keep your process at set point during set point and load changes. When the controller is in the adaptive control mode, it determines the appropriate output signal and, over time, adjusts control parameters to optimize responsiveness and stability. The TRU-TUNE+ feature does not function for on-off control.

The preferred and quickest method for tuning a loop is to establish initial control settings and continue with the adaptive mode to fine tune the settings. Setting a controller's control mode to tune starts this two-step tuning process. (See Autotuning in this chapter.) This predictive tune determines initial, rough settings for the PID parameters. Then the loop automatically switches to the adaptive mode which fine tunes the PID parameters.

Once the Process Value has been at set point for a suitable period (about 30 minutes for a fast process to roughly two hours for a slower process) and if no further tuning of the PID parameters is desired or needed, TRU-TUNE+™ may be turned off. However, keeping the controller in the adaptive mode allows it to automatically adjust to load changes and compensate for differing control characteristics at various set points for processes that are not entirely linear.

Once the PID parameters have been set by the TRU-TUNE+ adaptive algorithm, the process, if shut down for any reason, can be restarted in the adaptive control mode. Turn TRU-TUNE+ on or off with TRU-TUNE+ Enable *ttun* (Setup Page, Loop Menu).

Use TRU-TUNE+ Band *tbnd* (Setup Page, Loop Menu) to set the range above and below the set point in which adaptive tuning will be active. Adjust this parameter only in the unlikely event that the controller is unable to stabilize at the set point with TRU-TUNE+ Band set to auto (0). This may occur with very fast processes. In that case, set TRU-TUNE+ Band to a large value, such as 100.

Use TRU-TUNE+ Gain *tgain* (Setup Page, Loop Menu) to adjust the responsiveness of the adaptive tuning calculations. Six settings range from 1, with the most aggressive response and most potential overshoot (highest gain), to 6, with the least aggressive response and least potential for overshoot (lowest gain). The default setting, 3, is recommended for loops with thermocouple feedback and moderate response and overshoot potential.

### Before Tuning

Before autotuning, the controller hardware must be installed correctly, and these basic configuration parameters must be set:

- Sensor Type *sen* (Setup Page, Analog Input Menu), and scaling, if required;
- Function *fn* (Setup Page, Output Menu) and scaling, if required.

### How to Autotune a Loop

1. Enter the desired set point or one that is in the middle of the expected range of set points that you want to tune for.
2. Initiate an autotune. (See Autotuning in this chapter.)

#### Note:

Enable TRU-TUNE+ only after autotune is complete. It should be disabled before autotune is initiated.

When autotuning is complete, the PID parameters should provide good control. As long as the loop is in the adaptive control mode, TRU-TUNE+ continuously tunes to provide the best possible PID control for the process.

**WARNING!** ⚠

*During autotuning, the controller sets the output to 100 percent and attempts to drive the Process Value toward the set point. Enter a set point and heat and cool power limits that are within the safe operating limits of your system.*

## Inputs

### Calibration Offset

Calibration offset allows a device to compensate for an inaccurate sensor, lead resistance or other factors that affect the input value. A positive offset increases the input value, and a negative offset decreases the input value. The input offset value can be viewed or changed with Calibration Offset  $\Delta R$  (Operations Page, Analog Input Menu).

### Calibration

Before performing any calibration procedure, verify that the displayed readings are not within published specifications by inputting a known value from a precision source to the analog input. Next, subtract the displayed value with the known value and compare this difference to the published accuracy range specification for that type of input.

Use of the Calibration Offset  $\Delta R$  parameter found in the Operations Page  $\Delta PER$ , Analog Input Menu  $R$ , shifts the readings across the entire displayed range by the offset value. Use this parameter to compensate for sensor error or sensor placement error. Typically this value is set to zero.

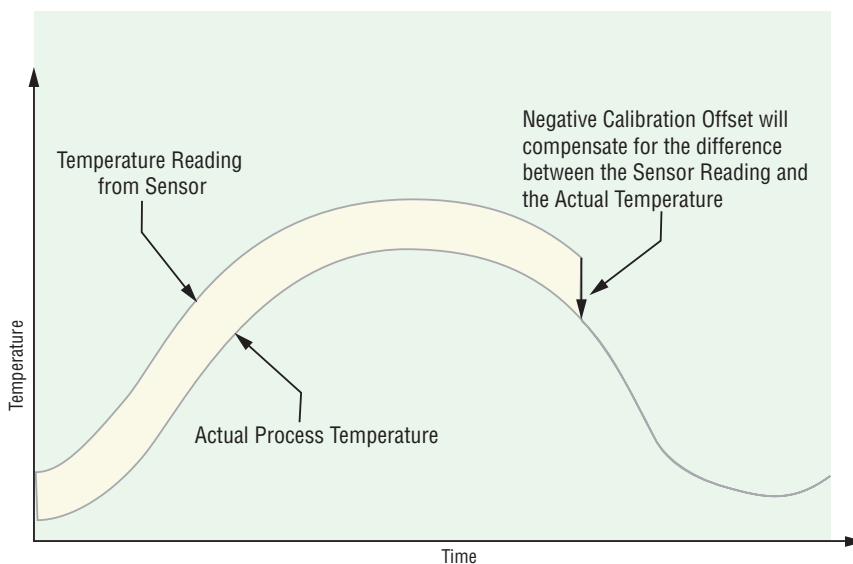

### Equipment required while performing calibration:

Obtain a precision source for millivolts, volts, milliamperes or resistance depending on the sensor type to be calibrated. Use copper wire only to connect the precision source to the controller's input. Keep leads between the precision source and controller as short as possible to minimize error. In addition, a precision volt/ohm meter capable of reading values to 4 decimal places or better is recommended. Prior to calibration, connect this volt/ohm meter to the precision source to verify accuracy. Actual input values do NOT have to be exactly the recommended values, but it IS critical that the actual value of the signal connected to the controller be accurately known to at least four digits.

## Calibration of Analog Inputs:

To calibrate an analog input, you will need to provide a source of two electrical signals or resistance values near the extremes of the range that the application is likely to utilize. See recommended values below:

Sensor Type	Precision Source Low	Precision Source High
thermocouple	0.000 mV	50.000 mV
millivolts	0.000 mV	50.000 mV
volts	0.000V	10.000V
milliamps	0.000 mA	20.000 mA
100 Ω RTD	50.00 Ω	350.0 Ω
1,000 Ω RTD	500.0 Ω	3,500 Ω
thermistor 5 kΩ	50.00	5,000
thermistor 10 kΩ	150.0	10,000
thermistor 20 kΩ	1,800	20,000
thermistor 40 kΩ	1,700	40,000
potentiometer	0.000	1,200

### Note:

The user may only calibrate one sensor type. If the calibrator interferes with open thermocouple detection, set Sensor Type  $SE_n$  in Setup Page  $SE_E$ , Analog Input Menu  $A_i$  to millivolt  $P7_u$  instead of Thermocouple  $EE$  to avoid interference between the calibrator and open thermocouple detect circuit for the duration of the calibration process. Be sure to set sensor type back to the thermocouple type utilized.

1. Disconnect the sensor from the controller.
2. Record the Calibration Offset  $CA$  parameter value in the Operations Page  $OPER$ , Analog Input Menu  $A_i$ , then set value to zero.
3. Wire the precision source to the appropriate controller input terminals to be calibrated. Do not have any other wires connected to the input terminals. Please refer to the Install and Wiring section of this manual for the appropriate connections.
4. Ensure the controller sensor type is programmed to the appropriate Sensor Type  $SE_n$  to be utilized in the Setup Page  $SE_E$ , Analog Input Menu  $A_i$ .
5. Enter Factory Page  $FCTY$ , Calibration Menu  $CAL$  via front panel or EZ-ZONE Configurator Software.
6. Select the Calibration  $CAL$  input instance to be calibrated. This corresponds to the analog input to be calibrated.
7. Set Electrical Input Slope  $EL_{i5}$  to 1.000 and Electrical Input Offset  $EL_{i0}$  to 0.000 (this will cancel any prior user calibration values)
8. Input a Precision Source Low value. Read Electrical Measurement value  $P7_u$  of controller via EZ-Configurator or RUI. This will be referred to as Electrical Measured Low. Record low value \_\_\_\_\_
9. Input a Precision Source High value.
10. Read Electrical Measurement value  $P7_u$  of controller via EZ-Configurator or RUI. This will be referred to as Electrical Measured High. Record high value \_\_\_\_\_
11. Calculated Electrical Input Slope = (Precision High - Precision Low) / (Electrical Measured High - Electrical Measured Low) Calculated Slope value \_\_\_\_\_

12. Calculated Electrical Input Offset = Precision Low - (Electrical Input Slope \* Measured Low) Calculated Offset value \_\_\_\_\_
  13. Enter the calculated Electrical Input Slope  $EL .5$  and Electrical Input Offset  $ELI .0$  into the controller.
  14. Exit calibration menu.
  15. Validate calibration process by utilizing a calibrator to the analog input.
  16. Enter calibration offset as recorded in step 2 if required to compensate for sensor error.
- Setting Electrical Input Slope  $EL .5$  to 1.000 and Electrical Input Offset  $ELI .0$  to 0.000, restores factory calibration as shipped from factory.

---

## Filter Time Constant

Filtering smooths an input signal by applying a first-order filter time constant to the signal. Filtering the displayed value makes it easier to monitor. Filtering the signal may improve the performance of PID control in a noisy or very dynamic system.

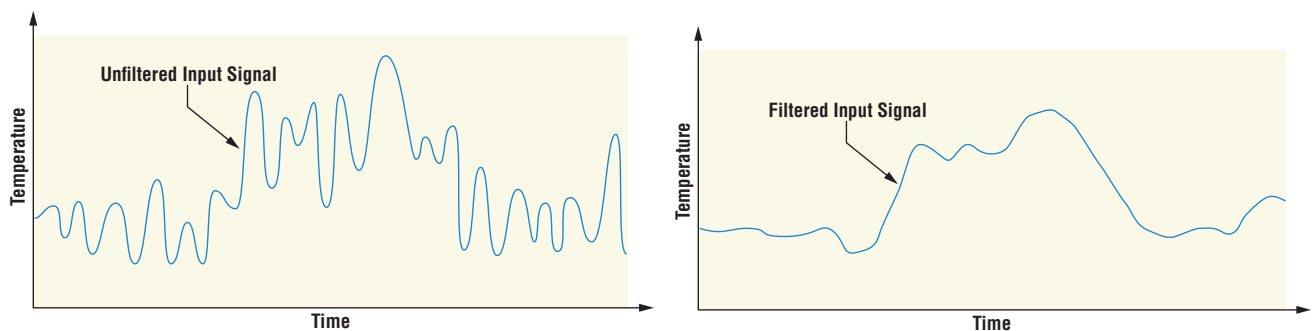

Adjust the filter time interval with Filter Time  $F .L$  (Setup Page, Analog Input Menu). Example: With a filter value of 0.5 seconds, if the process input value instantly changes from 0 to 100 and remained at 100, the display will indicate 100 after five time constants of the filter value or 2.5 seconds.

---

## Sensor Selection

You need to configure the controller to match the input device, which is normally a thermocouple, RTD or process transmitter.

Select the sensor type with Sensor Type  $SE n$  (Setup Page, Analog Input Menu).

---

## Set Point Minimum and Maximum

The controller has the ability to restrict the Set Points for the following modes of operation:

- a. For *closed loop control* use Minimum Set Point and Maximum Set Point found in the Setup Page, Loop Menu.
- b. For *Manual Power (open loop control)* use Minimum Power and Maximum Power found in the Setup Page, Loop Menu.

---

## Scale High and Scale Low

When an analog input is selected as process voltage or process current input, you must choose the value of voltage or current to be the low and high ends. For example, when using a 4 to 20 mA input, the scale low value would be 4.00 mA and the scale high value would be 20.00 mA. Commonly used scale ranges are: 0 to 20 mA, 4 to 20 mA, 0 to 5V, 1 to 5V and 0 to 10V.

You can create a scale range representing other units for special applications. You can reverse scales from high values to low values for analog input signals that have a reversed action. For example, if 50 psi causes a 4 mA signal and 10 psi causes a 20 mA signal.

Scale low and high low values do not have to match the bounds of the measurement range. These along with range low and high provide for process scaling and can include values not measurable by the controller. Regardless of scaling values, the measured value will be constrained by the electrical measurements of the hardware. Select the low and high values with Scale Low *S.L.O* and Scale High *S.h.i*. Select the displayed range with Range Low *r.L.O* and Range High *r.h.i* (Setup Page, Analog Input Menu).

---

## Range High and Range Low

With a process input, you must choose a value to represent the low and high ends of the current or voltage range. Choosing these values allows the controller's display to be scaled into the actual working units of measurement. For example, the analog input from a humidity transmitter could represent 0 to 100 percent relative humidity as a process signal of 4 to 20 mA. Low scale would be set to 0 to represent 4 mA and high scale set to 100 to represent 20 mA. The indication on the display would then represent percent humidity and range from 0 to 100 percent with an input of 4 to 20 mA. Select the low and high values with Range Low *r.L.O* and Range High *r.h.i* (Setup Page, Analog Input Menu).

---

## Ten Point Linearization

The linearization function allows a user to re-linearize a value read from an analog input. There are 10 data points used to compensate for differences between the sensor value read (input point) and the desired value (output point). Multiple data points enable compensation for non-linear differences between the sensor readings and target process values over the thermal or process system operating range. Sensor reading differences can be caused by sensor placement, tolerances, an inaccurate sensor or lead resistance.

The user specifies the unit of measurement and then each data point by entering an input point value and a corresponding output point value. Each data point must be incrementally higher than the previous point. The linearization function will interpolate data points linearly in between specified data points.

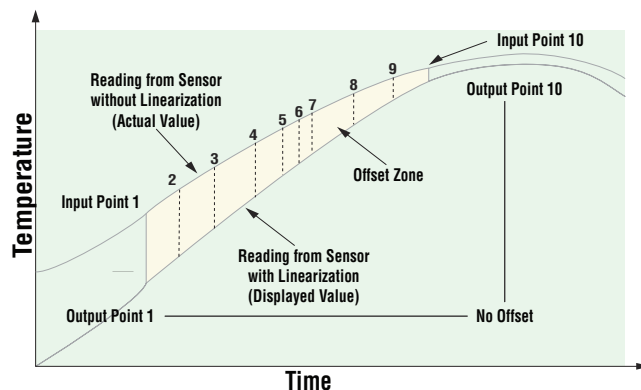

### Note:

Output Point 1 will be the minimum value that can be displayed, and Output Point 10 will be the maximum value that can be displayed. Consider setting Output Point 1 to the minimum operating range, and Output Point 10 to the maximum operating range; for that sensor type.

---

## Outputs

### Duplex

Certain systems require that a single process output, control both heating and cooling outputs. An EZ-ZONE® PM controller with a process output can function as two separate outputs.

With a 4 to 20mA output the heating output will operate from 12 to 20mA (0 to +100 percent) and the cooling output will operate from 12 to 4mA (0 to -100 percent).

In some cases this type of output is required by the device that the EZ-ZONE PM controls, such as a three-way valve that opens one way with a 12 to 20mA signal and opens the other way with a 4 to 12mA signal. This feature reduces the overall system cost by using a single output to act as two outputs.

Output 1 can be ordered as process output. Select duplex **DUPL** as the Output Function **F<sub>n</sub>** (Setup Page, Output Menu). Set the output to volts **VOLT** or milliamps **MA** with Type **OUT**. Set the range of the process output with Scale Low **SL** and Scale High **SH**.

---

## NO-ARC Relay

A NO-ARC relay provides a significant improvement in the life of the output relay over conventional relays. Conventional mechanical relays have an expected life of 100,000 cycles at the rated full-load current. The shorter life for conventional relays is due to the fact that when contacts open while current is flowing metal degradation occurs. This action produces unavoidable electrical arcing causing metal to transfer from one contact to the other. The arcing conditions continue on each subsequent contact opening until over time the resistance through the contacts increases causing the contacts to increase in temperature. Eventually, the contacts will weld together and the relay remains in the on state.

The Watlow NO-ARC relay is a hybrid relay. It uses a mechanical relay for the current load and a triac (solid-state switch) to carry the turn-on and turn-off currents. NO-ARC relays extend the life of the relay more than two million cycles at the rated full-load current.

Although a NO-ARC relay has significant life advantages, a few precautions must be followed for acceptable usage:

### Do not use:

- Hybrid relays for limit contactors. A limit or safety device must provide a positive mechanical break on all hot legs simultaneously
- DC loads with hybrid relays. The triacs used for arc suppression will turn off only with ac line voltage
- Hybrid switches to drive any inductive loads, such as relay coils, transformers or solenoids
- Cycle times less than five seconds on hybrid switches
- On loads that exceed 264V ac through relay
- On loads that exceed 15 amperes load
- On loads less than 100mA
- NO-ARC relays in series with other NO-ARC relays

---

## Retransmitting a Process Value or Set Point

The retransmit feature allows a process output to provide an analog signal that represents the set point or process value. The signal may serve as a remote set point for another controller or as an input for a chart recorder documenting system performance over time.

In choosing the type of retransmit signal the operator must take into account the input impedance of the device to be retransmitted to and the required signal type, either voltage or milliamps. Typically applications might use the retransmit option to record one of the variables with a chart recorder or to generate a set point for other controls in a multi-zone application.

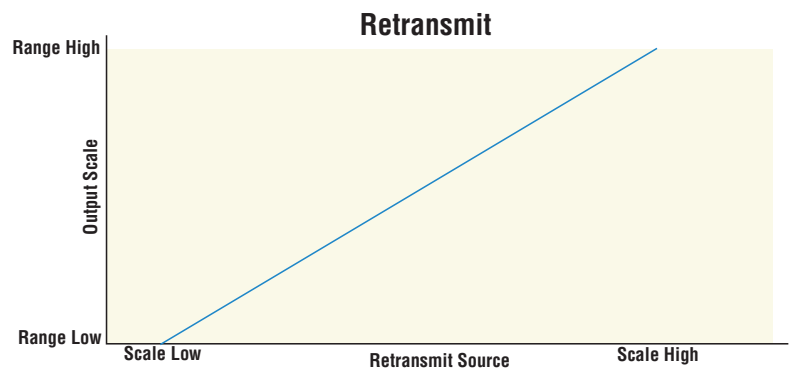

Output 1 can be ordered as process output. Select retransmit `r.r.t` as the Function `Fn` (Setup Page, Output Menu). Set the output to volts `v.o.l.t` or milliamps `m.a` with Type `a.t.y`. Select the signal to retransmit with Retransmit Source `r.s.r`. Set the range of the process output with Scale Low `s.l.o` and Scale High `s.h.i`. Scale the retransmit source to the process output with Range Low `r.l.o` and Range High `r.h.i`.

When the retransmit source is at the Range Low value, the retransmit output will be at its Scale Low value. When the retransmit source is at the Range High value, the retransmit output will be at its Scale High value.

## Cool Output Curve

A nonlinear output curve may improve performance when the response of the output device is nonlinear. If a cool output uses one of the nonlinear curves a PID calculation yields a lower actual output level than a linear output would provide.

These output curves are used in plastics extruder applications: curve A for oil-cooled extruders and curve B for water-cooled extruders. Select a nonlinear cool output curve with Cool Output Curve `c.c.r` (Setup Menu, Loop Menu).

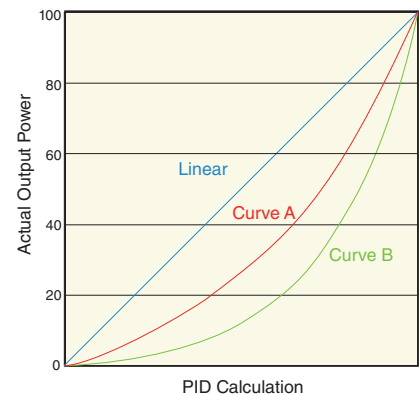

## Control Methods

### Output Configuration

Each controller output can be configured as a heat output, a cool output, an alarm output or deactivated. No dependency limitations have been placed on the available combinations. The outputs can be configured in any combination. For instance, all three could be set to cool.

Heat and cool outputs use the set point and Operations parameters to determine the output value. All heat and cool outputs use the same set point value. Heat and cool each have their own set of control parameters. All heat outputs use the same set of heat control parameters and all cool outputs use the same set of cool output parameters.

Each alarm output has its own set of configuration parameters and set points, allowing independent operation.

## Auto (closed loop) and Manual (open loop) Control

The controller has two basic modes of operation, auto mode and manual mode. Auto mode allows the controller to decide whether to perform closed-loop control or to follow the settings of Input Error Failure  $FEIL$  (Setup Page, Loop Menu). The manual mode only allows open-loop control. The EZ-ZONE® PM controller is normally used in the auto mode. The manual mode is usually only used for specialty applications or for troubleshooting.

Manual mode is open-loop control that allows the user to directly set the power level to the controller's output load. No adjustments of the output power level occur based on temperature or set point in this mode.

In auto mode, the controller monitors the input to determine if closed-loop control is possible. The controller checks to make certain a functioning sensor is providing a valid input signal. If a valid input signal is present, the controller will perform closed-loop control. Closed-loop control uses a process sensor to determine the difference between the process value and the set point. Then the controller applies power to a control output load to reduce that difference. If a valid input signal is not present, the controller will indicate an input error message in the upper display and  $FEIL$  in the lower display and respond to the failure according to the setting of Input Error Failure  $FEIL$ . You can configure the controller to perform a bumpless transfer  $BPLS$ , switch power to output a preset fixed level  $PRAN$ , or turn the output power off.

Bumpless transfer will allow the controller to transfer to the manual mode using the last

power value calculated in the auto mode if the process had stabilized at a  $\pm 5$  percent output power level for the time interval or 10 seconds, (whichever is longer) prior to sensor failure, and that power level is less than 75 percent. Reverse Bumpless functionality will take effect when the control is changed from Manual to Auto mode. The control will preload the Manual Power value into the Integral and Proportional Terms, which will allow for a bumpless transition. The normal PID action will then take over to control the output to the Set Point value.

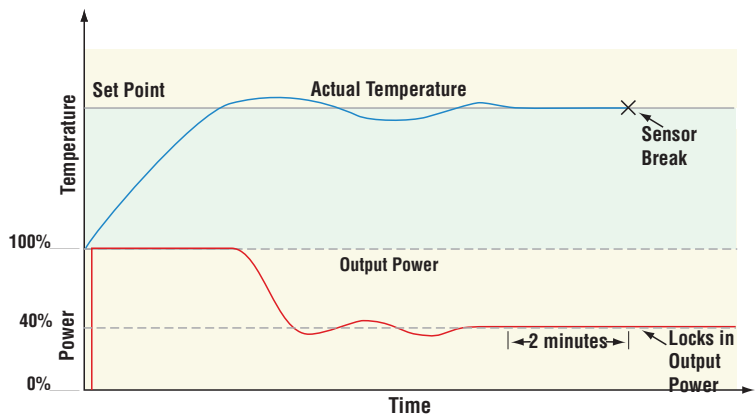

### Note:



Reverse bumpless ignores the transition from Off to Auto.

Input Error Latching  $IEL$  (Setup Page, Analog Input Menu) determines the controller's response once a valid input signal returns to the controller. If latching is on, then the controller will continue to indicate an input error until the error is cleared. To clear a latched alarm, press the Advance Key  $\odot$  then the Up Key  $\blacktriangle$ . If latching is off, the controller will automatically clear the input error and return to reading the temperature. If the controller was in the auto mode when the input error occurred, it will resume closed-loop control. If the controller was in manual mode when the error occurred, the controller will remain in open-loop control. The Manual Control Indicator Light % is on when the controller is operating in manual mode.



You can easily switch between modes if the Control Mode  $CPN$  parameter is selected to appear in the Home Page.





To transfer to manual mode from auto mode:

1. Press the Advance Key  until **LP7** appears in the lower display. The upper display will display **AUT** for auto mode.
2. Use the Up  or Down  keys to select **MAN**. The manual set point value will be recalled from the last manual operation.

To transfer to auto mode from manual mode:

1. Press the Advance Key  until **LP7** appears in the lower display. The upper display will display **MAN** for manual mode.
2. Use the Up  or Down  keys to select **AUT**. The automatic set point value will be recalled from the last automatic operation.

Changes take effect after three seconds or immediately upon pressing either the Advance Key  or the Infinity Key .

## On-Off Control

On-off control switches the output either full on or full off, depending on the input, set point and hysteresis values. The hysteresis value indicates the amount the process value must deviate from the set point to turn on the output. Increasing the value decreases the number of times the output will cycle. Decreasing hysteresis improves controllability. With hysteresis set to 0, the process value would stay closer to the set point, but the output would switch on and off more frequently, and may result in the output “chattering.” On-off control can be selected with Heat Algorithm **HAG** or Cool Algorithm **CAG** (Setup Page, Loop Menu). On-off hysteresis can be set with On/Off Heat Hysteresis **HHY** or On/Off Cool Hysteresis **CHY** (Operations Page, Loop Menu).

### Note:

Input Error Failure Mode **FRIL** does not function in on-off control mode. The output goes off.

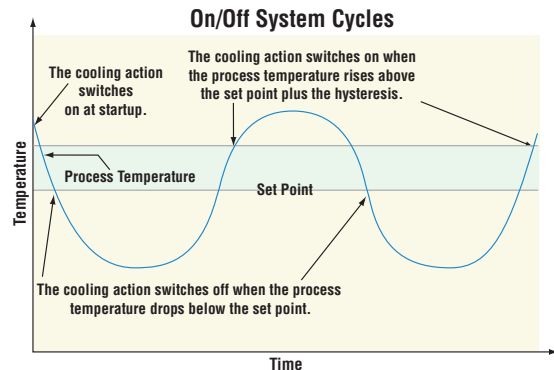
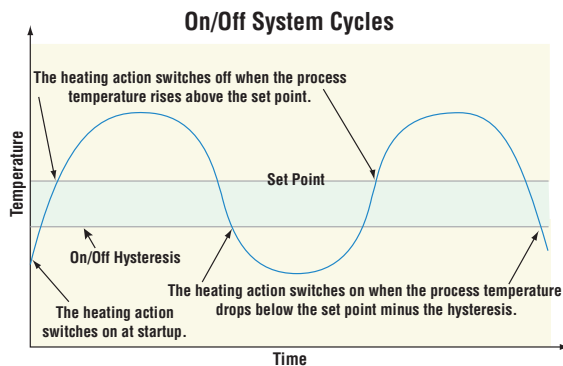

## Proportional and (P) Control

Some processes need to maintain a temperature or process value closer to the set point than on-off control can provide. Proportional control provides closer control by adjusting the output when the temperature or process value is within a proportional band. When the value is in the band, the controller adjusts the output based on how close the process value is to the set point. The closer the process value is to the set point, the lower the output power.

This is similar to backing off on the gas pedal of a car as you approach a stop sign. It keeps the temperature or process value from swinging as widely as it would with simple on-off control. However, when the system settles down, the temperature or process value tends to “droop” short of the set point.

With proportional control, the output power level equals the set point minus the process value divided by proportional band times 100. In an application with one output assigned to heating and another assigned to cooling, each will have a separate proportional parameter.

The heating parameter takes effect when

the process temperature is lower than the set point, and the cooling parameter takes effect when the process temperature is higher than the set point.

Adjust the proportional band with Heat Proportional Band  $h.Pb$  or Cool Proportional Band  $c.Pb$  (Operations Page, Loop Menu).

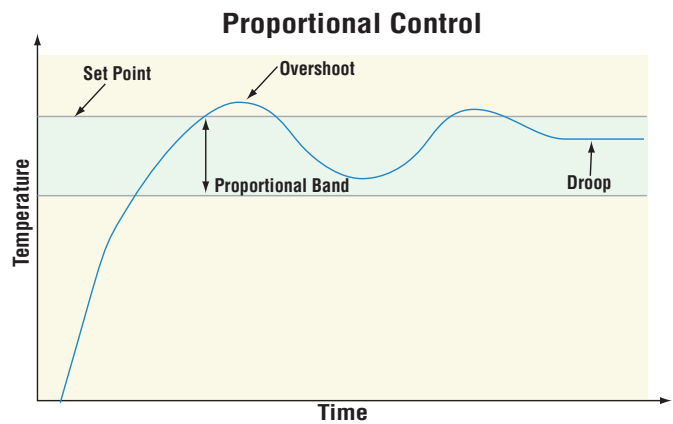

## Proportional and Integral (PI) Control

The droop caused by proportional control can be corrected by adding integral (reset) control. When the system settles down, the integral value is tuned to bring the temperature or process value closer to the set point. Integral determines the speed of the correction, but this may increase the overshoot at startup or when the set point is changed. Too much integral action will make the system unstable. Adjust the integral with Time Integral  $t_i$  (Operations Page, Loop Menu).

## Proportional, Integral and Derivative (PID) Control

Use derivative (rate) control to minimize the overshoot in a PI-controlled system. Derivative (rate) adjusts the output power immediately based on the rate of change in the temperature or process value. Too much derivative (rate) will make the system sluggish. Adjust the derivative with Time Derivative  $t_d$  (Operations Page, Loop Menu).

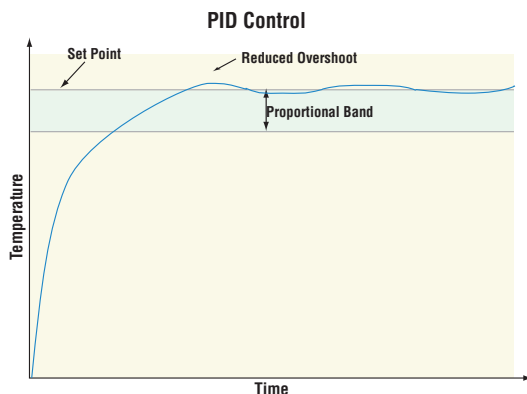

## Dead Band

In a PID application the dead bands above and below the set point can save an application’s energy and wear by maintaining process temperature within acceptable ranges.

Proportional action ceases when the process value is within the dead band. Integral action

continues to bring the process temperature to the set point. Using a **positive dead band value** keeps the two systems from fighting each other.

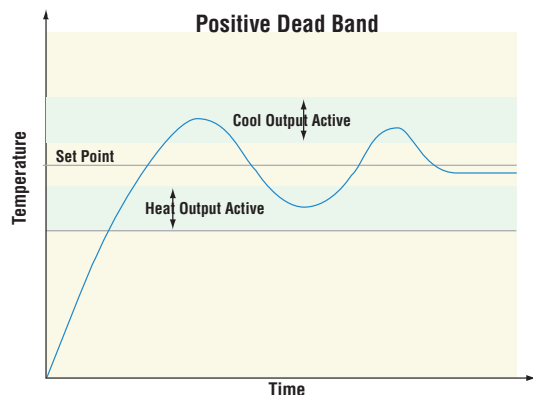

When the **dead band value is zero**, the heating output activates when the temperature drops below the set point, and the cooling output switches on when the temperature exceeds the set point.

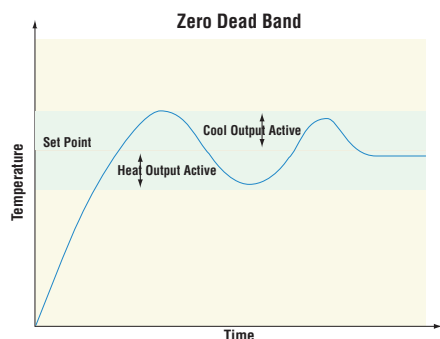

When the **dead band value is a negative value**, both heating and cooling outputs are active when the temperature is near the set point. Adjust the dead band with Dead Band  $db$  (Operations Page, Loop Menu).

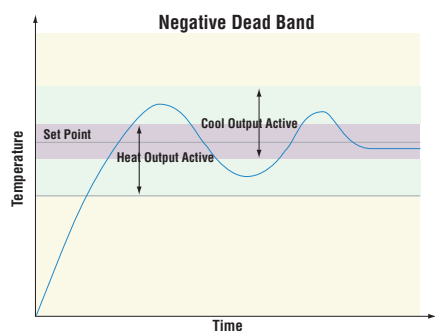

## Variable Time Base

Variable time base is the preferred method for controlling a resistive load, providing a very short time base for longer heater life. Unlike phase-angle firing, variable-time-base switching does not limit the current and voltage applied to the heater. With variable time base outputs, the PID algorithm calculates an output between 0 and 100%, but the output is distributed in groupings of three ac line cycles. For each group of three ac line cycles, the controller decides whether the power should be on or off. There is no fixed cycle time since the decision is made for each group of cycles. When used in conjunction with a zero cross (burst

fire) device, such as a solid-state power controller, switching is done only at the zero cross of the ac line, which helps reduce electrical noise (RFI). Variable time base should be used with solid-state power controllers, such as a solid-state relay (SSR) or silicon controlled rectifier (SCR) power controller. Do not use a variable time base output for controlling electromechanical relays, mercury displacement relays, inductive loads or heaters with unusual resistance characteristics.

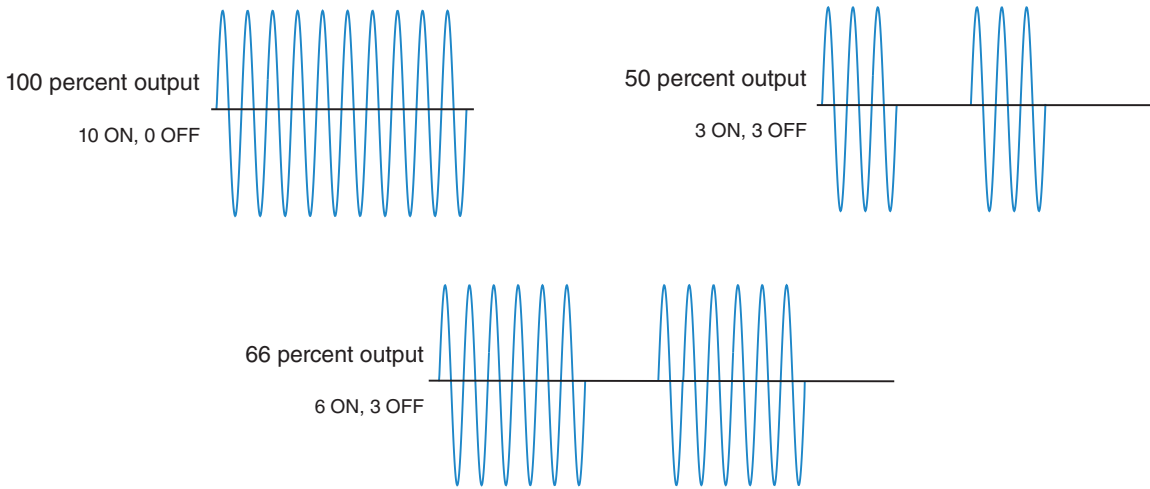

The combination of variable time base output and a solid-state relay can inexpensively approach the effect of analog, phase-angle fired control. Select the AC Line Frequency *ACLF* (Setup Page, Global Menu), 50 or 60 Hz.

## Single Set Point Ramping

Ramping protects materials and systems that cannot tolerate rapid temperature changes. The value of the ramp rate is the maximum degrees per minute or hour that the system temperature can change.

Select Ramp Action *rP* (Setup Page, Loop Menu):

- oFF* ramping not active.
- Stt* ramp at startup.
- StPt* ramp at a set point change.
- both* ramp at startup or when the set point changes.

Select whether the rate is in degrees per minute or degrees per hour with Ramp Scale *rSL*. Set the ramping rate with Ramp Rate *r.rL* (Setup Page, Loop Menu).

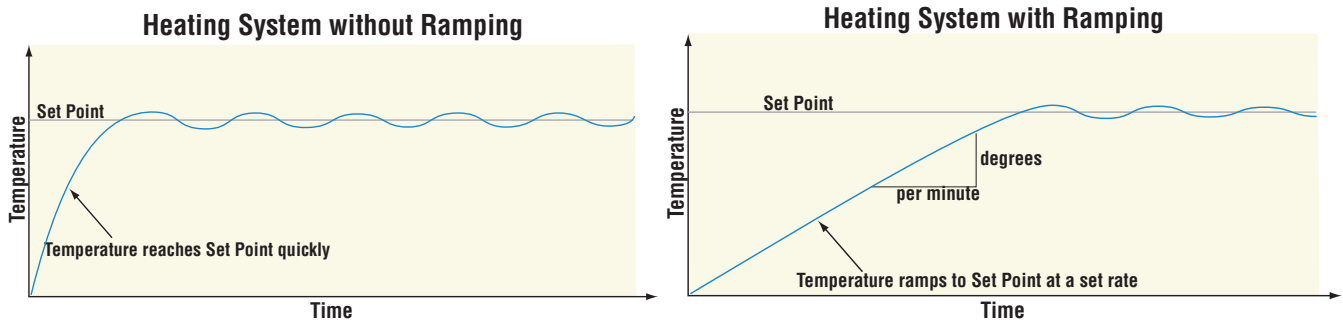

## Timer Function

























1. When Timer Enable  $t_{EN}$  is set to yes  $YES$  and the timer is started (you define which key combination this is), the controller will switch from Set Point  $CLSP1$  to Closed Loop Timer Set Point  $CLTS1$ . If the timer is interrupted, the timer is terminated and the time remaining is reset to its initial value.
2. When Timer Start Method  $t_{SM}$  is set to:
  - a. *Immediate*  $IMD$ , the timer starts as soon as the counter is initiated. When Time Remaining  $t_r1$  equals zero, the set point changes from Closed Loop Timer Set Point  $CLTS1$  back to Set Point  $CLSP1$ . A flashing colon  $00:00$  indicates that a countdown is in progress.
  - b. *Ready Band*  $RDY$ , the set point changes and when the temperature is within ready band, the ready band indicator  lights up and the countdown timer starts and continues as long as the temperature is within the ready band. When Time Remaining  $t_r1$  equals zero, the set point changes from Closed Loop Timer Set Point  $CLTS1$  back to Set Point  $CLSP1$ . A flashing colon  $00:00$  indicates that a countdown is in progress.
  - c. *Ready Acknowledge*  $RDYA$ , the set point changes, and when the temperature is within the ready band, the ready band indicator  lights up. The user must then acknowledge (you define which key combination for this) that the countdown timer should start and continue as long as the temperature is within the ready band. When Time Remaining  $t_r1$  equals zero, the set point changes from Closed Loop Timer Set Point  $CLTS1$  back to Set Point  $CLSP1$ . A flashing colon  $00:00$  indicates that a countdown is in progress.
  - d. *Power*  $PLUR$ , the timer starts when the controller is turned on. When Time Remaining  $t_r1$  equals zero, the set point changes from Closed Loop Timer Set Point  $CLTS1$  back to Set Point  $CLSP1$ . A flashing colon  $00:00$  indicates that a countdown is in progress.
3. In Setup Page, Output Menu, Output Function  $F_n$  can be assigned as Timer Event Output 1  $tEo1$ , Timer Event Output 2  $tEo2$  or Timer Event Output 3  $tEo3$ . Timer Event Output 1 is active during timing, Timer Event Output 2 is deactivated during timing and Timer Event Output 3 produces a pulse at the end of the timing sequence. These signals may be used to monitor timer activity. Process outputs may not be assigned to Timer Event Outputs.
4. The home display is customized in the Factory Page, Custom Menu. You may program the display to alternate between display pairs. See display pairs in the Setup Page, Global Menu. As an example, we could show the process temperature in the upper display and have the lower display alternate between the countdown time remaining and the active set point.

### Note:

The timer feature is only available for control loop 1 of two-loop controllers. Time is entered in hours, minutes and seconds. Countdown time will use the entered time but display the time remaining in either hh:mm or mm:ss format, based on your settings. The colon pulses in one-second intervals during a countdown, to indicate that timing is underway. Parameters that appear in the Home page have the number 1 at the end of the displayed parameter. As an example,  $hour$  in the Setup Page, Timer Menu will be displayed as  $hour1$  in the Home Page.

## Setting Up the Timer Function

1. Press and hold up ▲ and down ▼ arrow keys for 6 seconds to enter into the Setup Page *SEt*.
2. Up arrow ▲ to Timer Menu *tPPr*.
3. Advance ⌚ to Timer Enable *t iEn* to make selection using the up ▲ and down ▼ arrow keys to select from the options below:  
*YES* Yes  
*no* No
4. Advance ⌚ to Timer Start Method *t iSt* to select the method that will start the timer.
5. Use the up arrow ▲ to select from the options below:  
*iPPr* Immediate  
*r dY* Ready Band  
*r dYA* Ready Ack  
*PbPr* Power
6. Advance ⌚ to Source Function A *SFnA* to select which input will start/terminate the timer. Use the up arrow ▲ to select from the options below:  
*nonE* None  
*d io* Digital I/O  
*FUn* Function Key
7. Advance ⌚ to Source Instance A and use the up arrow ▲ to make a selection below:  
If Source Function A of previous step is set to None *nonE*:  
*1* Does not matter which number is here  
*5 iA* Source Instance A  
If Source Function A of previous step is set to Digital I/O *d io*:  
*5* Select 5 to 6  
*5 iA* Source Instance A  
If Source Function A of previous step is set to Function Key *FUn*:  
*1* EZ1 Key  
*2* EZ2 Key  
*6* Hold infinity key for 2 seconds  
*7* Infinity ∞ and Down arrow ▼  
*8* Infinity ∞ and Up arrow ▲  
*5 iA* Source Instance A
8. Advance ⌚ to Source Function C *SFnC* to select the analog source for the ready band. Use the up arrow ▲ to select from the options below:  
*Pu* Process Value  
*nonE* None  
*A i* Analog Input  
*Lnr* Linearization
9. Advance ⌚ and use the up arrow ▲ to make a selection below:  
*1* 1 or (2, if second instance of Source Function C)

10. Advance  to Source Function D *SFnD* to select which input will acknowledge the ready band. Use the up arrow  to select from the options below:
  - nOnE* None
  - dIo* Digital I/O
  - FUn* Function Key
11. Advance  to Source Instance D and use the up arrow  to make a selection below:
  - If Source Function A of previous step is set to None *nOnE*:
    - 1* Does not matter which number is here
    - 5 Id* Source Instance D
  - If Source Function A of previous step is set to Digital I/O *dIo*:
    - 5* Select 5 to 6
    - 5 Id* Source Instance D
  - If Source Function A of previous step is set to Function Key *FUn*:
    - 1* EZ1 Key
    - 2* EZ2 Key
    - 6* Hold infinity key for 2 seconds
    - 7* Infinity  and Down arrow 
    - 8* Infinity  and Up arrow 
    - 5 Id* Source Instance D
12. Advance  to Time Remaining *tR*, read only, display in hh:mm or mm:ss.
13. Advance  to Ready Band State *rbS*, read only, displayed as yes *YES* or no *no*.
14. Advance  to Ready Band *rdY* to enter the value for Ready Band using Up  or Down arrow .
15. Advance  to Time Format *tFor* to select the time format. Use the up arrow  to make selection below:
  - tHm* Time Hours:Minutes
  - tPmS* Time Minutes:Seconds
16. Advance  to Countdown Time to enter hours, minutes and seconds using the Up  or Down arrow .
  - hOUr* Hours, then Advance 
  - mIn* Minutes, then Advance 
  - SEc* Seconds
17. Advance  to Closed Loop Timer Set Point *tLSP* to enter the temperature during counting using the Up  or Down arrow .
18. Advance  to Signal Time *St* to enter time in seconds for Timer Event Output 3 *tEo3* to be active at end of countdown time.
19. Press and hold the Infinity  or Reset key for more than 2 seconds to go to Home Page.
20. See programming custom home page in factory page, custom menu to change the display parameters such as active process value, closed loop set point time, closed loop timer set point and time remaining as appropriate for the application.

## Alarms

Alarms are activated when the output level, process value or temperature leaves a defined range. A user can configure how and when an alarm is triggered, what action it takes and whether it turns off automatically when the alarm condition is over. Configure alarm outputs in the Setup Page before setting alarm set points. Alarms do not have to be assigned to an output. Alarms can be monitored and controlled through the front panel or by using software.

### Process and Deviation Alarms

A process alarm uses one or two absolute set points to define an alarm condition. A deviation alarm uses one or two set points that are defined relative to the set point used by the control loop. High and low alarm set points are calculated by adding or subtracting offset values from the set point used by the control loop. If the set point changes, the window defined by the alarm set points automatically moves with it. Select the type with Type *ALY* (Setup Page, Alarm Menu).

---

### Set Points

The high set point defines the process value or temperature that will trigger a high side alarm. The set point defines the temperature that will trigger a low side alarm. For deviation alarms, a negative set point represents a value below set point used by the control loop. A positive set point represents a value above the set point used by the control loop. View or change alarm set points with Low Set Point *ALo* and High Set Point *AHi* (Operations Page, Alarm Menu).

---

### Hysteresis

An alarm state is triggered when the process value reaches the high or low set point. Hysteresis defines how far the process must return into the normal operating range before the alarm can be cleared.

Hysteresis is a zone inside each alarm set point. This zone is defined by adding the hysteresis value to the low set point or subtracting the hysteresis value from the high set point. View or change hysteresis with Hysteresis *AHY* (Setup Page, Alarm Menu).

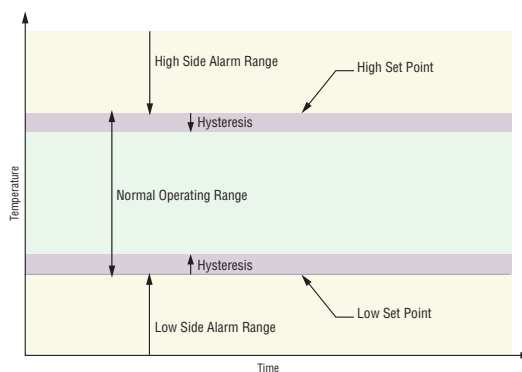

Alarm Set Points and Hysteresis



## Latching

A latched alarm will remain active after the alarm condition has passed. It can only be deactivated by the user. An active message, such as an alarm message, will cause the display to toggle between the normal settings and the active message in the upper display and **ALTN** in the lower display. Push the Advance Key **⏩** to display **9nr** in the upper display and the message source in the lower display. Use the Up **▲** or Down **▼** keys to scroll through possible responses, such as Clear **CLR** or Silence **SIL**. Then push the Advance **⏩** or Infinity **∞** key to execute the action.

See the Keys and Displays chapter and the Home Page chapter for more details. An alarm that is not latched (self-clearing) will deactivate automatically when the alarm condition has passed. Turn latching on or off with Latching **ALA** (Setup Page, Alarm Menu).

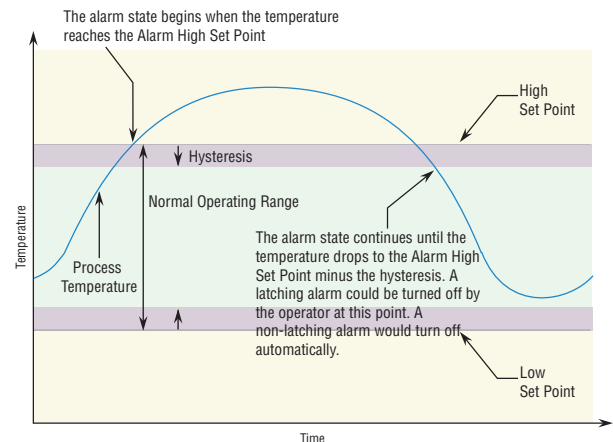

Alarm Response with Hysteresis

## Silencing

If silencing is on the operator can disable the alarm output while the controller is in an alarm state. The process value or temperature has to enter the normal operating range beyond the hysteresis zone to activate the alarm output function again. An active message, such as an alarm message, will cause the display to toggle between the normal settings and the active message in the upper display and **ALTN** in the lower display.

1. Push the Advance Key **⏩** to display **9nr** in the upper display and the message source in the lower display.
2. Use the Up **▲** and Down **▼** keys to scroll through possible responses, such as Clear **CLR** or Silence **SIL**. Then push the Advance **⏩** or Infinity **∞** key to execute the action.

See the Keys and Displays chapter and the Home Page chapter for more details. Turn silencing on or off with Silencing **AS** (Setup Page, Alarm Menu).

## Blocking

Blocking allows a system to warm up after it has been started up. With blocking on, an alarm is not triggered when the process temperature is initially lower than the low set point or higher than the high set point. The process temperature has to enter the normal operating range beyond the hysteresis zone to activate the alarm function. If the EZ-ZONE PM has an output that is functioning as a deviation alarm, the alarm is blocked when the set point is changed, until the process value re-enters the normal operating range. Turn blocking on or off with Blocking **ABL** (Setup Page, Alarm Menu).

## Open Loop Detection

When Open Loop Detection is enabled **LdE**, the controller will look for the power output to be at 100%. Once there, the control will then begin to monitor the Open Loop Detect Deviation **Ldd** as it relates to the value entered for the Open Loop Detect Time **Ldt**. If the specified time period expires and the deviation does not occur, an Open Loop Error will be triggered. Once the Open Loop Error condition exists the control mode will go off and an Open

Loop message will be display. If the process value goes in the opposite direction, a Reversed Loop message is display. The sensor is likely wired in reverse polarity.

**Note:**

All prompts identified in this section can be found in the Loop Menu of the Setup Page.

## Using Lockout and Password Security

If unintentional changes to parameter settings might raise safety concerns or lead to down-time, you can use the lockout feature to make them more secure. There are two methods of lockout that can be deployed, both of which are accessible from the Factory Page.

Method 1- Change the value of the Read Lock *rLoC* (1 to 5) and Set Lock *SLoC* (0 to 5) prompts where the higher the value or setting for each translates to a higher security clearance (greater access).

Method 2- Enable Password Security *PARSE* and then modify the Lock Level *LoEL* value which ranges from 1 to 5. See the section entitled [Using Lockout Method 2](#) for more detail.

### Using Lockout Method 1 (Read and Set Lock)

All Pages have security levels assigned where two of those cannot be changed (Home and Setup). Defaults (factory settings) for each are shown below:

- Home Page = 1
- Operations Page = 2 (changeable to 1, 2 or 3)
- Setup Page = 4
- Profiling Page = 3 (changeable to 1, 2 or 3)
- Factory Page = 5\*











\* The Factory Page is always visible where all menus within it may or may not be visible/writable. For further detail see table "[Factory Page Menus](#)".

The table below represents the various levels of lockout for the Set Lockout Security prompt *SLoC* and the Read Lockout Security prompt *rLoC*. Looking at the table, "Y" equates to yes (can write/read) where "N" equates to no (cannot write/read). The colored cells simply differentiate one level from the next while also showing the level where read/write is enabled. As stated previously, the Set Lockout has 6 levels (0 to 5) of security where the Read Lockout has 5 (1 to 5). Therefore, level "0" applies to Set Lockout only.

Lockout Security <i>SLoC</i> and <i>rLoC</i>						
Pages	Security Level					
	0	1	2	3	4	5
Home Page (cannot be changed)	N	Y	Y	Y	Y	Y
Operations Page	N	N	Y	Y	Y	Y
Setup Page (cannot be changed)	N	N	N	N	Y	Y
Profile Page	N	N	N	Y	Y	Y
Factory Page	Y	Y	Y	Y	Y	Y





Being able to change the page security level for the Operations and Profile pages allows a user to give access to the Profile Page while locking out the Operations Page. The following example shows how the Lockout feature may be used to accomplish this:

### Changing Security Levels:

1. From the Home Page, press and hold the Infinity Key  and the Advance Key  for approximately six seconds. **CUSE** will appear in the upper display and **FCEY** will appear in the lower display.
2. Press the Up Key  until **LoE** appears in the upper display and **FCEY** will appear in the lower display.
3. Press the Advance Key  until Lock Operations prompt **LoEo** appears in the bottom display.
4. Press the Up Key  to change the default value from **2** to **3**.
5. Press the Advance Key  again and change the Lock Profiling prompt **LoEP** appears in the bottom display.
6. Press the Down Key  to change the default value from **3** to **2**.
7. Press the Advance Key  until Read Lock **rLoE** appears in the bottom display.
8. Press the Down Key  to change the default value from **5** to **2**.
9. Press the Advance Key  until Set Lock **SLoE** appears in the bottom display.
10. Press the Down Key  to change the default value from **5** to **4**.

With the above settings, the Home Page and the Profiling Page can be accessed, and all writable parameters can be written to. Due to the Read lock setting of 2, all pages with security levels greater than 2 will be locked out (inaccessible).

Another example of Method 1 lockout usage could be that an operator wants read access to all pages while allowing read/write access to the Home Page and the Lockout Menu only. To setup this scenario follow the steps below:

1. From the Home Page, press and hold the Infinity Key  and the Advance Key  for approximately six seconds. **CUSE** will appear in the upper display and **FCEY** will appear in the lower display.
2. Press the Up Key  until **LoE** appears in the upper display and **FCEY** will appear in the lower display.
3. Press the Advance Key  until Read Lock **rLoE** appears in the bottom display and change it to **5**.
4. Press the Advance Key  until Set Lock **SLoE** appears in the bottom display and change it to **1**.

Although the Factory Page is always visible, some menus within it can be restricted.

Lockout Security <b>SLoE</b> and <b>rLoE</b>						
Factory Page Menus						
Menus	Security Level					
	0	1	2	3	4	5
Custom Menu	N	N	N	N	N	Y
Lockout Menu*	Y	Y	Y	Y	Y	Y
Diagnostic Menu**	N	Y	Y	Y	Y	Y
Calibration Menu	N	N	N	N	N	Y

- \* Using lockout Method 1 with *SLoC* set to 0, all writable parameters within the control will be inhibited (not writable) with two exceptions, *SLoC* and *rLoC*. As shown below, both of these parameters can always be seen and modified.
- \*\* Diagnostic Menu and all associated prompts are always visible and never writable

Lockout Security <i>SLoC</i> and <i>rLoC</i>						
Factory Page Menu Parameters						
Parameters	Security Level					
	0	1	2	3	4	5
<i>LoCo</i>	N	Y	Y	Y	Y	Y
<i>LoCP</i>	N	Y	Y	Y	Y	Y
<i>PA5E</i>	N	Y	Y	Y	Y	Y
<i>rLoC</i>	Y	Y	Y	Y	Y	Y
<i>SLoC</i>	Y	Y	Y	Y	Y	Y

**Note:**





Using Method 1 Lockout all settings can be modified by anyone who knows how to find their way to the *SLoC* and *rLoC* parameters.

### Using Lockout Method 2 (Password Enable)

It is sometimes desirable to apply a higher level of security to the control where a password would be required to access the control. If Password Enabled *PA5E* in the Factory Page under the *LoC* Menu is set to on, an overriding Password Security will be in effect. Without the appropriate password, specified menus will remain inaccessible. Page and Menu access is defined in the Locked Access Level *LoCL* prompt. On the other hand, a User with a password would have visibility restricted by the Read Lockout Security *rLoC*. As an example, with Password Enabled and the Locked Access Level *LoCL* set to 1 and *rLoC* is set to 3, the available Pages for a User without a password would be limited to the Home and Factory Pages (locked level 1). If the User password is entered all pages would be accessible with the exception of the Setup Page as defined by level 3 access.

### How to Enable Password Security

Follow the steps below:

1. From the Home Page, press and hold the Infinity Key  and the Advance Key  for approximately six seconds. *CuSt* will appear in the upper display and *FcTy* will appear in the lower display.
2. Press the Up Key  until *LoC* appears in the upper display and *FcTy* will appear in the lower display.
3. Press the Advance Key  until Password Enable *PA5E* appears in the bottom display and change it to *5*.
4. Press the Up Key  to turn it *on*. Once on, four new prompts will appear:
  - a. *Locked Access Level LoCL*, (1 to 5) corresponding to the lockout table above.
  - b. *Rolling Password rOLL*, will change the Customer Code every time power is cycled.
  - c. *User Password PA5u*, which is needed for a User to acquire access to the control.
  - d. *Administrator Password PA5A*, which is needed to acquire administrative access to the control.

The Administrator can either change the User and or the Administrator password or leave them in the default state. Once Password Security is enabled they will no longer be visible to anyone other than the Administrator. In other words the Lock Menu  $LoC$  is not available to a User. As can be seen in the formula that follows either the User or Administrator will need to know what those passwords are to acquire a higher level of access to the control. Back out of this menu by pushing the Infinity Key  $\infty$ . Once out of the menu, the Password Security will be enabled.

---

## How to Acquire Access to the Control

To acquire access to any inaccessible Pages or Menus, go to the Factory Page and enter the  $ULoC$  menu. Once there follow the steps below:

### Note:

If Password Security (Password Enabled  $PAS.E$  is On) is enabled the two prompts mentioned below in the first step will not be visible. If the password is unknown, call the individual or company that originally setup the control.

1. Acquire either the User Password  $PAS_u$  or the Administrator Password  $PAS_A$ .
2. Press the Advance  $\rightarrow$  key one time where the Code  $CoDE$  prompt will be visible.

### Note:

- a. If the Rolling Password is off, press the Advance Key  $\rightarrow$  one more time where the Password  $PASS$  prompt will be displayed. Proceed to either step 7a or 8a. Pushing the Up  $\uparrow$  or Down  $\downarrow$  arrow keys enter either the User or Administrator Password. Once entered, press and hold the Infinity  $\infty$  key for two seconds to return to the Home Page.
  - b. If the Rolling Password  $roLL$  was turned on proceed on through steps 3 - 9.
3. Assuming the Code  $CoDE$  prompt (Public Key) is still visible on the face of the control simply push the Advance Key  $\rightarrow$  to proceed to the Password  $PASS$  prompt. If not, find your way back to the Factory Page as described above.
  4. Execute the calculation defined below (7b or 8b) for either the User or Administrator.
  5. Enter the result of the calculation in the upper display play by using the Up  $\uparrow$  and Down  $\downarrow$  arrow keys or use EZ-ZONE Configurator Software.
  6. Exit the Factory Page by pressing and holding the Infinity Key  $\infty$  for two seconds.

Formulas used by the User and the Administrator to calculate the Password follows:

Passwords equal:

### 7. User

- a. If Rolling Password  $roLL$  is Off, Password  $PASS$  equals User Password  $PAS_u$ .
- b. If Rolling Password  $roLL$  is On, Password  $PASS$  equals:  $(PAS_u \times code) \text{ Mod } 929 + 70$

### 8. Administrator

- a. If Rolling Password  $roLL$  is Off, Password  $PASS$  equals User Password  $PAS_A$ .
- b. If Rolling Password  $roLL$  is On, Password  $PASS$  equals:  $(PAS_A \times code) \text{ Mod } 997 + 1000$

## Differences Between a User Without Password, User With Password and Administrator

- User **without** a password is restricted by the Locked Access Level  $LoCL$ .
- A User **with** a password is restricted by the Read Lockout Security  $rLoC$  never having access to the Lock Menu  $LoC$ .

- An Administrator is restricted according to the Read Lockout Security `rLoE` however, the Administrator has access to the Lock Menu where the Read Lockout can be changed.

---

## Modbus - Using Programmable Memory Blocks

When using the Modbus RTU or Modbus TCP protocols, the PM control features a block of addresses that can be configured by the user to provide direct access to a list of 40 user configured parameters. This allows the user easy access to this customized list by reading from or writing to a contiguous block of registers.

To acquire a better understanding of the tables found in the back of this manual (See Appendix: [Modbus Programmable Memory Blocks](#)) please read through the text below which defines the column headers used.

---

### Assembly Definition Addresses

- Fixed addresses used to define the parameter that will be stored in the "Working Addresses", which may also be referred to as a pointer. The value stored in these addresses will reflect (point to) the Modbus address of a parameter within the PM control.

---

### Assembly Working Addresses

- Fixed addresses directly related to their associated "Assembly Definition Addresses" (i.e., Assembly Working Addresses 200 & 201 will assume the parameter pointed to by Assembly Definition Addresses 40 & 41).

When the Modbus address of a target parameter is stored in an "Assembly Definition Address" its corresponding working address will return that parameter's actual value. If it's a writable parameter, writing to its working register will change the parameter's actual value. As an example, Modbus register 360 represents the Analog Input 1 Process Value (See Operations Page, Analog Input Menu). If the value 360 is loaded into Assembly Definition Address 90 and value 361 is loaded into Assembly Definition Address 91, the process value sensed by analog input 1 will also be stored in Modbus registers 250 and 251. Notice that by default this parameter is also stored in working registers 240 and 241 as well.

#### Note:

When modifying the Modbus Assembly registers, single register writes (function 06) are not allowed. Multiple register writes (function 16) must be used to modify the assembly.

The table identified as "Assembly Definition Addresses and Assembly Working Addresses" (see Appendix: Modbus Programmable Memory Blocks) reflects the assemblies and their associated addresses.

## Software Configuration

### Using EZ-ZONE Configurator Software

To enable a user to configure the PM control using a personal computer (PC), Watlow has provided free software for your use. If you have not yet obtained a copy of this software insert the CD (Controller Support Tools) into your CD drive and install the software. Alternatively, if you are viewing this document electronically and have a connection to the internet simply click on the link below and download the software from the Watlow web site free of charge.

Once the software is installed double click on the EZ-ZONE Configurator icon placed on your desktop during the installation process. If you cannot find the icon follow the steps below to run the software:

1. Move your mouse to the "Start" button
2. Place the mouse over "All Programs"
3. Navigate to the "Watlow" folder and then the sub-folder "EZ-ZONE Configurator"
4. Click on EZ-ZONE Configurator to run.

The first screen that will appear is shown below.



If the PC is already physically connected to the EZ-ZONE PM control click the next button to go on-line.

#### Note:

When establishing communications from PC to the EZ-ZONE PM control an interface converter will be required. The Standard Bus network uses EIA-485 as the interface. Most PCs today would require a USB to EIA-485 converter. However, some PCs may still be equipped with EIA-232 ports, therefore an EIA-232 to EIA-485 converter would be required.

As can be seen in the above screen shot the software provides the user with the option of downloading a previously saved configuration as well as the ability to create a configuration off-line to download later. The screen shots that follow will take the user on-line.

After clicking the next button above it is necessary to define the communications port that will be used on the PC as shown below. Clicking on the drop down will allow the user to select the appropriate communications port. This will be the port assigned to the EIA-485 to USB converter when it was connected to the PC. The "Advanced" button allows the user to determine how many devices to look for on the network (1 to 17).

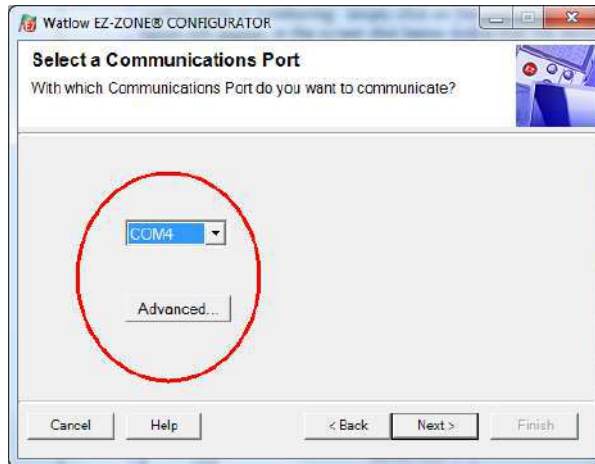

After clicking on the "Next" button, the software will scan the network for the zone addresses specified while showing the progress made (as shown in the graphic below. When complete the software will display all of the available devices found on the network as shown below.

### Searching Network for Devices

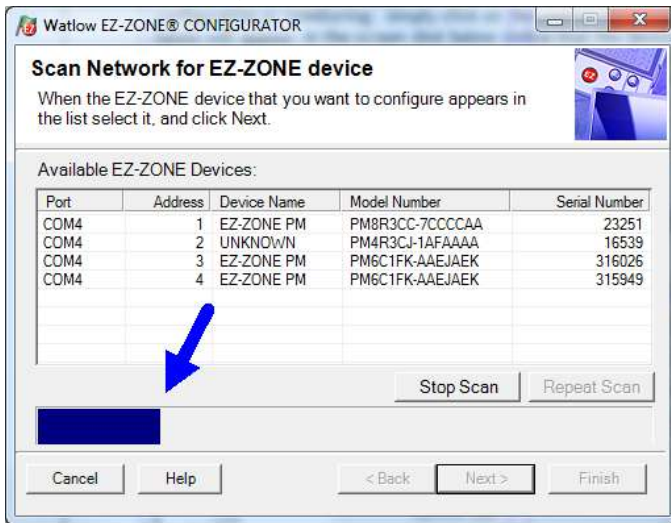

### Available Network Devices Displayed

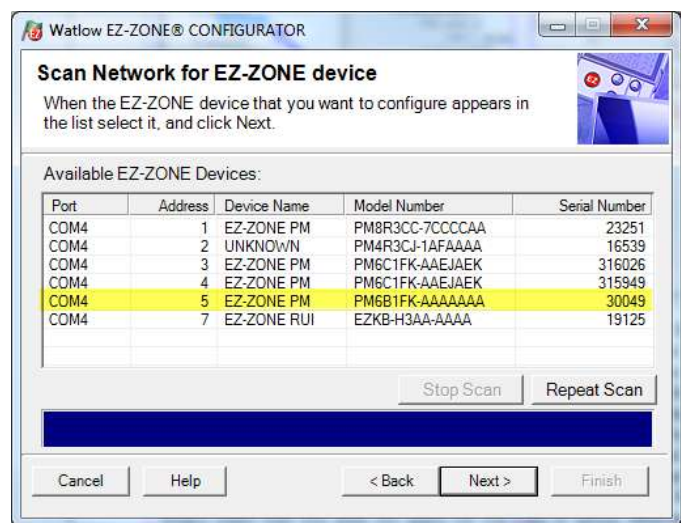

The PM8 is shown highlighted to bring greater clarity to the control in focus. Any EZ-ZONE device on the network will appear in this window and would be available for the purpose of configuration or monitoring; simply click on the control of choice. After doing so, the screen below will appear. In the screen shot below notice that the device part number is clearly displayed at the top of the page (yellow highlight added for emphasis). When multiple EZ-ZONE devices are on the network it is important that the part number be noted prior to configuring so as to avoid making unwanted configuration changes to another control. Looking closely at the left hand column (Parameter Menus) notice that it displays all of the available menus and associated parameters within the control.



The menu structure as laid out within this software follows:

- Setup - Operations - Factory - Profile

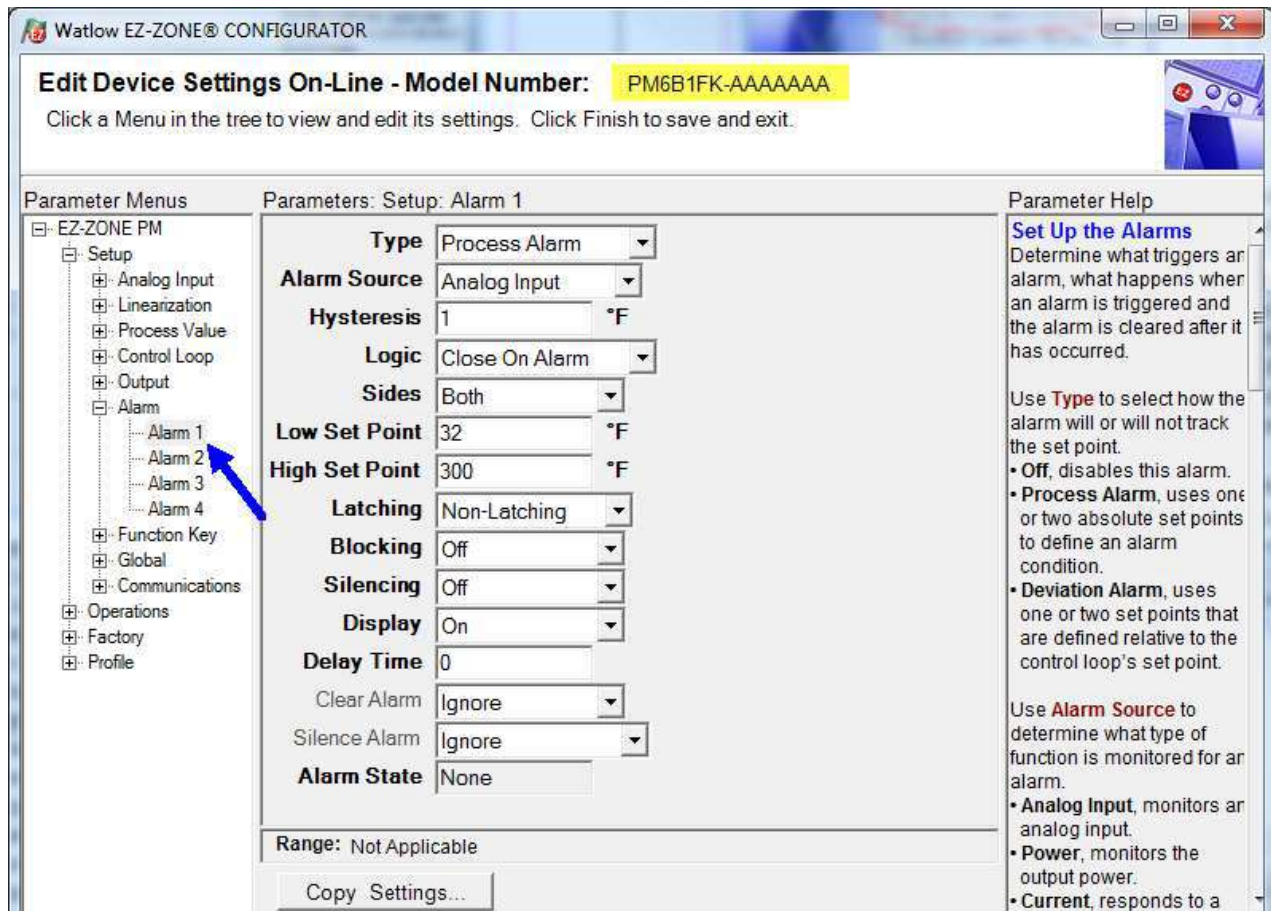

Navigating from one menu to the next is easy and clearly visible. Simply slide the scroll bar up or down to display the menu and parameter of choice. If there is a need to bring greater focus and clarity to the parameters of interest simply click on the negative symbol next to any of the Menu items. As an example if it is desired to work within the Operations page click the negative sign next to Setup where the Setup Page will then collapse. Now click the plus sign next to Operations to find the menu items of choice without viewing unwanted menus and parameters. Once the focus is brought to an individual parameter (single click of mouse) as is the case for Analog Input 1 in the left column; all that can be setup related to that parameter will appear in the center column. The grayed out fields in the center column simply mean that this does not apply for the type of sensor selected. As an example, notice that when a thermocouple is selected, RTD Leads does not apply and is therefore grayed out. To speed up the process of configuration, notice that at the bottom of the center column there is an option to copy settings. If all alarms were to be setup the same click on "Copy Settings" where a copy dialog box will appear allowing for quick duplication of all settings. Notice too, that by clicking on any of those items in the center column that context sensitive help will appear for that particular item in the right hand column.

Lastly, when the configuration is complete click the "Finish" button at the bottom right of the previous screen shot. The screen that follows this action can be seen below.

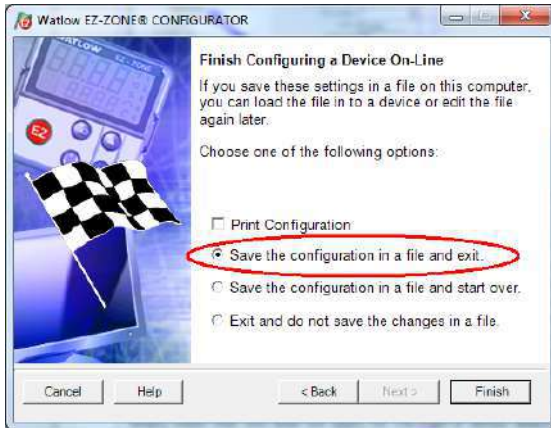

Although the PM control now contains the configuration (because the previous discussion focused on doing the configuration on-line) it is suggested that after the configuration process is completed that the user save this file on the PC for future use. If for some reason someone inadvertently changed a setting without understanding the impact, it would be easy and perhaps faster to download a saved configuration back to the control versus trying to figure out what was changed. Of course, there is an option to exit without saving a copy to the local hard drive. After selecting Save above, click the "Finish" button once again. The screen below will then appear. When saving the configuration, note the location where the file will be placed (saved in) and enter the file name (File name) as well. The default path for saved files follows:

*Users\ "Username" \My Documents\ Watlow\EZ-Zone Configurator\ Saved Configurations*

The user can save the file to any folder of choice.

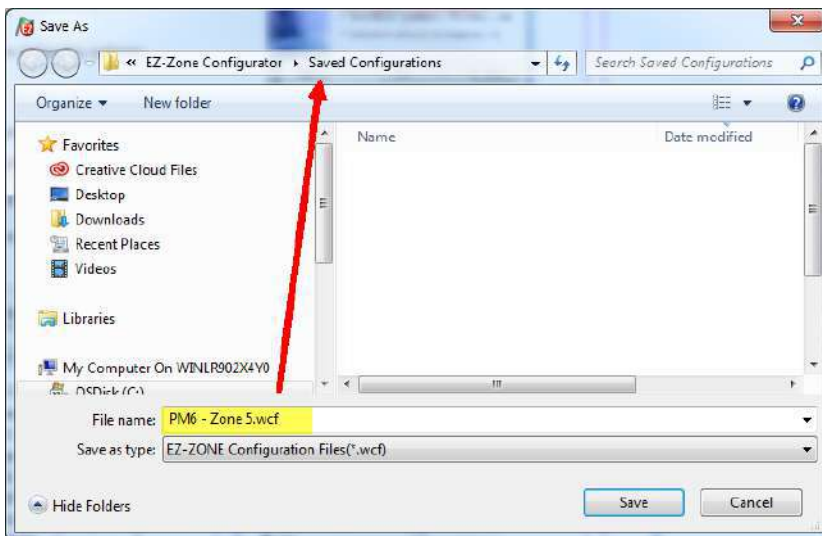

# Chapter 10: Appendix

## Troubleshooting Alarms, Errors and Control Issues

Indication	Description	Possible Cause(s)	Corrective Action
Alarm won't clear or reset	Alarm will not clear or reset with keypad or digital input	<ul style="list-style-type: none"> <li>• Latching is active</li> <li>• Alarm set to incorrect output</li> <li>• Alarm is set to incorrect source</li> <li>• Sensor input is out of alarm set point range</li> <li>• Alarm set point is incorrect</li> <li>• Alarm is set to incorrect type</li> <li>• Digital input function is incorrect</li> </ul>	<ul style="list-style-type: none"> <li>• Reset alarm when process is within range or disable latching</li> <li>• Set output to correct alarm source instance</li> <li>• Set alarm source to correct input instance</li> <li>• Correct cause of sensor input out of alarm range</li> <li>• Set alarm set point to correct trip point</li> <li>• Set alarm to correct type: process, deviation or power</li> <li>• Set digital input function and source instance</li> </ul>
Alarm won't occur	Alarm will not activate output	<ul style="list-style-type: none"> <li>• Silencing is active</li> <li>• Blocking is active</li> <li>• Alarm is set to incorrect output</li> <li>• Alarm is set to incorrect source</li> <li>• Alarm set point is incorrect</li> <li>• Alarm is set to incorrect type</li> </ul>	<ul style="list-style-type: none"> <li>• Disable silencing, if required</li> <li>• Disable blocking, if required</li> <li>• Set output to correct alarm source instance</li> <li>• Set alarm source to correct input instance</li> <li>• Set alarm set point to correct trip point</li> <li>• Set alarm to correct type: process, deviation or power</li> </ul>
Alarm Error <i>ALE 1</i> <i>ALE 2</i> <i>ALE 3</i> <i>ALE 4</i>	Alarm state cannot be determined due to lack of sensor input	<ul style="list-style-type: none"> <li>• Sensor improperly wired or open</li> <li>• Incorrect setting of sensor type</li> <li>• Calibration corrupt</li> </ul>	<ul style="list-style-type: none"> <li>• Correct wiring or replace sensor</li> <li>• Match setting to sensor used</li> <li>• Check calibration of controller</li> </ul>

Indication	Description	Possible Cause(s)	Corrective Action
Alarm Low <i>ALL 1</i> <i>ALL 2</i> <i>ALL 3</i> <i>ALL 4</i>	Sensor input below low alarm set point	<ul style="list-style-type: none"> <li>• Temperature is less than alarm set point</li> <li>• Alarm is set to latching and an alarm occurred in the past</li> <li>• Incorrect alarm set point</li> <li>• Incorrect alarm source</li> </ul>	<ul style="list-style-type: none"> <li>• Check cause of under temperature</li> <li>• Clear latched alarm</li> <li>• Establish correct alarm set point</li> <li>• Set alarm source to proper setting</li> </ul>
Alarm High <i>ALh 1</i> <i>ALh 2</i> <i>ALh 3</i> <i>ALh 4</i>	Sensor input above high alarm set point	<ul style="list-style-type: none"> <li>• Temperature is greater than alarm set point</li> <li>• Alarm is set to latching and an alarm occurred in the past</li> <li>• Incorrect alarm set point</li> <li>• Incorrect alarm source</li> </ul>	<ul style="list-style-type: none"> <li>• Check cause of over temperature</li> <li>• Clear latched alarm</li> <li>• Establish correct alarm set point</li> <li>• Set alarm source to proper setting</li> </ul>
Error Input <i>Er.i 1</i>	Sensor does not provide a valid signal to controller	<ul style="list-style-type: none"> <li>• Sensor improperly wired or open</li> <li>• Incorrect setting of sensor type</li> <li>• Calibration corrupt</li> </ul>	<ul style="list-style-type: none"> <li>• Correct wiring or replace sensor</li> <li>• Match setting to sensor used</li> <li>• Check calibration of controller</li> </ul>
Ambient Error <i>Er.Ab</i>	Sensor does not provide a valid signal to controller	<ul style="list-style-type: none"> <li>• Ambient error - cold junction circuitry not working</li> </ul>	<ul style="list-style-type: none"> <li>• Return to factory for repair</li> </ul>
Loop Open Error <i>LP.o 1</i>	Open Loop Detect is active and the process value did not deviate by a user-selected value in a user specified period with PID power at 100%.	<ul style="list-style-type: none"> <li>• Setting of Open Loop Detect Time incorrect</li> <li>• Setting of Open Loop Detect Deviation incorrect</li> <li>• Thermal loop is open</li> <li>• Open Loop Detect function not required but activated</li> </ul>	<ul style="list-style-type: none"> <li>• Set correct Open Loop Detect Time for application</li> <li>• Set correct Open Loop Deviation value for application</li> <li>• Determine cause of open thermal loop: misplaced sensors, load failure, loss of power to load, etc.</li> <li>• Deactivate Open Loop Detect feature</li> </ul>

Indication	Description	Possible Cause(s)	Corrective Action
Loop Reversed Error <i>LP.r I</i>	Open Loop Detect is active and the process value is headed in the wrong direction when the output is activated based on deviation value and user-selected value.	<ul style="list-style-type: none"> <li>• Setting of Open Loop Detect Time incorrect</li> <li>• Setting of Open Loop Detect Deviation incorrect</li> <li>• Output programmed for incorrect function</li> <li>• Thermocouple sensor wired in reverse polarity</li> </ul>	<ul style="list-style-type: none"> <li>• Set correct Open Loop Detect Time for application</li> <li>• Set correct Open Loop Deviation value for application</li> <li>• Set output function correctly</li> <li>• Wire thermocouple correctly, (red wire is negative)</li> </ul>
Ramping <i>rP I</i>	Controller is ramping to new set point	<ul style="list-style-type: none"> <li>• Ramping feature is activated</li> </ul>	<ul style="list-style-type: none"> <li>• Disable ramping feature if not required</li> </ul>
Autotuning <i>tUn I</i>	Controller is autotuning the control loop	<ul style="list-style-type: none"> <li>• User started the autotune function</li> <li>• Digital input is set to start autotune</li> </ul>	<ul style="list-style-type: none"> <li>• Wait until autotune completes or disable autotune feature</li> <li>• Set digital input to function other than autotune, if desired</li> </ul>
No heat/cool action	Output does not activate load	<ul style="list-style-type: none"> <li>• Output function is incorrectly set</li> <li>• Control mode is incorrectly set</li> <li>• Output is incorrectly wired</li> <li>• Load, power or fuse is open</li> <li>• Control set point is incorrect</li> <li>• Incorrect controller model for application</li> </ul>	<ul style="list-style-type: none"> <li>• Set output function correctly</li> <li>• Set control mode appropriately (Open vs Closed Loop)</li> <li>• Correct output wiring</li> <li>• Correct fault in system</li> <li>• Set control set point in appropriate control mode and check source of set point: remote, idle, profile, closed loop, open loop</li> <li>• Obtain correct controller model for application</li> </ul>

Indication	Description	Possible Cause(s)	Corrective Action
No Display	No display indication or LED illumination	<ul style="list-style-type: none"> <li>• Power to controller is off</li> <li>• Fuse open</li> <li>• Breaker tripped</li> <li>• Safety interlock switch open</li> <li>• Separate system limit control activated</li> <li>• Wiring error</li> <li>• Incorrect voltage to controller</li> </ul>	<ul style="list-style-type: none"> <li>• Turn on power</li> <li>• Replace fuse</li> <li>• Reset breaker</li> <li>• Close interlock switch</li> <li>• Reset limit</li> <li>• Correct wiring issue</li> <li>• Apply correct voltage, check part number</li> </ul>
No Serial Communication	Cannot establish serial communications with the controller	<ul style="list-style-type: none"> <li>• Address parameter incorrect</li> <li>• Incorrect protocol selected</li> <li>• Baud rate incorrect</li> <li>• Parity incorrect</li> <li>• Wiring error</li> <li>• EIA-485 converter issue</li> <li>• Incorrect computer or PLC communications port</li> <li>• Incorrect software setup</li> <li>• Wires routed with power cables</li> <li>• Termination resistor may be required</li> </ul>	<ul style="list-style-type: none"> <li>• Set unique addresses on network</li> <li>• Match protocol between devices</li> <li>• Match baud rate between devices</li> <li>• Match parity between devices</li> <li>• Correct wiring issue</li> <li>• Check settings or replace converter</li> <li>• Set correct communication port</li> <li>• Correct software setup to match controller</li> <li>• Route communications wires away from power wires</li> <li>• Place 120 <math>\Omega</math> resistor across EIA-485 on last controller</li> </ul>
Process doesn't control to set point	Process is unstable or never reaches set point	<ul style="list-style-type: none"> <li>• Controller not tuned correctly</li> <li>• Control mode is incorrectly set</li> <li>• Control set point is incorrect</li> </ul>	<ul style="list-style-type: none"> <li>• Perform autotune or manually tune system</li> <li>• Set control mode appropriately (Open vs Closed Loop)</li> <li>• Set control set point in appropriate control mode and check source of set point: remote, idle, profile, closed loop, open loop</li> </ul>

Indication	Description	Possible Cause(s)	Corrective Action
Temperature runaway	Process value continues to increase or decrease past set point.	<ul style="list-style-type: none"> <li>• Controller output incorrectly programmed</li> <li>• Thermocouple reverse wired</li> <li>• Controller output wired incorrectly</li> <li>• Short in heater</li> <li>• Power controller connection to controller defective</li> <li>• Controller output defective</li> </ul>	<ul style="list-style-type: none"> <li>• Verify output function is correct (heat or cool)</li> <li>• Correct sensor wiring (red wire negative)</li> <li>• Verify and correct wiring</li> <li>• Replace heater</li> <li>• Replace or repair power controller</li> <li>• Replace or repair controller</li> </ul>
Device Error <i>100</i> <i>rErr</i>	Controller displays internal malfunction message at power up.	<ul style="list-style-type: none"> <li>• Controller defective</li> <li>• Sensor input over driven</li> </ul>	<ul style="list-style-type: none"> <li>• Replace or repair controller</li> <li>• Check sensors for ground loops, reverse wiring or out of range values.</li> </ul>
Menus inaccessible	Unable to access <i>SEt</i> , <i>oPEr</i> , <i>FCLY</i> or <i>PrOF</i> menus or particular prompts in Home Page	<ul style="list-style-type: none"> <li>• Security set to incorrect level</li> <li>• Digital input set to lock-out keypad</li> <li>• Custom parameters incorrect</li> </ul>	<ul style="list-style-type: none"> <li>• Check <i>LoC</i> settings in Factory Page and enter appropriate password in <i>ULoC</i> setting in Factory Page</li> <li>• Change state of digital input</li> <li>• Change custom parameters in Factory Page</li> </ul>
EZ-Key/s do not work	EZ-Key/s do not activate required function	<ul style="list-style-type: none"> <li>• EZ-Key function incorrect</li> <li>• EZ-Key function instance not correct</li> <li>• Keypad malfunction</li> </ul>	<ul style="list-style-type: none"> <li>• Verify EZ-Key function in the Setup Menu</li> <li>• Correct and change the function instance if not correct</li> <li>• Replace or repair controller</li> </ul>
Displayed value to low <i>uALL</i>	Value to low to be displayed in 4 digit LED display <-1999	<ul style="list-style-type: none"> <li>• Incorrect setup</li> </ul>	<ul style="list-style-type: none"> <li>• Check scaling of source data</li> </ul>
Displayed value to high <i>uALh</i>	Value to high to be displayed in 4 digit LED display >9999	<ul style="list-style-type: none"> <li>• Incorrect setup</li> </ul>	<ul style="list-style-type: none"> <li>• Check scaling of source data</li> </ul>

<b>Detection of and Rules Around Abnormal Sensor Conditions</b>	
<b>Inputs</b>	<b>Detection of Abnormal Conditions</b>
<b>Thermocouple</b>	
Shorted	No direct detection, Open loop firmware detection.
Open	Yes, Parasitic pull-up
Reversed	Yes, firmware detection
<b>Current Source</b>	
Shorted	Range limiting only
Open	Range limiting only
Reversed	Range limiting only
<b>Voltage Source</b>	
Open	Range limiting only
Shorted	Range limiting only
Reversed	Range limiting only
<b>RTD</b>	
S1 open	Yes, pulled up.
S2 open	Not implemented.
S3 open	Yes, pulled up.
S1 short to S2	Yes, pulled up
S1 short to S3	Yes, pulled down to under range.
S2 shorted to S3	Not implemented, Possible, monitor S2 voltage.
S1 and S2 open	Yes, pulled down to under range.
S1 and S3 open	Yes, S1 pulled up.
S2 and S3 open	Yes pulled up.
<b>Thermistor</b>	
S1 open	Yes, pulled up to sensor over range.
S3 open	Yes, pulled up to sensor over range.
S1 short to S3	Yes, pulled down to sensor under range.
S1 and S3 open	Yes, S1 pulled up to sensor over range.



## Modbus - Programmable Memory Blocks

The Modbus assembly or programmable memory blocks consists of 40 pointers to the parameters of your choosing starting at Modbus register 40 (shown on the following page). The pointers are 32-bits long and are stored in two sequential registers. As an example, if it is desired to move an alias to the Set Point of the PM (register 2160) into pointer registers 40 and 41, a single multi-write command (0x10 function) would be used writing 2160 into register 40 and 2161 into register 41.

Once the parameters of choice have been defined and written to the specified pointer registers, the working registers will then represent the parameters written. In the example above, the 32-bit floating point Set Point (2160 and 2161) was first written to registers 40 and 41 which in turn defines working registers 200 and 201 as Set Point. As can be seen in the graphic below, reading back registers 200 and 201 the Set Point is displayed.

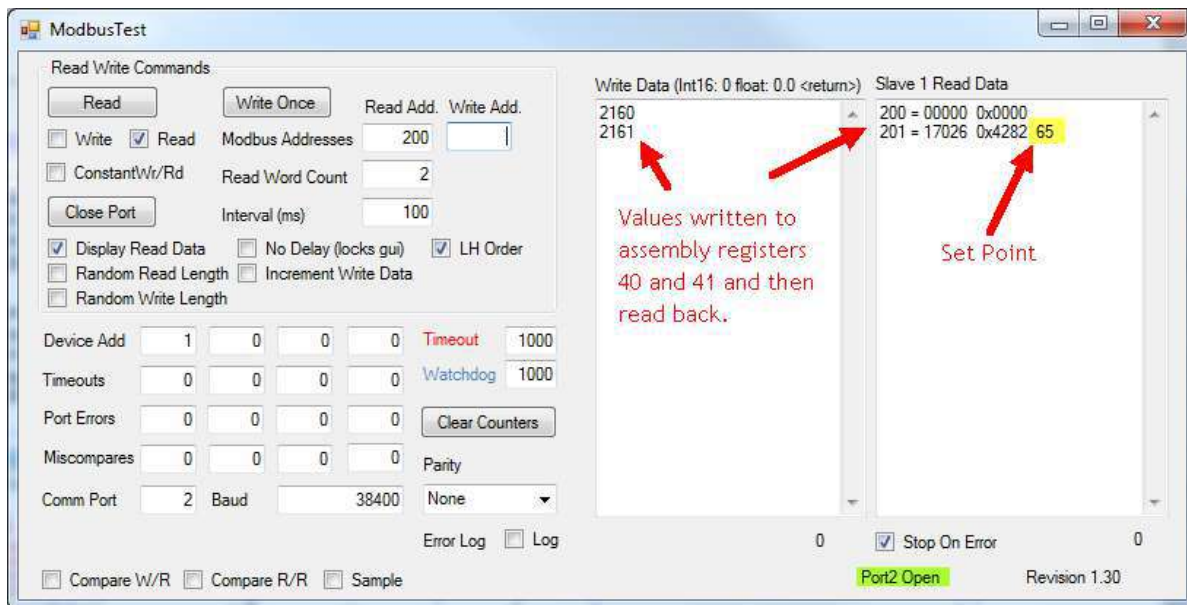

The screen shot above was taken from a program that can be found on the Watlow Support Tools DVD (shipped with the product) as well as on the Watlow website. On the DVD, it can be found under "Utility Tools" and is identified as "Modbus RTU Diagnostic Program for EZ-ZONE PM, RM and ST". A similar program can be found here as well for Modbus TCP. If it is easier to go to the web to acquire this software, click on the link below and type "modbus" in the search field where both versions can be found and downloaded.

## Assembly Definition Addresses and Assembly Working Addresses

Pointer Registers	Working Registers
40 & 41	200 & 201
42 & 43	202 & 203
44 & 45	204 & 205
46 & 47	206 & 207
48 & 49	208 & 209
50 & 51	210 & 211
52 & 53	212 & 213
54 & 55	214 & 215
56 & 57	216 & 217
58 & 59	218 & 219
60 & 61	220 & 221
62 & 63	222 & 223
64 & 65	224 & 225
66 & 67	226 & 227
68 & 69	228 & 229
70 & 71	230 & 231
72 & 73	232 & 233
74 & 75	234 & 235
76 & 77	236 & 237
78 & 79	238 & 239
80 & 81	240 & 241
82 & 83	242 & 243
84 & 85	244 & 245
86 & 87	246 & 247
88 & 89	248 & 249
90 & 91	250 & 251
92 & 93	252 & 253
94 & 95	254 & 255
96 & 97	256 & 257
98 & 99	256 & 259
100 & 101	260 & 261
102 & 103	262 & 263
104 & 105	264 & 265
106 & 107	266 & 267
108 & 109	268 & 269
110 & 111	270 & 271
112 & 113	272 & 273
114 & 115	274 & 275
116 & 117	276 & 277
118 & 119	278 & 279

# Modbus Default Assembly Structure 40-119

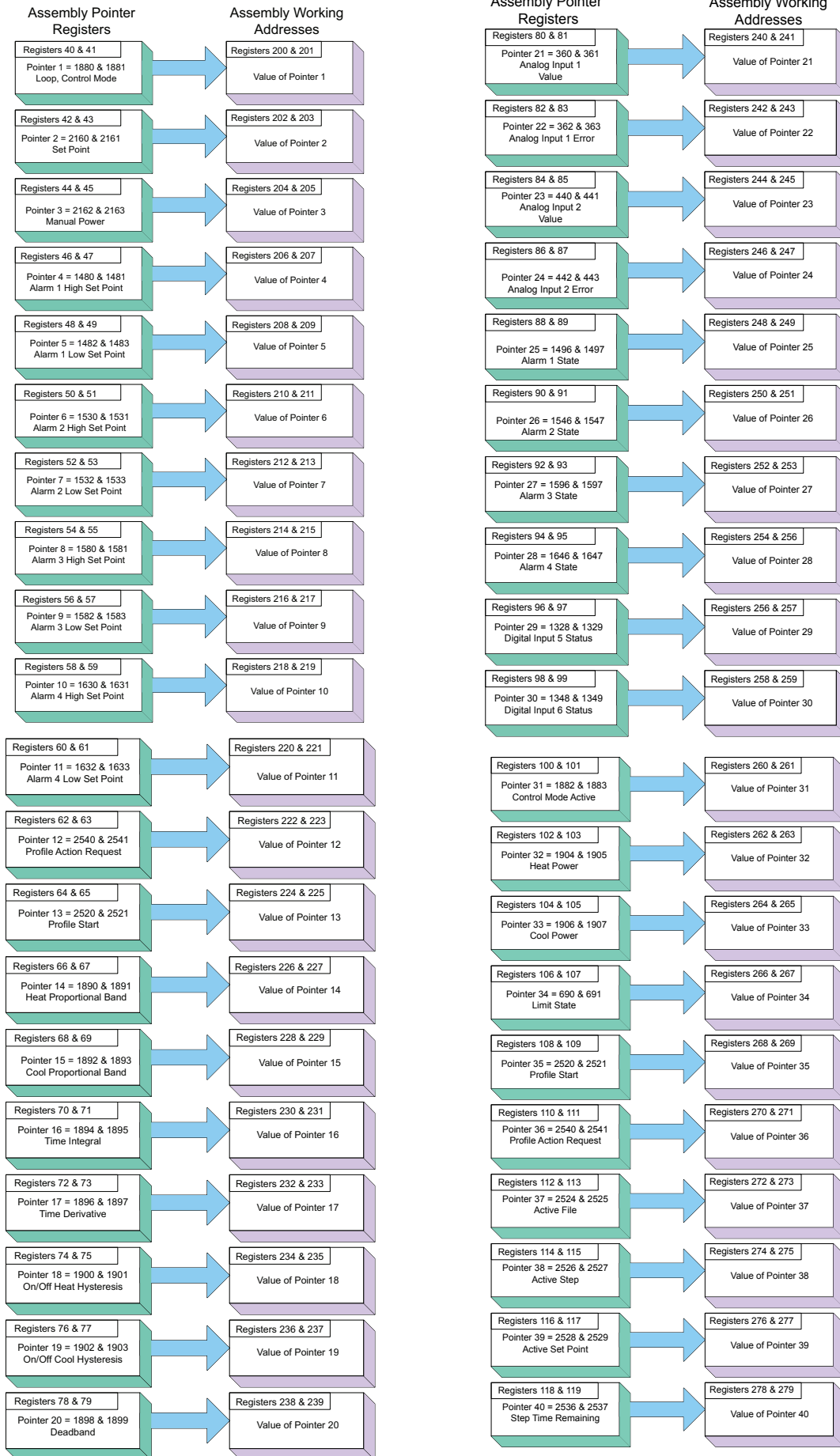

## PM Specifications

### Line Voltage/Power (Minimum/Maximum Ratings)

- 85 to 264V~ (ac), 47 to 63Hz
- 20 to 28V~ (ac), 47 to 63Hz
- 12 to 40V= (dc)
- 14VA maximum power consumption (PM4, 8 & 9)
- 10VA maximum power consumption (PM6)
- Data retention upon power failure via non-volatile memory
- Compliant with SEMIF47-0200, Figure R1-1 voltage sag requirements @ 24V~ (ac) or higher

### Environment

- 0 to 149°F (-18 to 65°C) operating temperature
- -40 to 185°F (-40 to 85°C) storage temperature
- 0 to 90% RH, non-condensing

### Accuracy

- Calibration accuracy and sensor conformity:  $\pm 0.1\%$  of span,  $\pm 1^\circ\text{C}$  @ the calibrated ambient temperature and rated line voltage
- Types R, S, B; 0.2%
- Type T below  $-50^\circ\text{C}$ ; 0.2%
- Calibration ambient temperature @  $77 \pm 5^\circ\text{F}$  ( $25 \pm 3^\circ\text{C}$ )
- Accuracy span :1000 °F (540°C) min.
- Temperature stability:  $\pm 0.1^\circ\text{F}/^\circ\text{F}$  ( $\pm 0.1^\circ\text{C}/^\circ\text{C}$ ) rise in ambient max.

### Agency Approvals

- UL® Listed to UL 61010-1 File E185611
- UL Reviewed to CSA C22.2 No.61010-1-04
- UL 50 Type 4X, NEMA 4X indoor locations, IP65 front panel seal (indoor use only)
- FM Class 3545 File 3029084 temperature limit switches
- CE-See Declaration of Conformity RoHS and W.E.E.E. complaint
- UL Listed to ANSI/ISA 12.12.01-2007 File E184390
- This equipment is suitable for use in Class 1, Div.2, Groups A, B, C and D or non-hazardous locations only. Temperature Code T4A
- UL reviewed to Standard No. CSA C22.2 No.213-M1987, Canadian Hazardous locations
- All models, CSA C22.2 No. 24 File 158031 Class 4813-02, CSA Approved

### Controller

- User selectable heat/cool, on-off, P, PI, PD, PID or alarm action
- Auto-tune with TRU-TUNE®+ adaptive control algorithm
- Control sampling rates: input = 10Hz, outputs = 10Hz

### Profile Ramp/Soak - Real Time Clock and Battery Back-up

- Accuracy (typical):  $\pm 30\text{PPM}$  at  $77^\circ\text{F}$  ( $25^\circ\text{C}$ )
- $+30/-100\text{ PPM}$  at  $-4$  to  $149^\circ\text{F}$  ( $-20$  to  $65^\circ\text{C}$ )
- Battery type: Rayovac 3V (BR1225) lithium (recycle properly). Battery is available only on models with real-time clock
- Battery typical life: three cumulative years of life without power at  $77^\circ\text{F}$  ( $25^\circ\text{C}$ )

## Isolated Serial Communications

- EIA232/485, Modbus® RTU

## Wiring Termination—Touch-Safe Terminals

- Input, power and controller output terminals are touch safe removable 3.30 to 0.0507 mm<sup>2</sup> (12 to 22 AWG)
- Wire strip length 7.6 mm (0.30 in.)
- Torque 0.56 Nm (5.0 in-lb)

## Universal Input

- Thermocouple, grounded or ungrounded sensors
  - >20MΩ input impedance
- Max. 2kΩ source resistance
- 3μA open sensor detection
- RTD 2- or 3-wire, platinum, 100Ω and 1kΩ @ 0°C (32°F) calibration to DIN curve (0.00385 Ω/Ω/°C)
- Process, 0-20mA @100Ω, or 0-10V<sub>rms</sub> (dc) @ 20kΩ input impedance; scalable, 0-50mV

### Voltage Input Ranges

- Accuracy ±10mV ±1 LSD at standard conditions
- Temperature stability ±100 PPM/°C maximum

### Milliamp Input Ranges

- Accuracy ±20μA ±1 LSD at standard conditions
- Temperature stability ±100 PPM/°C maximum

### Resolution Input Ranges

- 0 to 10V: 200μV nominal
- 0 to 20 mA: 0.5mA nominal

- Potentiometer: 0 to 1.2kΩ
- Inverse scaling

Input Type	Max Error @ 25 Deg C	Accuracy Range Low	Accuracy Range High	Units
J	±1.75	0	750	Deg C
K	±2.45	-200	1250	Deg C
T	±1.55	-200	350	Deg C
N	±2.25	0	1250	Deg C
E	±2.10	-200	900	Deg C
R	±3.9	0	1450	Deg C
S	±3.9	0	1450	Deg C
B	±2.66	870	1700	Deg C
C	±3.32	0	2315	Deg C
D	±3.32	0	2315	Deg C
F (PTII)	±2.34	0	1343	Deg C
RTD, 100 ohm	±2.00	-200	800	Deg C
RTD, 1000 ohm	±2.00	-200	800	DegC
mV	±0.05	-50	50	mV

Input Type	Max Error @ 25 Deg C	Accuracy Range Low	Accuracy Range High	Units
Volts	±0.01	0	10	Volts
mAdc	±0.02	0	20	mAmps DC
mAac	±5	0	50	mAmps AC

Operating Range			
Input Type	Range Low	Range High	Units
J	-210	1200	Deg C
K	-270	1371	Deg C
T	-270	400	Deg C
N	-270	1300	Deg C
E	-270	1000	Deg C
R	-50	1767	Deg C
S	-50	1767	Deg C
B	0	1816	Deg C
C	0	2315	Deg C
D	0	2315	Deg C
F (PTII)	0	1343	Deg C
RTD (100 ohm)	-200	800	Deg C
RTD (1000 ohm)	-200	800	Deg C
mV	0	50	mV
Volts	0	10	Volts
mAdc	0	20	mAmps DC
mAac	0	50	mAmps AC
Potentiometer, 1K range	0	1200	Ohms
Resistance, 5K range	0	5000	Ohms
Resistance, 10K range	0	10000	Ohms
Resistance, 20K range	0	20000	Ohms
Resistance, 40K range	0	40000	Ohms

Thermistor Input				
Input Type	Max Error @ 25 Deg C	Accuracy Range Low	Accuracy Range High	Units
Thermistor, 5K range	±5	0	5000	Ohms
Thermistor, 10K range	±10	0	10000	Ohms
Thermistor, 20K range	±20	0	20000	Ohms
Thermistor, 40K range	±40	0	40000	Ohms

- 0 to 40kΩ, 0 to 20kΩ, 0 to 10kΩ, 0 to 5kΩ
- 2.252kΩ and 10kΩ base at 25°C
- Linearization curves built in
- Third party Thermistor compatibility requirements

Base R @ 25C	Alpha Techniques	Beta THERM	YSI	Thermistor Curve
2.252K	Curve A	2.2K3A	004	A
10K	Curve A	10K3A	016	B
10K	Curve C	10K4A	006	C

## 2 Digital Input/Output Option - 2 DIO

- Digital input update rate 10Hz
  - DC voltage
    - Max. input 36V @ 3mA
    - Min. high state 3V at 0.25mA
    - Max. low state 2V
  - Dry contact
    - Min. open resistance 10k $\Omega$
    - Max. closed resistance 50 $\Omega$
    - Max. short circuit 13mA
- Digital output update rate 10Hz
  - SSR drive signal
  - Update rate 10 Hz
  - Maximum open circuit voltage is 22 to 25 $\approx$  (dc)
  - PNP transistor source
  - Typical drive; 21mA @ 4.5V for DO5, and 11mA @ 4.5V for DO6
  - Current limit 24mA for Output 5 and 12mA Output 6
  - Output 5 capable of driving one 3 - pole DIN-A-MITE
  - Output 6 capable of driving one 1 - pole DIN-A-MITE

## Output Hardware

- Switched DC
  - Maximum open circuit voltage is 22 to 25V $\approx$  (dc)
  - 30mA max. per single output / 40mA max. total per paired outputs (1 & 2, 3 & 4)
  - Typical drive; 4.5V $\approx$  (dc) @ 30mA
  - Short circuit limited to <50mA
  - Use dc- and dc+ to drive external solid-state relay
  - 1-pole DIN-A-MITE: up to 4 in parallel or 4 in series
  - 2-pole DIN-A-MITE: up to 2 in parallel or 2 in series
  - 3-pole DIN-A-MITE: up to 2 in series
- Switched dc/open collector = 30V $\approx$  (dc) max. @ 100mA max. current sink
- Solid State Relay (SSR), FormA, 0.5A @ 24V $\sim$  (ac) min., 240V $\sim$  (ac) max., 1A at 50°F linear derating to 0.5A at 149°F resistive, opto-isolated, without contact suppression, 120/240V $\sim$  (ac) 20 VA pilot duty
- Minimum holding current of 10mA

- Electromechanical relay, Form C, 5A, 24 to 240V~ (ac) or 30V= (dc) max., resistive load, 100,000 cycles at rated load, 125 VA pilot duty at 120/240V~ (ac), 25 VA at 24V~ (ac)
- Electromechanical relay, FormA, 5A, 24 to 240V~ (ac) or 30V= (dc) max., resistive load, 100,000 cycles at rated load, 125 VA pilot duty at 120/240V~ (ac), 25 VA at 24V~ (ac)
- NO-ARC relay, FormA, 15A, 24 to 240V~ (ac), no V= (dc), resistive load, 2 million cycles at rated load
- Universal process/retransmit, Output range selectable:
  - 0 to 10V= (dc) into a min. 1k $\Omega$  load
  - 0 to 20mA into max. 800 $\Omega$  load

**Resolution**

- dc ranges: 2.5mV nominal
- mA ranges: 5 $\mu$ A nominal

**Calibration Accuracy**

- dc ranges:  $\pm$ 15mV
- mA ranges:  $\pm$ 30 $\mu$ A

**Temperature Stability**

- 100 ppm/ $^{\circ}$ C

**Operator Interface**

- Dual 4 digit, 7 segment LED displays
- Advance, infinity, up and down keys, plus optional programmable EZ-KEY/s depending on model size
- Typical display update rate 1Hz
- RESET key substituted for infinity on all models including the limit control

Dimensions				
Size	Behind Panel (max.)	Width	Height	Display Character Height
1/32	101.6 mm (4.00 in)	53.3 mm (2.10 in)	30.9 mm (1.22 in)	Large: 7.62 mm (0.300 in) Small: 5.59 mm (0.220 in)
1/4	100.8 mm (3.97 in)	100.3 mm (3.95 in)	100.3 mm (3.95 in)	Large: 20.32 mm (0.800 in) Medium: 12.70 mm (0.500 in) Small: 10.16 mm (0.400 in)
1/16	101.6 mm (4.00 in)	53.3 mm (2.10 in)	53.3 mm (2.10 in)	Large: 10.16 mm (0.400 in) Small: 5.97 mm (0.235 in)
1/8 (H)	101.6 mm (4.00 in)	100.3 mm (3.95 in)	54.8 mm (2.16 in)	Large: 11.4 mm (0.450 in) Medium: 9.53 mm (0.375 in) Small: 7.62 mm (0.300 in)
1/8 (V)	101.6 mm (4.00 in)	54.8 mm (2.16 in)	100.3 mm (3.95 in)	Large: 11.4 mm (0.450 in) Medium: 9.53 mm (0.375 in) Small: 7.62 mm (0.300 in)



Weight	
<b>1/32 DIN (PM3)</b> <ul style="list-style-type: none"> <li>Controller: 127 g (4.5 oz.)</li> </ul>	<b>1/4 DIN (PM4)</b> <ul style="list-style-type: none"> <li>Controller: 331 g (11.7 oz.)</li> </ul>
<b>1/8 DIN (PM8 and 9)</b> <ul style="list-style-type: none"> <li>Controller: 284 g (10 oz.)</li> </ul>	<b>1/16 DIN (PM6)</b> <ul style="list-style-type: none"> <li>Controller: 186 g (6.6 oz.)</li> </ul>
<b>User's Guide</b> <ul style="list-style-type: none"> <li>User's Guide: 284.86 g (10.1 oz)</li> </ul>	

Modbus® is a trademark of AEG Schneider Automation Inc.

UL® is a registered trademark of Underwriters Laboratories Inc.

**Note:**

These specifications are subject to change without prior notice.

# Ordering Information for PID Controller Models

## Controller

EZ-ZONE® PID Controller Models  
TRU-TUNE+® Adaptive Tune, red-green 7-segment displays

## Package Size

- 3 Panel Mount 1/32 DIN
- 6 Panel Mount 1/16 DIN
- 8 Panel Mount 1/8 DIN Vertical
- 9 Panel Mount 1/8 DIN Horizontal
- 4 Panel Mount 1/4 DIN Horizontal

## Primary Function

- C PID Controller with Universal Input
- R PID Controller with Universal Input and Profiling Ramp and Soak
- T PID Controller with Universal Input and Timer
- B PID Controller with Universal Input and Profiling Ramp and Soak and Battery Backup with Real Time Clock
- J PID Controller with Thermistor Input
- N PID Controller with Thermistor Input and Profiling Ramp and Soak
- E PID Controller with Thermistor Input and Profiling Ramp and Soak and Battery Backup with Real Time Clock
- S Custom Firmware

- Options B and E are not available with PM3 or PM6

## Power Supply, Digital Input/Output

- 1 100 to 240V~ (ac)
- 2 100 to 240V~ (ac) plus 2 Digital I/O points
- 3 15 to 36V= (dc) and 24V~ (ac)
- 4 15 to 36V= (dc) and 24V~ (ac), plus 2 Digital I/O points

## Output 1 and 2 Hardware Options

### Output 1

- CA Switched dc/open collector
- CH Switched dc/open collector
- CC Switched dc/open collector
- CJ Switched dc/open collector
- CK Switched dc/open collector
- EA Mechanical relay 5 A, form C
- EH Mechanical relay 5 A, form C
- EC Mechanical relay 5 A, form C
- EJ Mechanical relay 5 A, form C
- EK Mechanical relay 5 A, form C
- FA Universal process
- FC Universal process
- FJ Universal process
- FK Universal process
- AK None
- KH Solid-State Relay 0.5 A, form A
- KK Solid-State Relay 0.5 A, form A

### Output 2

- None
- NO-ARC 15 A power control
- Switched dc
- Mechanical relay 5 A, form A
- Solid-State Relay 0.5 A, form A
- None
- NO-ARC 15 A power control
- Switched dc
- Mechanical relay 5 A, form A
- Solid-State Relay 0.5 A, form A
- None
- Switched dc (cannot use variable time base)
- Mechanical relay 5 A, form A (cannot use variable time base)
- Solid-State Relay 0.5 A, form A (cannot use variable time base)
- Solid-State Relay 0.5 A, form A
- NO-ARC 15 A power control
- Solid-state relay 0.5 A, form A

- Options CH, EH and KH are not available with PM3 (1/32 DIN)

## Communications Options

- A None
- 1 EIA 485 Modbus RTU®

- Standard Bus EIA-485 always included - all models

## Future Options

- AAA None

## Isolated Input Option

- A None
- D Isolated Input 1

## Custom Options

- AA Standard EZ-ZONE face plate
- 12 Class 1, Div. 2 (Not available with mechanical relay output types E, H, J)
- AB EZ-ZONE logo and no Watlow name
- AC No logo and no Watlow name
- AG Conformal coating
- XX Custom firmware, overlays, parameter settings

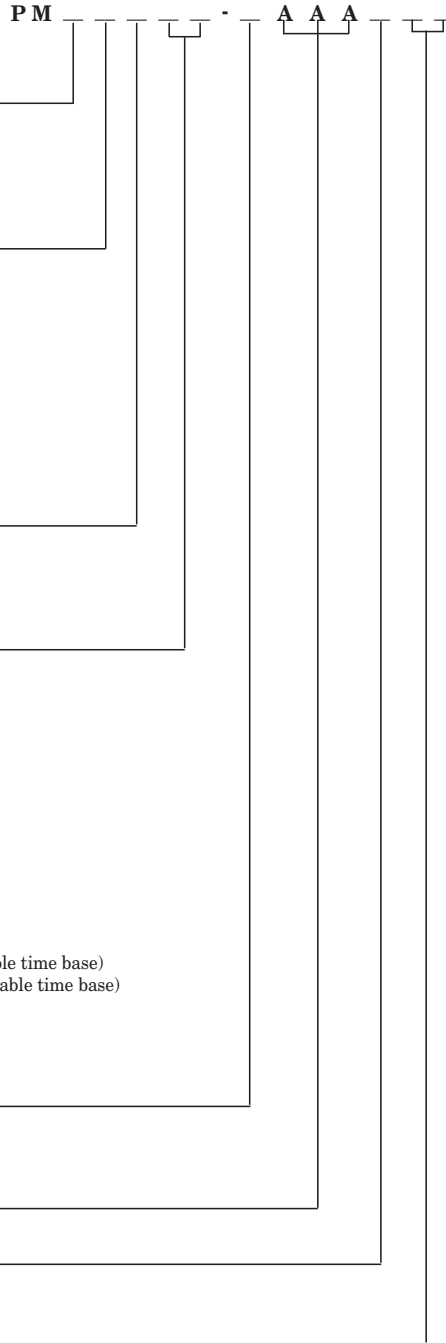

# Declaration of Conformity

## Series EZ-ZONE<sup>®</sup> PM



**WATLOW Electric Manufacturing Company**

ISO 9001 since 1996.

1241 Bundy Blvd.  
Winona, MN 55987 USA

Declares that the following product:

Designation: **Series EZ-ZONE<sup>®</sup> PM (Panel Mount)**  
Model Numbers: PM (3, 6, 8, 9 or 4)(Any Letter or number) – (1, 2, 3 or 4)(A, C, E, F or K) (A, C, H, J or K)(Any letter or number) – (Any letter or number)(A, C, E, F or K)(A, C, H, J or K) (Any three letters or numbers)  
Classification: Temperature control, Installation Category II, Pollution degree 2, IP65  
Rated Voltage and Frequency: 100 to 240 V~ (ac 50/60 Hz) **or** 15 to 36 V=dc/ 24 V~ac 50/60 Hz  
Rated Power Consumption: 10 VA maximum PM3, PM6 Models.  
14 VA maximum PM8, PM9, PM4 Models

Meets the essential requirements of the following European Union Directives by using the relevant standards show below to indicate compliance.

### ***2004/108/EC Electromagnetic Compatibility Directive***

<b>EN 61326-1</b>	<b>2013</b>	<b>Electrical equipment for measurement, control and laboratory use – EMC requirements (Industrial Immunity, Class B Emissions).</b>
EN 61000-4-2	2009	Electrostatic Discharge Immunity
EN 61000-4-3	2010	Radiated Field Immunity 10V/M 80–1000 MHz, 3 V/M 1.4–2.7 GHz
EN 61000-4-4	2012	Electrical Fast-Transient / Burst Immunity
EN 61000-4-5	2006	Surge Immunity (Also compliant with IEC 61000-4-5 2014)
EN 61000-4-6	2014	Conducted Immunity
EN 61000-4-11	2004	Voltage Dips, Short Interruptions and Voltage Variations Immunity
EN 61000-3-2	2009	Harmonic Current Emissions (Also compliant with IEC 61000-3-2 2014)
EN 61000-3-3 <sup>1</sup>	2013	Voltage Fluctuations and Flicker
SEMI F47	2000	Specification for Semiconductor Sag Immunity Figure R1-1

<sup>1</sup>For mechanical relay loads, cycle time may need to be extended up to 160 seconds to meet flicker requirements depending on load switched and source impedance.

### ***2006/95/EC Low-Voltage Directive***

**EN 61010-1**      **2011<sup>2</sup>**      **Safety Requirements of electrical equipment for measurement, control and laboratory use. Part 1: General requirements**

<sup>2</sup>Compliance with 3rd Edition requirements with use of external surge suppressor installed on 230 Vac~ power line units. Recommend minimum 1000 V peak to maximum 2000 V peak, 70 joules or better part be used.

### ***Compliant with 2011/65/EU RoHS2 Directive***

***Per 2012/19/EU W.E.E Directive***  ***Please Recycle Properly.***

Joe Millanes  
Name of Authorized Representative

Winona, Minnesota, USA  
Place of Issue

Director of Operations  
Title of Authorized Representative

September 2014  
Date of Issue

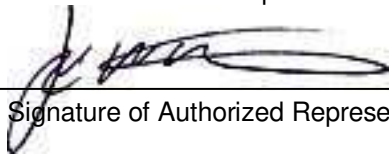
  
Signature of Authorized Representative