



# USER GUIDE

## Single or 3-Phase True RMS 1000A Power Clamp Meter with Non-Contact Voltage Detector and PC interface

Model PQ2071



## Introduction

Congratulations on your purchase of the Extech PQ2071 1/3-Phase CAT IV True RMS 1000A Power Clamp Meter. The PQ2071 measures AC Current, Frequency, Temperature (Type K), and Power (True Power, Apparent Power, Reactive Power, and Active Power). The PQ2071 also includes a built-in non-contact Voltage Detector with LED alert. The USB PC interface offers storage and recall (manually) of up to 99 sets of readings data. Proper use and care of this meter will provide many years of reliable service.

## Safety

### International Safety Symbols



This symbol, adjacent to another symbol or terminal, indicates the user must refer to the manual for further information.



This symbol, adjacent to a terminal, indicates that, under normal use, hazardous voltages may be present



Double insulation

This User Guide includes information concerning safety and cautions. Please read the information carefully and observe all of the Warnings and Notes.

To avoid electric shock or personal injury, read the “Safety Information” and “Rules for Safe Operation” carefully before using the Meter.

This device is a three phase handheld digital power clamp meter which has both the features of a digital current meter and also a power measurement meter.

### Unpacking Inspection

Check that the following items were included in the packaging. Please report missing or damaged items to the point of purchase.

Item	Description	Qty
1	User Guide	1 piece
2	Colored Test Leads	3 pieces
3	Black Test Lead	1 piece
4	Colored Alligator Clips	3 pieces
5	Black Alligator Clip	1 piece
6	USB Interface Cable	1 piece
7	Software	1 piece
8	Storage case	1 piece
9	9V Battery	1 piece

### General Safety Information

This Meter complies with the IEC61010 standard for pollution degree 2, overvoltage category (CAT III 1000V, CAT IV 600V), and double insulation.

Use the Meter only as specified in this operating manual, otherwise the protection provided by the Meter may be impaired.

In this manual, a Warning identifies conditions and actions that pose hazards to the user, or may damage the Meter or the equipment under test. A Note identifies general safety information that the user must observe.

### Rules for Safe Operation



#### Warning

To avoid possible electric shock or personal injury, and to avoid possible damage to the Meter or to the equipment under test, adhere to the following rules:

- Before using the Meter inspect the meter housing. Do not use the Meter if the housing is damaged, open, or removed. Look for cracks or missing plastic. Pay particular attention to the insulation around the connectors.
- Inspect the test leads for damaged insulation or exposed metal. Replace damaged test leads (identical model number or electrical specifications) before using Meter.
- Do not apply more than the rated voltage as specified on the Meter.
- When measurements have been completed, disconnect the connection between the test leads and the circuit under test, remove the testing leads from the input terminals of the Meter and turn the Meter power off.
- To avoid electrical shock, do not attempt measurements while the Meter's housing and / or battery door is opened.
- When the effective voltage exceeds 30VAC, special care should be taken while measuring as a shock hazard exists at this voltage level.
- Use the proper terminals and functions for the measurement in question.
- Do not use or store the Meter in an environment of high temperature, humidity, explosive, inflammable or one with a strong magnetic field.
- Do not use the Meter if the meter is wet or if the user's hands are wet.
- When using the test leads, keep fingers behind the finger guards.
- Replace the battery as soon as the battery indicator appears. With a low battery, the Meter may produce false readings that can mislead the user and cause electric shock and personal injury.
- When opening the battery door, ensure that the Meter power is OFF.
- When servicing the Meter, use only the same model number or identical electrical specifications when acquiring replacement parts.
- The internal circuit of the Meter must not be tampered with. Tampering with the internal circuitry can cause meter damage and personal injury.
- A soft cloth and a mild detergent should be used to clean the surface of the Meter when servicing. Do not use abrasives or solvents when cleaning the meter; doing so can cause corrosion, damage and can potentially compromise the meter's safety features.
- The Meter is suitable for indoor use only.
- Turn the Meter off when it is not in use and remove the battery when the meter is to be stored or unused for long periods.
- Keep track of the battery age and replace batteries when necessary. Leaking batteries can damage the meter.

## Description

---

### Meter Description (front)

- 1 Transformer Jaw
- 2 Jaw Open Trigger
- 3 LCD Display
- 4 Voltage detector sensor
- 5 Voltage detector alarm light
- 6 Function dial switch (HOLD button)
- 7 Push-buttons (see list below)
- 8 L1, L2, L3 Input Terminal
- 9 PC Interface cable jack

**Note:** Battery compartment located on back of instrument

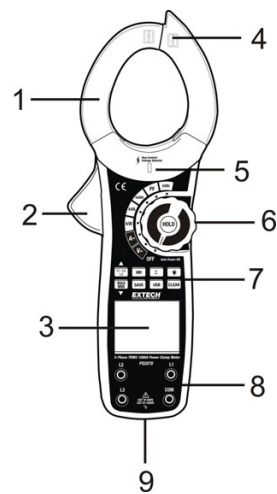





Figure 1

## Display icons Description

<b>USB</b>	PC Interface
<b>L1</b>	Phase 1
<b>L2</b>	Phase 2
<b>L3</b>	Phase 3
<b>h</b>	Hours
<b>m</b>	Minutes
<b>S</b>	Seconds
<b>PF</b>	Power Factor
<b>KVA</b>	Active power
<b>KWh</b>	Kilowatt hours
<b>Hz</b>	Frequency(Hertz)
<b>PG</b>	Phase angle
<b>KVAr</b>	Reactive power
<b>Σ W</b>	Sum of Wattage measurements
	Low Battery
<b>MAX-MIN</b>	Maximum and Minimum readings
	Analog Bar Graph
<b>CLR</b>	Clear Data
<b>-</b>	Negative symbol
	High voltage symbol
<b>AC</b>	AC voltage or current
<b>RCL</b>	Recall stored data
<b>MEM</b>	Data storage
<b>FULL</b>	Data logger is full
<b>HOLD</b>	Data hold is active

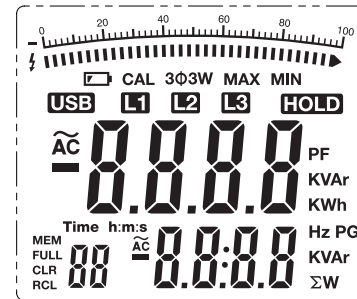



Figure 2

## Push-button Description



Figure 3

<b>L1-L2-L3</b>	Press <b>L1-L2-L3</b> to step through the first phase, second phase, third phase, and the sum of the watt measurements. Press and hold <b>L1-L2-L3</b> for at least two (2) seconds to enter 3P3W mode.
<b>MR</b>	Press once to enter the Memory Recall mode, the <b>MR</b> icon will appear and the meter will beep. Use the arrow buttons as described directly below to step through the 99-reading internal memory.
<b>Σ</b>	In the Active power mode (kW dial position), the <b>Σ</b> button is used to sum the multiple measurements when testing 3 phase systems. Refer to the Active Power Measurement section of this User Guide for details on using the sum button.
	Press the backlight button to switch the backlight ON. The backlight will automatically switch OFF after 20 seconds. Press the button to turn the backlight off manually.
<b>MAX-MIN</b>	Press to view the highest (MAX) reading; press again to view the lowest (MIN) reading. This feature applies to voltage, current, active power and apparent power ranges only. While the MAX or MIN icon is displayed, only the highest or lowest reading is shown.
<b>SAVE</b>	Press <b>SAVE</b> momentarily to store a single reading; the Meter will beep. The index number shown on the left side of the secondary display will increase with each stored reading. The maximum number of data points is 99. The Meter displays the <b>FULL</b> icon when the memory is filled.
<b>USB</b>	Measurement data will be sent to the PC when meter is connected to the PC and the supplied software and driver is installed and running.
<b>CLEAR</b>	In the Active Energy mode, press and hold <b>CLEAR</b> for at least one (1) second to restart the elapsed timer from zero. For all other ranges, press and hold <b>CLEAR</b> for at least one (1) second to clear (erase) the 99-reading internal memory.
<b>▼/▲</b>	When stepping through the sum of power measurements, use the <b>▼/▲</b> buttons to switch the display from active power/reactive power to power factor/apparent power modes. In the MR mode, use <b>▼/▲</b> to scroll through the meter's internal 99 reading memory.
<b>HOLD</b>	Press <b>HOLD</b> to enter the Hold mode, the <b>H</b> will appear and the Meter will beep and the displayed reading will freeze. Press <b>HOLD</b> again to exit the Hold mode, the Meter will beep and the <b>H</b> icon will switch off.

## Operation

**NOTES:** Read and understand all **Warning** and **Caution** statements in this operation manual prior to using this meter. Set the function switch to the OFF position when the meter is not in use.

### Non-Contact Voltage Detector

**⚠ WARNING:** Risk of electrocution. Before use, always test the voltage detector on a known live circuit to verify proper operation.

1. Rotate the function switch to any measurement position.
2. Place the detector probe tip on the conductor or voltage source to be tested.
3. The red LED light on the front of the meter (just below the clamp jaw) will illuminate when voltage is detected.

**Note:** The conductors in electrical cord sets are often twisted. For best results, move the probe tip along a length of the cord to assure placing the tip close to the live conductor.

**Note:** The detector is highly sensitivity. Static electricity or other sources of energy may randomly trip the sensor. This is normal operation.

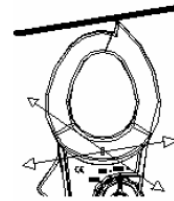

Figure 4

## AC Voltage Measurements

### AC voltage on Main Display (Frequency on Secondary Display)

The AC Voltage ranges are: 100V, 400V and 750V

The frequency range is: 50Hz~60Hz

Single phase - connect the L1 test lead to the power wire and connect the COM lead to the neutral wire.

3-Phase 4-wire - connect the COM lead to the neutral conductor.

3-Phase 3-Wire - connect the COM lead to an earth ground.

1. Insert the black test lead into the meter's COM input terminal.
2. Connect the other end of the black (COM) test lead to the corresponding neutral wire (single phase and 3P4W) or for a 3P3W to one of the phase wires.
3. **Single phase:** Insert a test lead into L1 and connect it to the Power wire.  
**3Φ4Wire:** Connect all 3 leads (red -L1), yellow-L2, and blue-L3) into the L1, L2, & L3 meter input terminals and connect each to a corresponding phase wire. (see fig 5)  
**3Φ3Wire:** Connect L1 and L3 to the meter and then connect L1 to one phase wire and L3 to the remaining phase wire.
4. Turn the rotary function switch to the VAC position to select Voltage + Frequency mode.
5. Press the L1-L2-L3 button to select the appropriate phase, the display shows the corresponding phase symbol on the display. L1 is the first (single) phase, L2 is the second phase, and L3 is the third phase.
6. The main display indicates the True RMS voltage and the secondary display indicates the Frequency value.
7. To monitor the highest (MAX) and lowest (MIN) readings, press the MAX-MIN button. The LCD will now display 'MAX' and the meter will indicate only the maximum AC voltage True RMS value.
8. Press MAX-MIN again and the LCD will display 'MIN' and the meter will indicate only the minimum AC voltage True RMS value.
9. Press MAX-MIN again to exit the MAX-MIN mode and return to displaying the real-time AC voltage True RMS value.
10. The display indicates 'OL' when the input voltage is greater than 750V rms.

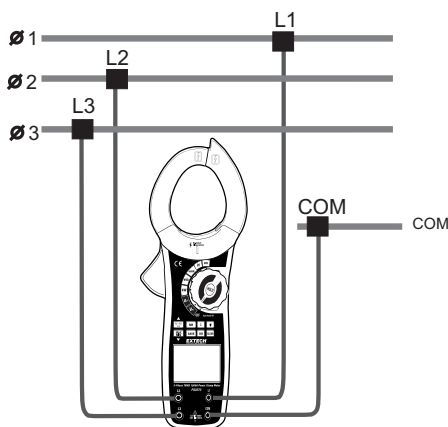

Figure 5 (3P4W)

**Note:** When the measurement session has been completed, disconnect the test leads from the circuit under test and remove the test leads from the meter's input terminals.



## AC Current Measurements

### Important Clamp Measurement Considerations

Place the conductor under test at the center of the transformer jaw for the best measurement accuracy. This meter can only measure one conductor at a time. Do not clamp two or more conductors. Clamp the wire so that the FACE of the meter is towards the source of power.

To measure AC Current, connect the meter as follows:

1. Set the Rotary switch to the AAC.
2. Clamp around one conductor.
3. The dual display indicates the AC current True RMS value (main display)  
Note: if the voltage leads are connected, the TRMS AC voltage value will be displayed on the secondary display.
4. To monitor the highest (MAX) and lowest (MIN) readings, press the **MAX-MIN** button. The LCD will now display 'MAX' and the meter will indicate only the maximum TRMS AC Current value.
5. Press **MAX-MIN** again and the LCD will display 'MIN' and the meter will indicate only the minimum TRMS AC Current value.
6. Press **MAX-MIN** again to exit the MAX-MIN mode and return to displaying the real-time TRMS AC Current value.
7. The display indicates 'OL' when the input current is greater than 1000A.

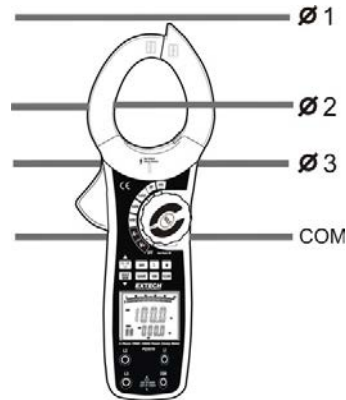

Figure 6

**Note:** When the measurement session has been completed, disconnect the test leads from the circuit under test and remove the test leads from the meter's input terminals.

## Power Measurements

### Active, Reactive, and Apparent Power Measurements

There are three displays modes in this section as detailed in this section:

- **kW** Active Power on Main Display (Phase Angle on Secondary Display)
- **kVA** Apparent Power on Main Display (Reactive power on Secondary Display)
- **kVAR** Reactive Power on Main Display (Apparent power on Secondary Display)

 **WARNING:** To avoid meter damage and personal injury do not measure RMS signals greater than 750VAC or 1000AAC.

#### NOTES:

- The maximum and minimum values are not available in this mode.
- The summing of wattage values is only available in the **KW** mode.
- When the measurement session has been completed, disconnect the test leads from the circuit under test and remove leads from the meter's input terminals.

• Power connections and measurements shown for

3-Phase 4-wire  
3-Phase 3-wire  
Single and Split phase

### 3-Phase, 4-Wire Power Measurements

1. Connect the four voltage leads as shown in Figure. 7
2. Clamp the transformer jaw around the power conductors connected to the L1 voltage lead.
3. Set the meter to **kW**. The dual display shows the Active power kW value and the Phase Angle (PG) value.
4. Press the **L1-L2-L3** button to choose the first phase **L1** (see figure 8).
5. Press the  $\Sigma$  button to save and sum the measured value for **L1**. (see Figure 8)

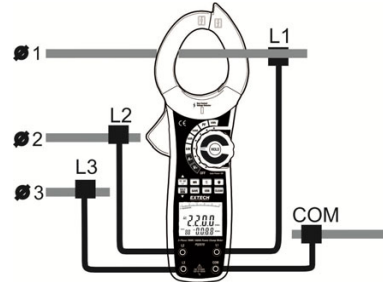
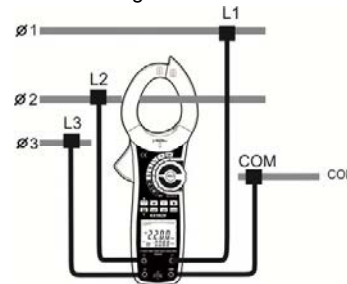
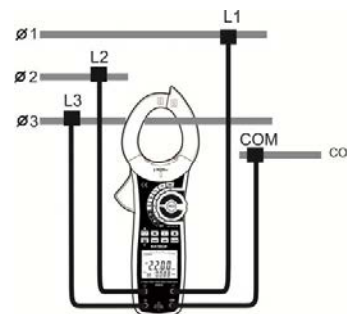

Figure 7

6. Move the clamp jaw to the power conductor connected to the L2 voltage test lead.
7. Press the **L1-L2-L3** button to choose the first phase **L2**. The primary display shows the kW for phase L1 and the secondary display shows the Phase angle (PG).
8. Press the  $\Sigma$  button to save and sum the measured value for **L2**. (figure 8). The primary display shows the kW for phase L2 and the secondary display shows the Phase angle (PG).



9. Move the clamp jaw to the power conductor connected to the L3 voltage test lead.
10. Press the **L1-L2-L3** button to choose the first phase **L3**. The primary display shows the kW for phase L3 and the secondary display shows the Phase angle (PG).
11. Press the  $\Sigma$  button to save and sum the measured value for **L3**. (figure 8)
12. After recording the kW power measurement value for the third phase, press and Hold the  $\Sigma$  button for 1 second to display the 3 phase sum of **kW** on the main display and **kVA** on the secondary display. (figure 9)
13. Press the  $\blacktriangle$  button to display the 3 phase sum of **KVAR** on the main display.
14. Press and Hold the  $\Sigma$  button for 1 second to return to normal operation.



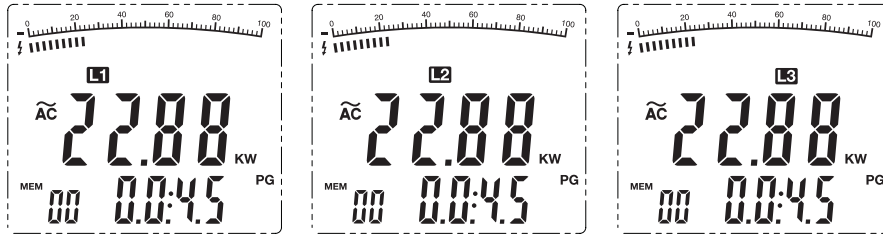

Figure 8

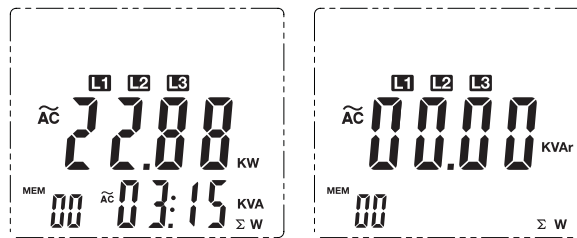

Figure 9

### 3-Phase, 3-Wire Power Power Measurements

Note:

When measuring 3 phase / 3-wire systems, hold down the **L1-L2-L3** button for 5 seconds to display the **3 $\phi$ 3w** icon. (Press and hold the **L1-L2-L3** button again for 5 seconds to exit the 3 phase/3-wire mode back to the default 3 $\phi$ 4wire mode).

Connect the Meter as shown in Figure 10.

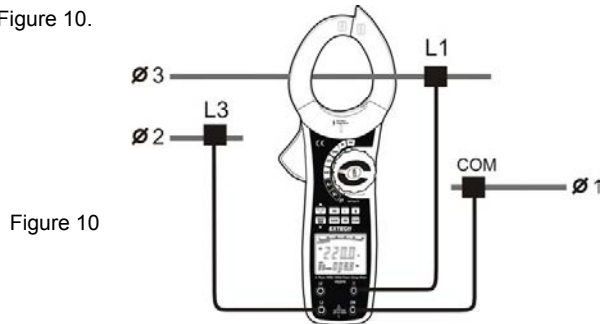

1. Insert the Red (L1) and Blue (L3) test leads into the **L1, L3** meter input terminals and connect these to 2 separate phases of the circuit under test as shown in Figure 10.
2. Insert the black test lead into the **COM** input terminal on the meter and connect it to the last remaining wire of the 3 phase 3-wire system under test.  
Note Skip the second (L2) connection.
3. Set the Rotary switch to the **KW** position.
4. Press the **L1-L2-L3** button to choose the first phase **L1** (see figure 8). The primary display shows the kW for phase L1 and the secondary display shows the Phase angle (PG).
5. Press the  $\Sigma$  button to save and sum the measured value for **L1**. (see Figure 8)
6. Move the clamp jaw to the power conductor connected to the L3 voltage test lead.
7. Press the **L1-L2-L3** button to choose the first phase **L3**. The primary display shows the kW for phase L3 and the secondary display shows the Phase angle (PG).
8. Press the  $\Sigma$  button to save and sum the measured value for **L3**. (figure 8)
9. After recording the kW power measurement value for the L3 phase, press and Hold the  $\Sigma$  **button** for 1 second to display the 3 phase sum of **kW** on the main display and **kVA** on the secondary display. (figure 9)
10. Press the  $\blacktriangle$  button to display the 3 phase sum of **kVAR** on the main display.
11. Press and Hold the  $\Sigma$  **button** for 1 second to return to normal operation

For Figure 9: for 3-wire  $\Sigma W = W1 + W3$

## Single Phase and Split Phase Power Measurements

1. 1. Clamp the transformer jaw and around the Power wire.
2. 2. Connect the L1 test lead to this Power wire.
3. 3. Connect the COM test lead to the neutral/com wire.
4. 4. Set the Rotary switch to the KW, kVA or kVAR position
5. 5. Press the L1-L2-L3 button to choose phase L1.
6. 6. The display will show the power value.

The display will show the power value.

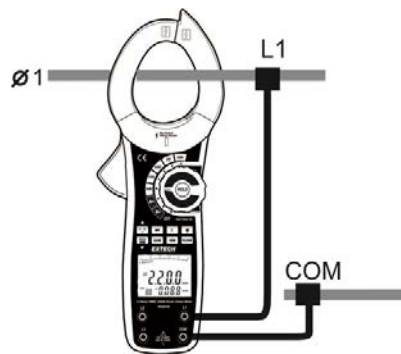

Single Phase

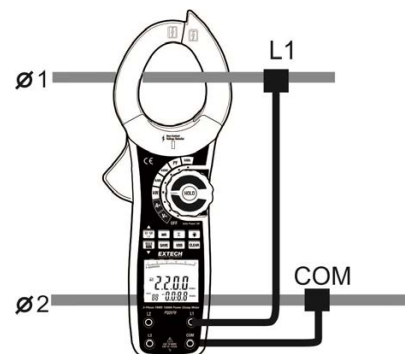

Split Phase

## Power Factor



**WARNING:** To avoid meter damage and personal injury do not measure RMS signals greater than 750VAC or 1000AAC.

**Note:** The MAX/MIN feature is not operational when measuring power factor.  
A minimum of 10 amps is required for measuring an accurate power factor.

### Power Factor measurement

1. Set the Rotary switch to the PF position.
2. 3-phase - Connect the meter as shown in Fig. 7 (3P4W) or Fig. 10 (3P3W)  
Single phase – Connect the L1 test lead to the Power wire and COM to the neutral wire.
3. Clamp around the phase to be measured. (Power wire for Single phase).
4. Press the L1-L2-L3 button to select the conductor that is clamped. (Fig.11)
5. The dual display indicates the power factor (PF) in the main display and the phase angle (PG) in the secondary display

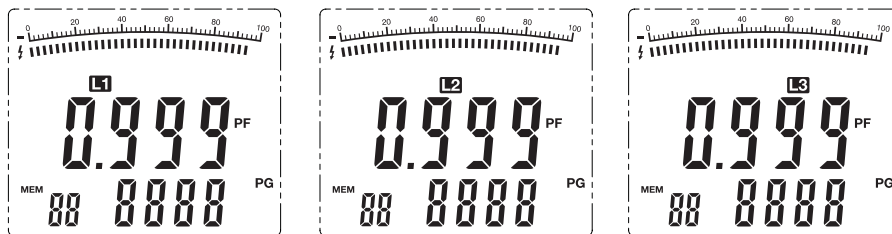

Figure 11

## Kilowatt Hours

**⚠ WARNING:** To avoid meter damage and personal injury do not measure RMS signals greater than 750VAC or 1000AAC.

### To test Kilowatt hours, connect the Meter as follows:

1. Set the Rotary switch to the **kWh** position.
2. Connect the meter as shown in Fig. 7 (3P4W) or Fig. 10 (3P3W) for 3-phase connections. Single Phase – connect the L1 test lead to the Power wire and COM lead to Neutral.
3. Clamp around the phase to be measured. (Power wire for single phase)
4. Press the L1-L2-L3 button to select the conductor clamped. (L1 for single phase)
5. Press and Hold the CLEAR button for 1 second to reset the clock to 0.
6. The measured kWh value is displayed in the main display and the elapsed time in the secondary display. (Fig. 12)

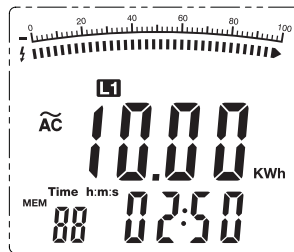

Figure 12

7. Press **HOLD** to read a particular (time) kWh value. The reading and the elapsed time values will be locked, but the continuous measuring time will be tracked and accumulated.
8. After noting the data, press **HOLD** again to perform a continuous measurement.
9. The kWh value will continue accumulate and the measuring time jumps to the present measuring time.
10. When the measuring time exceeds 24 hours or if the Meter is switched to another measurement mode, the active energy measurement will stop.
11. The maximum active energy is 9999kWh. **OL** will be displayed when the reading exceeds this limit.
12. The **MAXMIN** feature is not available when measuring active energy.
13. Press and hold the **CLEAR** button for 1 second to reset the time and energy value.



### **LCD Backlight Button**

The LCD is equipped with backlighting for easier viewing, especially in dimly lit areas. Press the backlight button to switch the backlight ON. The backlight will automatically switch OFF after approx. 20 seconds. Press the button to turn the backlight off manually

### **Automatic Power OFF**

In order to conserve battery life, the meter will automatically turn off after approximately 25 minutes. To turn the meter on again, turn the function switch to the OFF position and then to the desired function position.

### **PC Interface**

The meter connects to a PC via the supplied infrared to USB interface cable. The infrared side of the cable connects to the port at the bottom of the meter and the USB end connects to the PC.

The supplied software permits the user to collect up to 50,000 readings as they are taken. The readings can be displayed as a list or graph within the software environment or exported to a spreadsheet.

Instructions for use of the PC interface and software are supplied on the software disk included in the meter package.

### **True RMS Measurement and Average Value Measurements**

- True RMS measures the effective value of sine-wave and non-sine wave input signals
- Average measurements represent the mean value of sine wave signals
- The clamp Meter uses the following formulas:

$$KW = KVA \times \cos\theta$$

$$KVA = \sqrt{KW^2 + KVAr^2}$$

$$KVAr = KVA \times \sin\theta$$

## ***Maintenance***

---

**WARNING:** To avoid electrical shock, disconnect the meter from any circuit, remove the test leads from the input terminals, and turn OFF the meter before opening the case. Do not operate the meter with an open case.

### **Cleaning and Storage**

Periodically wipe the case with a damp cloth and mild detergent; do not use abrasives or solvents. If the meter is not to be used for 60 days or more, remove the battery and store it separately.

### **Battery Replacement**

1. Remove the Phillips head screw that secures the rear battery door
2. Open the battery compartment
3. Replace the 9 Volt battery
4. Secure the battery compartment
5. Dispose of batteries responsibly and according to all applicable laws

## Electrical Specifications

### Current, Voltage, and Frequency

Function	Range & Resolution	Accuracy (% of reading + digits)	Overload Protect	Input Impedance	Frequency range
AC Current	40.0 AAC	± (2% + 5d)	1000A	N/A	50-60Hz
	100.0 AAC				
	400.0 ADC				
	1000 ADC				
AC Voltage	100.0VAC	± (1.2% + 5d)	750V rms	10MΩ	50-120Hz
	400.0 VAC				
	750.0VAC				
Frequency	50 to 200Hz	± (0.5% + 5d)			

**Active Power (kW)**  $W = V \times A \times \cos \theta$

Current / Voltage		Voltage Ranges		
		100V	400V	750V
Current Ranges	40A	4.00KW	16.00KW	30.00KW
	100A	10.00KW	40.00KW	75.00KW
	400A	40.00KW	160.0KW	300.0KW
	1000A	100.0KW	400.0KW	750.0KW
Accuracy		±(3%+5)		
Resolution		<1000KW: 0.01KW; 100kW: 0.1KW		

**Apparent Power (kVA)  $VA = V \times A$**

Current / Voltage		Voltage Ranges		
		100V	400V	750V
Current Ranges	40A	4.00KVA	16.00KVA	30.00KVA
	100A	10.00KVA	40.00KVA	75.00KVA
	400A	40.00KVA	160.0KVA	300.0KVA
	1000A	100.0KVA	400.0KVA	750.0KVA
Accuracy		±(3%+5)		
Resolution		<1000KVA: 0.01KVA; 100kW: 0.1KVA		

**Reactive Power (kVAR)  $Var = V \times A \times \text{SIN } \theta$**

Current / Voltage		Voltage Ranges		
		100V	400V	750V
Current Ranges	40A	4.00KVAr	16.00KVAr	30.00KVAr
	100A	10.00KVAr	40.00KVA	75.00KVAr
	400A	40.00KVAr	160.0KVAr	300.0KVAr
	1000A	100.0KVAr	400.0KVAr	750.0KVAr
Accuracy		±(3%+5)		
Resolution		<1000KVAr: 0.01KVAr; 100kW: 0.1KVAr		

**Power Factor**  $PF = W / VA$ 

Range	Accuracy	Resolution	Measurement Considerations
0.3~1 (capacitive or inductive)	$\pm 0.022$	0.001	Minimum current 10A Minimum voltage 45V
0.3~1 (capacitive or inductive)	For reference only		Current less than 10A or Voltage less than 45V

**Phase Angle**  $PG = a \cos (PF)$ 

Range	Accuracy	Resolution	Measurement Notes
0° ~90° (capacitive or inductive)	$\pm 2^\circ$	1°	Minimum current 10A Minimum voltage 45V
0° ~90° (capacitive or inductive)	For reference only		Current less than 10A Voltage less than 45V

**Kilowatt Hours (kWh)**

Range	Accuracy	Resolution
1~9999kWh	$\pm(3\%+2)$	0.001kWh

## ***General Specifications***

---

<b>Clamp jaw opening</b>	57mm (2-1/4") approx.
<b>Display</b>	Dual 4-digit (9999 counts) backlit LCD
<b>Bargraph</b>	100 units
<b>Low Battery indication</b>	Battery symbol is displayed
<b>Over-range indication</b>	'OL' display
<b>Internal Reading Memory</b>	99 readings can be stored, recalled, and cleared.
<b>External PC Memory</b>	50,000 readings can be recorded on a connected PC running the supplied PC software. Readings can be exported to a spreadsheet.
<b>Measurement rate</b>	2 readings per second, nominal
<b>Input Impedance</b>	10M $\Omega$ (VAC)
<b>AC bandwidth</b>	50 to 200Hz (AAC and VAC)
<b>AC response</b>	True rms (AAC and VAC)
<b>Operating Temperature</b>	5°C to 40°C (41°F to 104 F)
<b>Storage Temperature</b>	-20°C to 60°C (-4°F to 140°F)
<b>Operating Humidity</b>	< 80% up to 31°C (87°F) decreasing linearly to 50% at 40°C (104°F)
<b>Storage Humidity</b>	< 80%
<b>Operating Altitude</b>	2000meters (7000ft) maximum
<b>Battery</b>	One (1) 9V Battery (NEDA 1604)
<b>Auto power OFF</b>	After approx. 25 minutes
<b>Dimensions &amp; Weight</b>	292 x 95 x 38mm (11.5 x 3.75 x 1.5"); 522g (18.4 oz)
<b>Safety</b>	For indoor use and in accordance with the requirements for double insulation to IEC1010-1 (2001): EN61010-1 (2001) Overvoltage Category IV 600V and Category III 1000V, Pollution Degree 2

**Copyright © 2015 FLIR Systems, Inc.**

All rights reserved including the right of reproduction in whole or in part in any form