

Operating Instructions for Paddle Flow Monitor

Model: PSR-..., PSE-...



1. Contents

1. Contents.....	2
2. Note	3
3. Instrument Inspection.....	4
4. Regulation Use	4
5. Operating Principle.....	5
6. Use in Hazardous Areas (PSx-2)	5
6.1. Preamble	5
6.2. General information on explosion protection.....	5
6.3. Commissioning, installation, operation	8
6.4. Maintenance, servicing	9
6.5. Troubleshooting	10
6.6. Disposal	11
6.7. Identification of the flow monitor (nameplate)	11
7. Mechanical Connection.....	12
8. Electrical Connection	13
9. Limit Switches	13
10. Maintenance	16
11. Technical Information.....	17
11.1. General	17
12. Order Codes	19
13. Recommended Spare Parts.....	22
14. Dimensions	23
15. Disposal	24
16. EU Declaration of Conformance	25
17. UK Declaration of Conformity.....	27
18. EU Declaration of Conformance ATEX	28
19. ATEX Certificate.....	30
20. IECEx Certificate.....	35

2. Note

Please read these operating instructions before unpacking and putting the unit into operation. Follow the instructions precisely as described herein.

The devices are only to be used, maintained and serviced by persons familiar with these operating instructions and in accordance with local regulations applying to Health & Safety and prevention of accidents.

Machine guidelines 2006/42/EC

No CE mark

By usage in machines, the measuring unit should be used only when the machines fulfill the EC-machine guidelines.

as per PED 2014/68/EU

	Pipe	
	Table 8 Group 1 dangerous fluids	Table 9 Group 2 non-dangerous fluids
PSR-.. (1/4" - 1")	Art. 4, § 3	Art. 4, § 3
PSR-132B and PSR-140B	not deliverable	Art. 4, § 3
PSR-232B and PSR-240B	Cat. II	Art. 4, § 3

3. Instrument Inspection

Instruments are inspected before shipping and sent out in perfect condition. Should the damage to a device be visible, we recommend a thorough inspection of the delivery packing. In case of damage, please inform your parcel service/ forwarding agent immediately, since they are responsible for damages during transit.

Scope of delivery:

- Paddle Flow Monitor Model: PSR-... / PSE-..

4. Regulation Use

Series PSR and PSE are used to monitor liquid flow. Instruments are provided with an adjustable limit switch. Only low viscosity fluids that are compatible with the material combination chosen are allowed to be monitored. If using higher viscous media, large deviations in the specified switching range will occur.

The instruments are relatively insensitive to dirt, however large particles may block the paddle, leading to erroneous alarm conditions; likewise, ferritic particles may deposit on the magnet and lead to faulty operation. In case of doubt, please contact the manufacturer.

5. Operating Principle

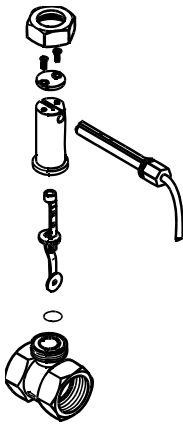

The KOBOLD flow monitors of series PSE and PSR are used where economical, reliable flow monitors are indicated. Depending on the flow velocity respectively flow rate, the baffle plate is deflected and moves the permanent magnet via the balance arm into the switching range of the reed contact mounted outside of the flow media.

The flat spring, which also serves as a support for the balance arm, forces the baffle plate back to its rest position when there is no flow. KOBOLD baffle plate flow monitors are supplied completely assembled with fitting up to nominal size 40, or for larger nominal pipe sizes - supplied without a pipe length for direct insertion into standard T pieces or fittings. The sealing takes place via PTFE tape.

6. Use in Hazardous Areas (PSx-2)

6.1. Preamble

This excerpt from the operating instructions only represents the ex-relevant aspects. It is adopted in the same or analogous form in the original operating instructions; Textual changes are permitted; the ex-relevant statements remain. To ensure functionality and for your own safety, please read the enclosed operating instructions carefully before starting the installation. If you have any questions, please contact. It applies with the original operating instructions. When evaluating the product, the following standard issues were taken into account:

- a) IEC 60079-0:2017 Ed. 7.0 / EN IEC 60079-0:2018 Explosive atmospheres – Part 0: General Requirements
- b) IEC 60079-11:2011 Ed. 6 + Cor.:2012 / EN 60079-11:2012 Explosive atmospheres – Part 11: Equipment protection by intrinsic safety “i”
- c) EN 50303:2000 Group 1, category M1 equipment intended to remain functional in atmospheres endangered by firedamp and/or coal dust

6.2. General information on explosion protection

The KOBOLD flow monitors types PSR and PSE are used wherever reliable flow monitoring is required.

Depending on the flow velocity or flow rate, the baffle plate is deflected and moves the permanent magnet via the balance beam into the response area of the reed contact located outside the flow medium.

Due to the force of the leaf spring, which also serves as a holder for the balance beam, the baffle plate is returned to its rest position if the flow fails. The KOBOLD baffle plate flow monitors are supplied complete with a pipe section up to a nominal size of 40. For larger pipe sizes, the devices are supplied without a pipe section for direct installation and are screwed into commercially available T-pieces or reducers. The seal is made with PTFE tape.

The flow monitor is intended for commercial systems and may only be used in accordance with the information in the technical documentation and the information on the nameplate. It is operated exclusively together with certified products via an intrinsically safe circuit. They correspond to the applicable standards and regulations.

The installation regulations (e.g. EN 60079-14) for systems in potentially explosive areas must be observed.

Permitted use

- The intrinsically safe flow monitor can be used as follows, taking the certified parameters into account:
 - In Zone 0 (Gas-Ex, Cat. 1G) in explosion groups IIA, IIB and IIC
 - In Zone 20 (Dust-Ex, Cat. 1D) in explosion groups IIIA, IIIB and IIIC
 - In Zone 1 (Gas-Ex, Cat. 2G) in explosion groups IIA, IIB and IIC
 - In Zone 21 (Dust-Ex, Cat. 2D) in explosion groups IIIA, IIIB and IIIC
 - In Zone 2 (Gas-Ex, Cat. 3G) in explosion groups IIA, IIB and IIC
 - In Zone 22 (Dust-Ex, Cat. 3D) in explosion groups IIIA, IIIB and IIIC
- The qualification with regard to the surface temperature is T4 / T3; for all gases, vapors, mists and dusts with an ignition temperature $\geq 110\text{ °C}$ / $\geq 150\text{ °C}$, the products are not an ignition source.
- The permissible ambient temperature range extends from $-20\text{ °C} \leq T_a \leq 70\text{ °C}$ in the standard version; up to 110 °C for the high temperature version.

6.2.1. Electrical parameters when used in all zones, except for zone 20

- $U_i = 60\text{ V AC/DC}$
- $I_i = 2\text{ A}$
- $P_i = 40\text{ W} / 20\text{ VA}$
- $L_i = \text{negligible}$
- $C_i = \text{negligible}$
- Ambient temperature range of the standard version PSx-21:
 $-20\text{ °C} \leq T_a \leq 70\text{ °C} \rightarrow T4 / T110\text{ °C}$
- Ambient temperature range of the high temperature version PSx-22:
 $-20\text{ °C} \leq T_a \leq 110\text{ °C} \rightarrow T3 / 150\text{ °C}$

6.2.2. Electrical parameters when used in Zone 20

- $U_i = 30 \text{ V AC/DC}$
- $I_i = 0.25 \text{ A}$
- $P_i = 650 \text{ mW @ } T_a 70 \text{ }^\circ\text{C}, 500 \text{ mW @ } T_a 110 \text{ }^\circ\text{C}$
- $L_i = \text{negligible}$
- $C_i = \text{negligible}$
- Ambient temperature range of the standard version: $-20 \text{ }^\circ\text{C} \leq T_a \leq 70 \text{ }^\circ\text{C} \rightarrow T_4 / T_{135} \text{ }^\circ\text{C}$
- Ambient temperature range of the high temperature version: $-20 \text{ }^\circ\text{C} \leq T_a \leq 110 \text{ }^\circ\text{C} \rightarrow T_4 / T_{135} \text{ }^\circ\text{C}$

6.2.3. General requirements

6.2.4.1 Intended Use

- To ensure safe operation, the products may only be used in accordance with the information in the assembly instructions. When using the device, the legal and safety regulations required for the respective application must also be observed. This also applies analogously to the use of accessories.
- If the instructions given in this excerpt are not observed or if the product is improperly handled, our liability is void. In addition, the warranty does not apply to products and spare parts.
- The products are not safety elements in the sense of their intended use.
- Only original parts from the manufacturer may be used.
- Flammable media within the flow monitor must not be heated to above 80% of their ignition temperature in zone 0 or 1 without taking special measures.

6.2.4.2 General safety information

The flow monitor corresponds to the state of the art and is operationally safe. The flow monitor can pose a residual risk if it is used and operated improperly by untrained personnel. Every person who is entrusted with the installation, commissioning, maintenance or repair of the flow monitor must have read and understood the assembly instructions and in particular the safety instructions.

- When selecting a product and using it as intended, follow the general rules of technology.
- All connected electrical and mechanical equipment must be suitable for the respective application.
- Observe the information in these operating instructions as well as the conditions of use and permissible data that appear on the imprints / nameplates of the respective products.
- It must be ensured that only the product types of protection that correspond to the zones are installed!
- The product is only approved for appropriate and intended use in a normal industrial atmosphere. Immersion in liquids is not permitted.
- It must be ensured that no falling objects can hit the product. If there is a risk of impact sparks, external housing parts made of light metal must be installed in a protected manner.
- The operator must ensure lightning protection for the entire system in accordance with local regulations.

- h) It is the responsibility of the installer to ensure that the flow monitor functions properly in conjunction with the individual evaluation devices and that it is approved for the intended purpose.
- i) The intrinsically safe connection must be made using approved / tested evaluation devices, which may have to be equipped with suitable Zener barriers or switching amplifiers.

6.3. Commissioning, installation, operation

Depending on the IP degree of protection, the time for cleaning the equipment (dust deposits) must be specified. Other important facts:

- a) The product may only be put into operation in intrinsically safe circuits in the zones defined in Section 2 in Section "Permitted Use" by specialists with a qualification similar to a qualified person in accordance with TRBS 1203.
- b) The products may only be used in a normal industrial atmosphere. If aggressive substances are present in the air, the manufacturer should always be consulted. The products must be appropriately protected in adverse environmental conditions.
- c) The operation of the product is only permitted in the completely assembled and undamaged housing. In the event of possible damage, the operator may have to consider the spread of zones; In addition, operation is not permitted if the housing is damaged.
- d) The ambient conditions specified in the operating instructions must be strictly adhered to and appropriately protected against adverse ambient conditions.
- e) The mechanical flow monitor may only be operated when it is completely filled. Exceptions according to the operator's risk assessment are only permitted for start-up and shutdown.
- f) Thermal radiation from third-party products / components must be taken into account.
- g) The flow monitor must be protected against inadmissible ingress of liquids and / or contamination.
- h) The contact must be protected against UV light.
- i) Stuck parts (e.g. due to frost or corrosion) must not be loosened with force in the presence of an explosive atmosphere. Icing must therefore be avoided.
- j) The flow monitor may only be exposed to low vibrations, see also IEC 34-14.
- k) A direct electrostatic discharge of high energy onto the equipment is not permitted (usually cannot be generated by human contact). To ensure that electrostatic charges are discharged, the national requirements must be taken into account.
 - l) In particular, isolated capacities must be prevented.
 - m) All construction parts must be connected to one another using metal.
 - n) In zones 20, 21 and 0, the connection cables must be protected against electrostatic charges.
 - o) Equalizing currents must not be routed through the metallic structures.
- p) Only Zener barriers or switching amplifiers whose output circuits are approved / tested for use in an explosive atmosphere may be used. In Europe, use in Zone 1 requires an EC type-examination certificate for the

equipment in question, which is issued by a body designated for explosion protection.

- a) The voltage of the supply units must be less than or equal to the voltage U_i of the flow monitor.
 - b) The total current I_o of the supply devices must be less than or equal to the current I_i of the flow monitor.
 - c) The ignition limit curves from EN 60079-11 must be taken into account in Zone 2 without a safety factor and must be observed during installation. In Zone 1, the safety factor 1.5 must be used. A control drawing (system description) to be created by the installer / operator is required for the installation of the intrinsically safe circuit.
 - d) Equipotential bonding must be established along the intrinsically safe circuit if the power is supplied via an earthed source.
- q) The certificates must be taken into account, including the special conditions stipulated therein.
- r) Within the potentially explosive area, assembly may only be carried out in accordance with the locally applicable installation regulations. The following conditions must be observed (incomplete):
- a) Installation and maintenance may only be carried out in an explosion-free atmosphere and in compliance with the regulations applicable in the country of the operator.
 - b) Additional precautions must be taken if the presence of hydrogen sulfide, ethylene oxide and / or carbon monoxide is to be expected: These substances have a very low ignition energy!
 - c) If these substances are present and if a substance of explosion group IIC is present and an explosive atmosphere is likely to be present, only non-sparking tools may be used!
 - d) The flow monitors must not be used in systems with cathodic corrosion protection; in borderline cases, consult the manufacturer.
 - a) Particular care must be taken to ensure that no stray currents (e.g. generated by motors that are operated on frequency converters, welding systems and / or cathodic corrosion protection systems) are passed through the flow monitor.

6.4. Maintenance, servicing

Definition of terms according to IEC 60079-17:

Maintenance and repair: A combination of all activities that are carried out to keep an object in a condition or to bring it back into a condition that meets the requirements of the relevant specification and ensures the execution of the required functions.

Inspection: An activity that involves the careful examination of an object with the aim of making a reliable statement about the condition of this object, without dismantling or, if necessary, with partial dismantling, supplemented by measures such as B. measurements is carried out.

Visual inspection: A visual inspection is an inspection in which visible defects are found without the use of access devices or tools, for example missing screws.

Close-up inspection: An inspection that, in addition to the aspects of the visual inspection, identifies defects such as loose screws that can only be removed through the use of access devices, e.g. B. Steps (if necessary), and tools can be identified. For close-up tests, a housing does not usually need to be opened or the equipment needs to be de-energized.

Detailed inspection: An inspection in which, in addition to the aspects of close-up inspection, defects such as loose connections, which can only be identified by opening housings and / or, if necessary, using tools and testing equipment, are identified.

- a) Maintenance measures may only be carried out by qualified persons.
- b) Only those accessories may be used in potentially explosive areas that meet all the requirements of the European directives and national legislation.
- c) Maintenance measures with dismantling of the flow monitor may only be carried out in an explosion-free atmosphere.
- d) Components may only be replaced with original spare parts that are also approved for use in Ex areas. Repairs only by the manufacturer or specialist workshop.
- e) The products must be regularly serviced and cleaned in the Ex area. The intervals are determined by the operator in accordance with the environmental stresses on site.

	Activity	Visual inspection monthly	Close-up inspection every 6 months	Detailed examination every 12 months
1	Visual inspection of the flow monitor for damage and remove dust deposits	•		
2	Check for integrity and function			•
3	Examination of the entire system	In the operator's area of responsibility		

6.5. Troubleshooting



No changes may be made to products that are operated in connection with potentially explosive areas. Repairs to the product may only be carried out by specially trained and authorized specialists.

6.6. Disposal



The packaging and used parts must be disposed of in accordance with the regulations of the country in which the product is installed.

6.7. Identification of the flow monitor (nameplate)

6.7.1. Marking for the standard version

	Kobold Messring GmbH Nordring 22-24 D 65719 Hofheim	www.kobold.com BVS 09 ATEX E102 / IECEx BVS 09.0044
	PS*-21** * *** * * SN: K0000000000001234 -20°C < Ta < 70°C	YoC: 2021  0158

6.7.2. Marking for the high temperature version

	Kobold Messring GmbH Nordring 22-24 D 65719 Hofheim	www.kobold.com BVS 09 ATEX E102 / IECEx BVS 09.0044
	PS*-22** * *** * *H SN: K0000000000001234 -20°C ≤ Ta ≤ 110°C	YoC: 2021  0158

7. Mechanical Connection

Before installation

- Please check that the actual flow matches with the switching range of the instrument.
- Ensure that the allowable maximum operating pressure and operating temperature of the instruments will not be exceeded.
- Remove all transport packing and be sure that no packing material is left in the instrument.
- The instrument may be installed in any position (except PSR-.32 / PSR-.40 - for horizontal installation only); however, the top half of the paddle switch must be vertically positioned in relation to the pipe axis, and the arrow on the threaded fitting must match the flow direction.
- For dirty media, it is recommended that the upper housing will be installed as close to vertical as possible, respectively with not more than 40° deviation from vertical. This will prevent dirt from being deposited in the upper housing. When this is not possible, we recommend the instrument to be cleaned more frequently (see maintenance).
- The application of PTFE tape or similar sealant to the connection threads is recommended.
- Check that the connection threads of the pipe are fully sealed.

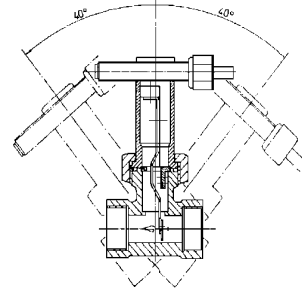

Attention! Make sure that the supply voltage to the instrument conforms to the value stated on the equipment label. For higher power loads, we recommend our contact protection relay model MSR-10.

The inlet and outlet section needs to be minimum 5 x DN in front of and after the flow meter.

8. Electrical Connection

- Ensure that the electrical supply lines are powerless.
- Connect the connection cable with your supply cable.
- The contact housing is made of glass-fibre reinforced plastic. It is insulated in accordance with VDI 0720 Class II; separate insulation measures are not necessary.

After connecting the external equipment, the instrument is ready for operation.

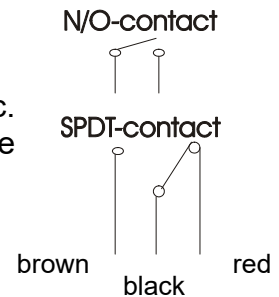

9. Limit Switches

The instrument is supplied with an adjustable contact. The standard contact, depending on the adjustments can be used either as N/O or N/C switch. The instrument is supplied ex works as a normally open contact. Optionally, the PSR/PSE can be ordered with an SPDT switch.

Contact mode

Depending on the positioning of the adjustable standard switch, the following contact modes are available.

- **Normally open**
The contact closes when the flow increases and the set point value is reached or exceeded. The switch opens again with falling flow at the minimum value based on the switch hysteresis.
- **Normally closed**
The contact opens when the flow increases and the set point value is reached or exceeded. The switch closes again with falling flow at the minimum value based on the switch hysteresis.
- **Option: Changeover (SPDT) contact**
The normally open and normally closed switch modes are simultaneously available from the same position. When retrofitting the standard design with an SPDT switch, the upper switch housing must be replaced at the same time.

Switch Point Adjustment

When adjusting the switch point, the clamp plate in the top of the upper housing must be loosened, enabling the switching unit to be repositioned. For ease of adjustment, the switching unit is marked with a white and a red arrow. The front edge of the clamp plate serves as the adjustment marker.

- **Normally open contact (standard setting, as shipped)**

The switch range is adjustable in the area of the red arrow. By sliding the switching unit in the direction of flow, the minimum switching value given in the table is achieved. By sliding the switching unit in the opposite direction, the maximum listed switch value is achieved.

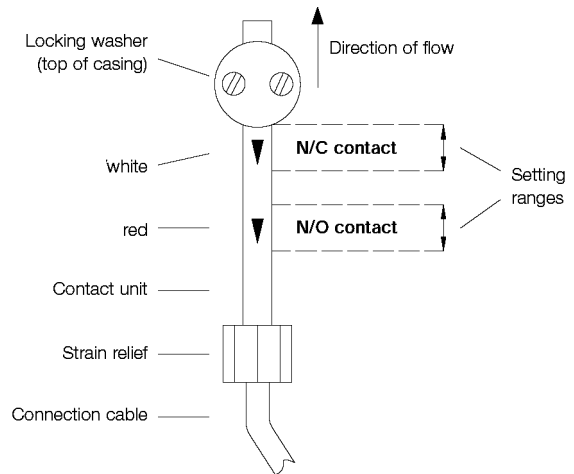

- **Normally closed contact**

The switch range is adjustable in the area of the white arrow. By sliding the switch unit in the direction of flow, the minimum switch value given in the table is achieved. By sliding the switch unit in the opposite direction, the maximum listed switch value is achieved.

- **Option: Changeover contact**

The following options for wiring apply:

Black and brown conductor = contact opens at decreasing flow.
Black and red conductor = contact closes at decreasing flow.

After successful adjustment, tighten the clamp plate by means of the screws.

Hysteresis

The Hysteresis is defined as the difference between the opening and closing flow values of a contact. For example, the model PSR 11083 with minimal switching adjustment and increasing flow is switching on at 2.3 l/min and will switch off at 1.6 l/min at decreasing flow. Contact hysteresis = 0.7 l/min.

Contact protection

The reed contact may be damaged if the switch ratings are exceeded, especially while switching inductive or capacitive loads. This can cause unsafe conditions. By using a contact protection/isolation relay (e.g.: Model MSR 10), this problem can be overcome and the lifespan and switch rating of the reed contact can be extensively increased.

10. Maintenance

In cases the measured flow medium is not polluted, the PSR/PSE will remain virtually maintenance-free. Ferritic (iron) particles in the medium may deposit on the magnet, which can lead to problems. Bigger dirt particles can lead into blocking of the balance arm. To avoid those conditions, we recommend the installation of a magnet filter (e.g.: Magnet Filter model MFR).

Depending on the amount of dirt present in the medium, we recommend the instrument to be checked and cleaned regularly.

Cleaning of the instrument

The device requires regular maintenance and cleaning. The intervals are determined by the operator according to the environmental stresses on site. It should proceed as follows:

- Shut-off the flow through the instrument.
- Ensure that there is no flow through the pipe and that the pipe is empty and not under pressure.
- Loosen the sleeve nut with a wrench (hex size 30) (only PSR-..).
- The upper switch housing and paddle arm can then be removed for cleaning.
- When cleaning the paddle arm, check that the flat spring is not damaged or bent.
- Prior to reinstallation, check that the o-ring is placed correctly in the lower housing. Dirt particles on the o-ring will lead to sealing problems.
- Insert the leaf-spring/paddle assembly into the lower housing and replace the upper housing. Note that the suspension disk of this assembly must be correctly positioned within the recesses of the upper and lower housings.
- Tighten the sleeve nut. Check that the upper half does not turn with the nut.
- Check seal tightness.



11. Technical Information

11.1. General

Tolerance of switching points:	±15 %
Medium temperature:	-20 ... +70°C (NBR seal) -10 ... +110°C (FPM seal)
Ambient temperature:	-20 ... +70°C (NBR seal) -20 ... +110°C (FPM seal)
Max. pressure:	25 bar (PSR-1132.., PSR-1140..) 100 bar (all others)
Protection:	IP 65
Preferred mounting position:	upright, horizontal PSE-1x52/PSE 1x14: only upright
Inlet/outlet:	5 x DN in each case

Electrical Details

Bistable reed contact

R	N/O / N/C contact Standard max. 2 A, max. 230 V _{AC/DC} , max. 40 W, 40 VA
U	Changeover contact Standard max. 0.5 A, max. 150 V _{AC/DC} , max. 20 W, 20 VA
C	N/O / N/C contact  2 A, 20 V _{AC} , 0.18 A, 230 V _{AC} , max. 40 W
D	Changeover contact  0.13 A, 150 V _{AC} , 0.5 A, 40 V _{AC} , max. 20 W

ATEX and IECEx

R, U N/O / N/C contact and changeover contact
max. 2 A, max. 60 V_{AC/DC}, max. 40 W, 20 VA

Ex-range:

Model PS*-**** * *** * * H or Model PS*-**** * *** * *

I M1Ex ia I Ma	Ex ia I Ma
II 1GEx ia IIC T3 Ga	Ex ia IIC T4 Ga
II 1DEx ia IIIC T135°C Da	Ex ia IIIC T135°C Da
II 2DEx ia IIIC T150°C Db	Ex ia IIIC T110°C Db



Average electrical switch contact life (MTTF):

at max. electrical load:	10 ⁵ switching operations
at half load (<10% max. load):	5*10 ⁷ switching operations
at low load (<10V/<1mA):	10 ⁸ switching operations

PSR/PSE

Material

	PSR/ PSE -11/-22	PSR/ PSE -12/-22
Case	brass 58	stainless steel 1.4301
Baffle plate	stainless steel 1.4301	stainless steel 1.4301
Leaf spring	stainless steel 1.4310	stainless steel 1.4310
Balance arm	stainless steel 1.4310	stainless steel 1.4310
Sleeve	brass 58	stainless steel 1.4301
Magnet	oxide ceramics	oxide ceramics
Seal	NBR	FPM
Contact tube	polyamide, glass-fibre-reinforced	
Cable	PVC (standard 1.5 m)	

12. Order Codes

Standard version (Example: PSR-1108 3 R08 R 1)

Standard switching ranges ¹⁾		Nominal size	Qmax. L/min. water	Model		Connection	Contact	Cable version
Rising flow rate L/min. water	Falling flow rate L/min. water			Material brass	Material stainless steel			
2.3 – 4.7	1.6 – 4.6	DN 8	30	PSR-1108 3...	PSR-1208 3...	R08= G 1/4 N08= 1/4 NPT	R = N/O contact (standard CE) C = N/O contact (cCSAus) U = Changeover contact (standard CE) D = Changeover contact (cCSAus)	PVC-cable 1 = 1.5m (standard) 2 = 2.0m ²⁾ 4 = 3.0m ²⁾ 6 = 4.0m ²⁾ 8 = 5.0m ²⁾ P = PVC cable, special length ³⁾ S = silicone cable ⁴⁾ (1.5 m length) G = yellow PUR-cable ⁴⁾ (1.5 m length) Y ⁵⁾ = silicone- or PUR-cable, special length
2.3 – 5.5	2.8 – 6.0	DN 10	40	PSR-1110 3..	PSR-1210 3...	R10= G 3/8 N10= 3/8 NPT		
2.7 – 6.4	1.9 – 6.3	DN 15	45	PSR-1115 3...	PSR-1215 3...	R15= G 1/2 N15= 1/2 NPT		
7.7 – 13.4	5.9 – 13.0	DN 20	80	PSR-1120 6..	PSR-1220 6..	R20= G3/4 N20= 3/4 NPT		
7.4 – 18.2	7.3 – 17.2	DN 25	130	PSR-1125 8...	PSR-1225 8...	R25= G 1 N25= 1 NPT		
22-38.6	21-36	DN 32	160	PSR-1132 B...	PSR-1232 B...	R32= G 1 1/4 N32= 1 1/4 NPT		
34.8-64.2	34-62.3	DN 40	300	PSR-1140 B	PSR-1240 B...	R40= G 1 1/2 N40= 1 1/2 NPT		

Special switching ranges ¹⁾		Nominal size	Qmax L/min water	Model		Connection	Contact	Cable version
Rising flow rate L/min. water	Falling flow rate L/min. water			Material brass	Material stainless steel			
4.7 – 6.5	3.4 – 6.1	DN 8	30	PSR-1108 2..	PSR-1208 2..	R08= G 1/4 N08= 1/4 NPT	R = N/O contact (standard CE) C = N/O contact (cCSAus) U = Changeover contact (standard CE) D = Changeover contact (cCSAus)	PVC-cable 1 = 1.5m (standard) 2 = 2.0m ²⁾ 4 = 3.0m ²⁾ 6 = 4.0m ²⁾ 8 = 5.0m ²⁾ P = PVC cable, special length ³⁾ S = silicone cable ⁴⁾ (1.5 m length) G = yellow PUR-cable ⁴⁾ (1.5 m length) Y ⁵⁾ = silicone- or PUR-cable, special length
5.7 – 7.7	4.5 – 7.6	DN 8	30	PSR-1108 1..	PSR-1208 1..	R10= G 3/8 N10= 3/8 NPT		
5.5 – 7.1	4.4 – 6.9	DN 10	40	PSR-1110 2...	PSR-1210 2..	R15= G 1/2 N15= 1/2 NPT		
6.6 – 8.7	5.6 – 8.5	DN 10	40	PSR-1110 1...	PSR-1210 1..	R20= G3/4 N20= 3/4 NPT		
8.3 – 10.7	7.0 – 10.3	DN 15	45	PSR-1115 2...	PSR-1215 2..			
9.2 – 12.4	8.0 – 11.8	DN 15	45	PSR-1115 1...	PSR-1215 1..			
17.8 – 24.9	14.9 – 23.3	DN 20	80	PSR-1120 5...	PSR-1220 5..			
20.4 – 30.0	16.3 – 28.3	DN 20	80	PSR-1120 4...	PSR-1220 4..			
34.6 – 48.3	30.6 – 46.7	DN 20	80	PSR-1120 1...	PSR-1220 1..			
17.7 – 26.8	12.8 – 24.7	DN 25	130	PSR-1125 7...	PSR-1225 7..			
26.0 – 36.3	21.4 – 34.1	DN 25	130	PSR-1125 5...	PSR-1225 5..	R25= G 1 N25= 1 NPT		
29.8 – 42.8	24.7 – 40.9	DN 25	130	PSR-1125 4...	PSR-1225 4..			
47.6 – 67.2	43.9 – 64.9	DN 25	130	PSR-1125 1...	PSR-1225 1..			

PSR/PSE

Standard switching ranges ¹⁾		for pipes with diameter (mm)	Qmax m ³ /h water	Model		Connection	Contact	Cable version
Rising flow rate L/min. water	Falling flow rate L/min. water			Material brass	Material stainless steel			
68 - 90	61 - 83	50	30	PSE-1149 8...	PSE-1249 8...	R15= G 1/2 N15= 1/2 NPT	R = N/O contact (standard CE)	PVC-cable 1 = 1.5m (standard) 2 = 2.0m ²⁾ 4 = 3.0m ²⁾ 6 = 4.0m ²⁾ 8 = 5.0m ²⁾ P = PVC cable, special length ³⁾ S = silicone cable ⁴⁾ (1.5 m length) G = yellow PUR-cable ⁴⁾ (1.5 m length) Y ⁵⁾ = silicone- or PUR-cable, special length
183 - 250	170 - 233	80	100					
320 - 400	300 - 383	100	150					
700 - 917	667 - 900	150	200					
50 - 62	43 - 58	50	30	PSE-1152 0...	PSE-1252 0...	R15= G 1/2 N15= 1/2 NPT	C = N/O contact (cCSAus)	
155 - 183	143 - 167	80	100					
217 - 267	200 - 250	100	150					
558 - 600	517 - 592	150	200					
92 - 113	70 - 103	100	150	PSE-1114 9...	PSE-1214 9...	R15= G 1/2 N15= 1/2 NPT	U = Changeover contact (standard CE) D = Changeover contact (cCSAus)	
200 - 283	167 - 233	150	200					
383 - 533	333 - 467	200	200					

¹⁾ Listed values are valid only for horizontal installation

²⁾ only for N/O contact "R" and "C"

³⁾ Length as described

⁴⁾ only for N/O contact "R"

⁵⁾ cable-material and -length, please specify in clear text

Order Details ATEX- and IECEx-Version (Example: PSR-2208 3 R08 R H)

Standard switch ranges ¹⁾		Nominal size	Qmax. L/min. water	Model*		Connection	Contact	Cable version	Special version
Rising flow rate L/min. water	Falling flow rate L/min. water			Material brass	Material st. steel				
2.3 - 4.7	1.6 - 4.6	DN 8	30	PSR-2108 3...	PSR-2208 3...	R08= G 1/4 N08= 1/4 NPT	R = N/O Contact (ATEX, IECEx) U = Changeover contact (ATEX, IECEx) PVC-cable 1 = 1.5m (standard) P = PVC cable, special length ³⁾	without = standard (not for PSx-22...) H = temperature of medium +110 °C (only for PSx-22...), marking acc. to certificate	
2.8 - 6.0	2.3 - 5.5	DN 10	40	PSR-2110 3..	PSR-2210 3...	R10= G 3/8 N10= 3/8 NPT			
2.5 - 6.4	1.9 - 6.3	DN 15	45	PSR-2115 3...	PSR-2215 3...	R15= G 1/2 N15= 1/2 NPT			
7.7 - 13.4	5.9 - 13.0	DN 20	80	PSR-2120 6..	PSR-2220 6..	R20= G3/4 N20= 3/4 NPT			
7.4 - 18.2	7.3 - 17.2	DN 25	130	PSR-2125 8...	PSR-2225 8...	R25= G 1 N25= 1 NPT			
22 - 38,6	21 - 36	DN 32	160	PSR-2132 B...	PSR-2232 B...	R32= G 1 1/4 N32= 1 1/4 NPT			
23.1 - 57.9	23.5 - 53.1	DN 40	300	PSR-2140 B...	PSR-2240 B...	R40= G 1 1/2 N40= 1 1/2 NPT			

PSR/PSE

Special switch ranges ¹⁾		Nominal size	Qmax. L/min. water	Model		Connection	Contact	Cable version	Special version
Rising flow rate L/min. Wasser	Falling flow rate L/min. Wasser			Material Brass	Material st. steel				
4.7 – 6.5	3.4 – 6.1	DN 8	30	PSR-2108 2..	PSR-2208 2..	R08= G 1/4 N08= 1/4 NPT	R= N/C Contact (ATEX, IECEX) U = Change-over contact (ATEX, IECEX)	PVC-cable 1 = 1.5m (standard) P = PVC cable, special length ³⁾	without = standard (not for PSx-22...) H = temperature of medium +110 °C (only for PSx-22...), marking acc. to certificate
5.7 – 7.7	4.5 – 7.6	DN 8	30	PSR-2108 1..	PSR-2208 1..				
5.5 – 7.1	4.4 – 6.9	DN 10	40	PSR-2110 2...	PSR-2210 2..	R10= G 3/8 N10= 3/8 NPT			
6.6 – 8.7	5.6 – 8.5	DN 10	40	PSR-2110 1...	PSR-2210 1..				
8.3 – 10.7	7.0 – 10.3	DN 15	45	PSR-2115 2...	PSR-2215 2..	R15= G 1/2 N15= 1/2 NPT			
9.2 – 12.4	8.0 – 11.8	DN 15	45	PSR-2115 1...	PSR-2215 1..				
17.8 – 24.9	14.9 – 23.3	DN 20	80	PSR-2120 5...	PSR-2220 5..	R20= G3/4 N20= 3/4 NPT			
20.4 – 30.0	16.3 – 28.3	DN 20	80	PSR-2120 4...	PSR-2220 4..				
34.6 – 48.3	30.6 – 46.7	DN 20	80	PSR-2120 1...	PSR-2220 1..				
17.7 – 26.8	12.8 – 24.7	DN 25	130	PSR-2125 7...	PSR-2225 7..	R25= G 1 N25= 1 NPT			
26.0 – 36.3	21.4 – 34.1	DN 25	130	PSR-2125 5...	PSR-2225 5..				
29.8 – 42.8	24.7 – 40.9	DN 25	130	PSR-2125 4...	PSR-2225 4..				
47.6 – 67.2	43.9 – 64.9	DN 25	130	PSR-2125 1...	PSR-2225 1..				

Standard switch ranges ¹⁾		For pipes with diameter [mm]	Qmax. m ³ /h water	Model		Connection	Contact	Cable version	Special version
Rising flow rate L/min. water	Falling flow rate L/min. water			Material brass	Material st. steel				
68 - 90	61 - 83	50	30	PSE-2149 8...	PSE-2249 8...	R15= G 1/2 N15= 1/2 NPT	R= N/C Contact (ATEX, IECEX) U = Changeover contact (ATEX, IECEX)	PVC-cable 1 = 1.5m (standard) P = PVC cable, special length ³⁾	without = standard (not for PSx-22...) H = temperature of medium +110 °C (only for PSx-22...), marking acc. to certificate
183 - 250	170 - 233	80	100						
320 - 400	300 - 383	100	150						
50 - 62	43 - 58	50	30	PSE-2152 0...	PSE-2252 0...	R15= G 1/2 N15= 1/2 NPT			
155 - 183	143 - 167	80	100						
217 - 267	200 - 250	100	150						
558 - 600	517 - 592	150	200	PSE-2114 9...	PSE-2214 9...	R15= G 1/2 N15= 1/2 NPT			
92 - 113	70 - 103	100	150						
200 - 283	167 - 233	150	200						
383 - 533	333 - 467	200	200						

¹⁾ Listed values are valid only for horizontal installation

²⁾ only for N/C contact "R" and "C"

³⁾ Length as described

13. Recommended Spare Parts

- 1.) Paddle (only PSR-...)
- 2.1) Spare Normally open contact
- 2.2) Spare Changeover contact
- 2.3) Conversion kit: N/O for Changeover contact (only PSR-11...)
consisting of top (sleeve) brass + 1 Changeover contact
- 2.4) Conversion kit: N/O for Changeover contact (only PSR-12...)
consisting of top (sleeve) stainless steel + 1 Changeover contact
- 3.1) FPM O-Rings
- 3.2) NBR O-Rings

14. Dimensions

Model: PSE-xx49 PSE-xx52
 PSE-xx14

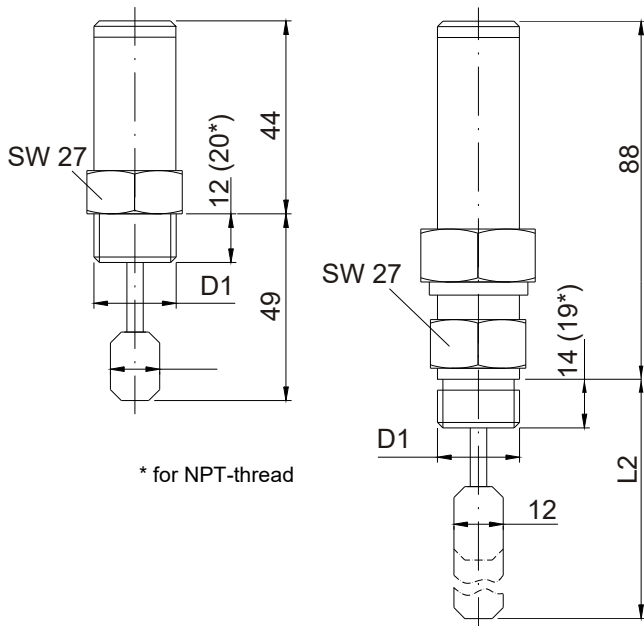

Model	D1	L ₂ [mm]
PSE-..498R	R 1/2	51
PSE-..520R	R 1/2	72
PSE-..149R	R 1/2	130
PSE-..498N	1/2 NPT	59
PSE-..520N	1/2 NPT	72
PSE-..149N	1/2 NPT	130

Model: PSR

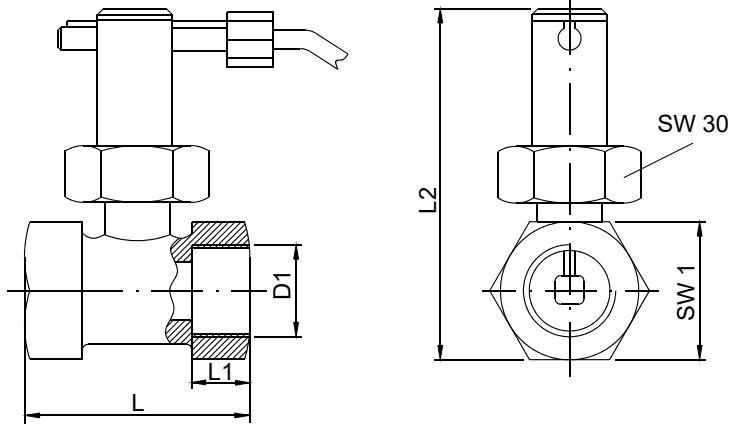

Model	D1	L [mm]	L ₁ [mm]	L ₂ [mm]	1AF
PSR-..08	G 1/4	50	10	80	27
PSR-..10	G 3/8	50	10	80	27
PSR-..15	G 1/2	50	10	80	27
PSR-..20	G 3/4	50	10	81.5	32
PSR-..25	G 1	50	10	84	39
PSR-..32	G 1 1/4	50	10	112	46
PSR-..40	G 1 1/2	50	10	119	55

15. Disposal

Note!

- Avoid environmental damage caused by media-contaminated parts
- Dispose of the device and packaging in an environmentally friendly manner
- Comply with applicable national and international disposal regulations and environmental regulations.

Batteries

Batteries containing pollutants are marked with a sign consisting of a crossed-out garbage can and the chemical symbol (Cd, Hg, Li or Pb) of the heavy metal that is decisive for the classification as containing pollutants:

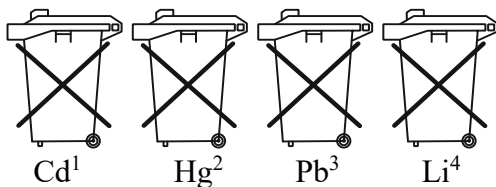

1. „Cd" stands for cadmium
2. „Hg" stands for mercury
3. „Pb" stands for lead
4. „Li" stands for lithium

Electrical and electronic equipment

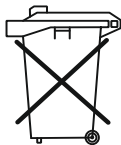

16. EU Declaration of Conformance

We, Kobold-Messring GmbH, Hofheim-Ts, Germany, declare under our sole responsibility that the product:

Paddle Flow Switch Model: PSR-x / PSE-x

to which this declaration relates is in conformity with the standards noted below:

EN 61010-1:2010

Safety requirements for electrical equipment for measurement, control and laboratory use.

EN 60529:2013

Protection through housing (IP-code)

EN IEC 63000:2018 Technical documentation for the assessment of electrical and electronic products with respect to the restriction of hazardous substances

Also, the following EC guidelines are fulfilled:

2014/35/EU	Low Voltage Directive
2011/65/EU	RoHS (category 9)
2015/863/EU	Delegated Directive (RoHS III)
2014/68/EU	PED

	Pipe	
	Table 8 Group 1 dangerous fluids	Table 9 Group 2 non-dangerous fluids
PSR-.. (1/4" - 1")	Art. 4, § 3	Art. 4, § 3
PSR-132B and PSR-140B	not deliverable	Art. 4, § 3
PSR-232B and PSR-240B	Cat. II	Art. 4, § 3

- Module D, marking CE0575
- Notified body: DNV GL
- Certificate No. PEDD000000R

PSR/PSE

Additional for PS*-2* * ** ***

2014/34/EU Equipment and Protective systems intended for use in a potentially Explosive Atmospheres

Quality Management Production

Certificate number: BVS 21 ATEX ZQS/E110

Notified body: DEKRA Testing and Certification GmbH

Identification number: 0158



H. Volz
General Manager



M. Wenzel
Proxy Holder

Hofheim, 09 Feb. 2022

17. UK Declaration of Conformity

We, KOBOLD Messring GmbH, Hofheim-Ts, Germany, declare under our sole responsibility that the product:

Paddle Flow Switch Model: PSR-x / PSE-x

to which this declaration relates is in conformity with the standards noted below:

BS EN 61010-1:2010

Safety requirements for electrical equipment for measurement, control, and laboratory use. General requirements

BS EN 60529:1992+A2:2013

Degrees of protection provided by enclosures (IP-Code)

BS EN IEC 63000:2018

Technical documentation for the assessment of electrical and electronic products with respect to the restriction of hazardous substances.

Also, the following UK guidelines are fulfilled:

S.I. 2016/1101
S.I. 2012/3032

Electrical Equipment (Safety) Regulations 2016

The Restriction of the Use of Certain Hazardous Substances in Electrical and Electronic Equipment Regulations 2012

S.I. 2016/1105

The Pressure Equipment (Safety) Regulations 2016

	Pipe	
	Table 8 Group 1 dangerous fluids	Table 9 Group 2 non-dangerous fluids
PSR-.. (1/4" - 1")	Art. 4, § 3	Art. 4, § 3
PSR-132B and PSR-140B	not deliverable	Art. 4, § 3
PSR-232B and PSR-240B	Cat. II	Art. 4, § 3

- Module D, marking CE0575
- Notified body: DNV GL
- Certificate No. PEDD000000R

H. Volz
General Manager

M. Wenzel
Proxy Holder

Hofheim, 19 September 2022

18. EU Declaration of Conformance ATEX

EU-KONFORMITÄTSERKLÄRUNG Richtlinie 2014/34/EU

EU DECLARATION OF CONFORMITY Directive 2014/34/EU

Der Hersteller

The manufacturer

KOBOLD Messring GmbH, Nordring 22-24, DE 65719 Hofheim

erklärt hiermit in alleiniger Verantwortung, dass die nachfolgende Baugruppe



hereby declares under sole responsibility, that the subassembly equipment described below

Bezeichnung

Description

Prallscheiben-Strömungswächter Typ PS*- *** ****

Kennzeichnung / Marking:

CE  I M1 Ex ia I Ma,  II 1G Ex ia IIC T4/T3 Ga oder  II 1D Ex ia IIIC IP6X T110 °C / 150 °C Da

Fertigungs-Nummer lt. Lieferpapieren und Typenschild

Serial number see shipping documents and type label

mit den Bestimmungen folgender harmonisierter Normen der Europäischen Union übereinstimmt:

conforms with the provisions of the following harmonized standards of the European Union:

- EN 60079-0:2009 Explosionsgefährdete Bereiche, - Teil 0: Betriebsmittel – Allgemeine Anforderungen
- EN 60079-11:2007 Explosionsgefährdete Bereiche – Teil 1: Geräteschutz durch Eigensicherheit „i“
- EN 50303:2000 Gruppe 1, Kategorie-M1-Geräte für den Einsatz in Atmosphären, die durch Grubengas und/oder brennbare Stäube gefährdet sind
- EN 60079-26:2007 Explosionsfähige Atmosphäre - Teil 26: Betriebsmittel mit Geräteschutzniveau (EPL) Ga
- EN 61241-0:2006 Elektrische Betriebsmittel zur Verwendung in Bereichen mit brennbarem Staub - Teil 0: Allgemeine Anforderungen
- EN 61241-11:2006 Elektrische Betriebsmittel zur Verwendung in Bereichen mit brennbarem Staub - Teil 11: Schutz durch Eigensicherheit "ID"

- EN 60079-0:2009 Explosive atmospheres - Part 0: Equipment - General requirements
- EN 60079-11:2007 Explosive atmospheres - Part 11: Equipment protection by intrinsic safety "i"
- EN 50303:2000 Group 1, Category M1 equipment intended to remain functional in atmospheres endangered by firedamp and/or coal dust
- EN 60079-26:2007 Explosive atmospheres - Part 26: Equipment with Equipment Protection Level (EPL) Ga
- EN 61241-0:2006 Electrical apparatus for use in the presence of combustible dust - Part 0: General requirements
- EN 61241-11:2006 Electrical apparatus for use in the presence of combustible dust - Part 11: Protection by intrinsic safety "ID"

Ebenfalls mit folgenden Europäischen und nationalen Normen und technischen Vorschriften übereinstimmt:

Also conforms with the following European and National Standards and technical provisions:

- Technische Regeln für Betriebssicherheit (TRBS) 2153:2009, Vermeidung von Zündgefahren infolge elektrostatischer Aufladungen

- Technical rules for the operational safety (TBRS) 2153:2009 Avoidance of ignition hazards as consequence of electrostatic charging

Die vorgenannten Baugruppen stimmen mit dem Modell überein, das die EG-Baumusterprüfbescheinigung mit der Nummer BVS 09 ATEX E 102 der benannten Stelle 0158 DEKRA EXAM GmbH, Bochum, Deutschland erhalten hat.

The equipment complies with the model, which has obtained an "EU" type certificate, number BVS 09 ATEX E 102 issued by the notified body 0158 DEKRA EXAM GmbH, Bochum, Germany.

EU-KONFORMITÄTSERKLÄRUNG
Richtlinie 2014/34/EU**EU DECLARATION OF CONFORMITY**
Directive 2014/34/EU

Eine oder mehrere der im Zertifikat aufgeführten Normen und technischen Vorschriften wurden durch neuere Ausgaben ersetzt. KOBOLD erklärt in alleiniger Verantwortung und Prüfung, dass die geänderten Anforderungen entweder nicht zutreffen oder die obengenannten Geräte den neuen Anforderungen genügen und dass folgende Normen und technischen Vorschriften erfüllt werden:

One or more of the standards and technical provisions references in the certificate have been replaced by new editions. KOBOLD declares in their sole responsibility and testing, that the changed requirements are either not applicable or the product listed above comply with them and are in compliance with the following standards and technical provisions:

- EN IEC 60079-0:2018 Explosionsgefährdete Bereiche – Teil 0: Betriebsmittel - Allgemeine Anforderungen
- EN 60079-11:2012 Explosionsgefährdete Bereiche – Teil 11: Geräteschutz durch Eigensicherheit "i"
- Technische Regeln für Gefahrstoffe (TRGS) 727:2016, Vermeidung von Zündgefahren infolge elektrostatischer Aufladungen

- *EN IEC 60079-0:2018 Explosive atmospheres – Part 0: General Requirements*
- *EN 60079-11:2012 Explosive atmospheres – Part 11: Equipment protection by intrinsic safety "i"*
- *Technical rules for hazardous substances TRGS 727:2016, Avoidance of ignition hazards as consequence of electrostatic charging*

Hofheim, den 12. Nov. 2021



H. Volz
Geschäftsführer/
General Manager



M. Wenzel
Prokurist/Proxy Holder

19. ATEX Certificate



EU-Baumusterprüfbescheinigung Nachtrag 1

Umstellung auf die Richtlinie 2014/34/EU

2 Geräte zur bestimmungsgemäßen Verwendung in explosionsgefährdeten Bereichen
Richtlinie 2014/34/EU

3 Nr. der EU-Baumusterprüfbescheinigung: **BVS 09 ATEX E 102**

4 Produkt: **Strömungswächter Typ PS*-**** * * * * ***

5 Hersteller: **KOBOLD Messring GmbH**

6 Anschrift: **Nordring 22-24, 65719 Hofheim/Ts., Deutschland**

7 Dieser Nachtrag erweitert die EG-Baumusterprüfbescheinigung Nr. BVS 09 ATEX E 102 um Produkte, die gemäß der Spezifikation in der Anlage der Bescheinigung festgelegt, entwickelt und konstruiert wurden. Die Ergänzungen sind in der Anlage zu diesem Zertifikat und in der zugehörigen Dokumentation festgelegt.

8 Die Zertifizierungsstelle der DEKRA Testing and Certification GmbH, benannte Stelle Nr. 0158 gemäß Artikel 17 der Richtlinie 2014/34/EU des Europäischen Parlaments und des Rates vom 26. Februar 2014, bescheinigt, dass das Produkt die wesentlichen Gesundheits- und Sicherheitsanforderungen für die Konzeption und den Bau von Produkten zur bestimmungsgemäßen Verwendung in explosionsgefährdeten Bereichen gemäß Anhang II der Richtlinie erfüllt. Die Ergebnisse der Prüfung sind in dem vertraulichen Prüfprotokoll BVS PP 09 2122 EU niedergelegt.

9 Die wesentlichen Gesundheits- und Sicherheitsanforderungen werden erfüllt unter Berücksichtigung von:

EN IEC 60079-0:2018 Allgemeine Anforderungen
EN 60079-11:2012 Eigensicherheit „I“

10 Falls das Zeichen „X“ hinter der Bescheinigungsnummer steht, wird in der Anlage zu dieser Bescheinigung auf besondere Bedingungen für die sichere Anwendung des Produktes hingewiesen.

11 Diese EU-Baumusterprüfbescheinigung bezieht sich nur auf den Entwurf und Bau der beschriebenen Produkte.
Für den Herstellungsprozess und die Abgabe der Produkte sind weitere Anforderungen der Richtlinie zu erfüllen, die nicht durch diese Bescheinigung abgedeckt sind.

12 Die Kennzeichnung des Produktes muss die folgenden Angaben enthalten:

	Typ PS*-**** * * * * *	oder	Typ PS*-**** * * * * *
	I M1Ex ia I Ma		Ex ia I Ma
	II 1GEx ia IIC T3 Ga		Ex ia IIC T4 Ga
	II 1DEx ia IIIC 135°C Da		Ex ia IIIC 135°C Da
	II 2DEx ia IIIC T150°C Db		Ex ia IIIC T110°C Db

DEKRA Testing and Certification GmbH
Bochum, 07.04.2021

Geschäftsführer

Seite 1 von 3 zu BVS 09 ATEX E 102 / N1 – Jobnumber 342090300
Dieses Zertifikat darf nur vollständig und unverändert weiterverbreitet werden.
DEKRA Testing and Certification GmbH, Handwerkstraße 15, 70565 Stuttgart
Zertifizierungsstelle: Dinnendahlstraße 9, 44809 Bochum
Telefon +49.234.3696-400, Fax +49.234.3696-401, DTC-Certification-body@dekra.com

13 **Anlage zur**14 **EU-Baumusterprüfbescheinigung**

**BVS 09 ATEX E 102
Nachtrag 1**

15 **Beschreibung des Produktes**15.1 **Gegenstand und Typ**

Strömungswächter Typ PS*-**** * **** *

15.2 **Beschreibung**

Mit diesem Nachtrag wird das Zertifikat auf die Richtlinie 2014/34/EU umgestellt.
(Erläuterung: Gemäß Artikel 41 der Richtlinie 2014/34/EU kann auf EG-Baumusterprüfbescheinigungen für Richtlinie 94/9/EG, die vor dem Stichtag für die Richtlinie 2014/34/EU (20.04.2016) ausgestellt wurden, so verwiesen werden, als ob diese gemäß Richtlinie 2014/34/EU ausgestellt wurden. Nachträge und neue Ausfertigungen dieser Bescheinigungen können die Originalnummern der Bescheinigungen, die vor dem 20.04.2016 vergeben wurden, beibehalten.)

Grund des Nachtrags

- Umstellung auf die Richtlinie 2014/34/EU
- Das Gerät wurde nach den aktuellen Normenfassungen geprüft.
- Reduzierte Kenngrößen für Zone 20 (EPL Da)
- Die Kennzeichnung wurde geringfügig geändert
- Neues Typenschildmaterial wird verwendet
- Die Beschreibung wurde geringfügig geändert

Beschreibung des Produkts

Der Strömungswächter, der in eigensicheren Stromkreisen als „Einfaches elektrisches Betriebsmittel“ bzw. in eigensicheren elektrischen Anlagen der Gruppe I als Zubehör verwendet wird, dient zur Überwachung von Strömungen und enthält nur Bauteile, welche die Zündschutzart „Eigensicherheit“ nicht beeinträchtigen.

Der Strömungswächter besteht aus einem Metallgehäuse, in dem ein Reedschalter vollständig vergossen untergebracht ist. Dieser Reedschalter wird durch einen Dauermagneten betätigt, der an einem Paddel befestigt ist. Dieses Paddel wird durch die Strömung des Mediums ausgelenkt. Der elektrische Anschluss erfolgt über eine fest angeschlossene Leitung.

Bei Verwendung des Strömungswächters in Bereichen, die Kategorie 1G, 1D und 2D (Zone 0, 20 und 21) -Betriebsmittel erfordern, ist dieser so zu errichten, dass eine mögliche elektrostatische Entladung der Anschlussleitung vermieden wird.



Seite 2 von 3 zu BVS 09 ATEX E 102 / N1 – Jobnumber 342090300
Dieses Zertifikat darf nur vollständig und unverändert weiterverbreitet werden.

DEKRA Testing and Certification GmbH, Handwerkstraße 15, 70565 Stuttgart
Zertifizierungsstelle: Dinnendahlstraße 9, 44809 Bochum
Telefon +49.234.3696-400, Fax +49.234.3696-401, DTC-Certification-body@dekra.com

15.3 **Kenngößen**15.3.1 **Elektrische Kenngößen nicht für Zone 20 (EPL Da)**

Maximale Eingangsspannung	U_i	AC/DC	60	V
Maximaler Eingangsstrom	I_i		2	A
Maximale Eingangsleistung	P_i		40 W / 20 VA	
Maximale innere Kapazität	C_i		vernachlässigbar	
Maximale innere Induktivität	L_i		vernachlässigbar	
Umgebungstemperaturbereich	T_a			
für Typ PS*-**** * H (T3 / T150 °C)				-20 °C bis +110 °C
für Typ PS*-**** * (T4 / T110 °C)				-20 °C bis + 70 °C

15.3.2 **Elektrische Kenngößen für den Einsatz in Zone 20 (EPL Da)**

Maximale Eingangsspannung	U_i	AC/DC	30	V
Maximaler Eingangsstrom	I_i		250	mA
Maximale Eingangsleistung	P_i			
für Typ PS*-**** * H			500	mW
für Typ PS*-**** *			650	mW
Maximale innere Kapazität	C_i		vernachlässigbar	
Maximale innere Induktivität	L_i		vernachlässigbar	
Umgebungstemperaturbereich	T_a			
für Typ PS*-**** * H (T135 °C)				-20 °C bis +110 °C
für Typ PS*-**** *				-20 °C bis +70 °C

16 **Prüfprotokoll**

BVS PP 09.2122 EU, Stand 07.04.2021

17 **Besondere Bedingungen für die Verwendung**

Keine

18 **Wesentliche Gesundheits- und Sicherheitsanforderungen**

Die wesentlichen Gesundheits- und Sicherheitsanforderungen sind durch die unter Abschnitt 9 gelisteten Normen abgedeckt.

19 **Zeichnungen und Unterlagen**

Die Zeichnungen und Unterlagen sind in dem vertraulichen Prüfprotokoll gelistet.



(1) **EG-Baumusterprüfbescheinigung**

(2) **- Richtlinie 94/9/EG -**
Geräte und Schutzsysteme zur bestimmungsgemäßen Verwendung
in explosionsgefährdeten Bereichen

(3) **BVS 09 ATEX E 102**

(4) **Gerät:** Strömungswächter Typ PS*.** *** **

(5) **Hersteller:** KOBOLD Messring GmbH

(6) **Anschrift:** 65719 Hofheim/Ts.

(7) Die Bauart dieses Gerätes sowie die verschiedenen zulässigen Ausführungen sind in der Anlage zu dieser Baumusterprüfbescheinigung festgelegt.

(8) Die Zertifizierungsstelle der DEKRA EXAM GmbH, benannte Stelle Nr. 0158 gemäß Artikel 9 der Richtlinie 94/9/EG des Europäischen Parlaments und des Rates vom 23. März 1994, bescheinigt, dass das Gerät die grundlegenden Sicherheits- und Gesundheitsanforderungen für die Konzeption und den Bau von Geräten und Schutzsystemen zur bestimmungsgemäßen Verwendung in explosionsgefährdeten Bereichen gemäß Anhang II der Richtlinie erfüllt.
 Die Ergebnisse der Prüfung sind in dem Prüfprotokoll BVS PP 09.2122 EG niedergelegt.

(9) Die grundlegenden Sicherheits- und Gesundheitsanforderungen werden erfüllt durch Übereinstimmung mit
 IEC 60079-0:2007 Allgemeine Anforderungen EN 61241-0:2006 Allgemeine Anforderungen
 EN 60079-11:2007 Eigensicherheit 'i' EN 61241-11:2006 Eigensicherheit 'iD'
 EN 50303:2000 Kategorie-M1-Geräte
 EN 60079-26:2007 Gerätegruppe II Kategorie 1G

(10) Falls das Zeichen „X“ hinter der Bescheinigungsnummer steht, wird in der Anlage zu dieser Bescheinigung auf besondere Bedingungen für die sichere Anwendung des Gerätes hingewiesen.

(11) Diese EG-Baumusterprüfbescheinigung bezieht sich nur auf die Konzeption und die Baumusterprüfung des beschriebenen Gerätes in Übereinstimmung mit der Richtlinie 94/9/EG. Für Herstellung und Inverkehrbringen des Gerätes sind weitere Anforderungen der Richtlinie zu erfüllen, die nicht durch diese Bescheinigung abgedeckt sind.

(12) Die Kennzeichnung des Gerätes muss die folgenden Angaben enthalten:

 I M1 Ex ia I Ma
 II 1G Ex ia IIC T4/T3 Ga
 II 1D Ex ia IIIC IP6x T110 °C / 150 °C Da

DEKRA EXAM GmbH

Bochum, den 04. August 2009

Zertifizierungsstelle

Fachbereich

Seite 1 von 2 zu BVS 09 ATEX E 102

Dieses Zertifikat darf nur vollständig und unverändert weiterverbreitet werden.

DEKRA EXAM GmbH Dimnendahlstraße 9 44809 Bochum Telefon 0234/3696-105 Telefax 0234/3696-110 E-mail zs-exam@dekra.com



- (13) Anlage zur
- (14) **EG-Baumusterprüfbescheinigung**
- BVS 09 ATEX E 102**

(15) 15.1 Gegenstand und Typ

Strömungswächter Typ PS*-** *** ** *

15.2 Beschreibung

Der Strömungswächter, der in eigensicheren Stromkreisen als „Einfaches elektrisches Betriebsmittel“ bzw. in eigensicheren elektrischen Anlagen der Gruppe I als Zubehör verwendet wird, dient zur Überwachung von Strömungen und enthält nur Bauteile, die die Zündschutzart „Eigensicherheit“ nicht beeinträchtigen.

Der Strömungswächter besteht aus einem Metallgehäuse, in dem ein Reedschalter vollständig vergossen untergebracht ist. Dieser Reedschalter wird durch einen Dauermagneten betätigt, der an einem Paddel befestigt ist. Dieses Paddel wird durch die Strömung des Mediums ausgelenkt.

Der elektrische Anschluss erfolgt über eine fest angeschlossene Leitung.

15.3 Kenngrößen

Schaltspannung	U _i	AC/DC 60 V
Schaltstromstärke	I _i	2 A
Schaltleistung	P _i	40W / 20VA
Umgebungstemperaturbereich bei Typ PS*-** *** ** *	T _a	-20 °C bis +110 °C
bei allen anderen Typen		-20 °C bis +70 °C
Interne Kapazität	C _i	vernachlässigbar
Interne Induktivität	L _i	vernachlässigbar

(16) Prüfprotokoll

BVS PP 09.2122 EG, Stand 04.08.2009

(17) Besondere Bedingungen für die sichere Anwendung

Entfällt

20. IECEx Certificate

		<h1>IECEX Certificate of Conformity</h1>	
INTERNATIONAL ELECTROTECHNICAL COMMISSION IEC Certification System for Explosive Atmospheres <small>for rules and details of the IECEx Scheme visit www.iecex.com</small>			
Certificate No.:	IECEX BVS 09.0044	Page 1 of 5	Certificate history: Issue 0 (2009-08-07)
Status:	Current	Issue No: 1	
Date of Issue:	2021-04-20		
Applicant:	KOBOLD Messring GmbH Nordring 22-24 65719 Hofheim/Ts. Germany		
Equipment:	Flow control device type PS[*].....		
Optional accessory:			
Type of Protection:	Intrinsic Safety "i"		
Marking:	For type PS[*]..... H Ex ia I Ma Ex ia IIC T3 Ga Ex ia IIIC T135°C Da Ex ia IIIC T150°C Db T _a : -20 °C up to +110 °C or type PS[*]..... Ex ia I Ma Ex ia IIC T4 Ga Ex ia IIIC T135°C Da Ex ia IIIC T110°C Db T _a : -20 °C up to +70 °C		
Approved for issue on behalf of the IECEx Certification Body:	Dr Franz Eickhoff Lead Auditor and officially recognised expert		
Position:			
Signature: (for printed version)	_____		
Date:	_____		
<ol style="list-style-type: none"> 1. This certificate and schedule may only be reproduced in full. 2. This certificate is not transferable and remains the property of the issuing body. 3. The Status and authenticity of this certificate may be verified by visiting www.iecex.com or use of this QR Code. 			
Certificate issued by: DEKRA Testing and Certification GmbH Certification Body Dinnendahlstrasse 9 44809 Bochum Germany		  DEKRA On the safe side.	



IECEX Certificate of Conformity

Certificate No.: **IECEX BVS 09.0044**

Page 2 of 5

Date of issue: 2021-04-20

Issue No: 1

Manufacturer: **KOBOLD Messring GmbH**
Nordring 22-24
65719 Hofheim/Ts.
Germany

Additional
manufacturing
locations:

This certificate is issued as verification that a sample(s), representative of production, was assessed and tested and found to comply with the IEC Standard list below and that the manufacturer's quality system, relating to the Ex products covered by this certificate, was assessed and found to comply with the IECEX Quality system requirements. This certificate is granted subject to the conditions as set out in IECEX Scheme Rules, IECEX 02 and Operational Documents as amended

STANDARDS :

The equipment and any acceptable variations to it specified in the schedule of this certificate and the identified documents, was found to comply with the following standards

[IEC 60079-0:2017](#) Explosive atmospheres - Part 0: Equipment - General requirements
Edition:7.0

[IEC 60079-11:2011](#) Explosive atmospheres - Part 11: Equipment protection by intrinsic safety "i"
Edition:6.0

This Certificate **does not** indicate compliance with safety and performance requirements other than those expressly included in the Standards listed above.

TEST & ASSESSMENT REPORTS:

A sample(s) of the equipment listed has successfully met the examination and test requirements as recorded in:

Test Report:

[DE/BVS/EXTR09.0038/01](#)

Quality Assessment Report:

[DE/BVS/QAR09.0001/11](#)



IECEX Certificate of Conformity

Certificate No.: **IECEX BVS 09.0044**

Page 3 of 5

Date of issue: 2021-04-20

Issue No: 1

EQUIPMENT:

Equipment and systems covered by this Certificate are as follows:

General product information

Paddle Flow Monitor type PS*-**** * **** *

Instead of the *** in the complete denomination letters and numerals will be inserted which characterize modifications.

Description

The flow monitor, which is used as "Simple apparatus" in intrinsically safe circuits resp. as "accessory" in Group I intrinsically safe systems, is used for detection of fluid flow and comprises only components which do not effect intrinsic safety.

The flow monitor consists of a metal enclosure, in which a reed contact is completely encapsulated. This reed contact will be operated by a permanent magnet which is mounted on a paddle; this paddle will be moved by the flow medium.

For use of the flow monitor in areas requiring Category 1G, 1D and 2D (Zone 0, 20 and 21) -equipment, the monitor shall be mounted in a way that possible electrostatic discharge of the cable will be avoided.

SPECIFIC CONDITIONS OF USE: NO



IECEX Certificate of Conformity

Certificate No.: **IECEX BVS 09.0044**

Page 4 of 5

Date of issue: 2021-04-20

Issue No: 1

Equipment (continued):

Parameters

Electrical parameters for use in all Zones, except Zone 20 (EPL Da)

Maximum input voltage	U_i	AC/DC	60	V
Maximum input current	I_i		2	A
Maximum input power	P_i		40 W / 20	VA
Maximum internal capacitance	C_i			negligible
Maximum internal inductance	L_i			negligible

Ambient temperature range		T_a		
for type PS*-*****H	(T3 / T150 °C)			-20 °C up to +110 °C
for type PS*-*****	(T4 / T110 °C)			-20 °C up to +70 °C

Electrical parameters for use in Zone 20 (EPL Da)

Maximum input voltage	U_i	AC/DC	30	V
Maximum input current	I_i		250	mA
Maximum input power	P_i			
for type PS*-*****H			500	mW
for type PS*-*****			650	mW

Maximum internal capacitance	C_i			negligible
Maximum internal inductance	L_i			negligible

Ambient temperature range		T_a		
for type PS*-*****H	(T135 °C)			-20 °C up to +110 °C
for type PS*-*****	(T135 °C)			-20 °C up to +70 °C



IECEX Certificate of Conformity

Certificate No.: **IECEX BVS 09.0044**

Page 5 of 5

Date of issue: 2021-04-20

Issue No: 1

DETAILS OF CERTIFICATE CHANGES (for issues 1 and above)

- The equipment has been assessed in accordance with current standard versions.
- Reduced parameters for Zone 20 (EPL Da)
- The marking was slightly changed
- New type label material is used
- The description was slightly changed