

R5099

REED INSTRUMENTS

Compact Multimeter with NCV



**Instruction
Manual**

www.REEDInstruments.com

Find Quality Products Online at:

www.GlobalTestSupply.com

sales@GlobalTestSupply.com

Table of Contents

Introduction	3
Product Quality.....	3
Safety	3-4
<i>Safety Symbols</i>	4
Features.....	4
Included.....	4
Specifications.....	4-6
Instrument Description	6
Display Description	7
Operating Instructions.....	7-11
<i>DC Voltage Measurement</i>	7
<i>AC Voltage Measurement</i>	7
<i>DC Current Measurement</i>	8
<i>AC Current Measurement</i>	8
<i>Resistance Measurement</i>	9
<i>Capacitance Measurement</i>	9
<i>Frequency Measurement</i>	9
<i>Diode Measurement</i>	10
<i>Continuity Measurement</i>	10
<i>Non-Contact AC Voltage Measurements</i>	10
<i>Data Hold</i>	11
<i>Auto Power Off</i>	11
<i>Backlight</i>	11
Battery Replacement.....	11
Applications.....	11
Product Care	12
Product Warranty	12
Product Disposal and Recycling	12
Product Support.....	13

REED

Introduction

Thank you for purchasing your REED R5099 Compact Multimeter with NCV. Please read the following instructions carefully before using your instrument. By following the steps outlined in this manual your meter will provide years of reliable service.

Product Quality

This product has been manufactured in an ISO9001 facility and has been calibrated during the manufacturing process to meet the stated product specifications. If a certificate of calibration is required please contact the nearest authorized REED distributor or authorized Service Center. Please note an additional fee for this service will apply.



Safety

- Never attempt to repair or modify your instrument. Dismantling your product, other than for the purpose of replacing batteries, may cause damage that will not be covered under the manufacturer's warranty.
- Servicing should only be provided by an authorized service center.
- Do not use the meter or test leads if they look damaged.
- Do not use the meter around explosive gas, vapor, or in damp or wet environments.
- Do not switch the function dial while taking a measurement.
- Use the meter only as specified in this manual; otherwise, the protection provided by the meter may be impaired.
- Use caution when working near voltages above 60V DC or 30V ACrms, as such voltages pose a shock hazard.
- Use extreme caution when working with high voltages.
- Always discharge filter capacitors in power supplies and disconnect the power when making resistance, continuity or diode tests.
- Always turn off the power before opening the cover to replace the batteries.
- Never operate the meter unless the battery cover is in place and fastened securely.

continued...

REED

Safety Symbols

	Refer to this manual before using the meter.
	Dangerous voltages.
	Meter is protected throughout by double insulation or reinforced insulation.

Features

- Measures AC/DC voltage and current, resistance, capacitance, frequency, diode and continuity
- Built-in non-contact voltage detector and double molded plastic housing
- 4,000-count backlit LCD display
- Low battery indicator and auto shut-off
- CAT III 600V safety rating

Included

- Test Leads
- Batteries

Specifications

AC/DC Voltage

Range:

AC: 4, 40, 400, 600V

DC: 400mV, 4, 40, 400, 600V

Accuracy:

AC: 4, 40V $\pm(1.2\% \text{ rdg.} + 5 \text{ dgt.})$

400, 600V $\pm(2\% \text{ rdg.} + 10 \text{ dgt.})$

DC: 400mV $\pm(1\% \text{ rdg.} + 8 \text{ dgt.})$

4, 40V $\pm(0.5\% \text{ rdg.} + 5 \text{ dgt.})$

400, 600V $\pm(0.8\% \text{ rdg.} + 5 \text{ dgt.})$

Resolution:

AC: 0.01, 0.01, 0.1, 1V

DC: 0.1mV, 0.001, 0.01, 0.1, 1V

continued...

REED

AC/DC Current

Range:	400 μ A, 4, 40, 400mA
Accuracy:	AC: 400 μ A, 4, 40, 400mA \pm (2% rdg. + 8 dgt.) DC: 400 μ A, 4, 40, 400mA \pm (1.8% rdg. + 5 dgt.)
Resolution:	0.1 μ A, 0.001, 0.01, 0.1mA

Resistance

Range:	400 Ω , 4, 40, 400k Ω , 4, 40M Ω
Accuracy:	400 Ω , 4, 40, 400k Ω : \pm (1% rdg. + 5 dgt.) 4M Ω : \pm (1.2% rdg. + 10 dgt.) 40M Ω : \pm (2% rdg. + 10 dgt.)
Resolution:	0.1, 1, 10, 100 Ω , 1, 10k Ω

Capacitance

Range:	50, 500nF, 5, 50, 100 μ F
Accuracy:	50nF: \pm (4% rdg.+ 30 dgt.) 500nF: \pm (3% rdg. + 15 dgt.) 5, 50, 100 μ F: \pm (4% rdg. + 10 dgt.)
Resolution:	0.01, 0.1, 1, 10, 100nF

Frequency

Range:	9.999Hz to 60kHz
Accuracy:	\pm (0.1% rdg. + 5 dgt.)
Resolution:	0.001Hz to 0.001Mz

General Specifications

Range Selection:	Autoranging
Display:	4,000 count LCD display
Display Hold:	Yes
Diode Test:	Yes
Continuity Check:	Audible signal if resistance \leq 10 Ω
Non-Contact Voltage Detector:	Yes
Auto Power Off:	Yes (after 30 minutes)

continued...

REED

Power Supply:	2 x AAA
Low Battery Indicator:	Yes
Fuse Protection:	Yes
Replaceable Test Leads:	No
Overrange Indicator:	Yes (OL)
Overvoltage Category:	CAT III 600V
Product Certifications:	CE
Operating Temperature:	32 to 104°F (0 to 40°C)
Storage Temperature:	14 to 122°F (-10 to 50°C)
Dimensions:	4.4 x 2.3 x 1.4" (112 x 58 x 35mm)
Weight:	6.3oz (180g)

Instrument Description

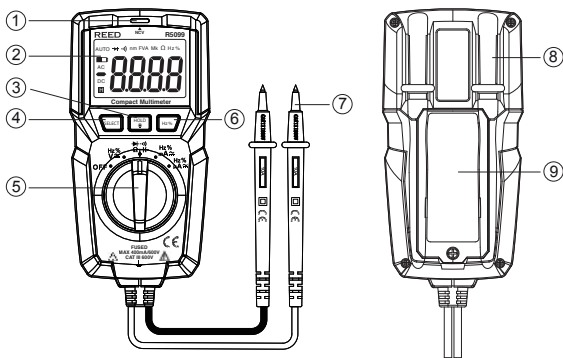

- | | |
|--------------------------|----------------------|
| 1. NCV LED Indicator | 6. Hz/% Button |
| 2. LCD Display | 7. Test Leads |
| 3. HOLD/Backlight Button | 8. Test Leads Holder |
| 4. SELECT Button | 9. Battery Cover |
| 5. Function Dial | |

REED

Display Description

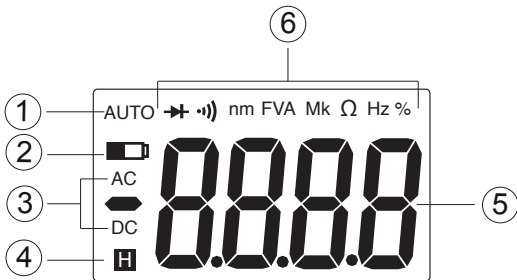

- | | |
|--------------------------|-------------------------|
| 1. Auto Range Indicator | 4. Data Hold Indicator |
| 2. Low Battery Indicator | 5. 4000 Count Display |
| 3. AC/DC Indicators | 6. Units of measurement |

Operating Instructions

DC Voltage Measurement

1. Set the function dial to the V_{\approx} position.
2. Press the **SELECT** button to indicate "DC" on the LCD display.
3. Measure the voltage by touching the test probe tips to the load in parallel.
4. Note the measured value.

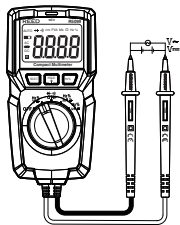

AC Voltage Measurement

1. Set the function dial to the V_{\sim} position.
2. Press the **SELECT** button to indicate "AC" on the LCD display.
3. Measure the voltage by touching the test probe tips to the load in parallel.
4. Note the measured value.

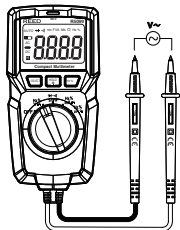

continued...

REED

DC Current Measurement

1. Set the function dial to the **mA** or **μA** position.
2. Press the **SELECT** button to indicate "DC" on the LCD display.
3. Remove power from the circuit under test, then open up the circuit at the point where you wish to measure the current.
4. Touch the black test probe tip to the negative side of the circuit. Touch the red test probe tip to the positive side of the circuit.
5. Apply power to the circuit.
6. Note the measured value.

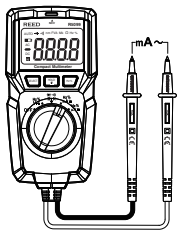

AC Current Measurement

1. Set the function dial to the **mA** or **μA** position.
2. Press the **SELECT** button to indicate "AC" on the LCD display.
3. Remove power from the circuit under test, then open up the circuit at the point where you wish to measure the current.
4. Touch the black test probe tip to the negative side of the circuit. Touch the red test probe tip to the positive side of the circuit.
5. Apply power to the circuit.
6. Note the measured value.

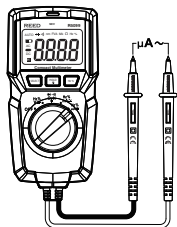

Resistance Measurement

1. Set the function dial to the Ω position.
2. Press the **SELECT** button to select resistance as indicated by Ω on the LCD display.
3. Measure the resistance by touching the test probe tips to the load in parallel.
4. Note the measured value.

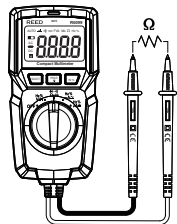

continued...

REED

Capacitance Measurement

1. Set the function dial to the C position.
2. Press the **SELECT** button to select capacitance as indicated by "nF" on the LCD display.
3. Measure the capacitance by touching the test probe tips to the load in parallel.
4. Note the measured value.

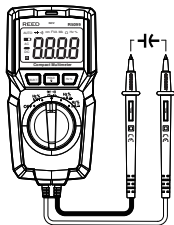

Frequency Measurement

1. Set the function dial to the Hz position.
2. Press the **HZ** button to select frequency as indicated by "Hz" on the LCD display.
3. Measure the frequency by touching the test probe tips to the load.
4. Note the measured value.

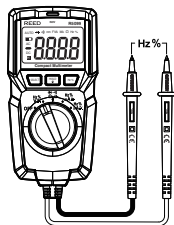

Diode Measurement

1. Set the function dial to the D position.
2. Press the **SELECT** button to select diode as indicated by D on the LCD display.
3. Measure the frequency by touching the test probe tips to the load in parallel.
4. Note the measured value.

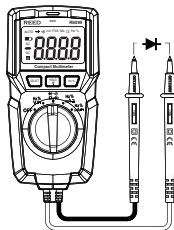



Forward voltage will indicate 0.5V to 0.8V. Reverse voltage will indicate "OL". Shorted devices will indicate near 0mV and an open device will indicate "OL" in both polarities.

continued...

REED

Continuity Measurement

1. Set the function dial to the  position.
2. Press the **SELECT** button to select continuity as indicated by  on the LCD display.
3. Measure the continuity by touching the test probe tips to the load in parallel.
4. Note the measured value.

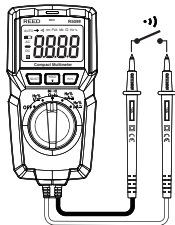

If the measured resistance is $>1000\Omega$, circuit is open. If the measured resistance $\leq 10\Omega$, the audible buzzer will sound.

Non-Contact AC Voltage Measurements

WARNING: Risk of electrocution. Before use, always test the Voltage Detector on a known live circuit to verify proper operation.

1. Set the function dial to any position.
2. Place the tip of the meter to the hot conductor or on the hot side of the electrical outlet.
3. If AC voltage is present, the detector light will illuminate.

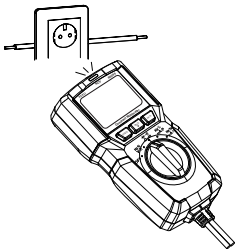

NOTE: The conductors in electrical cord sets are often twisted. For best results, rub the meter tip along the length of the cord to assure placing the tip in close proximity to the live conductor.

NOTE 2: The detector is designed with high sensitivity. Static electricity or other sources of energy may randomly trip the sensor. This is normal operation.

continued...

REED

Data Hold

1. While taking a measurement, press the **HOLD** button to freeze the current reading on the LCD display.
2. While in this mode an "H" symbol will appear.
3. Press the **HOLD** button again to resume normal operation.

Auto Power Off

To preserve battery life, the meter is programmed to turn itself off after 30 minutes of inactivity. Press any button to delay the auto power off function and resume normal operation.

Backlight

To turn the backlight on or off, press and hold the **BACKLIGHT** button for 2 seconds.

Battery Replacement

When the low battery icon  appears on the LCD, the batteries must be replaced.

1. Use a small Phillips head screwdriver to remove the battery cover located on the back of the meter.
2. Replace the 2 x "AAA" batteries.
3. Secure the battery cover back and tighten the screw.

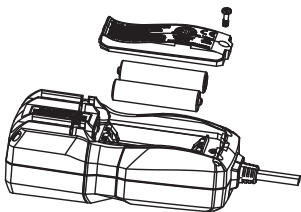

Applications

- Testing batteries
- Testing household wiring
- Testing electric motors
- Testing power supplies

REED

Product Care

To keep your instrument in good working order we recommend the following:

- Store your product in a clean, dry place.
- Change the battery as needed.
- If your instrument isn't being used for a period of one month or longer please remove the battery.
- Clean your product and accessories with biodegradable cleaner. Do not spray the cleaner directly on the instrument. Use on external parts only.

Product Warranty

REED Instruments guarantees this instrument to be free of defects in material or workmanship for a period of one (1) year from date of shipment. During the warranty period, REED Instruments will repair or replace, at no charge, products or parts of a product that proves to be defective because of improper material or workmanship, under normal use and maintenance. REED Instruments total liability is limited to repair or replacement of the product. REED Instruments shall not be liable for damages to goods, property, or persons due to improper use or through attempts to utilize the instrument under conditions which exceed the designed capabilities. In order to begin the warranty service process, please contact us by email at 1-877-849-2127 or info@reedinstruments.com to discuss the claim and determine the appropriate steps to process the warranty.

Product Disposal and Recycling



Please follow local laws and regulations when disposing or recycling your instrument. Your product contains electronic components and must be disposed of separately from standard waste products.

REED

Product Support

If you have any questions on your product, please contact your authorized REED distributor or REED Instruments Customer Service by phone at 1-877-849-2127 or by email at info@reedinstruments.com.

Please visit www.REEDINSTRUMENTS.com for the most up-to-date manuals, datasheets, product guides and software.

*Product specifications subject to change without notice.
All rights reserved. Any unauthorized copying or reproduction of this manual is strictly prohibited without prior written permission from REED Instruments.*

REED

REED

INSTRUMENTS

TEST & MEASURE WITH CONFIDENCE



CHECK OUT OUR LATEST PRODUCTS!

www.REEDINSTRUMENTS.com

Find Quality Products Online at:

www.GlobalTestSupply.com

sales@GlobalTestSupply.com