



**RTD-10 / RTD-10W**  
**RTD Thermometer**  
**RTD Thermometer**  
**Wireless**

**Users Manual**

- Mode d'emploi
- Bedienungshandbuch
- Manual d'Uso
- Manual de uso



**RTD-10**  
**RTD-10W**  
**RTD Thermometer**  
**RTD Thermometer**  
**Wireless**

English

**Users Manual**

June 2010, Rev.1  
©2010 Amprobe Test Tools.  
All rights reserved. Printed in Taiwan

**RTD-10 /RTD-10W**

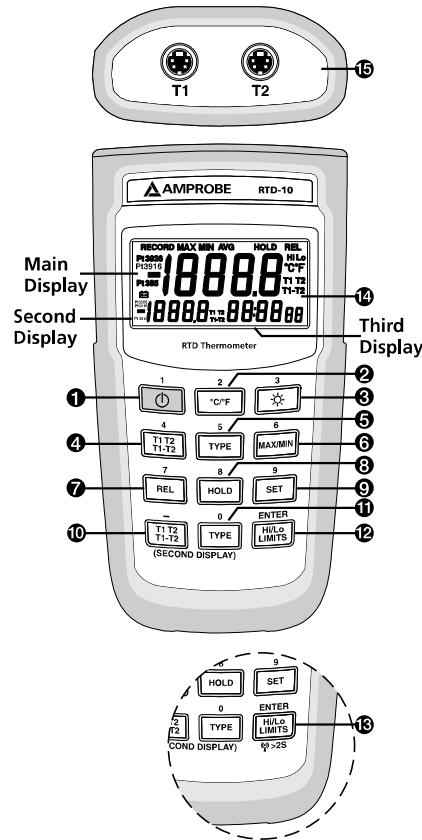



---

**CONTENTS**

**SYMBOLS** ..... 2

**UNPACKING AND INSPECTION** ..... 3

**INTRODUCTION** ..... 4

    Features ..... 4

**OPERATION INSTRUCTIONS** ..... 4

    “” Button..... 4

    “°C/°F” Selecting the Temperature Scale..... 5

    “” Display Back-Light..... 5

    “T1 T2/T1-T2” Main display Input Selection ..... 5

    “TYPE”(Pt385/Pt3926/Pt3916)  
    Main display Input RTD Probe Select..... 5

    “MAX/MIN” With Time Record Mode ..... 5

    “REL” Relative Mode ..... 6

    “HOLD” Mode..... 6

    “SET” Mode..... 7

    T1/T2 T1-T2 second display Input Selection..... 7

    “TYPE”(Pt385/Pt3926/Pt3916)  
    Second display Input RTD Probe select..... 8

    Wireless Mode (RTD-10W Only) ..... 8





**RTD PROBE CONNECTION** ..... 9

**TEMPERATURE VSRESISTANCE TABLE (ITS90)** ..... 10

**SPECIFICATION**..... 10

**MAINTENANCE** ..... 11

## SYMBOLS

	Caution! Refer to the explanation in this Manual
	Conforms to relevant Australian standards
	Complies with European Directives
	Tested Comply With FCC Standards
	Do not dispose of this clamp meter as unsorted municipal waste.

### **⚠ WARNING and PRECAUTIONS**

- *To avoid electrical shock, do not use this instrument when working voltages at the measurement surface over 24V AC or DC.*
- *To avoid damage or burns, do not make temperature measurement in microwave ovens.*

### **Federal Communications Commission**

This device RTD-10W complies with Part 15 of the FCC Rules. Operation is subject to the following two conditions: (1) this device may not cause harmful interference, and (2) this device must accept any interference received, including interference that may cause undesired operation.

### **Note**

This equipment RTD-10W has been tested and found to comply with the limits for a Class B digital device, pursuant to Part 15 of the FCC Rules. These limits are designed to provide reasonable protection. This equipment generates, uses and can radiated radio frequency energy and, if not installed and used in accordance with the instructions, may cause harmful interference to radio communications. However, there is no guarantee that interference will not occur in a particular installation if this equipment does cause

harmful interference to radio or television reception, which can be determined by turning the equipment off and on, the user is encouraged to try to correct the interference by one or more of the following measures:

- Reorient or relocate the receiving antenna.
- Increase the separation between the equipment and receiver.
- Connect the equipment into an outlet on a circuit different from that to which the receiver is connected.
- Consult the dealer or an experienced radio/TV technician for help.

Shielded interface cables must be used in order to comply with emission limits.

Changes or modifications not expressly approved by the party responsible for compliance could void the user's authority to operate the equipment

#### **Wireless Note**

Wireless receiver must keep a distance at least 40cm from the meter and meter to meter distance must be at least 30cm.

#### **UNPACKING AND INSPECTION**

---

Your shipping carton should include:

- 1 Thermometer
- 2 RTD Connectors
- 4 AAA Batteries
- 1 USB Wireless Antenna (RTD-10W)
- 1 Software CD ROM (RTD-10W)
- 1 Manual
- 1 Plain white box

If any of the items are damaged or missing, return the complete package to the place of purchase for an exchange.

### **INTRODUCTION**

---

This instrument is a 4½ digit, compact-sized portable digital thermometer designed to use external 100Ω Platinum RTD as temperature sensor. Temperature indication follows Reference Temperature/Resistance Tables (Pt385 for European Curve, Alpha=.00385. Pt3926 for American Curve, Alpha=.003926. Pt3916 for Japan Curve, Alpha=.003916.)

#### **Features**

- Wireless two ways transmission. (RTD-10W only)
- Dual input function.
- Pt3916/Pt3926/Pt385 RTD standard.
- MAX/MIN with elapsed time, AVG, REL, HOLD function.
- Warning beeper with Hi/Lo setting.
- Time setting, REL setting.
- According to temperature standard ITS-90.
- °C/°F user-selective.
- Resolution 0.1°C to 0.2°F.

### **OPERATING INSTRUCTIONS**

---

#### **“” Power Button**

The “” key turns the thermometer on or off. In the SET mode cannot be powered off. Exit SET mode to power off.



#### **APO function mode**

Press "⏻" power key for more than 6 seconds to disable the auto-power function. The display will show "APO OFF".

#### **" °C/°F " Selecting the Temperature Scale**

Readings are displayed in either degrees Celsius(°C) or degrees Fahrenheit(°F). When the thermometer is turned on, it is set to the temperature scale that was in use when the thermometer was last turned off. To change the temperature scale, press the "°C/°F" key

#### **"☀" " Display Back-Light**

Press the "☀" key to turn on or turn off the Back-Light.

#### **"T1 T2/T1-T2" Main display Input Selection**

The input selection indicates which input is selected for main display; T1 probe, T2 probe or the difference between the two probes (T1-T2). When the thermometer is turned on, it is set to T1, when main display input selected T1, then T1 input can select alternate of probe by pressing Pt385/Pt3926/Pt3916 key switch.

#### **"TYPE"(Pt385/Pt3926/Pt3916) Main display Input RTD Probe Select**

The "TYPE" key switches the T1 input to select the Pt385, Pt3926 or Pt3916 RTD probe as input, when main display input selected T1. When the thermometer is turned on, it is set to the probe selected that was in use when the thermometer was last turned off.

#### **"MAX/MIN" With Time Record Mode (only Main display)**

Press "MAX/MIN" key to enter the MAX MIN Recording mode, (displays the Maximum reading with time, Minimum reading with time and Average reading stored in record mode). In the this mode the automatic power-

off feature is disabled and "⏸" key, "°C/°F" key, "REL" key, "SET" key, "Hi/Lo LIMITS" key and main display "T1 T2 T1- T2" key, "TYPE" key are disabled. The beeper emits a tone when a new minimum or maximum value is recorded.

Press "MAX/MIN" key to cycle through the MAX, MIN and AVG readings. If an overload is recorded, the averaging function is stopped. In this mode, press the "HOLD" key to stop the recording of readings, all values are held, press again to restart recording.

To prevent accidental loss of MAX, MIN and AVG data, this mode can only be cancelled by pressing and holding the "MAX/MIN" key for 2 seconds. All recorded readings are erased.

#### **"REL" Relative Mode (only Main display)**

Press the "REL" key to enter the relative mode, zero the display, and store the displayed Reading as a reference value. REL is shown on the display. Press "REL" key again to exit the relative mode. The relative reference value can also be entered by the user. (See "SET mode" later in this manual). When the desired relative value has been entered, press "REL" key to enter the relative mode and then press "SET" key use the entered relative value as a reference value. Press "REL" key again to exit the relative mode. In the relative mode, the value (can not  $\geq \pm 1999.9$  counts) shown on the LCD is always the difference between the stored reference and the present reading.

#### **"HOLD" Mode (only Main display)**

Press the "HOLD" key to enter the Data Hold mode, the "HOLD" annunciator is displayed. When HOLD mode is selected, the thermometer held the present readings and stops all further measurements. Press the "HOLD" key again to cancel HOLD mode causing thermometer to resume taking measurements. In the MAX/MIN recording mode, press "HOLD" key to stop the recording. Press

“HOLD” key again to resume recording. (Previously recorded read are not erased).

#### **“SET” Mode (Relative value set, Time set and Hi/Lo Limits value set)**

1. Press the “SET” key to enter relative values SET mode (Press “ENTER” key to skip setting relative value). “= = =.=” is displayed on the main display. The relative value is entered via overlay numbers, press overlay “ENTER” key to store the relative value, and advance to elapsed time set mode.
2. Elapsed time set mode, (Press “ENTER” key to skip Elapsed time set mode) “=.= = : =.=” is displayed in second and third display. Time (hours, minutes, seconds) value is entered via overlay numbers, press overlay “ENTER” key to store time value. Elapsed time starts from set time value.
3. Hi Limit value set mode, (Press “ENTER” key to skip Hi Limit value set mode), “= = =.=” is displayed in main display, Hi Limit value is entered via overlay numbers, then press “ENTER” key to store the Hi Limit value. “= = =.=” is displayed in main display, Lo Limit value is entered via overlay numbers, then press overlay “ENTER” key to store the Lo Limit value and exit SET mode.
4. When the thermometer is turned on it uses the relative value and Hi/Lo Limits values that were entered when thermometer was last in use.

#### **T1 T2 / T1-T2 second display Input Selection**

The input selection indicates which input is selected for second display; T1 probe, T2 probe or the difference between the two probes (T1-T2), when the thermometer is turned on, it is set to T2 input can select alternate of probe by second display Pt385/Pt3926/Pt3916 key switch.



**“TYPE”(Pt385/Pt3926/Pt3916) Second display Input  
RTD Probe select**

The Pt385/Pt3926 key switches the T2 input to select the Pt385, Pt3926 or Pt3916 RTD probe as input, when second display input selected T2. When the thermometer is turned on, it is set to the RTD selected that was in use when the thermometer was last turned off.

**“Hi/Lo LIMITS” Mode (only Main display)**

Press “Hi/Lo LIMITS” key to enter the Hi/Lo Limits comparative mode. When the input temperature value exceeds the Hi or Lo Limits value, the beeper emits a continuous or pulsed tone. Press “Hi/Lo LIMITS” key again to exit the Hi/Lo Limits mode.

**Wireless Mode (RTD-10W Only)**

Press the “” key for more than two seconds to start wireless function. Press the “” key again for another two seconds to stop wireless function. The wireless mode will shut down if there is no wireless signal for two minutes.

To SET CH/ID to 00,00, press the “Hi/Lo LIMITS” key and “” power key for more than 6 seconds with the meter powered down. The meter will set channel and ID to 00,00 status. The second display will show 00, which means that the channel and ID has been set to 00.

**To check the channel and ID of the meter**

When the meter is off, press “°C/°F” key and “” for 5 seconds, LCD’s main display will show channel number, the second display will show ID number.

## RTD PROBE CONNECTION

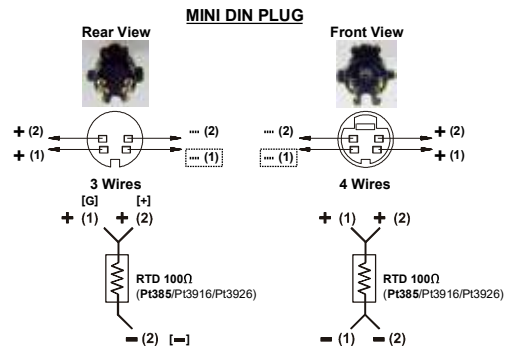

Temperature Vsresistance Table (ITS90)

°C	Pt385	Pt3926	Pt3916
-200°C	18.521Ω	16.996Ω	17.057Ω
-100°C	60.256Ω	59.479Ω	59.565Ω
0°C	100.000Ω	100.000Ω	100.000Ω
100°C	138.505Ω	139.272Ω	139.171Ω
200°C	175.856Ω	177.362Ω	177.155Ω
300°C	212.052Ω	214.275Ω	213.957Ω
400°C	247.092Ω	250.018Ω	249.584Ω
500°C	280.977Ω	284.591Ω	284.036Ω
600°C	313.708Ω	317.994Ω	317.313Ω
700°C	345.280Ω	-	-
800°C	375.700Ω	-	-

## SPECIFICATION

### Electrical

<b>Temperature Scale</b>	Celsius or Fahrenheit user-selectable
<b>Measurement Range</b>	Pt385 (100Ω) -200°C to 800°C (-328°F to 1472°F) Pt3916/Pt3926 (100Ω) -200°C to 630°C (-328°F to 1166°F)
<b>Resolution</b>	0.1°C or 0.2°F
<b>Accuracy</b>	Accuracy is specified for operating temperatures over the range of 18°C to 28°C (64°F to 82°F), for 1 year, not including RTD probe error. ±(0.05%rdg+0.2°C) on °C scale ±(0.05%rdg+0.4°F) on °F scale
<b>Temperature Coefficient</b>	0.1 times the applicable accuracy specification per °C from 0°C to 18°C and 28°C to 50°C (32°F to 64°F and 82°F to 122°F).
<b>Input Protection</b>	24V dc or 24V ac rms maximum input Voltage on any combination of input pins.
<b>Input Connector</b>	Accepts for 3 wires or 4 wires Mini-Din plug and the meter is designed for standard. The other probes 2.3 wires will cause measuring tolerance due to cable resistance.

**Maximum Differential Common Mode Voltage (Maximum Voltage between T1 and T2 during measurement): 1 Volt**

### Environmental

<b>Ambient Operating Ranges</b>	0°C to 50°C (32°F to 122°F) <80% R.H.
<b>Storage Temperature</b>	-20°C to 60°C (-4°F to 140°F) <70% R.H.

### General

<b>Display</b>	4½ digit liquid crystal display (LCD) with maximum reading of 19999.
<b>Overload</b>	"----." or "OL" is display
<b>Reading Rate</b>	1 time per second.
<b>Auto power off</b>	30 minutes, press power key to resume operation
<b>Battery</b>	1.5V x 4pcs AAA size
<b>Battery Life</b>	200 hours typical with carbon zinc battery
<b>Dimensions</b>	160mm(H) x 83mm(W) x 38mm(D); 6.3 in (H) x 3.3 in (W) x 1.5 in (D).
<b>Weight</b>	Approx. 260g (0.6lb) including batteries

### ☎️ **Wireless Features**

Frequency range 910-920MHz (RTD-10W Only)  
Low current consumption less than 1 mA.  
The transmitting distance can reach 25 M without magnetic interference.

### CE - EMC: Conforms to EN61326-1.

This product complies with requirements of the following European Community Directives: 89/ 336/ EEC (Electromagnetic Compatibility) and 73/ 23/ EEC (Low Voltage) as amended by 93/ 68/ EEC (CE Marking).

However, electrical noise or intense electromagnetic fields in the vicinity of the equipment may disturb the measurement circuit. Measuring instruments will also respond to unwanted signals that may be present within the measurement circuit. Users should exercise care and take appropriate precautions to avoid misleading results when making measurements in the presence of electronic interference.

## MAINTENANCE AND REPAIR

---

### Warning

To avoid possible electrical shock, disconnect the thermocouple connectors from the thermometer before removing the cover.

### Installing and Replacing Battery

- A. Screw
- B. Battery Cover
- C. Battery

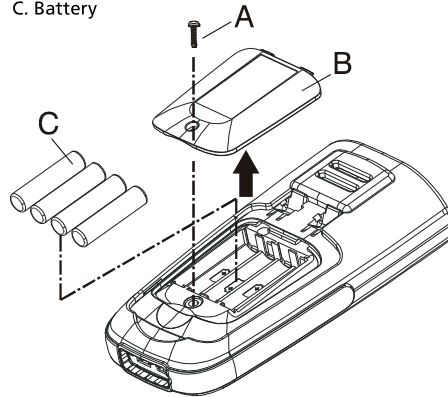



1. Power is supplied by 4pcs 1.5V (SIZE AAA) UM-4 R03.
2. The “” appears on the LCD display when replacement is needed. To replace battery remove screw from back of meter and lift off the battery cover.
3. Remove the batteries from the battery compartment and replace them with new ones.
4. When not use for long time, remove the battery.
5. Do not store the unit in place with temperature and humidity beyond the recommended storage temperature.

#### **Cleaning**

Periodically wipe the case with a damp cloth and detergent, do not use abrasives or solvents.