

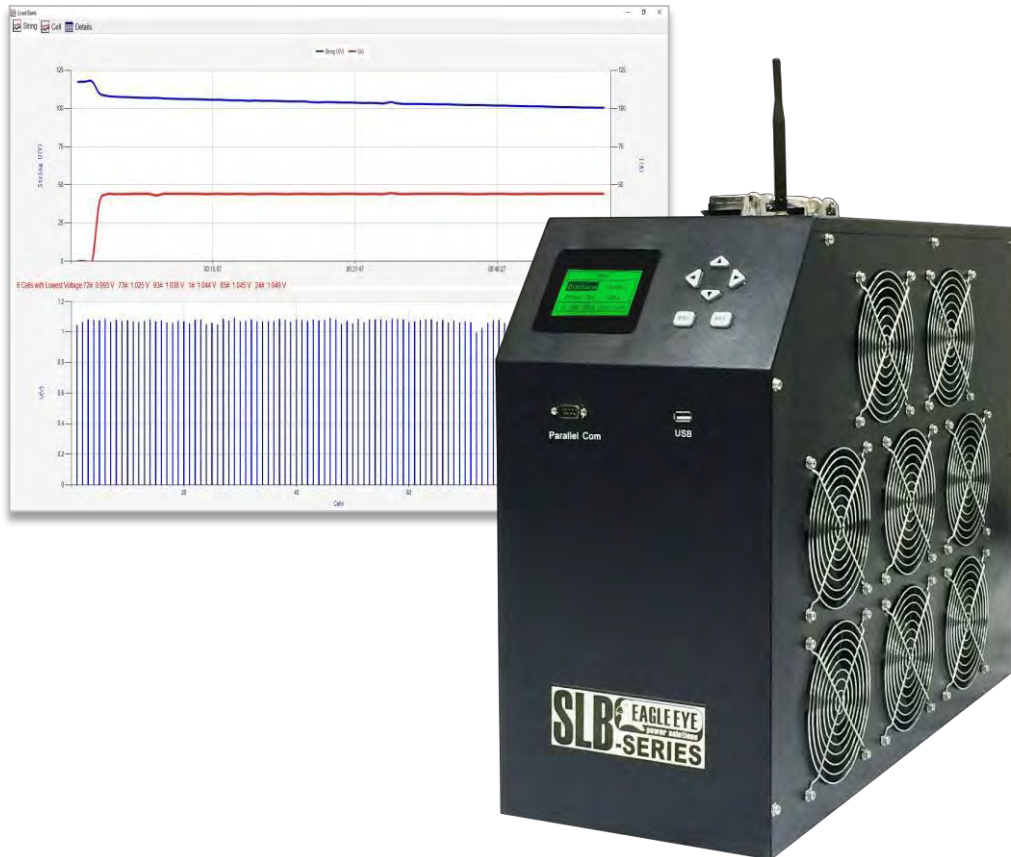

SLB-SERIES SMART DC LOAD BANKS User Manual V1.1





Contents

Introduction	4
Safety Information.....	4
Product Overview	5
Features	5
Parts List.....	6
Front View	7
Rear View	8
Display and Keypad.....	9
Menu Abbreviations	9
Testing Preparation	10
Standard Cables	10
SLB Connection Workflow	12
DAC Connection	13
DAC Test Leads Explained	14
DAC Connection to 2V/1.2V Cells:.....	15
DAC Workflow Connection to 6V/12V Cells:	16
Multiple DAC Notice.....	17
Software	18
Installation	18
Preparing for Testing	19
Live Monitoring	22
Exporting Data	25
Discharge Testing.....	27
Starting a Discharge Test.....	29
During the Discharge Test	30
Continued Discharge	32
Parallel Load Test.....	32



Other Tests	33
Assistant Discharge Test	33
External Test	34
Charge Monitor	34
SLB Disconnection Workflow	35
Data Management.....	35
System Management.....	36
Time and Date Setting	37
Parameter Management	37
Function Settings	40
Service & Maintenance.....	40
Troubleshooting	41
Error Codes	42
APPENDIX A: General Specifications	44
APPENDIX B: Discharge Specifications.....	45



Introduction

This manual provides guided information on how to use Eagle Eye's Smart Load Banks (SLB) Series safely and effectively. It is universal to all Eagle Eye SLB-Series models. Please read the manual carefully to obtain maximum performance of the load bank and its accessories. It will cover setup, installation, operation, and troubleshooting of the load bank and its accompanying Data View Management Software.

Safety Information

WARNING:

- The electrical voltage and current used in battery testing is potentially lethal, please be cautious and follow all safety standards.
- Ensure that AC power supply is isolated and any battery being tested is disconnected before attempting to clean or perform maintenance on the unit.
- If equipped with circuit breaker(s), do not connect or disconnect any of the cables unless the breakers are in the off position. This could cause damage to the unit or battery system or create an arc flash.
- Do not touch conducting parts of the load cables or the voltage cables when they are connected to the load OR battery banks.
- Always place the load bank as far away from the batteries as possible.
- Excessive discharge on a battery can cause severe damage to it and in rare circumstances explode or overheat (thermal runaway). Always follow rated discharge specifications. This are best acquired from the battery manufacturer.
- Charging and discharging batteries causes hydrogen gas release. Always have adequate ventilation in place. Installing HGD-2000 hydrogen gas detectors also increases employee and building safety warning alarms.
- If you see any sparks from your batteries, testing cables, or the load bank body, shutdown the unit immediately and disconnect all cables for further inspection.

General Equipment Precautions:

- To avoid frequency interference, do not run two SLB-Series units in the same location within 100 meters if it is not in parallel connection.
- Before testing, be sure that the nominal voltage range on the load bank matches that of the battery string being tested.
- Use only the insulated load cables that come with the load bank.
- Be sure that the mains voltage and frequency fit the local AC power supply. Do not apply the unit to voltages that are above the rated mains of the unit.



- After discharging batteries, keep the unit running for at least 10 minutes to allow proper cooling of internal components.

CAUTION: Do not leave any SLB-Series load bank unattended during operation. Remain in the vicinity of the unit during any type of discharge test.

Product Overview

The Eagle Eye SLB-Series Load Banks can be used for battery discharge testing, capacity testing, battery string maintenance, project cleanup and acceptance, as well as DC power load testing. It is used to test the performance capacity of cells to verify whether or not they need to be replaced.

The wireless Data Acquisition Communication (DAC) modules enables continuous monitoring and display of the discharge process. The measurement data is displayed directly on the unit and also has the option to be displayed in the software.

With the optional external current clamp, the Eagle Eye SLB-Series can be used to assist DC loads and monitor the total voltage, cell voltages, and current from both load sources. The external current clamp also allows the load bank to be setup as a charge monitor.

Features

- SMART Load Banks with system and per cell monitoring (with DAC)
- Data View Management Software for data analyzing and reporting with Microsoft Excel
- Rugged, compact and portable unit with included carrying case (for applicable models)
- Four user-defined settings for automatic shut-down of discharge load: discharge time, discharged capacity, low cell voltage (with DAC), and total string low voltage
- Continued discharge available when weak batteries low cell voltages reach cut-off value
- Parallel connection of two units for increased discharge testing
- AC & DC power supply modes available
- Integrated functions for displaying, controlling and discharging
- Included USB drive for convenient data transfer from load bank to PC
- Wireless communication for convenient discharge monitoring on PC
- **Optional** Real-time display of voltage for each cell with DAC package
- **Optional** External current clamp for assistive discharge or charge monitoring

Parts List

After receiving your Eagle Eye SLB-Series, please ensure that no damage occurred during shipping.

<p>SLB-Series Unit</p>		<p>Grounding Line</p>	
<p>Data COM Terminal For communication between COM Terminal, Load Bank, and DAC (if applicable)</p>		<p>Wireless Communication Antenna For communication with COM terminal and DAC(if applicable)</p>	
<p>RS-232 Adapter Serial adapter for COM Terminal</p>		<p>External Current Clamp (optional)</p>	
<p>Positive Load Cable</p>		<p>USB Drive Contains software, user manual and firmware</p>	
<p>Negative Load Cable</p>		<p>DAC For monitoring cell voltage (2V, 6V, 12V standard)</p>	
<p>String Voltage Leads For measuring total string voltage</p>		<p>7-Lead Voltage Cable For 1.2, 2V cells</p>	

AC Power Cord		3-Lead Voltage Cable For 4, 6, 12V cells	
---------------	---	---	---

Front View

The front of the SLB load bank houses all the controls for operating the unit. Use the directional buttons to navigate the menu. Continue on for details on using the keypad.

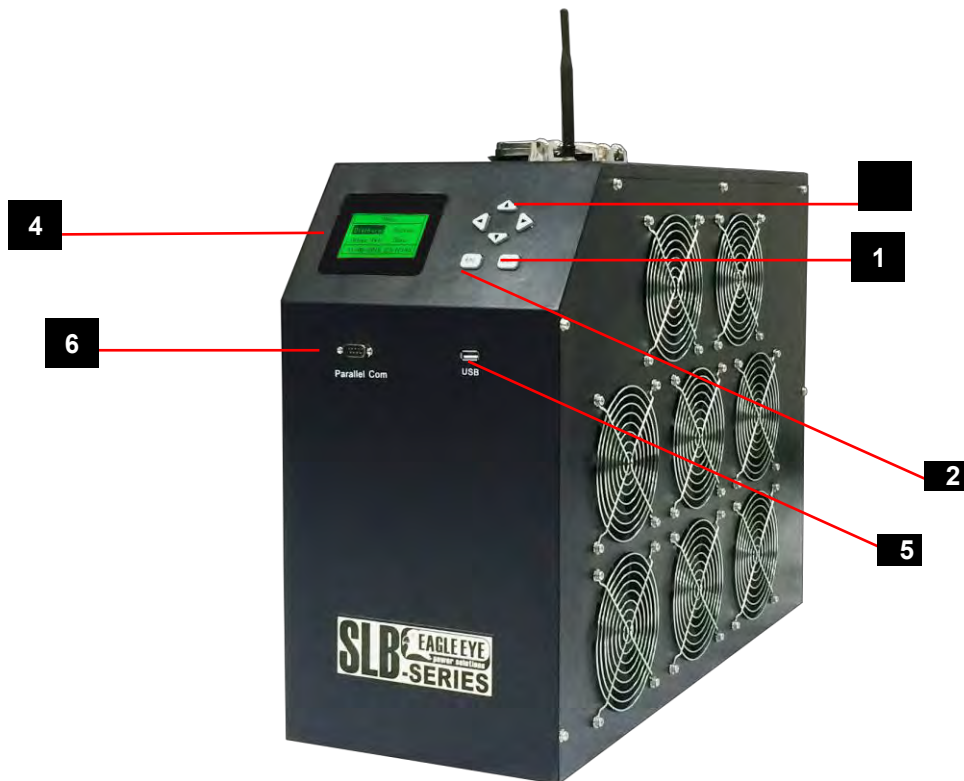

SLB-Series (Medium Size)

1. Enter “**ENT**” button
2. Escape “**ESC**” button
3. Directional buttons
4. LCD display
5. USB port (for update and data backup)
6. Serial port (for parallel load connection)

Rear View

All cables connect to the back side, for details on connecting cables continue reading.

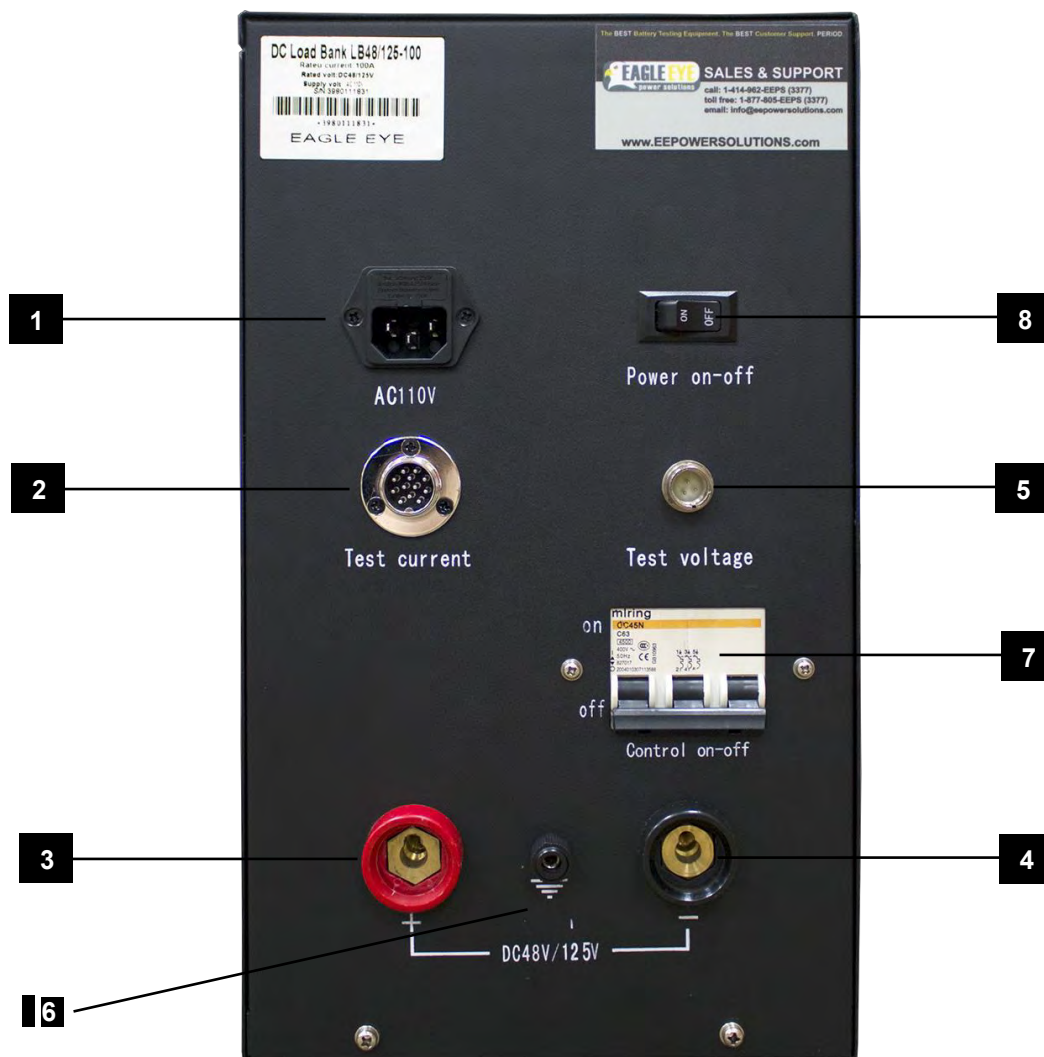

SLB-Series Rear View (Medium Size)

1. AC power input
2. Connection for external current clamp (optional)
3. Connection for positive load cable*
4. Connection for negative load cable*

IMPORTANT: Some models will have (2) of each load cable connection as well as multiple breaker switches. When there are multiple connections and breakers, all connections must be

5. Connection for string voltage test leads
6. Connection for ground
7. Breaker switch* (required to be on for discharge testing)
8. Main unit power switch

Display and Keypad

All tests and functions are controlled from the display and keypad; the software is not used for control of the load bank. Its function is for live viewing and data analysis. The 6-button keypad enables quick navigation between the LCD display and menu.

Keys	Function
▼ ▲	Move up and down to highlight options
◀ ▶	- Change numbers - Move left, right to highlight options
ENT	Confirm selection or number input
ESC	Return to the previous menu

Menu	
Discharge	System
Other Test	Data
07/21/2016	02:57:48

Default Menu Screen

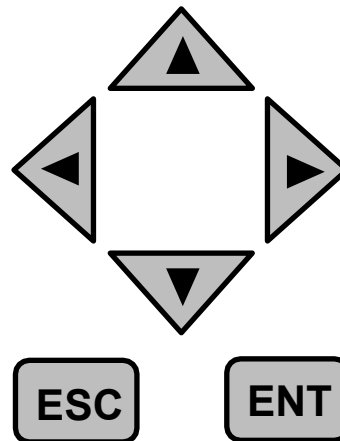

Keypad

Menu Abbreviations

While using the SLB-Series menu screen a variety of abbreviations will be displayed. Below is a list of displayed abbreviations you will encounter throughout the menus.

Abbreviation	Full Name	Abbreviation	Full Name
avg	average	I	current
DIS	discharge	Paral	parallel
C	capacity	param	parameter
calib	calibration	strg/stg	string

Case/DAC	acquisition case	syst	system
CHG	charge	T	time
comm	communication	tot	total
EX	exit	U	voltage

Testing Preparation





This section details how to connect all of the test leads and cables properly. Before working with the equipment, be sure to check the following:

1. The battery strings are disconnected from the power supply
(If equipped, flipping the DC breaker on the power supply to OFF will accomplish this.)
2. There is adequate space for testing. Do not test the unit around explosive gas or vapor. Standard load cables are 3m (10ft) in length. Its best to have the load bank as far from the batteries as possible.
3. The nominal voltage of the load bank matches or exceeds that of the battery string.
(Ex. Do not use a 48V unit on a 125V battery system.)
4. There is not an excessive dust buildup on the load bank resistors or other components.
(If there is, blow off prior to powering unit on.)

IMPORTANT: Power supply and control on-off (circuit breaker) should be turned off before making wire connections. To ensure safety, do not turn on the circuit breaker until all other connections are finished.

Standard Cables

This section details connecting the standard test cables. These include the positive & negative discharge cables, string voltage test leads, and AC power cord.

Positive Load Cable		String Voltage Lead	
Negative Load Cable		Power Cable	

Load Cables

***IMPORTANT:** Some models will have (2) of each load cable connection as well as multiple breaker switches. When there are multiple connections and breakers, all connections must be made and all breaker switched must be on.

Before connecting the load cables, the best method of connection for your application should be evaluated. The first method of connection is to use the provided clamp. Attach the discharge cable to the clamp on the bolt as pictured below. The second method would be to directly connect the load cable to the terminal also pictured below.



Disassembled Clamp



Assembled Clamp



Clamp Connection



Direct Connection

SLB Connection Workflow

WARNING: Connect load cables to the load bank before connection to batteries. If connected to batteries first and the ends of the cables touch, an arc flash will occur due to a returned

1. Connect load cables to the back of the load bank and then to the battery bank
2. Connect the voltage sensing leads
3. Optional: If using DAC, connect to battery system
4. Connect antenna
5. Power unit ON
6. Optional: Setup software
7. Flip breakers ON
8. Setup discharge testing parameters and begin test

Connection of load cables

- Connect the locking quick connect of the black load cable with the black port of the load bank and the other end (with clamp or direct bolt) with the negative pole of the battery string.
- Repeat this process with the red load cable by connecting one end of the red load cable with the red port of the load bank and the other end with the positive pole of the battery string.



Connection with Clamps



Connection without Clamps

Connection of voltage test leads

- Connect the round connector of the voltage testing lead to the voltage socket of the load bank, and the other two clamps with the positive and negative poles of the battery string.



Connection of antenna (Optional)

- Screw the antenna into the socket on the top of the load bank. Bend the antenna down at the hinge to reduce the chance of cables becoming caught.

Power supply

- When power supply is from AC, connect the load bank to an appropriate AC power source with the AC power cord. Turn the power switch at the back of load bank to AC 220 (or 110V mains). For special order DC models power supply is from batteries. In that case, power will be supplied via the two load cables.

Breakers

- If your unit is equipped with breakers, flip them into the ON position after powering the unit on, prior to discharging.

Current clamp (Optional)

The following 3 auxiliary functions can make use of the current clamp:

- External discharge:*
Using the load bank during an external discharge. In this scenario the SLB-Series unit functions to display the voltage and current values of the external load being applied to the battery system.
- Assistant discharge:*
An assistant discharge is a function where the SLB supports either another SLB or any other load bank. This function is useful if you already have an existing load bank and would like to increase your discharge amps.
- Charge monitor:*
The purpose of the charge monitor is for viewing the status of the battery bank on float, and recording the recovery of the battery system after a discharge event. To fully utilize this function, both the DAC & CT packages should be purchased.

DAC Connection

The DAC (Data Acquisition Case) is an optional, but fundamental accessory for the Eagle Eye SLB-Series. DACs are used for wireless data logging of each cells voltage in virtual real time. This allows the load bank to capture each individual cells performance throughout the load test to help isolate failed and weak cells. Using the DAC package also allows the user the added safety by being able to utilize the low cell voltage feature of the SLB. When using this feature the user can set a low cell voltage value, where in the event that any cell drops below this cutoff the load test immediately stops for further investigation.

About the DACs: Each DAC is powered by 8VDC from the batteries it is connected to. It attains this from the first 9 connections (7-lead harness) or first connection (3-lead harness). For cable management magnetic bolts are built into the bottom of DAC for attachment to metal surfaces. Each DAC has (2) serial ports for connection with test lead cables. These (2) ports are labeled with “1” and “2” which are connected with red (#1) and black (#2) connectors of DAC cable harnesses.

DAC Test Leads Explained

All standard models of SLB-Series DAC’s can test batteries of 1.2V, 2V, 6V, and 12V cells (1.2V users may need to purchase extra DACs). The DAC kits come with two types of cable harnesses, 3-lead and 7-lead. The 7-lead cable contains (6) red leads and (1) black lead and is used for testing 1.2V (NiCad) or 2V cells. The 3-lead cables contain (2) red leads and (1) black lead and are used to test 6V and 12V cells. Both cable types connect to the battery system and DAC in the same way.

	
<p>7-lead, (1) black and (6) red for testing 1.2V or 2V cells One cable connects to (6) cells; One DAC connects to (12) cells</p>	<p>3-lead, (1) black and (2) red for testing 6V or 12V jars/cells; One cable connects to (2) cells; One DAC connects to (4) cells</p>

Note: It is important to remember that each DAC has (2) serial ports labeled “1” and “2”. The red test lead cable plugs into port “1” and the black test lead cable plugs into port “2”.



Custom DAC kits are available upon request, the most common being 1.2V or 4V applications.

NOTE: For all DAC connections, the first DAC must be connected to the most negative post of the battery string regardless of whether or not the battery string is numbered from positive to negative or negative to positive.

DAC test leads have a set sequence in which they need to be connected to the batteries. Each DAC has (2) serial cables (red & black) and each cable has numbered test leads. The leads are numbered as (0) for the negative lead followed by (1, 2, 3 ...) and so on for each positive lead.

DAC Connection to 2V/1.2V Cells:

- For 2V/1.2V cells, use 7-Lead DAC cables
- Start with DAC cable #1 (red serial connector)
- Connect the black alligator clip (labeled 0) to the most negative post of the battery string
- Connect the red alligator clips (each labeled) to the next (6) positive posts
- Next use DAC cable #2 (black serial connector)
- Connect the black alligator clip (labeled 0) to the next negative post following the previous positive cell connection
- Connect the red alligator clips (each labeled) to the next (6) positive posts
- Repeat connection pattern for additional DAC's

48V System - 2V Cells - 24 Jars

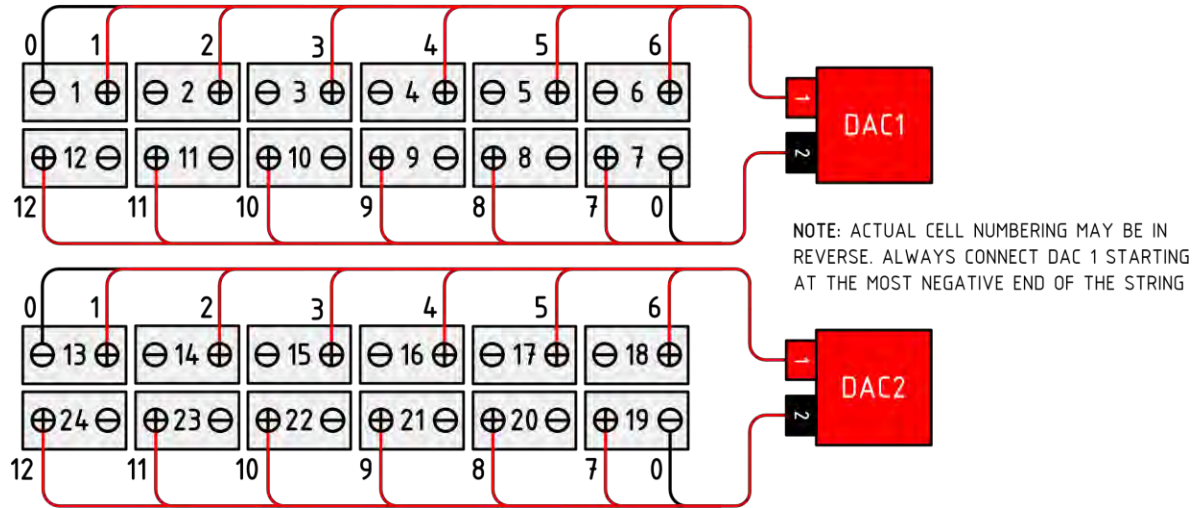

125V System, 2V cells, 60 Units

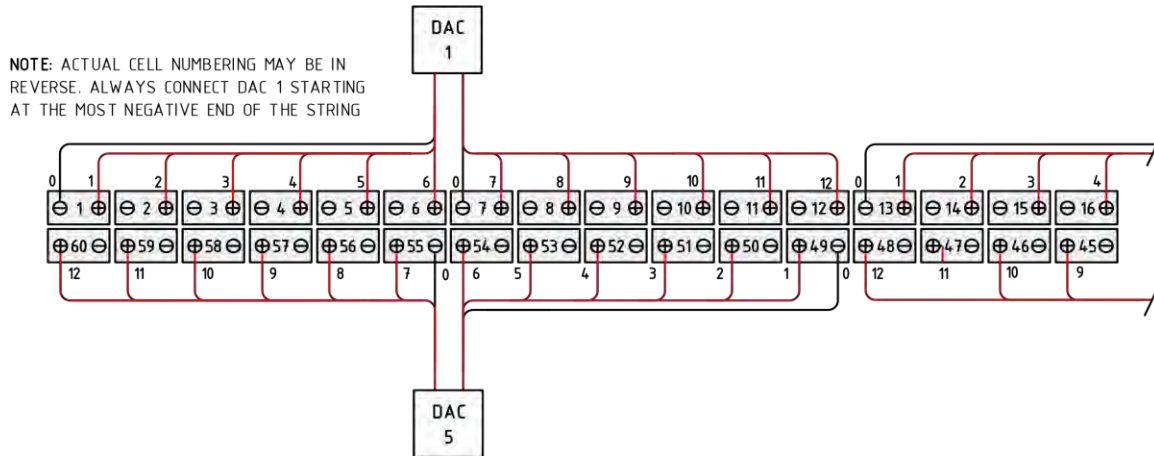

DAC Workflow Connection to 6V/12V Cells:

- For 6V/12V cells, use 3-Lead DAC cables
- Start with DAC cable #1 (red serial connector)
- Connect the black alligator clip (labeled 0) to the most negative post of the battery string
- Connect the red alligator clips (each labeled 1 & 2) to the next (2) positive posts
- Next use DAC cable #2 (black serial connector)
- Connect the black alligator clip (labeled 0) to the negative post after the previous cell connection
- Connect the red alligator clips (each labeled 3 & 4) to the next (2) positive posts
- Repeat connection pattern for additional DAC's

125V System 12V Cells 10 Jars

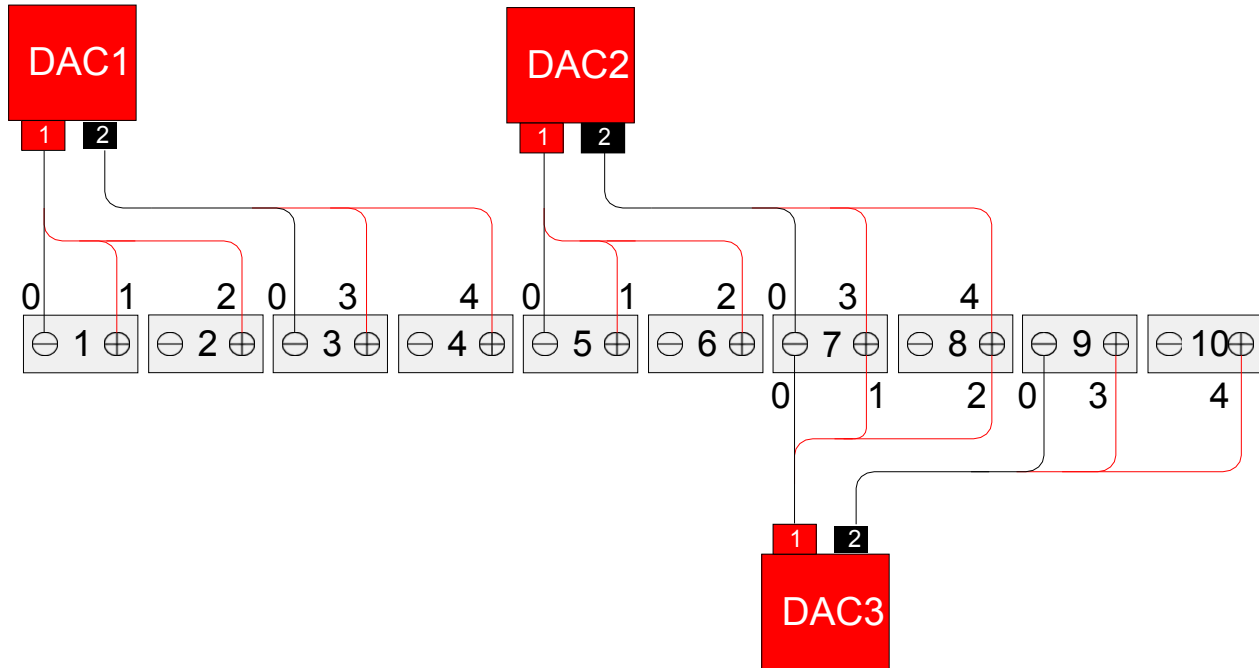

Multiple DAC Notice: If there are more than one DAC and the battery system ends with spare leads on the last DAC, then connection of the last DAC will need to *overlap with the previously connected DAC*. The best method is to take Serial lead #2 (black connector) and start at the last cell of the system (the most positive) with the #12 lead (for 7-point leads) or #4 lead (for 3-point leads) and work backwards towards the previous DAC until you have used all of the lead connections. The next page has a visual example;

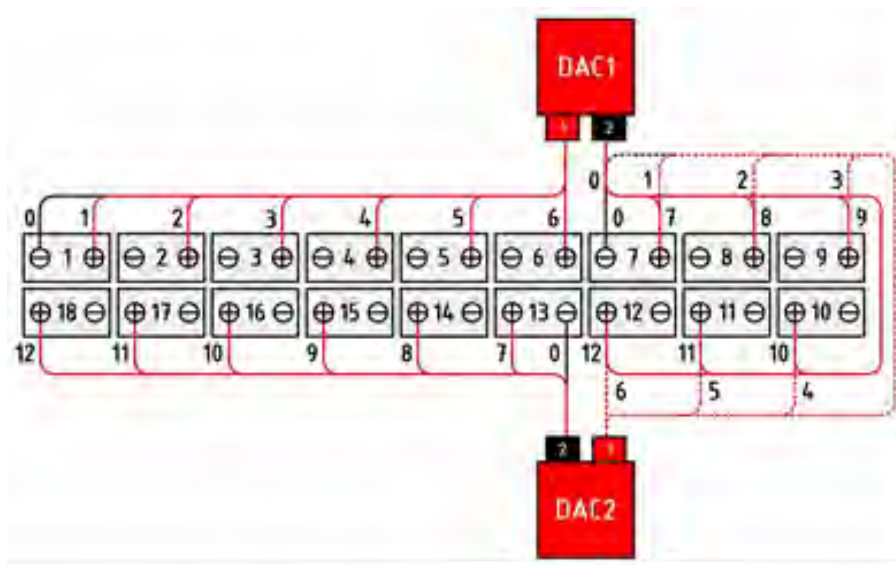

Notice: With DAC #2; the #12 lead is connected to the most positive terminal and the user has worked backwards, eventually overlapping several leads of DAC #1.



Software

All SLB-Series units come standard with the DataView software. With the standard SLB-Series kit the software allows discharge data from the load bank to be analyzed and generate reports. With the DAC package, the DataView software can monitor discharging and charging per cell in real-time.

Installation

Insert your Eagle Eye USB drive that came with your new SLB-Series load bank. On the drive you will find the installation program: Battery DataView Management System

Right click and run install. The installer window will appear. Click Next & confirm installation.

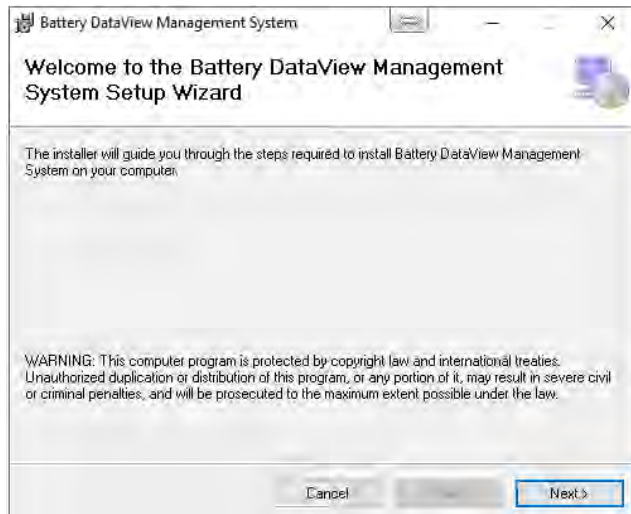

Select the desired installation folder.

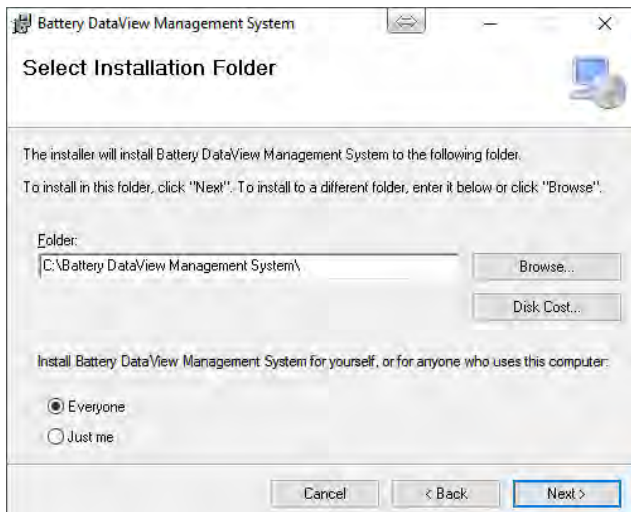

Once installation is complete you will close the installer.

Preparing for Testing

Open the DataView Software.

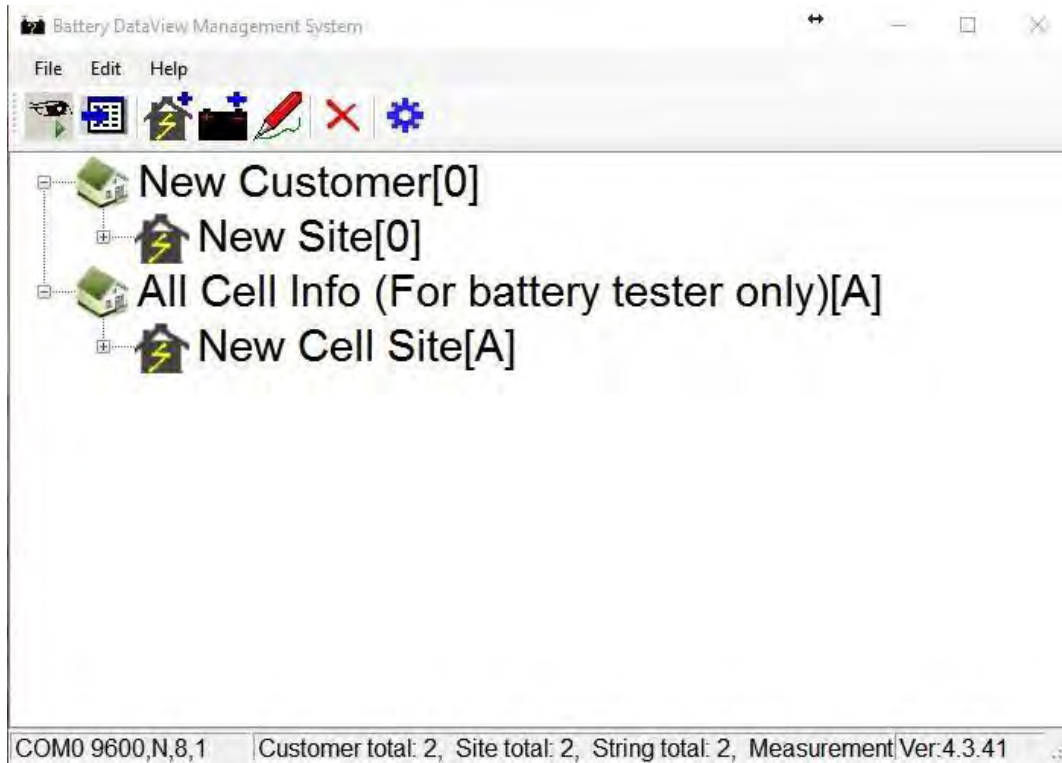

Next, you will connect the Com Terminal to the PC using the provided RS-232-to-USB. Windows may auto install drivers for the device depending on your OS version and security settings. To verify if the drivers have successfully installed go to Start < Device Manager. In Device Manager, if the drivers are installed the Com Terminal will appear under Ports as a USB Serial Port with an assigned com number. In our example the assigned com is 6. Note: Your device assigned Com Port may be different.

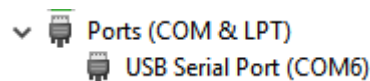

A simple method to determine if the device is on this list is to unplug the USB cord from the PC and then plug it back in. It will disappear & then reappear in the device list. If the device did not properly install (it's not listed in the ports or does not have an assigned port number) you will have to manually install the drivers. When you locate where the driver is right click and select update drivers.





You will receive a prompt box similar to this:



Select Browse my computer for driver software. Go to the USB drive from Eagle Eye.

Select the Com Terminal USB-R232 Drivers folder and press Ok. Windows will install the drivers.

- ▼  Com Terminal USB-RS232 Drivers
 - >  USB1.1 Driver
 - >  USB2.0 Driver

Confirm the Com Terminal is powered on. You should now have an assigned Com Port.

In the DataView software, you will need to select “New String” or you can create your own string. As you see below we have created our own parent company, site, and named our battery string.

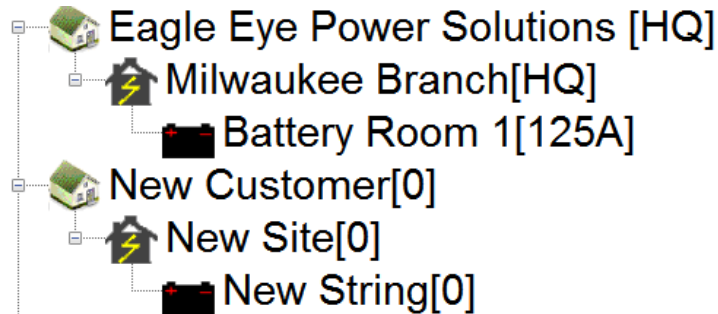

To add a company, go to Edit < Add Customer. Once you have created the customer you can select the newly made customer and “Add Site” in one of three ways;

1. Select the company, right click, choose add site

2. Select the  Icon

3. Go to Edit < Add Site

Once you have created your string or selected the New String option you can go to File < Start Monitoring or press the  icon.

A command box will appear. There are two options. You should click on the picture of your associated product.

At the bottom you will see the Com Port selection bar. Select the Com Port assigned to the Com Terminal from earlier. If needed press the refresh to update the list.

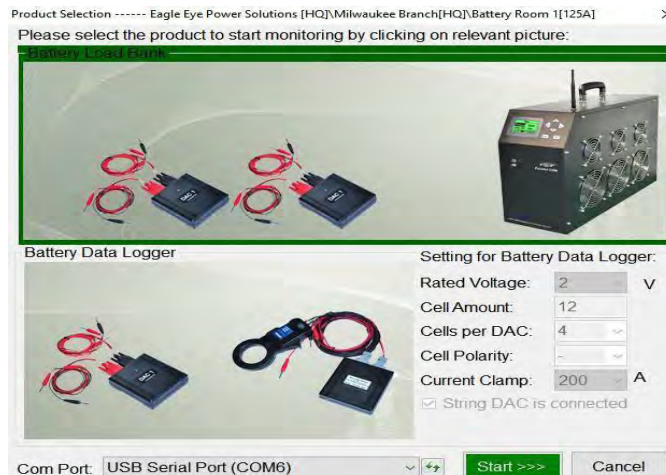



The live monitor screen will now begin and you should start the test with the SLB-Series load bank. **Notice:** The load test cannot be started from the software. You must always start a discharge test on the load bank.

Live Monitoring

When the load bank begins testing the live monitor will show string voltage, discharge amperage, lowest 6 cells, and a chart with all cells on the home “String View” page. Right clicking on any graph allows for editing of the numerical axis values for that graph.

Viewing tabs

String voltage & discharge graph

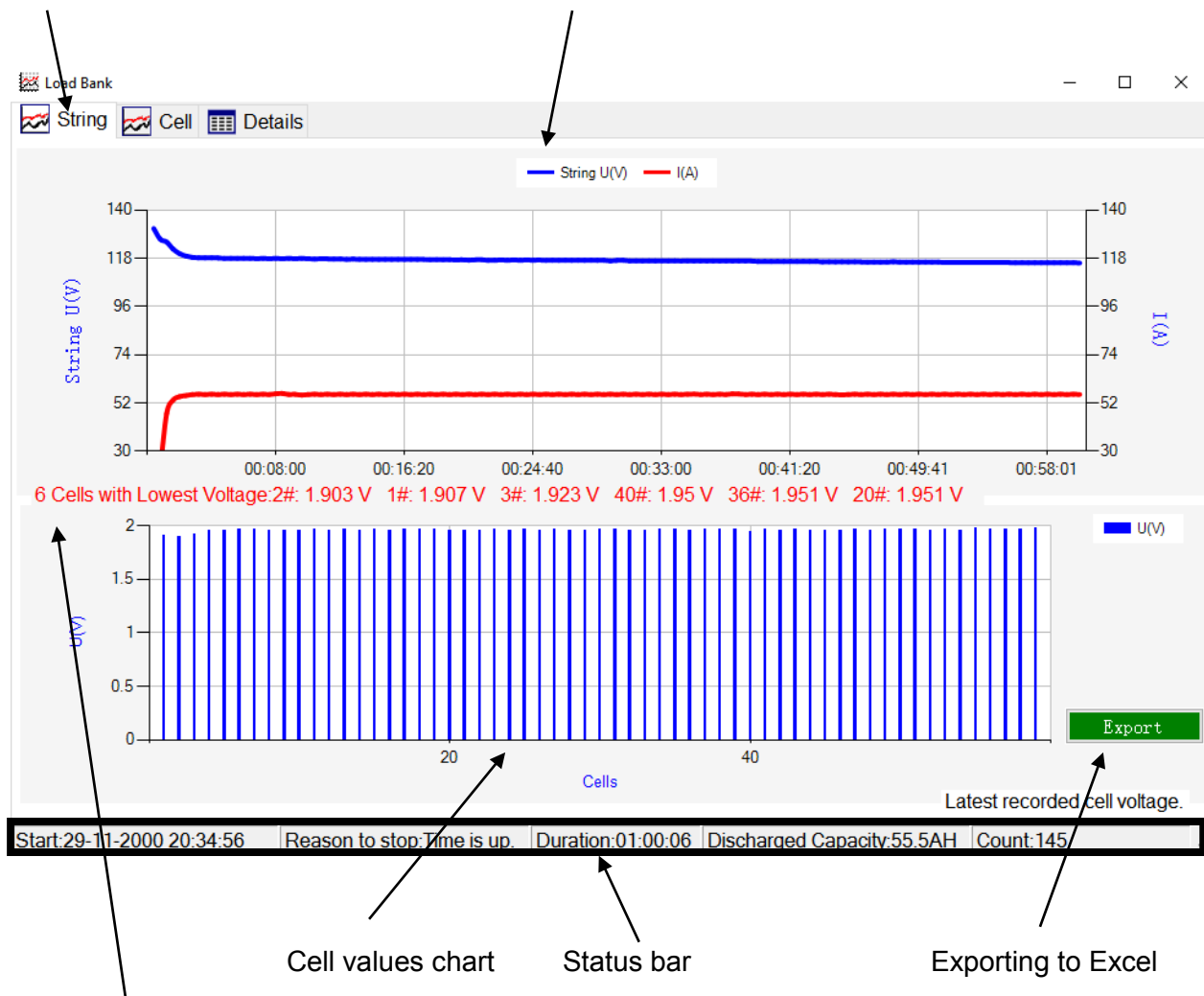

Display of 6 lowest cells

Cell view allows you to choose individual or all cells

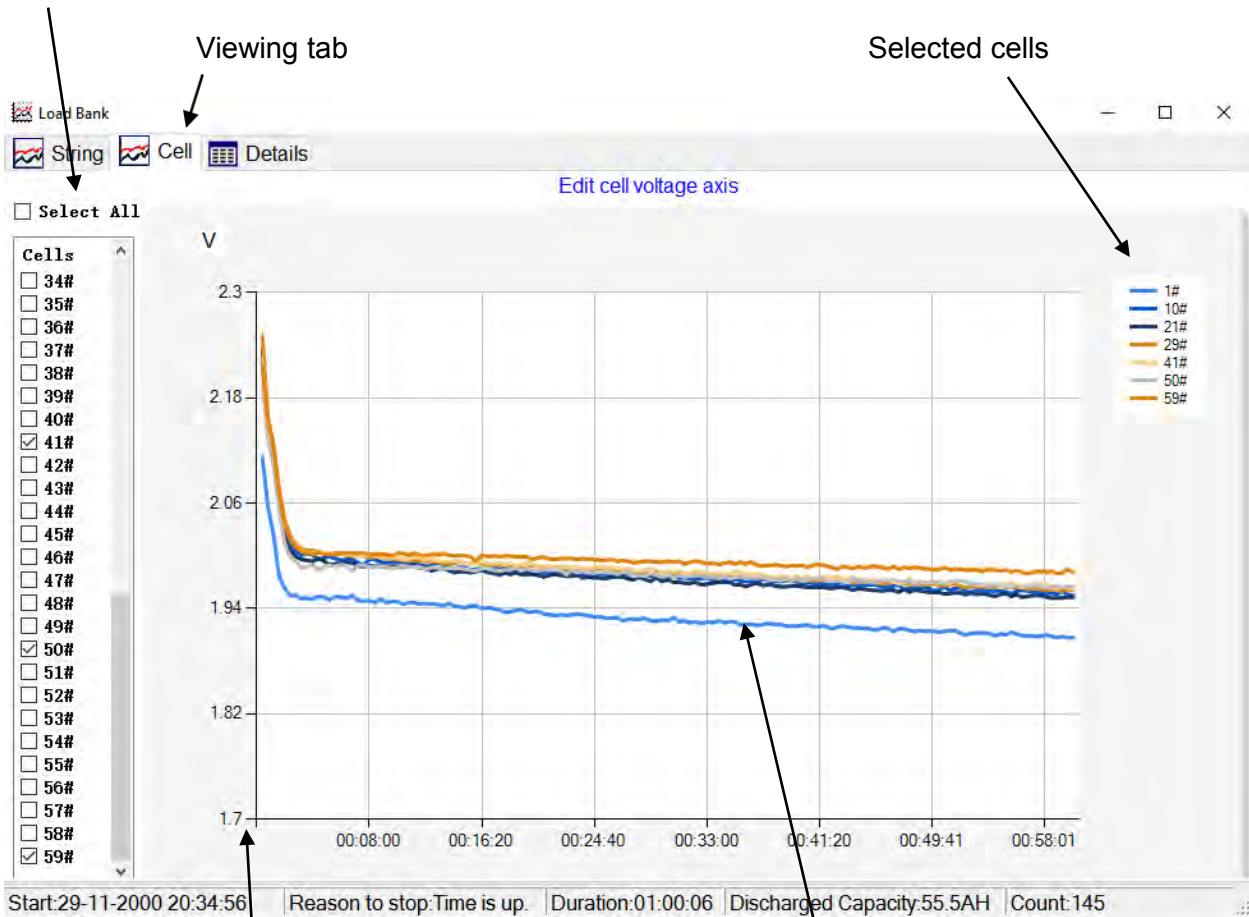

Adjustable chart graph

Hover over any line for cell number and voltage



Detailed View lists the discharge data in numerical values at approximately fifteen to half minute intervals.

Values displayed; Time (date), Duration, String voltage, Discharge current, and each cell's voltage.

Selecting any data point will be reflected in the chart at the bottom of the screen. Hovering over any bar on the chart will display the corresponding cell number and its voltage value. The voltage axis lowest and highest value can be modified for viewing.

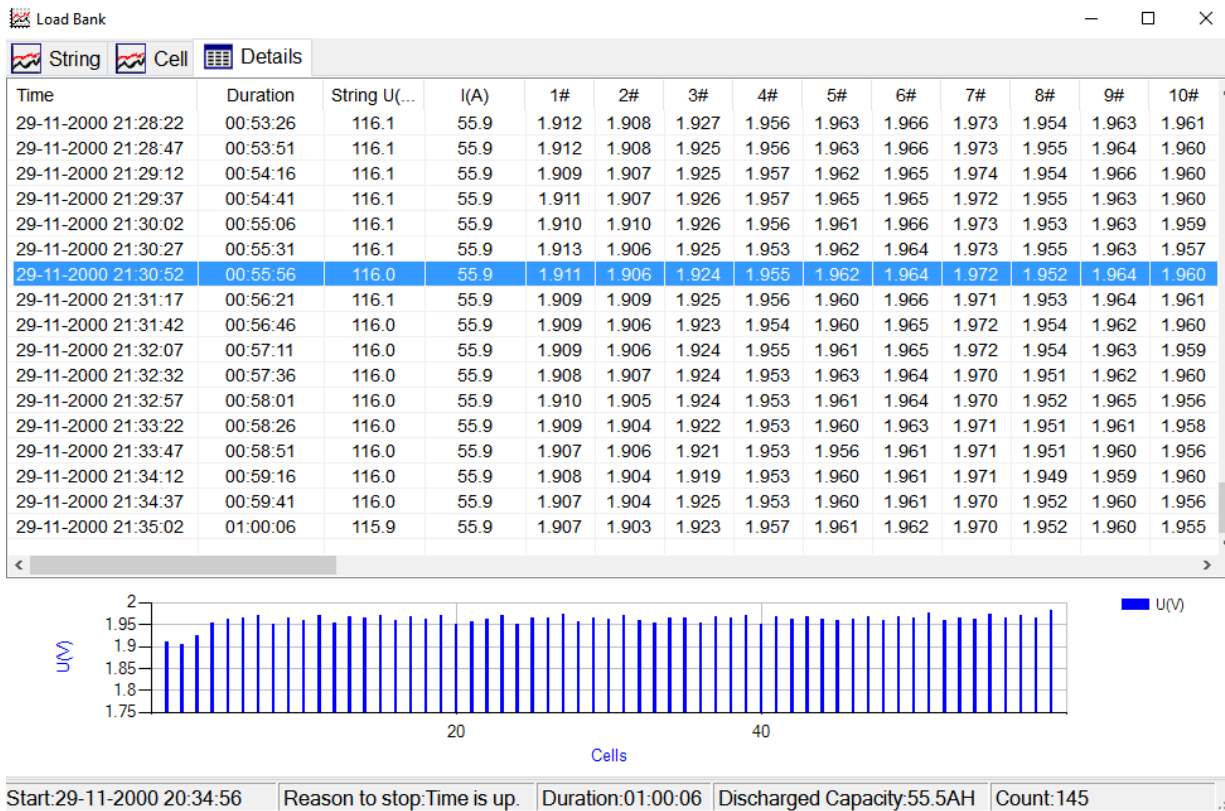

Exporting Data

It is not necessary to live monitor a discharge to be able to view data. All discharge tests are stored on the SLB-Series load bank upon test completion. You should insert the Eagle Eye (or other) USB flash drive into the USB port of the SLB load bank. With the SLB go to Data > View Data > Select the appropriate test from the list & choose “write to USB”. Once completed, you can now insert the USB drive into your PC USB port.

With the DataView software either go to File > Import or click the  icon. The import box will appear;

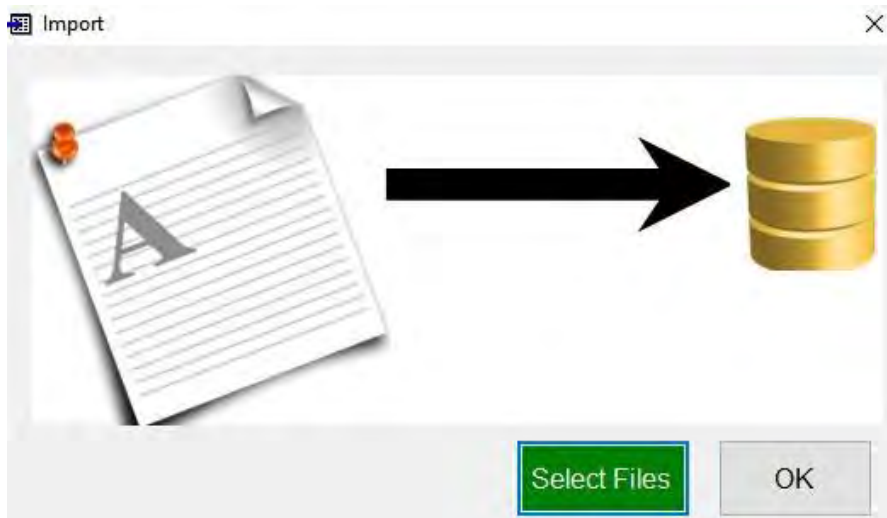

Go to “Select Files” and find the USB drive on your computers directory. Once importing is completed you will see:

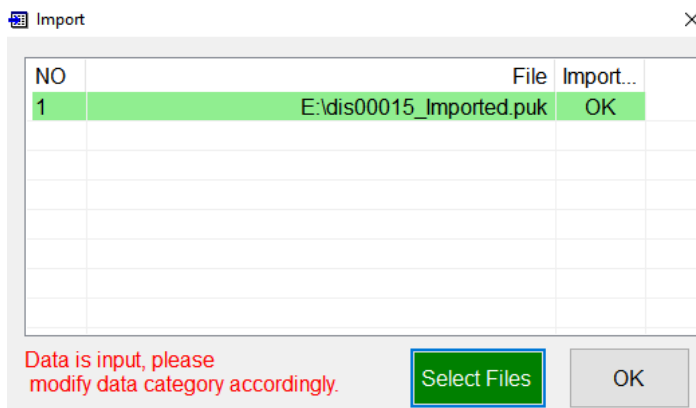

You can choose to select more files or press OK to complete the import.



Once imported, you will see the imported data on your list. Double click on the newly imported string and you will receive the test selection box;

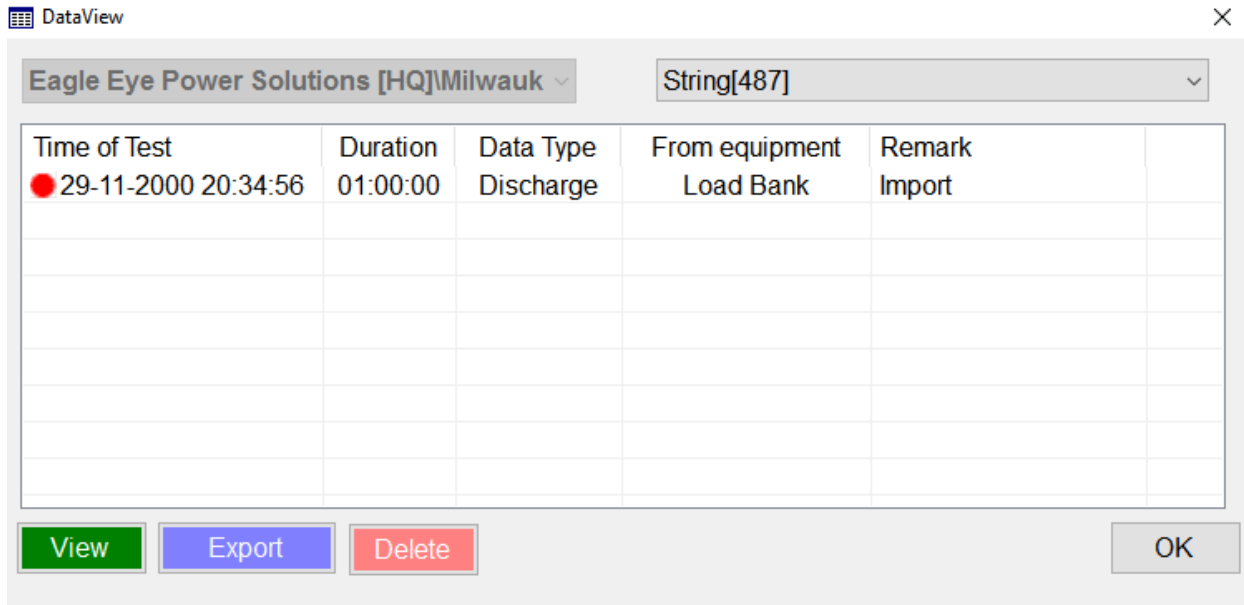

Select the test you wish to work with and then select either View – to view data, Export (to Microsoft Excel), or delete.

View data will bring up the Live monitor screens previously covered. Export will bring up a command box with time interval selection of either 15, 30, or 60 minute intervals.



Once Export is selected an Excel file will be generated. **Note:** The user will need to have Microsoft Excel installed on the PC for the Exporting function to complete.

Discharge Testing

The following section covers steps for performing a discharge test. For an additional tutorial of the SLB-Series menu, please visit our tutorial video [SLB Menu Walkthrough](#)

Battery String Discharge

Using the keypad and LCD display, press the arrow keys up/down to highlight **[Discharge]** and press **ENT** to open the discharge test parameter screen.

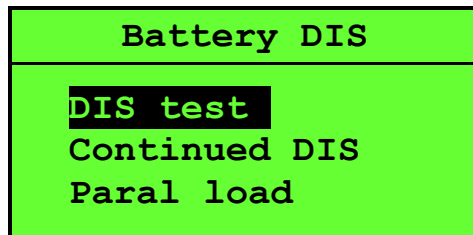

Discharge Menu

Discharge Test Parameters

There are four system parameters to set for a discharge test. These settings vary slightly depending on whether or not the test will include the use of DACs.

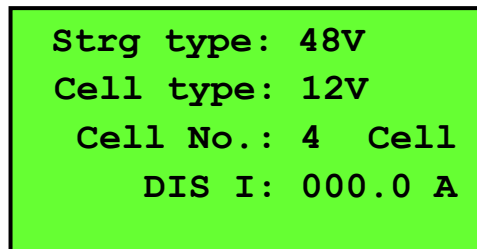

Discharge Parameters

Use the **left/right** arrow keys to adjust the following values:

- [Strg type]:** Refers to the total voltage of the battery string/system
- [Cell type]:** Refers to the nominal cell voltage
- [Cell No.]:** Refers to the number of cells in the battery string, **if not using DAC set this value to "0"**
- [DIS I]:** Refers to the working current to be applied to the system

After setting the discharge parameters, press the **down** arrow key to progress to the next screen.



Cut-off Parameters for Discharge Auto-stop

There are four user defined parameters for setting the discharge auto-stop. If *any* of these parameters are met the discharge test will end.

```
Tot end U: 43 V
Cell end U: 10.80V
DIS C: 0000 Ah
DIS Time: 10H 00M
```

Parameters for Discharge Auto-Stop

Use the **left/right** arrow keys to adjust the following values:

- [Tot end U]:** Indicates the total low-voltage cut-off for the battery string/system
- [Cell end U]:** Indicates the low-voltage cut-off of individual battery cells
- [DIS C]:** Indicates the capacity removed cut-off of the battery string
- [DIS Time]:** Indicates the time duration of the discharge test

Common Voltage Cutoff Values (Reference only, verify with your battery's manufacturer):

Voltage value multiplied by (0.9)

- 1.2V = 1.08V
- 2V = 1.8V
- 6V = 5.4V
- 12V = 10.8V

After setting the cut-off parameters, press the **down** arrow key to progress to the next screen.

First Cell Polarity

The First Cell Polarity setting is used for DAC communication only. It is used to indicate which end of the battery string, positive or negative, you have labeled as cell #1. *Regardless of the how the battery string is labeled DAC#1 always needs to be connected to the negative end of the string.*

When to use negative setting:

If the first battery in the string starts at the negative post, then DAC#1 will be connected to this battery and the setting will be left as negative. When the test starts DAC#1 will correctly display the first battery of the string as Battery #1.



When to use positive setting:

If the first battery in the string starts at the positive post, then DAC#1 will be connected to the last battery of the string and the setting will be set to positive. When the test starts DAC#1 will display the last battery of the string correctly as the last battery and not the first.

If this setting is incorrect, the voltage readings of the cells will be reversed.

Starting a Discharge Test

When all of the discharge settings are set the discharge test can begin. When starting the test, a 60 second countdown can be enabled (system settings). Several events can occur during this time:

- If using the DataView Management Software the system information starts to populate.
- If the total system or cell voltage is lower than the cutoff threshold, the test will not start.
- If there is not enough memory on the unit to record another test, a memory error will appear.

```
DIS prepare, wait 55S
DIS C:      0.0Ah
  U: 0.0V  I: 0.0A
Min cell:001# 2.001V
```

Discharge Countdown

Using the arrow keys up/down it is also possible to view individual cell voltages. (DAC only)

001#2.001V	001#2.001V
001#2.001V	001#2.001V
001#2.001V	001#2.001V
001#2.001V	001#2.001V

Display of Cell Voltages



During the Discharge Test

During the discharge test the following parameters will be displayed:

- [Time]**: Total and remaining time left on the test
- [DIS C]**: String capacity discharged from batteries
- [U]**: Indicates total voltage of string
- [I]**: Indicates discharge current
- [Min cell]**: Indicates cell # and voltage reading of lowest cell

Time	00:00:04/10:00
DIS C: 0.0Ah	
U: 0.0V I: 0.0A	
Min cell:001# 2.001V	

Test Display during Discharge

DAC Replacement

If at any point during use a DAC error occurs or is suspect of malfunction, it can be replaced using a spare DAC.

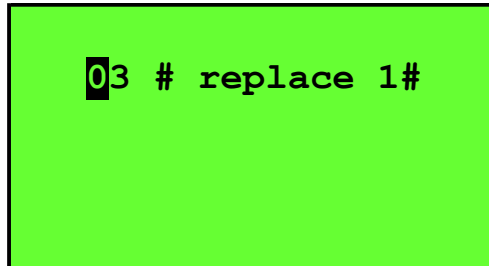

DAC Replacement (DAC#3 to replace DAC#1)

To replace a faulty DAC

1. Unplug the faulty DAC
2. Plug in replacement DAC
3. Enter the number of the spare DAC (after starting the test) and press **ENT**

NOTE: Replacing a DAC will reprogram its number. If DAC 3 replaced DAC 1, then DAC 3 will become DAC 1. This can be reversed by plugging the original in and reassigning it the default number.

Discharging of Strings in Parallel Connection

Parallel battery strings of the same nominal voltage can be discharged together. One SLB load bank can discharge up to five battery strings connected in parallel.



Preparation

1. Ensure that all systems and cells are of the same voltage and amp hour capacity.
2. Be sure that DACs are grouped per string (buying additional DACs may be necessary)
3. Connect the load cables and string voltage leads to the main positive and negative posts of the strings in parallel
4. Connect the DACs with each battery string in the sequence of String 1 (DAC #1, #2...), String 2 (DAC #1, #2...) and so forth. When running the discharge test, certain DACs may need to be reassigned. (For example: DAC #1 & #2 connect to string #1. DAC #3 & #4 connect to string #2. When running the test, DAC #3 & #4 will need to be reassigned as DAC #1 & #2 because the 2nd string is independent of the 1st string.

Function Setting

Before doing a parallel discharge test the function settings of the load bank. The SLB needs to be configured for operation with parallel systems.

1. Select **[System]** under the main menu then select **[Function]**
2. Set **“Parallel”** to **“2”** from the default setting of **“None”**
3. If using DAC, set **“Str Grouped”** to **“Yes”**

Operation

After setting up the load bank for a parallel test, the discharge menu will add options for a parallel load test. From the main menu, select **[DIS test]** to configure the settings for the battery strings.

Setting up battery strings (systems)

Use the **right/left** arrow keys to adjust the values then press **ENT** to start discharging.

- **[Strg type]:** Nominal string voltage (certain models may only have (1) nominal voltage type selectable. i.e. a 125-100 unit does not have “48V” as an option, but can still test a 48V system)
- [String]:** Number of strings in parallel test. 1 SLB can do up to (5) strings
- [String No.]:** String number in parallel system
- [Cell Type]:** Nominal voltage of cells
- [Cell logged]:** Quantity of cells in selected string

Strg type: 48 V	Strg type: 48 V
String: 2	String: 2
String No.: 1	String No.: 2
Cell Type: 12V	Cell Type: 12V
Cel logged: 04 Cell	Cel logged: 04 Cell

First String

Second String

1. Set the parameters for the first string, “**String No.**” indicates current string
2. Change “**String No.**” from “**1**” to “**2**” and so on to change parameters for each string
3. Press the **down** arrow to set parameters for the parallel strings
4. Press **ENT** to start the test.

Continued Discharge

It is possible to continue a discharge test that has stopped for various reasons such as cutoff values met or manual stop. To continue a stopped discharge:

1. Enter the menu and select [**Battery DIS**] then select [**Continued DIS**]
2. If the test was stopped due to cells with low voltage, then a maximum of 6 cells can be ignored so that the test can continue. **NOTE:** Ignored cells will still be discharged unless removed from the string. It is recommended to adjust the overall system voltage cut-off to reflect the number of cells removed.
3. Press **ENT** to start the continued discharge.

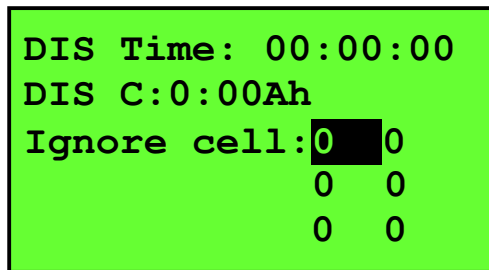

```
DIS Time: 00:00:00
DIS C:0:00Ah
Ignore cell: 0 0
              0 0
              0 0
```

Ignore Cells with Low Voltage

Parallel Load Test

If the required discharge current is higher than the rated value of the load bank another SLB-Series load bank of the *same nominal voltage* can be used in parallel to increase the discharge current. **NOTE:** *Only units with the same nominal voltage rating can be used in parallel.* For example, a 48V 100A and a 48V 200A load bank can be used in parallel to discharge up to 48V 300A.





Parallel Connection

Performing a Parallel Load Test

1. Connect the two SLB-Series units using the serial cable, one unit will act as the main unit and the other as assistant unit
2. With both units select **[System]** under the main menu then select **[Function]**. Set both SLB units “**Parallel**” to “**2**” from the default setting of “**None**”
3. Connect all cables including DAC (if applicable) from the main unit to the batteries
4. Connect load cables and voltage leads from the assistant unit to the batteries, do not use DAC with assistant unit
5. Turn on the assistant unit but do not set any parameters
6. Turn on the main unit, select **[Battery DIS]** from the main menu and setup the discharge test parameters (like you would for a regular discharge). The upper limit for discharge current will have increased to the sum of both unit's rated currents. Once you start the test, the assistant unit will automatically provide the additional current needed for the test, and will display this value on-screen.

Other Tests

Assistant Discharge Test

“Assistant discharge” is an auxiliary discharge to external discharge. This function is used when batteries are connected online with other loads. You will need to purchase the optional current clamp for this feature. Current range of clamp should be based on external loads, generally of the same range or a little higher than external load current. When batteries are connected with other loads (running equipment), current clamp can be used to test the amps discharged from the batteries.

An example of this feature is if the other loads are discharging 10 amps from the batteries and but your target is to discharge 25 amps, you could use the assistant discharge to handle the remaining 15 amps.

To perform an assistant discharge:

1. Select **[Assistant DIS]** in the **[Other test]** menu.
2. Set discharge parameters
3. On the last screen where first cell polarity is set the ampere of the **clamp type** will need to be entered
4. Set the clamp type to the same value as set for the discharge current.
5. Press the **ENT** button to start the discharge test



External Test

External discharge test means that the load bank does not discharge batteries. Its main function is to display the values of current clamp and other loads (including battery string). Except battery total voltage and cell voltage (if connected with DAC), all the other values displayed on screen are from outside loads. The goal of this test is to use the SLB-Series load bank as a battery data logger.

To perform external discharge:

1. Select **[External test]** in the **[Other test]** menu
2. Set discharge parameters as explained in **section 5.2**
3. Press the **ENT** button to start the test

Charge Monitor

Charge monitor is a supplemental function for monitoring data when using an external charger for a battery string. Similar to external testing the SLB is acting as a battery data logger.

To start the charge monitor:

1. Select **[Charge Monitor]** in the **[Other test]** menu
2. Set the following string parameters:
 - **[Strg type]:** Indicates nominal voltage of the battery string
 - **[Cell type]:** Indicates cell voltage
 - **[Cell No.]:** Indicates number of cells
 - **[Time]:** Indicates time to monitor charge

```
Strg type: 48 V
Cell type: 2V
Cell No.:24
Time: 10H 00M
```

Parameter Settings

3. Set the following monitor parameters
 - **[Clamp type]:** Indicates current rating of clamp
 - **[Tot warn U]:** Indicates upper limit of total voltage
 - **[Cell warn U]:** Indicates upper limit of cell voltage
 - **[1# cell polar]:**

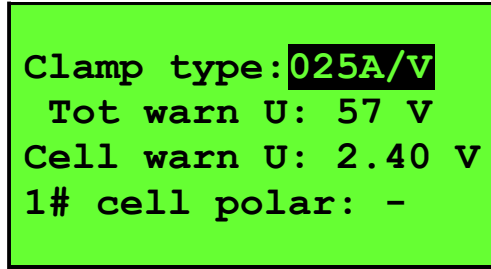

Monitor Parameters

4. Press **ENT** to begin monitoring the charge

SLB Disconnection Workflow

NOTE: When a discharge test has completed, it is recommended that the SLB-Series unit be left on to cool for 10 minutes. Immediately powering off the unit will not allow the fans to properly cool down the internal components prior to storage.

Follow the steps below for proper take down of the SLB-Series test setup:

1. Flip the circuit breaker to the OFF position
2. Power off the unit
3. Disconnect power cord from load bank
4. Disconnect load cables from the batteries
5. Disconnect load cables from the load bank
6. Disconnect the voltage cable first from the battery and then from the load bank
7. Remove current clamp or serial cables if applicable
8. Disconnect DAC
9. Disconnect antenna

Data Management

All test data is saved to internal memory on the unit. This data can be directly viewed on the screen or transferred to a USB drive and viewed in the Dataview software.

To view test data:

1. Select **[Data]** in the main menu
2. Select **[View Data]** and then select **[DIS data]** to display all of the test dates
3. Select a date, press **ENT** and then select **[View]** to display test data

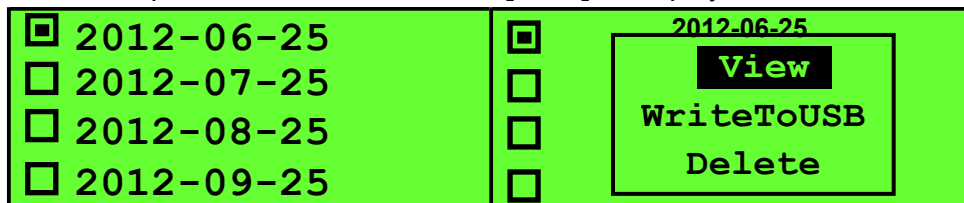

Test Dates

View Test Data

Transferring Data to USB

1. Plug a USB flash drive into the front of the unit
2. Select a test date and chose **[WritetoUSB]**
3. Press **ENT** to transfer the test data to a USB flash drive

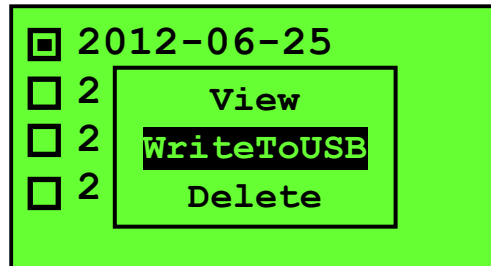

Delete Test Data

1. Select a test date and chose **[Delete data]**
2. Press **ENT** to delete the test date

Format Data

1. Select **[Format]** under the data menu
2. Enter the (**password 1234**) to format the unit's memory

NOTE: Formatting the unit will permanently erase all test data.

System Management

System management is used to change the system time, manage parameters, calibration, as well as set various functions.

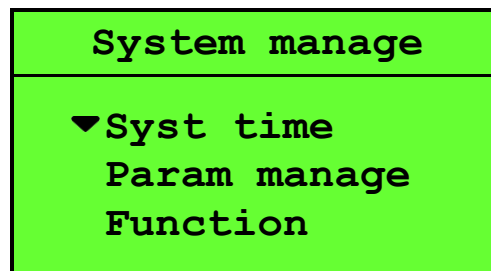

System Management



Time and Date Setting

Setting the system time and date correctly should be done before any discharge tests are performed.

To set system time:

1. Select [**Syst time**] under the [**System manage**] menu
2. Use the **up/down** arrow keys to change number orientation
3. Use the **left/right** arrow keys to change number values
4. Press the **ENT** button to save the time/date setting

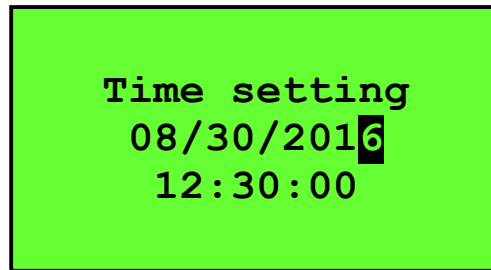

Parameter Management

Parameter management is used for various calibration and parameter settings.

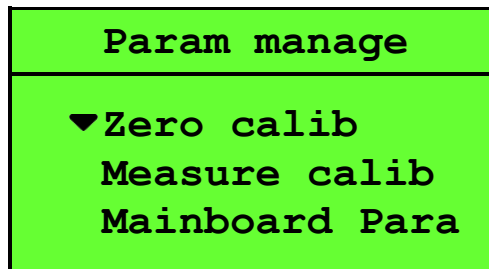

Parameter Management Menu

Zero Calibration

To ensure measurement accuracy, zero calibration should be performed when the load bank was unable to collect discharge voltage and current in normal operation.

To perform zero calibration:

1. Disconnect all measurement cables from the load bank and batteries
2. Select [**Zero calib**] under the [**Param manage**] menu
3. Press the **ENT** button to start calibration

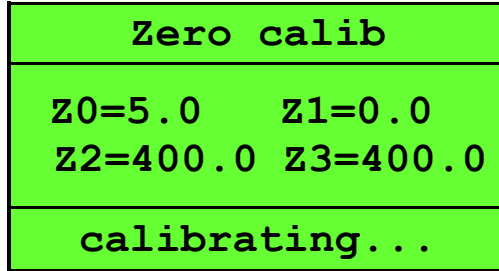

Zero Calibration

After the zero calibration is complete the values should be as follows:

Z0: Between 5 and 25

Z1: 0.0

Z2: Between 400 and 600

Z3: Between 400 and 600

Measurement Calibration

This function is used to calibrate voltage and current values. (**Password: 9577**) For a string voltage calibration, an accurate multi-meter is needed.

Select [**Measure calib**] under the [**Param manage**] menu to select a calibration method.

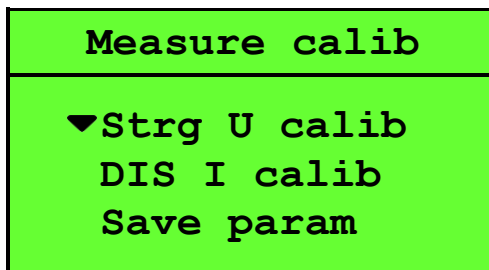

Calibration Menu

To perform a String Calibration:

1. Select [**String U calib**]
2. Connect the string voltage test leads to the poles of the battery string
3. Select the nominal voltage of the string, this value should be identical to the nominal voltage of the load bank

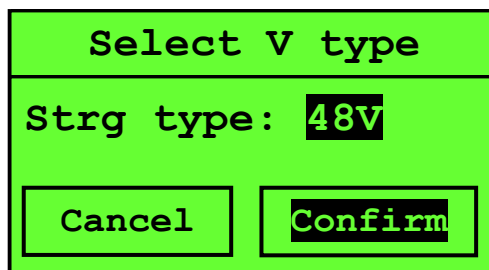

Select String Voltage



4. Using a multi-meter, test the actual string voltage and enter this value under **[Real U]**
5. Press **ENT** to calibrate the string voltage

To perform a Discharge Current Calibration:

This option calibrates inner current and outside current. Inner current calibration is for the built-in current sensor, while outside current calibration is for optional external current clamp. For current calibration, you will need an adjustable current clamp as current standard.

Inner Current Clamp Calibration:

1. Select **[Inner I calib]** in the **[Measure calib]** menu
2. Connect the adjustable current clamp on the red or black load cable
3. Press the **up** arrow on the load bank panel until the current value in current clamp is higher than 70% of load bank maximal discharge current. For example, for a load bank of 48V 300A, the current value in the standard current clamp should be higher than 210A.
4. Use the **left/right** arrow key to input the current value in **[Real I]** (from the current clamp equipment) to modify the load banks **[Test I]** value.
5. Press **ENT** to calibrate

I calib
Test I :
Real I : 30.00 A
Coef.: 1.000

Inner Current Calibration

External Current Clamp Calibration:

1. Select **[Outside I calib]** in the **[Measure calib]** menu
2. Connect the optional current clamp to the red or black discharge cable
3. Input the current value in **[Real I]**
4. Press **ENT** to calibrate

I clamp calib
Test I :
Real I : 50.00 A
Coef.: 1.000

External Clamp Calibration

**Save Parameter:**

After performing any of the above calibrations select **[Param save]** to save the calibration setting. (Password: 9577)

Function Settings

The function menu is used to change Alarm, Parallel Load, Prepare Time, Restore Time, Company, DAC Type, and String Group settings.

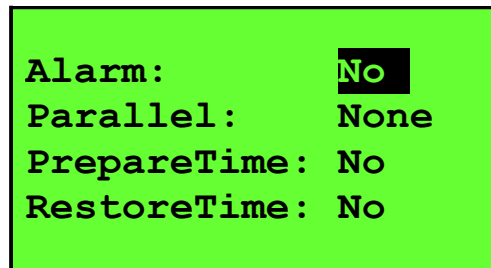

Function Menu

Description of each function:

- **[Alarm]:** Notifies user when discharge test is complete using a BEEP sound
- **[Parallel]:** Allows for discharge using two SLB load banks in parallel.
- **[Prepare Time]:** When set, a minute of prepare time is given before any discharge test performed.
- **[Restore Time]:** When set, a minute of restore time is given after completing a discharge.
- **[Company]:** Allows you to specify company information for any discharge test.
- **[DAC Type]:** Sets DAC cell voltage type. **NOTE:** For all standard DACs, this should always be set to [1.2, 2, 6, 12V] in order to have proper communication to the DACs.
- **[Str Grouped]:** Used to set parallel strings using DAC. These DACs are grouped to fit different strings in the way of String 1 (DAC 1, 2...), String 2 (DAC1, 2...) and so forth. For detailed discharge instructions please refer to the parallel testing section

Service & Maintenance**Cleaning**

To clean Eagle Eye SLB-Series load banks simply wipe the units down with a damp cloth and mild soap. Do not use abrasives, solvents, or alcohol as they can deform and or discolor the unit. Occasionally, the load bank and its components should be blown off with air to remove dust buildup from the mosfets and control boards. Do not apply extreme psi directly onto the boards when cleaning.

NOTE: Be sure to unplug all cables before cleaning the unit.

Storage

Store all Eagle Eye SLB-Series units in a cool, well ventilated place with relatively low humidity. If the unit came with a case, store it in the case whenever the unit is not in use.



Calibration

Eagle Eye recommends having the unit serviced periodically (2 years generally) to verify the unit firmware and components are calibrated and operating effectively.

Troubleshooting

See below for solutions to common troubleshooting scenarios:

The LCD display on the front of the unit does not turn on

1. Check the fuses and power supply
2. Check the LCD cable connection to main PCB board

Discharge function stops immediately after startup

1. Check the parameter settings to make sure that none of the measured voltages are out of the set cutoff value
2. Check connection of test leads
3. Check that all breakers are in the ON position
4. Calibrate unit

Load bank fails to communicate with PC

1. Check connection of COM terminal and that it is powered on
2. Check to ensure the Com Terminal is correctly installed in the device manager and take note of the COM Port number
3. Check in the software that the COM port number is set to the same as the PC
4. Check that the Com Terminal and Load Bank antennas are attached and open the Dataview software

"1 Channel Abnormal" displays after starting a discharge test

1. The discharge breaker switch on the back of the unit is in the "OFF" position, switch ON
2. Internal CT is malfunctioning, check connections
3. Lose cabling from MOSFETS to breakers, check connections
4. Lose or improper load cable connections to battery bank, check connections
5. Main PCB or driver PCB malfunctioning, contact Eagle Eye



Error Codes

Category	Title	Error details and possible causes
File operation	File exist	The USB has the file with the same name
	Open err	Unable to open the file in the USB
	Not USB	Unable to identify USB
	Create file err	Create file unsuccessful to the USB
	Save file err	Save file unsuccessful to the USB
	Save alloc err	The USB's FAT operation failed
	Save Error	The native file save error, file length etc.
	Version Error	The current version cannot view the native storage file. Version without grouping cannot view the storage data files with grouping version. Vice versa.
	Memory Full	The native storage space is not enough to store the setting time data file as discreet value
Parallel communication	Set paral load fail	The discharge communication between the loads failed
	load failure	Communication before discharging with the load failed and/or parameter setting is incorrect or met
	Load Total U too high	Detected total voltage of load before discharge is greater than the maximum voltage limit
	Total batteries voltage inconformity	Detected total voltage of load before discharge is not in the host's current selected voltage type
Extension communication	DAC error	communication with the Com Terminal failed
Parameter setting	Set Error	parameter setting value and save values are not consistent.
	Coefficient Error	Calibration coefficient of deviation is too large
	Total U too high	Detected before discharge total voltage is greater than the maximum voltage limit
	U low	Total voltage detected before discharge is less than the total end voltage value parameter setting



	Voltage mismatch	total voltage detected before discharge is beyond the scope of the currently selected voltage type
Other	I channel abnormal	Current cannot be discharged. This is due to breakers being turned in the off position or damaged parts



APPENDIX A: General Specifications

Technical Specifications	
Cell Voltage:	Standard DAC: 1.2V ¹ , 2V, 6V, 12V / Optional: Custom DAC configurations available upon request
Discharge Current Range:	Single Load: 12 – 600A / Parallel Load: Up to 1200A
Discharge Voltage Range:	Range: 10 – 576V (Max) / Voltage Steps: 12V, 24V, 36V, 48V, 80V, 125V, 240V, 380V, 480V
Accuracy:	Discharge Current: 1% / Voltage: 0.5% – 0.8%
Resolution:	Discharge Current: 0.1 A or 0.5% / Voltage: 0.001 V
Sampling Interval:	5 seconds – 1 minute
Data Transfer:	USB, Wireless (466 MHz)
Display:	Backlit LCD
Operating Environment:	0 – 40 °C (32 – 104 °F)
Power Requirements:	110/220 VAC 50/60 Hz / DC (from connected batteries)
Dimensions:	Small: 400 x 177 x 288 mm (15.7 x 7 x 11.3 in) Medium: 520 x 202 x 355 mm (20.5 x 8 x 14 in) Large: 555 x 225 x 435 mm (22.5 x 8.9 x 17.2 in) X-Large: 603 x 400 x 740 mm (23.7 x 15.7 x 29 in) XX-Large: 762 x 406 x 737 mm (30 x 16 x 29 in)
Weight:	Small: 11 kg (24 lbs) Medium: 16 kg (36 lbs) Large: 21 kg (47 lbs) X-Large: 42 kg (93 lbs) XX-Large: 55 kg (122 lbs)



APPENDIX B: Discharge Specifications

		Maximum Discharge Current At:									
No	Model	12VDC	24VDC	28VDC	36VDC	48VDC	80VDC	125VDC	240VDC	380VDC	480VDC
1	SLB-12/24-400	400	400	--	--	--	--	--	--	--	--
2	SLB-24-300	--	300	--	--	--	--	--	--	--	--
3	SLB-24-400	200	400	--	--	--	--	--	--	--	--
4	SLB-24-500	250	500	--	--	--	--	--	--	--	--
5	SLB-24/36-100	50	100	77.7	100	--	--	--	--	--	--
6	SLB-24/36-300	150	300	233.3	300	--	--	--	--	--	--
7	SLB-24/36/48-300	150	300	233.3	300	300	--	--	--	--	--
8	SLB-24/36/48/80-200	--	200	--	200	200	200	--	--	--	--
9	SLB-24/48-200	--	200	--	200	--	--	--	--	--	--
10	SLB-24/48-300	150	300	175	225	300	--	--	--	--	--
11	SLB-24/48-300/600	150	300	350	450	600	--	--	--	--	--
12	SLB-24/48-600	300	600	350	450	600	--	--	--	--	--
13	SLB-28-100	40	80	100	--	--	--	--	--	--	--
14	SLB-28-150	60	120	150	--	--	--	--	--	--	--
15	SLB-28-300	120	240	300	--	--	--	--	--	--	--
16	SLB-28-500	200	400	500	--	--	--	--	--	--	--
17	SLB-48-150	--	--	--	--	150	--	--	--	--	--
18	SLB-48-300	75	150	175	225	300	--	--	--	--	--
19	SLB-48-400	--	--	--	--	400	--	--	--	--	--
20	SLB-48-500	125	250	290	375	500	--	--	--	--	--
21	SLB-48/125-100	25	50	58	75	100	64	100	--	--	--
22	SLB-48/125-200	50	100	116	150	200	128	200	--	--	--
23	SLB-48/125-300	75	150	174	225	300	192	300	--	--	--
24	SLB-48/240-100	25	50	58	75	100	33	52	100	--	--
25	SLB-10-288v-200A	50	100	116	150	200	50	75	150	--	--
26	SLB-80-100	15	30	35	45	60	100	--	--	--	--
27	SLB-80-200	30	60	70	90	120	200	--	--	--	--
28	SLB-125-100	--	--	--	--	--	--	100	--	--	--
29	SLB-125-200	19	38	44	57	76	128	200	--	--	--
30	SLB-125-300	29	57	67	86	115	192	300	--	--	--
31	SLB-125-400	38	76	89	115	153	256	400	--	--	--
32	SLB-125-500	--	96	112	144	192	320	500	--	--	--
33	SLB-125/240-100	9.6	19	22	29	38	64	100	100	--	--
34	SLB-125/240-150	14	30	33.4	43	60	96	150	150	--	--
35	SLB-240-150	8	15	17.5	23	30	50	78	150	--	--
36	SLB-240-200	10	20	23	30	40	66	104	200	--	--
37	SLB-380-50	--	--	--	--	--	--	--	--	50	--
38	SLB-380-100	--	--	--	--	--	--	--	--	100	--
39	LB-480-100	2.5	5	5.8	7.5	10	16.6	26	50	79	100