

G4K Fixed Power Quality Analyzer

BLACKBOX

USER & INSTALLATION

GUIDE



The logo for ELSPEC, featuring a stylized 'E' and 'S' in a white, bold font, followed by 'PEC' in a similar font. A white swoosh is positioned above the 'E' and 'S'.

Date: October 2013

Document Version: V1.2

SMX-0602-0100

Find Quality Products Online at:

www.GlobalTestSupply.com

sales@GlobalTestSupply.com

Table of Contents

G4K Power Quality Analyzer - System Overview	6
Warranty	8
Acronyms	10
Product Selection Guide	13
Preparation - Safety Precautions	16
What You'll Need	18
Unpacking Components & Accessories	19
The G4K BLACKBOX Unit	23
G4K Quick & Simple Installation	25
G4K BLACKBOX Unit Mounting	25
G4K Wiring	28
Voltage Connections	32
Wiring the Current Connections	34
Connect the AC/DC Supply Terminal	36
Connect the 48VDC Input	38
Establish 1st Time Connection	39
Confirm Operation	41
G4K Unit Access	43
G4K Quick Configuration	46
G4K Unit Setup	47
Voltage & Frequency Configurations	49
Currents	51
Verify Measurement Readings	54
Access the Measurement Summary	55
Verify Voltage & Current Readings	57
Verify Power Readings	59
Enable PQZIP Recording	61
Monitoring Real-Time Data	63
Voltage & Current Measurements	66
Averaging	72
Power	76
Temperature	80

Phasors	82
Waveforms	87
Voltage Flickering.....	93
Pinst Waveform.....	96
Minimum / Maximum Flickering.....	98
Voltage & Current Harmonics	101
P & Q Harmonics	107
Spectrum	113
Harmonics Table	118
Voltage & Current, Min & Max Harmonics Table	121
PQ Min & Maximum Harmonics	124
About Power Quality Monitoring.....	127
PQ Compliance Summary	128
Compliance Information	132
Compliance Chart	135
Events.....	138
PQZIP Recording - Principle	140
Default Settings	142
PQZIP Recording - Configuration.....	143
Enabling / Disabling PQZIP	147
FIFO	149
Fixed Quality vs. Fixed Ratio	150
File Capacity	153
FFT Mode	155
Erase All PQZIP Data	157
About Energy	159
Consumption & Demand.....	160
Detailed Information	162
Measurement Status	164
About Instrument Settings.....	167
Device Setup.....	168
Device - Info G4K Unit Configuration	171
G4K Product Attributes	173
Power Status	174

PoE Output	175
Alarms	176
Voltage & Frequency.....	177
Power Configuration	179
Potential Transformer	181
Smooth Filtering	182
Voltage Polarity	183
Define Nominal Values	184
Time Settings	186
Network Time	188
Time Setup	189
Daylight Saving	190
Currents.....	191
Current Transformer.....	193
Nominal.....	194
Current Polarity.....	195
Non-Measured Currents.....	196
Communication Configuration	198
Security.....	199
About Network Setup.....	202
LAN 1	204
LAN 2 / LCD Port Setup.....	206
Port Setup.....	208
Outer Access	210
Modbus TCP	211
DNP3 Configuration.....	212
Status Summaries	213
Serial Ports	215
RS-485 / RS-422	217
PPP Configuration	219
PPP Status.....	220
Modem Configuration	221
About Power Quality Compliance	222
Power Quality Compliance Configuration	223
User Defined Pages	225

User Defined Page 1.....	227
User Defined Page 2.....	232
User Defined Page 3.....	236
Advanced Settings	239
System Log	241
Creating Custom Events.....	244
Events List.....	249
Create Event Conditions.....	251
Single Type Conditions	253
Multiple Type Conditions	256
E-Mail Alerts	258
Reports	262
Energy Mode.....	264
Parameter Mode	265
Energy Meter.....	266
Display Setup	269
Upgrade G4K Software - Firmware Upgrade	272
Upgrade the FW Using FTP.....	275
Local FW Upgrade	277
Optional Installations & Disconnections	279
Attach The PT100 Temperature Connection	279
Connect Power Over Ethernet	280
Detach the Voltage Terminal Block Connector	281
About Elspec's Search Utility	282
Obtain Elspec's Search Utility	283
Use the Elspec's Search Utility	284
G4K Unit Access	287
New Device Indication.....	291
Limitations of Elspec's Search Utility.....	292
G4K Specifications.....	293
G4K Physical Specifications.....	299

G4K Power Quality Analyzer - System Overview

The innovative design of the G4 400 BLACKBOX device series is a technological breakthrough providing the Perfect Permanent PQ Analysis solution. Its enhanced capabilities are uniquely adaptable to address the individual needs & requirements for almost any business and/or application. Empowered by the patented PQZIP compression technology, the G4K can store up to a thousand times more than other typical file formats. The PQZIP allows the G4K to continuously record & store all electrical waveforms for extended periods with no gaps in the data. Its superior accuracy yields a 2 x 16 Bit to yield, far surpassing IEC61000-4-30 Class A requirements. The G4K features a threshold-free setup, & is equipped with standard industrial protocols for seamless integration into any SCADA system. It provides PQ parameters according to EN50160, IEC61000-4-30, & other national standards, and the data may be analyzed over any network at any remote location.

The advanced POSCADA & Investigator Enterprise Analysis software enables the operator to detect, view, control, analyze & isolate the minutest PQ anomaly for the diagnosis & effective maintenance of equipment. It simplifies troubleshooting & time-synchronized data recorded by any number of BLACKBOX devices, can be compared within a particular site and/or across many sites.

The embedded Website serves as the main user-interface with the unit, providing enhanced management, unit configuration & real-time monitoring of all parameters.

The optional G4100 Remote Display LCD Unit (RDU) is an integral part of the Elspec Power Quality Data Center system, allowing inter-connectivity with the G4400 series instruments for configuring and monitoring the electrical distribution system. The G4100 connects and communicates with the G4400 BLACKBOX devices directly via RJ45 network cable or through IP communication from anywhere in the world. One RDU can be used to monitor and configure many G4400 series instruments.

The figure below provides a graphical outline of the G4K System:



SEE ALSO

- [Acronyms](#)
- [G4K Warranty](#)
- [Product Selection Guide](#)

Warranty

Each Elspec product is under warranty to be free from defects in material and workmanship under normal use and service. The warranty period is for one year and commences on the date of shipment. Parts, product repairs, and services are under warranty for 90 days. This warranty extends only to the original buyer or end-user customer and it does not apply to fuses, disposable batteries, or to any product which, in Elspec's opinion, has been misused, altered, neglected, contaminated, or damaged by accident or abnormal conditions in the operation or handling of the product. Elspec warrants that the software will operate substantially in accordance with its functional specifications for 90 days and that it has been properly recorded on non-defective media. Elspec does not warrant that the software will be error free and operate without interruption.

Elspec authorized re-sellers shall extend this warranty on new and unused products to end-user customers only, but do not have authority to extend a greater or different warranty on behalf of Elspec. Warranty support is available only if the product is purchased through an Elspec authorized sales outlet or Buyer has paid the applicable international price. Elspec reserves the right to invoice the Buyer for any importation costs for the repair/replacement of parts when the product purchased in one country is submitted for repair in another country.

Elspec's warranty obligation is limited, at Elspec's option, to refund of the purchase price, free of charge repair, or replacement of a defective product which is returned to Elspec within the warranty period. For warranty service, contact Elspec directly to obtain a return-authorization. On receipt of the authorization, return the product to Elspec with a description of the problem, including prepaid postage and insurance (FOB destination). Elspec assumes no risk for damage in transit. Following warranty repair, the product will be returned to the Buyer, transportation prepaid (FOB destination). If Elspec determines that the failure was caused by neglect, misuse, contamination, alteration, accident, or abnormal condition of operation or handling, including overvoltage failures caused by use outside the product's specified rating, or normal wear and tear of mechanical components, Elspec will provide an estimate of repair costs and obtain authorization before commencing work. Following repair, the product will be returned to the Buyer, transportation prepaid, and the Buyer will be billed for the repair and return postage transportation charges (FOB Shipping Point).

This warranty is the Buyer's sole and exclusive remedy and is in lieu of all other warranties, express or implied, including but not limited to any implied warranty of merchantability or fitness for a particular purpose. Elspec shall not be liable for any special, indirect, incidental, or consequential damages or losses, including loss of data arising from any cause or theory.

Since some countries or states do not allow limitation of the term of an implied warranty, or exclusion or limitation of incidental or consequential damages, the limitations and exclusions of this warranty may not apply to every buyer. If any

decision-maker of competent jurisdiction, such holding will not affect the validity or enforceability of any other provision.

NOTICE REGARDING PROPRIETARY RIGHTS

This publication contains information proprietary to Elspec. By accepting & using this manual, you agree that the information contained herein will be used solely for the purpose of operating equipment developed & manufactured by Elspec.

SEE ALSO

- [System Overview](#)
- [Acronyms](#)
- [Product Selection Guide](#)

Acronyms

The following acronyms are being used within this document:

ACRONYM	DEFINITION
PQ	Power Quality
V	Voltage
F	Frequency
V _N	Voltage Neutral
A	Ampere
CT	Current Transformer
PF	Power Factor
PT100	Platinum Resistance Thermometers
PU	Per Unit
PT	Potential Transformer (transformation ratio in both magnitude and phase)
CT	Current Transformer
THD	Total Harmonic Distortion
HV	High Voltage
MV	Medium Voltage
LV	Low Voltage
ADC	Analog to Digital Converter
SSL	Secure Sockets Layer
GPS	Global Positioning System
UTC	Coordinated Universal Time
LAN	Local Area Network
CF	Compact Flash

ACRONYM	DEFINITION
OLP	OLE for P rocess C ontrol (set o f connectivity s tandards f or industrial automation)
OPC	Open Connectivity (formerly OLE for Process Control)
TCP	Transport Control Protocol
FTP	File Transfer Protocol
DHCP	Dynamic Host Configuration Protocol
DNP3	Distributed Network Protocol
PPP	Point to Point Protocol
PAP	Password Authentication Protocol
CHAP	Challenge Handshake Authentication Protocol
UART	Universal Asynchronous Receiver Transmitter
ISP	Internet Service Provider
INIT	Initialization (INIT String used in Modem)
AT	A command string should start with "AT" or "at", except for the commands "A/" and "+++". At or aT are invalid
PST	Value measured over x period that characterizes the likelihood that the voltage fluctuations would result in perceptible light flicker
THD	Total Harmonic Distortion
TDD	Total Demand Distortion
Ampl	Amplitude
FIFO	First In First Out
FFT	Fast Fourier Transform
csv	Comma Separated Values

ACRONYM	DEFINITION
ELSPEC G4400 BLACKBOX DEVICE & ACCESSORIES	
G4K	G4400 BLACKBOX Series of Power Quality Analyzers
PQZIP	Power Quality Data Compression & Archive File Format
PQSCADA	Power Quality Supervisory Control and Data Acquisition
RDU	G4100 Remote Display LCD Unit
CPU	G4K - Central Processing Unit Module
DSP	G4K - Digital Signal Processing Module
PS	G4K - Power Supply Module
FW	Firmware - G4K Software

SEE ALSO

- [System Overview](#)
- [G4K Warranty](#)
- [Product Selection Guide](#)

Product Selection Guide

The product selection guide will assist you in choosing the optimal G4K Power Quality Analyzer that will suit your needs & requirements. The BLACKBOX device series includes 3 products, namely the G4410, G4420 & G4430. They are mainly differentiated by their measurement capabilities, storage capacity, PQ analysis & communication ports.

CAPABILITIES	PRODUCT SERIES		
	G4410	G4420	G4430
REAL-TIME MEASUREMENTS			
Voltage Sampling Rate, Maximum Samples/Cycle	256	512	1024
Voltage/Current - Per Phase, Average, Unbalanced	√	√	√
Power: Real, Reactive, Apparent, Power Factor, Frequency	√	√	√
Energy: Bidirectional, Total, Import, Export, Net	√	√	√
Demand: Block	√	√	√
Voltage Harmonics (Individual, Even, Odd, Total) Up to-	127 TH	255 TH	511 TH
Type of Analog to Digital Converter	16/20 ¹ Bit	16/20 ¹ Bit	16/20 ¹ Bit
Measurement During Overloading (From Nominal)	x2	x10	x10

CAPABILITIES	PRODUCT SERIES		
	G4410	G4420	G4430
DATA & WAVEFORMS LOGS			
Cycle-By-Cycle PQZIP Recording	√	√	√
Event Logs	√	√	√
Continuous Waveform Recording	√	√	√
Min/Max Logs For Any Parameter	√	√	√
TIME STAMPS, RESOLUTION (MICROSECONDS)			
With Ethernet Synchronization	50	50	50
With GPS Synchronization	1	1	1
STORAGE CAPACITY			
Internal Memory	128 MB	4 GB	16 GB
POWER QUALITY ANALYSIS			
Transient Detection, Microseconds (50Hz/60Hz)	78.1/65.1μs	39/32.5μs	19.5/16.3μs
Sag/Swell Monitoring	√	√	√
Unbalance Components: Zero, Negative, Positive	√	√	√
Flicker (IEC 61000-4-15)	√	√	√
Fast Flickering	√	√	√
Compliance Testing To EN50160	√	√	√
EN50160 Timestamps	√	√	√
Configurable for IEEE519-1992, IEEE159 (SEMI)	√	√	√
Time Stamps Of Above	—	√	√
Internal Harmonics	√	√	√

CAPABILITIES	PRODUCT SERIES		
	G4410	G4420	G4430
COMMUNICATION PORTS			
OPC	√	√	√
Power Over Ethernet (PoE) - In	√	√	√
Power Over Ethernet (PoE) - Out	—	√	√
Ethernet Ports	1	2	2
COMMUNICATION PORTS - CONTINUE			
RS-485/422 Port	√	√	√
Voltage Ride Through on Power Loss (Up to)	10 sec.	25 sec.	25 sec.
USB Port (Power Only)	—	√	√
Onboard Comprehensive Web Server	√	√	√
DNP3	√	√	√
Modbus TCP	√	√	√
E-MAIL NOTIFICATIONS			
SMTP Client	√	√	√
¹ Effective Bits	Disclaimer: Outlined capabilities subject to change without prior notice		

SEE ALSO

- [System Overview](#)
- [Acronyms](#)
- [G4K Warranty](#)

Preparation - Safety Precautions

WARNINGS

REVIEW THE ENTIRE MANUAL BEFORE USING THE INSTRUMENT AND ITS ACCESSORIES

OBSERVE ALL WARNINGS AND CAUTIONS

DO NOT OPERATE THE INSTRUMENT AROUND EXPLOSIVE GAS OR VAPOR

AVOID WORKING ALONE

BEFORE USE, INSPECT THE INSTRUMENT, LEADS AND ACCESSORIES FOR MECHANICAL DAMAGE, AND REPLACE WHEN DAMAGED

PAY SPECIAL ATTENTION TO THE INSULATION SURROUNDING THE CONNECTORS AND PLUGS

REMOVE ALL ACCESSORIES THAT ARE NOT IN USE

MAKE SURE THE INSTRUMENT IS PROPERLY GROUNDED TO A PROTECTIVE EARTH GROUND

DO NOT APPLY INPUT VOLTAGES ABOVE THE RATING OF THE INSTRUMENT AS SHOWN ON THE NAME PLATE

DO NOT INSERT METAL OBJECTS INTO CONNECTORS AND OPENINGS

NEVER OPEN THE INSTRUMENT'S ENCLOSURE DURING OPERATION; DANGEROUS VOLTAGES ARE PRESENT

USE THE INSTRUMENT ONLY AS SPECIFIED IN THIS MANUAL, OR THE PROTECTION PROVIDED BY THE INSTRUMENT MAY BE IMPAIRED

DO NOT EXPOSE THE INSTRUMENT TO EXTREME MOISTURE AND OR RAIN

TO AVOID SHOCK OR FIRE

VERIFY THAT THE UNIT IS DISCONNECTED FROM THE MAIN POWER SUPPLY

INSPECT ALL ELECTRICAL AND MECHANICAL CONNECTIONS VISUALLY FOR MECHANICAL DAMAGE AND INTEGRITY OF COMPONENTS AND ACCESSORIES

INSPECT CURRENT TRANSFORMER WIRING FOR PROPER DIRECTION THROUGH THE CYLINDRICAL APERTURE OF THE CURRENT SAMPLING MODULE

PULL-TEST ALL CONTROL WIRING TO ENSURE SECURE SEATING IN TERMINALS

BEFORE USE, INSPECT THE INSTRUMENT, LEADS AND ACCESSORIES FOR MECHANICAL DAMAGE, AND REPLACE WHEN DAMAGED

DO NOT OPERATE THE INSTRUMENT OR ITS ACCESSORIES IF IT BECAME WET FOR ANY REASON

SEE ALSO

- [System Overview](#)
- [What You'll Need](#)
- [Unpacking Components & Accessories](#)
- [G4K BLACKBOX Unit](#)
- [G4K BLACKBOX Unit Mounting](#)

What You'll Need

Familiarize yourself with the [G4K BLACKBOX Unit, Components & Accessories](#). In addition, ensure that you follow the outlined [Safety Precautions](#). You will need the following tools & additional items for the initial installation:

- Wire Strippers
- Phillips Screwdriver
- Flat Head Screwdriver
- G4K BLACKBOX Unit, Components & Accessories
- This User Guide

SEE ALSO

- [System Overview](#)
- [Preparation - Safety Precautions](#)
- [Unpacking Components & Accessories](#)
- [G4K BLACKBOX Unit](#)

Unpacking Components & Accessories

The G4K BLACKBOX is shipped from Elspec's factory in a sealed case to protect it from damage during transportation. The small parts are shipped in a sealed bag with the unit.





TO UNPACK THE UNIT & ITS ACCESSORIES

Remove the unit & all of the following components from the casing:

QUANTITY	ILLUSTRATION	DESCRIPTION & PART NUMBER
DEVICE, COMPONENTS & ACCESSORIES		
1		<p>G4K BLACKBOX Device</p> <ul style="list-style-type: none"> G4410 BLACKBOX: SPG-4410-0000 G4420 BLACKBOX: SPG-4420-0000 G4430 BLACKBOX: SPG-4430-0000
SEE ALSO		
		<ul style="list-style-type: none"> Product Selection Guide
1		<p>Voltage Terminal Block Connector (For Sampling)</p> <ul style="list-style-type: none"> ENT-1005-0090
1		<p>AC/DC Terminal Block Connector (For Powering the Unit)</p> <ul style="list-style-type: none"> ENT-1003-0192
1		<p>RS485/422 Communication Terminal Block (For Communication)</p> <ul style="list-style-type: none"> ENT-1004-0190

QUANTITY	ILLUSTRATION	DESCRIPTION & PART NUMBER
1		48VDC Terminal Block Connector (For Powering the Unit) <ul style="list-style-type: none"> ▪ ENT-1002-0190
1		Temperature Sensor Terminal Block Connector (For PT100 Type) <ul style="list-style-type: none"> ▪ ENT-1003-0190
1		Clamping Yoke Holder on Rail 35mm FM 4 <ul style="list-style-type: none"> ▪ MAL-2000-5002
1		Installation & Demonstration Disc <ul style="list-style-type: none"> ▪ SMX-0408-0100

Orders for optional accessories will be delivered as well in a sealed casing. Unpack these parts from their sealed bags:

QUANTITY	ILLUSTRATION	DESCRIPTION & PART NUMBER
OPTIONAL ACCESSORIES		
As Ordered		<p>BLACKBOX Full User Guide SMX-0602-0100</p>
As Ordered		<p>G4100 Remote Display LCD Unit (Provide G 4K I nter-Connectivity f or C onfiguring & M onitoring the El ectrical Distribution System)</p> <ul style="list-style-type: none"> ▪ SPG-4100-0090
As Ordered		<p>GPS (Global Position System) (For M obile T ime Synchronization)</p> <ul style="list-style-type: none"> ▪ SOA-0232-0400
As Ordered		<p>Multi-Frequency 3.5G Wireless Modem (For Fa st Mobile Communication Access)</p> <ul style="list-style-type: none"> ▪ SCM-0001-0000
As Ordered		<p>G4400 Multi IO Expansion (For M onitoring C apabilities Extension - Additional Digital & Analog IO Ports)</p> <ul style="list-style-type: none"> ▪ G4430 + 1 Multi IO Module: SPG-4431-0090 ▪ G4430 + 2 Multi IO Modules: SPG-4432-0090 ▪ G4420 + 1 Multi IO Module: SPG-4421-0090 ▪ G4420 + 2 Multi IO Modules: SPG-4422-0090 ▪ G4410 + 1 Multi IO Module: SPG-4411-0090 ▪ G4410 + 2 Multi IO Modules: SPG-4412-0090

QUANTITY	ILLUSTRATION	DESCRIPTION & PART NUMBER
OPTIONAL ACCESSORIES		
As Ordered		Protective Metal Cabinet (IP54) with wiring (H x W x D) - 50 x 50 x 30cm (19.7 x 19.7 x 11.8") : ▪ SOA-0002-0000
As Ordered		Polycarbonate Enclosure (IP54) with wiring (H x W x D) - 50 x 50 x 30cm (19.7 x 19.7 x 11.8") : ▪ SOA-0003-0000
As Ordered		200W Heater with Thermostat: ▪ SOA-0101-0000
As Ordered		RJ45/Fiber Optic Converter: ▪ SOC-0401-0000

SEE ALSO

- [System Overview](#)
- [Preparation - Safety Precautions](#)
- [What You'll Need](#)
- [G4K BLACKBOX Unit](#)

The G4K BLACKBOX Unit

The innovative design of the G4K BLACKBOX has been uniquely adapted to address the individual needs & requirements for almost any business and/or application. The modular & expandable design provides maximum flexibility for customized requirements.

The main base (front end) of the unit is comprised of three modules namely the Central Processing Unit (CPU), the Digital Signal Processing (DSP), & the Power Supply (PS).

The functions for the CPU are mainly data compression, file handling & facilitation of communication interfaces. The CPU features an AC/DC power supply, DC/DC converter, an automatic selection of highest voltage & an ultra capacitors' ride-through for up to 25 seconds.

The DSP is responsible for capturing the electric signal & converting the waveforms to digital data. The DSP's capabilities include simultaneous 12 channel sampling at 250 kHz (4 μ sec), full scale measurements 10 x from nominal voltages & currents at an extremely high accuracy. The CT's dual range with auto selection ranges from 0 - 5A, 0 - 50A RMS & has a reading accuracy of 0.1%. There are a total of six (6) apertures. Typically only the first four (4) are used as current inputs for I1, I2, I3, and IN (Neutral current optional as the fourth input).

The PS facilitates a wide range of inputs that comply with the highest standards set by the industry. The power supply module contains internal backup circuitry to hold internal voltage during momentary transients and disturbances. Thus, when powering off the unit, it continues operating for up to 1 minute. The power supply supports the following power sources:

- DC 100-300V
- AC 100-260V, 60/50 Hz (recommended)
- PoE 48V

The top of this front end base facilitates the connection for the PT100 thermostat & the DC Converter input. In addition to the PT100 connection, the G4K is equipped with 2 additional internal temperature sensors (PS and DSP modules). The operating temperature ranges from -20 to +70°C & the storage temperature ranges from -30 to +80°C. The DC Converter ranges from an input DC of 48 VDC & a minimum voltage for PoE of 48 VDC.

Physical layout of the 3 modules including the location of the system connectors for both the Front & Top View:

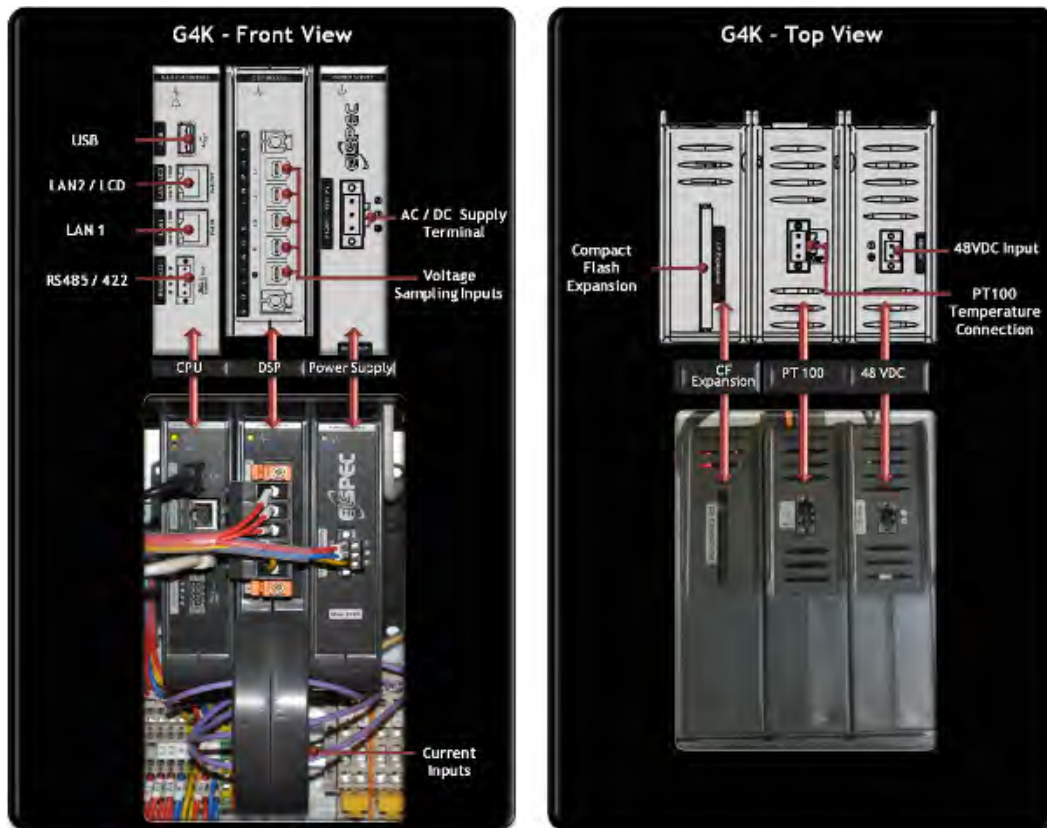

SEE ALSO

- [System Overview](#)
- [Preparation - Safety Precautions](#)
- [What You'll Need](#)
- [Unpacking Components & Accessories](#)

G4K Quick & Simple Installation

This section contains the installation & setup procedure for the G4K BLACKBOX that is quick & simple to follow. After you have installed your G4K device, you can:

- Monitor the Quality of your Electrical Power,
- Monitor PQ Parameters according to EN50160, IEC61000-4-30 & Customized Standards
- Store a thousand times more than other typical file formats with PQZIP

G4K - QUICK & SIMPLE INSTALLATION

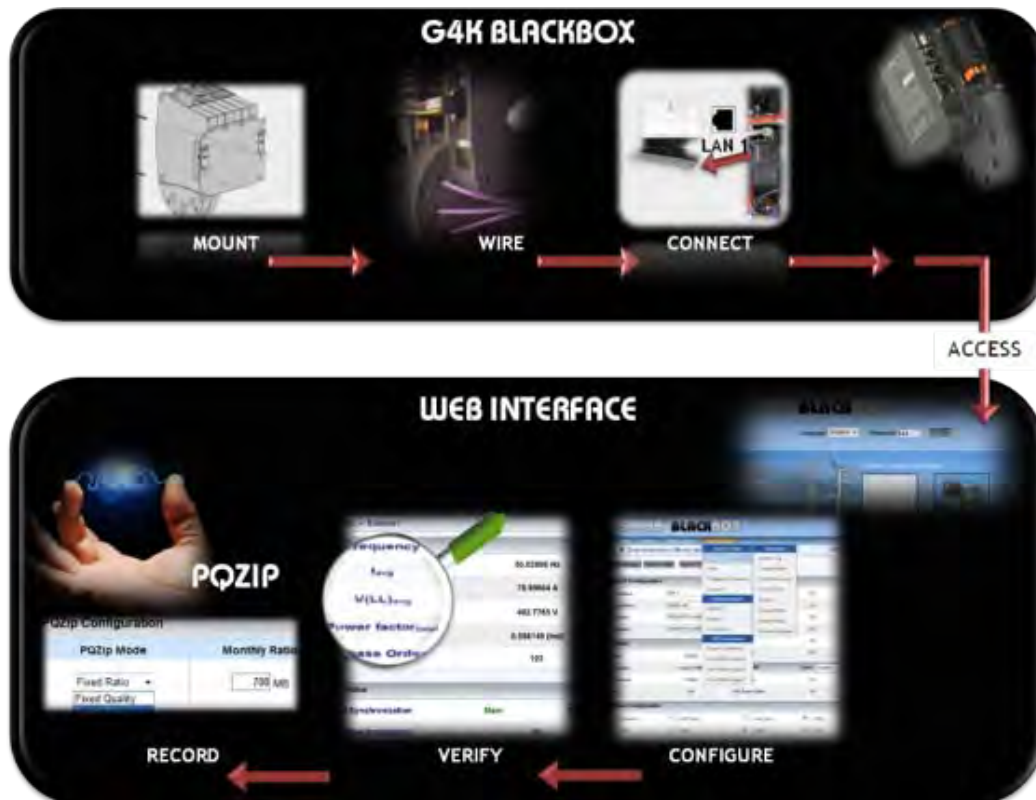

The procedure includes:

- [Mounting the G4K BLACKBOX](#)
- [Wiring the G4K BLACKBOX](#)
- [Connecting the G4K BLACKBOX](#)
- [Confirming the G4K's Operation](#)
- [G4K Unit Access via Elspec's Web Interface](#)
- [Configuring the G4K Device](#)
- [Verifying Measurement Readings](#)
- [Enabling PQZIP Recording](#)

! WARNING

Before you start, ensure that the panel is de-energized & that you take the necessary [Safety Precautions](#)!

The G4K BLACKBOX is intended to be mounted within an enclosure, or can be fastened either to a DIN Rail or to a Flat Surface. The physical dimensions of the G4K are: 17.5 x 23.2 x 13.8cm (6.9 x 9.1 x 5.4”) & it weighs 1.7Kg (3.7lbs).

FASTENING THE G4K BLACKBOX TO A DIN RAIL

This is the most common mounting method & you will need the Clamping Yoke Holders provided with G4K & the unit itself - see [Components & Accessories](#).

- Connect the Clamping Yoke Holders to the sides of the back plate of the G4K using the 2 screws provided,
- Attach the entire unit with the holders to the DIN Rail:

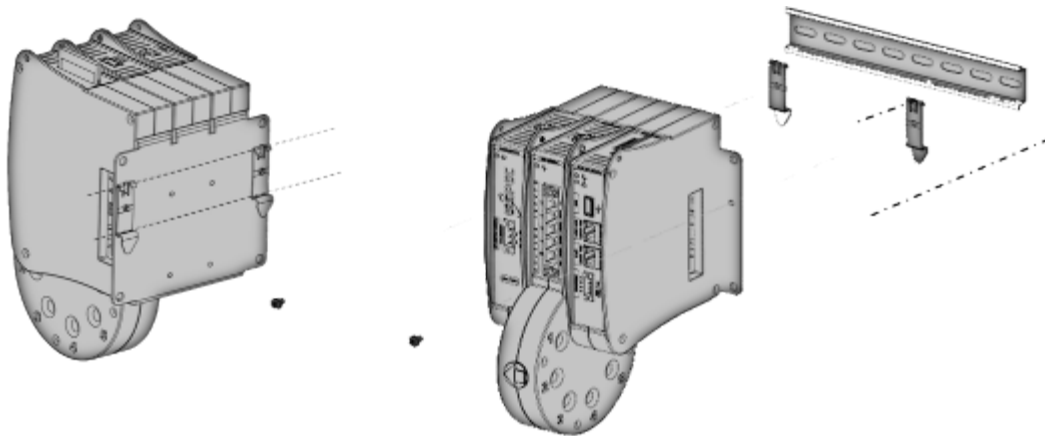

FASTENING THE G4K BLACKBOX TO A PLATE

The G4K BLACKBOX can be directly mounted to a plate using 4 x standard 7mm (0.27”) screws.

- The distance of the screws on the G4K plate is (H x W) 10 x 12cm (3.9 x 4.7”). Ensure the plate has corresponding holes,
- Simply screw the G4K unit onto the plate at the corresponding holes:

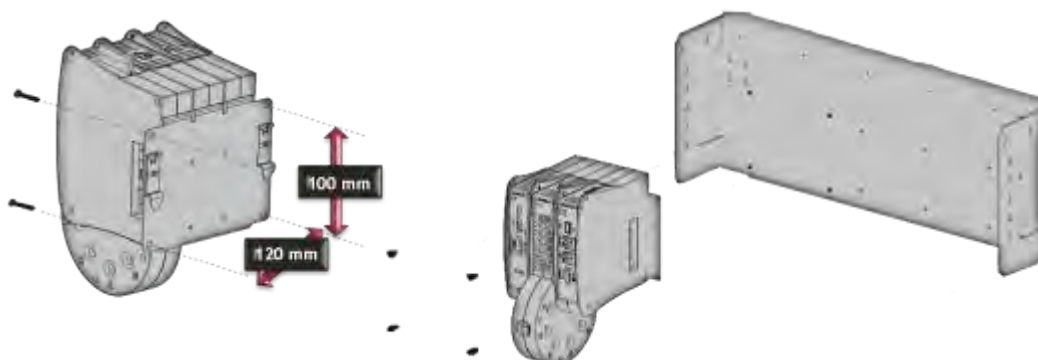

Successfully Mounted G4K Unit



SEE ALSO

- [Installation](#)
- [G4K Wiring BLACKBOX](#)
- [Establish 1st Time Connection](#)
- [Confirm Operation](#)
- [G4K Unit Access](#)
- [G4K Configuration](#)
- [Verifying Measurement Readings](#)
- [Enable PQZIP Recording](#)

G4K Wiring

The [DSP Module of the G4K](#) receives analog signals and converts them to digital signals to be measured and stored for further processing and analysis. An essential part of the G4K Wiring Procedure is the [Power Configuration](#), which is configured in the Web Interface. Included in this section are the types of Power Topology the G4K supports that will be important to understand prior to proceeding with:

- [Connecting the Voltage Connections](#)
- [Connecting the Current Connections](#)
- [Connecting the AC/DC Supply Terminal](#)
- [Connecting the 48 VDC Input](#)

G4K BLACKBOX POWER TOPOLOGY SUPPORTS

The G4K BLACKBOX is designed to serve virtually any power topology configuration. The diagrams below outline the types of topologies with their applicable Configuration in Elspec's Web Interface:

- [Single LN Configuration:](#)

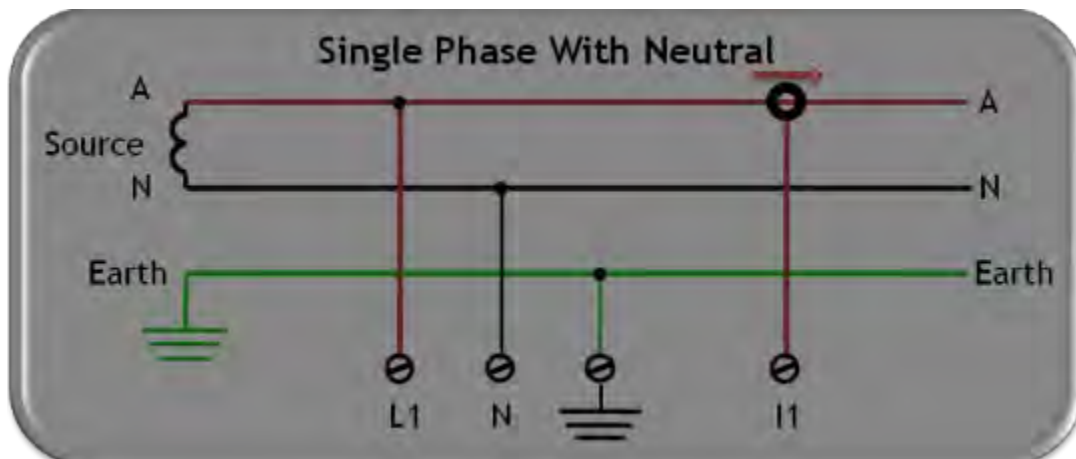

- [Single LL Configuration:](#)

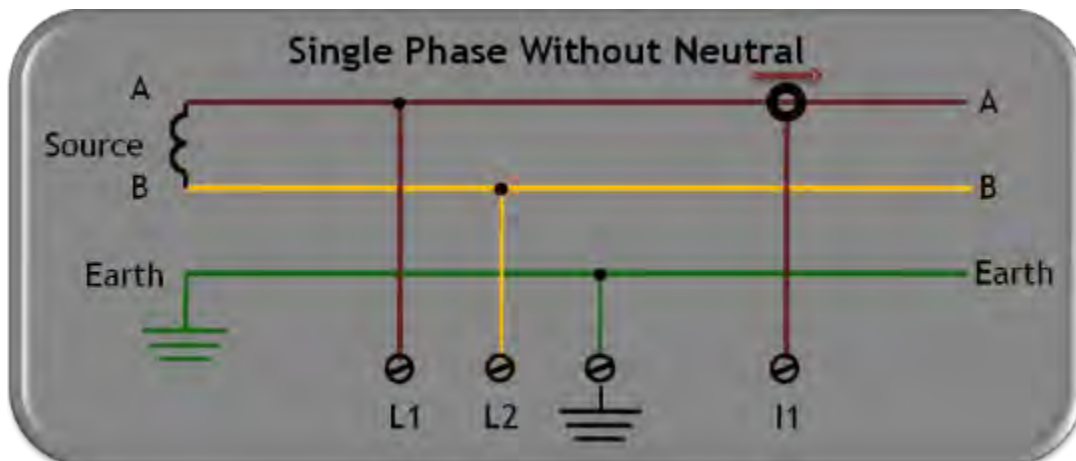

- [2Phase TR:](#)

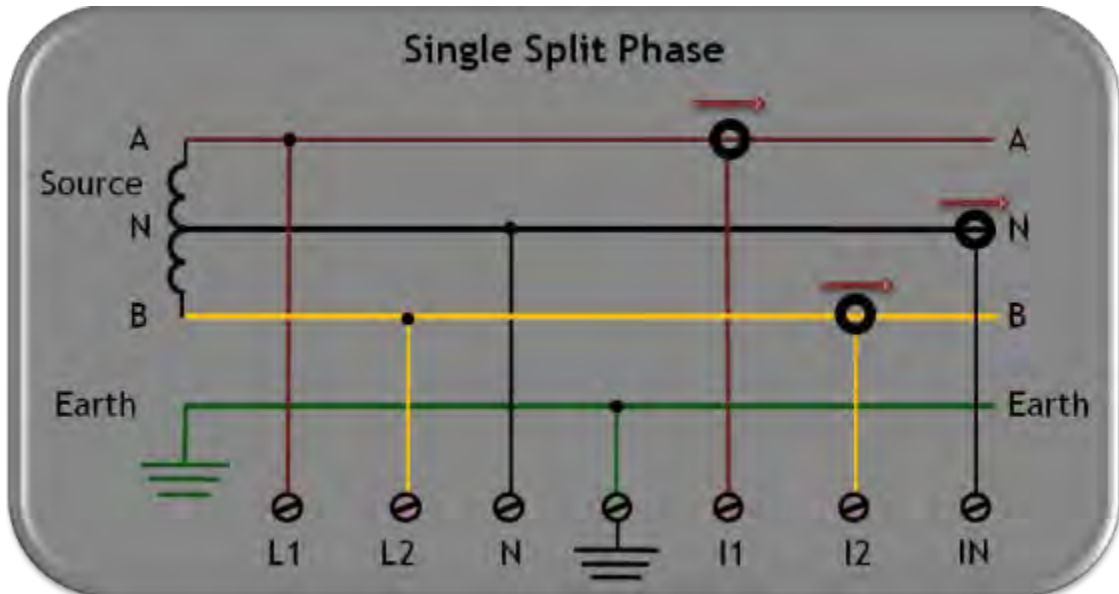

- [Delta 3 Wires:](#)



- [WYE 4 Wires:](#)

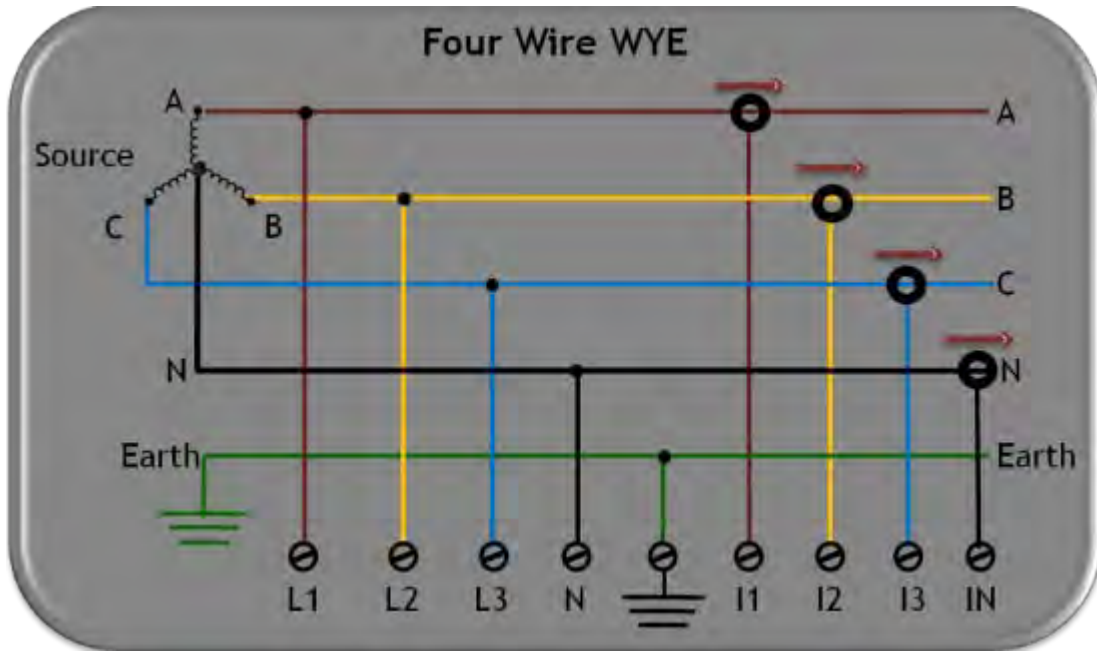

- [WYE 4 Wires:](#)

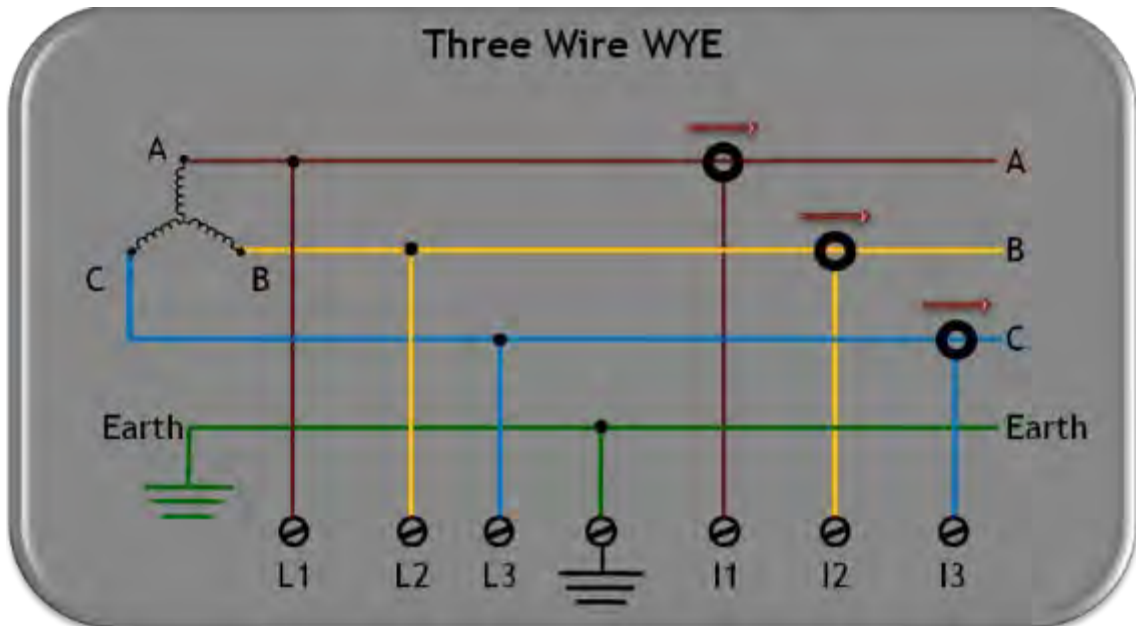

- [Delta 3 Wires:](#)

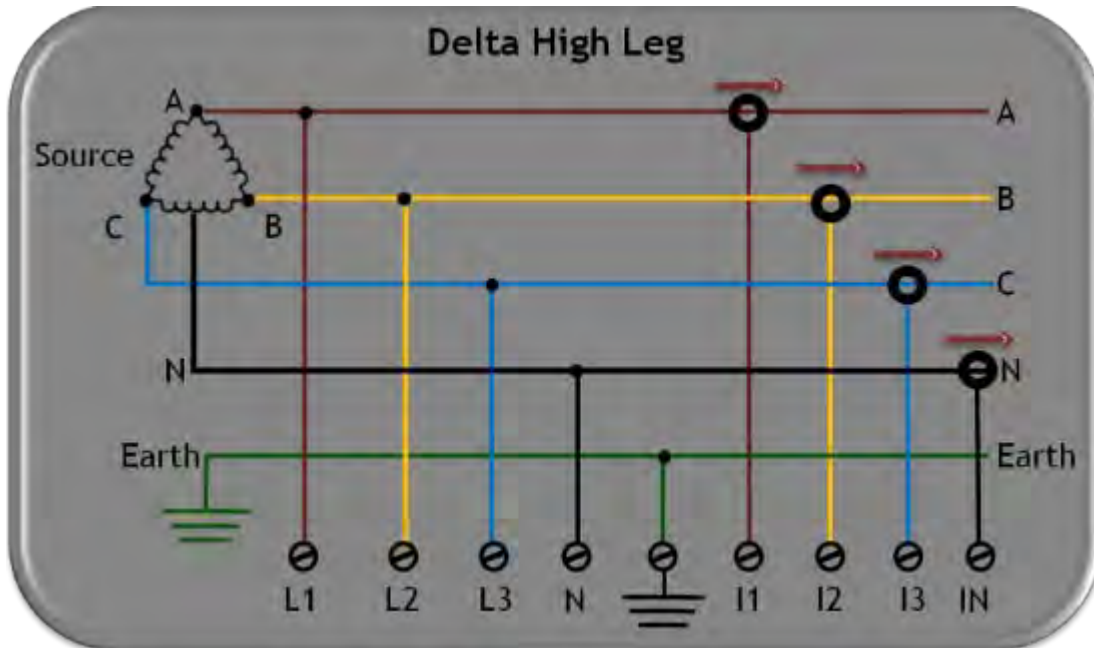

- [Delta 3 Wires:](#)

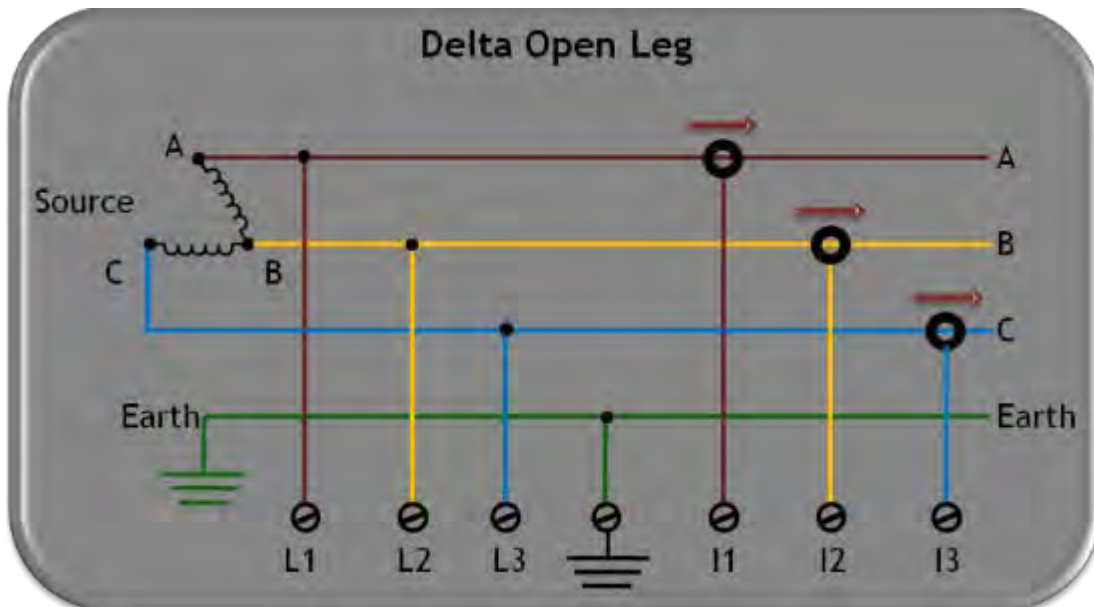

SEE ALSO

- [Installation](#)
- [G4K Unit Mounting BLACKBOX](#)
- [Establish 1st Time Connection](#)
- [Confirm Operation](#)
- [G4K Unit Access](#)
- [G4K Configuration](#)
- [Verifying Measurement Readings](#)
- [Enable PQZIP Recording](#)

Voltage Connections

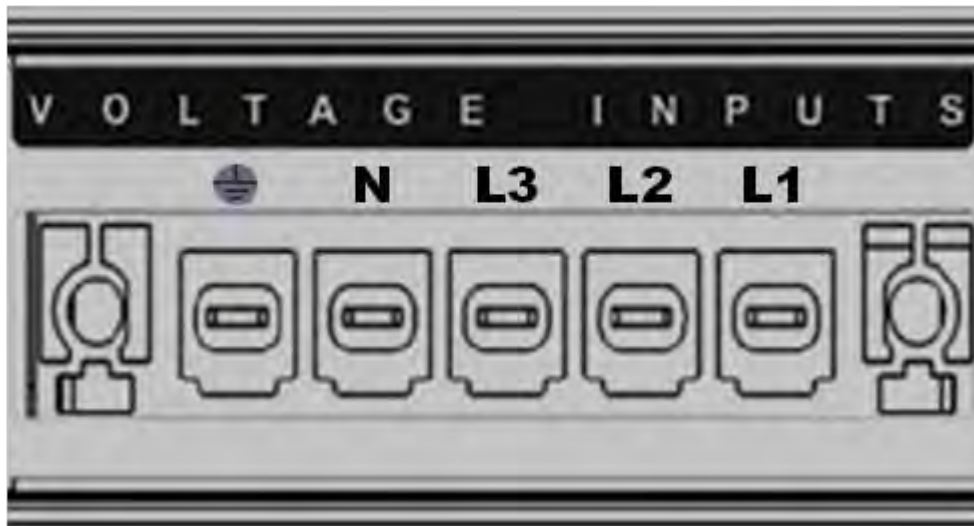

Five terminals are available for the voltage sampling inputs on the DSP Module of the G4K. They are marked as L1, L2, L3, N, & . Each of the 4 inputs (V1, V2, V3, N) are capable of receiving electrical signals of up to 1KV continuous RMS (up to 8KV transient). In order to wire voltage connections, follow the following procedure:

- Install an over current device on the AC phase lines:

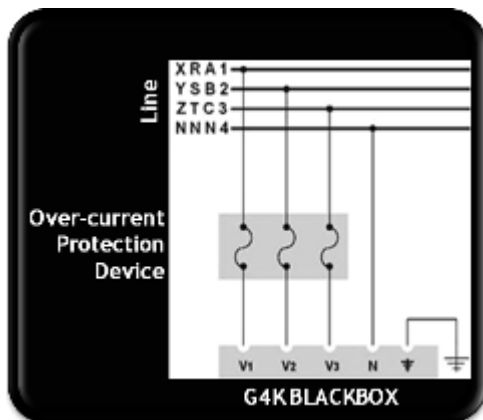

- Remove the [Voltage Terminal Block Connector](#) provided with the G4K Unit:



- Insert the terminal block into the Voltage Sampling inputs:

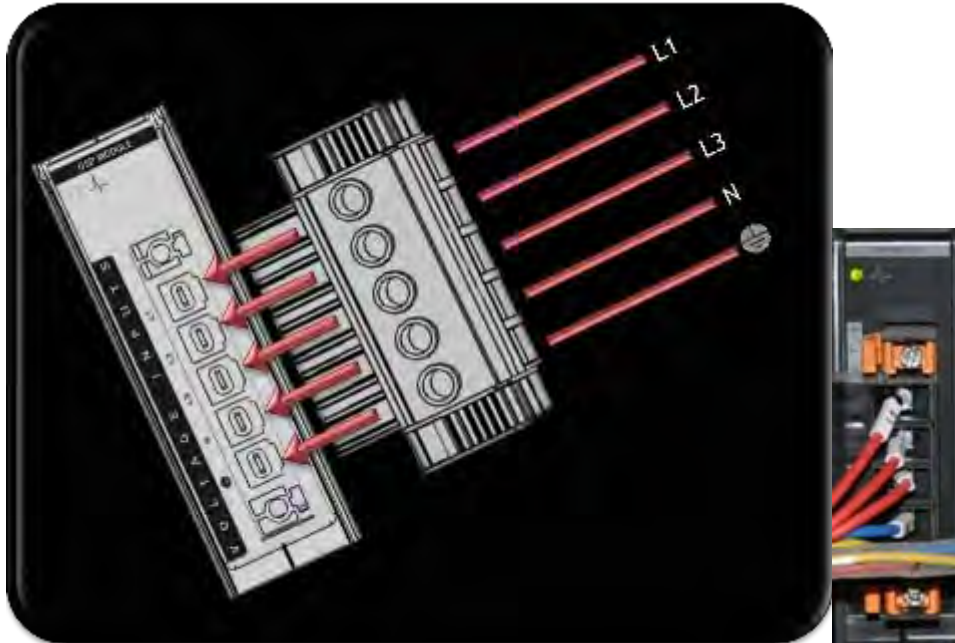

- Attach lugged ends of wires to the terminal block securing it with an applicable sized screw driver,
- Verify the correct voltage polarity of the terminal.

! WARNING

- *You need to install a 2A Fuse and/or Circuit Breaker in series to the instrument's Voltage Sampling Input Terminals according to local wiring codes.*
- *Powering down the instrument does not remove voltage from the voltage sampling terminals.*

NOTE NOTE NOTE ...

- The Ground input is the reference for all channels therefore it is essential to connect it properly.

SEE ALSO

- [G4K Wiring](#)
- [Wiring the Current Connections](#)
- [Connect the AC/DC Supply Terminal](#)
- [Connect the 48VDC Input](#)
- [Establish 1st Time Connection](#)

Wiring the Current Connections

Electric current is sampled as it flows through cylindrical apertures in the circular section of the centrally mounted Digital Signal Processing (DSP) Module. There are a total of six (6) apertures. Typically only the first four (4) are used as current inputs for I 1, I 2, I 3, and I N (Neutral current optional as the fourth input). Optionally, a fifth aperture may be ordered for an additional current input, and the sixth aperture is disabled at this stage. To wire current connections:

- Install Current Transformers in series ahead of the unit
- Feed the current lines through the cylindrical apertures in the circular section of the G4K's DSP Module:



- Verify the polarity of current conductors with the arrows on the circular section of the DSP



G4K Successful Current Wiring

! WARNING

Current Transformer outputs must be short circuited to prevent them from getting damaged. Dangerous voltages exist between the two output leads.

SEE ALSO

- [G4K Wiring](#)
- [Voltage Connections](#)
- [Connect the AC/DC Supply Terminal](#)
- [Connect the 48VDC Input](#)
- [Establish 1st Time Connection](#)

Connect the AC/DC Supply Terminal

The AC terminal may be fed with either AC or DC voltage. The procedure to wire both is the same and has the following limits:

- AC: 80 to 260V @ 50/60Hz
- DC: 110 to 300V / 35Watt

CONNECTING THE AC/DC SUPPLY TERMINAL:

- Install an Over-current Protection device on the AC phase line side before the unit:

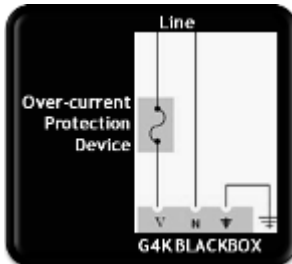

- Remove the [AC/DC Terminal Block Connector](#) provided with the G4K BLACKBOX unit:

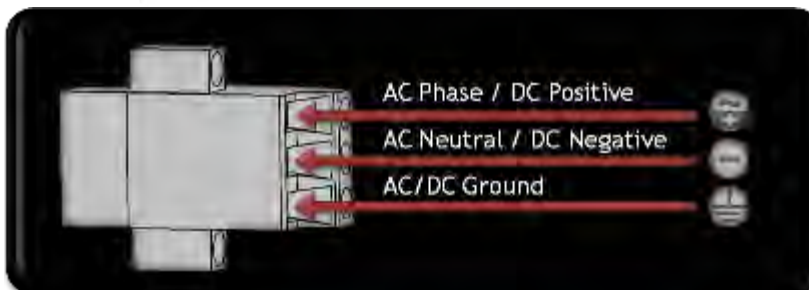

- Insert the terminal block into the Power Supply Terminal:

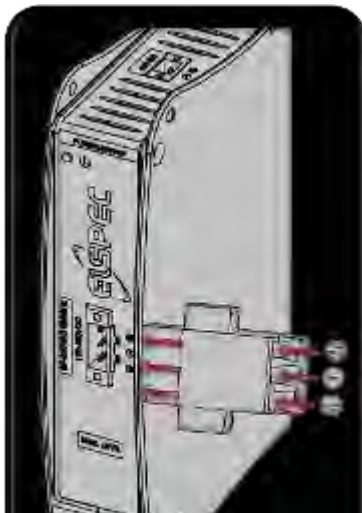

- Attach the bared ends of wires to the AC/DC terminal block connector using the correct sized flat-head screwdriver
- Verify the correct polarity of the terminal

WARNINGS

- *It is recommended to install a 2A fuse & or circuit breaker in series to the instrument terminals according to local wiring codes.*
- *When powering down the instrument by closing the circuit breaker, internal low voltage remains on the instrument terminals, and consequently on the downstream side of the circuit breaker for 25 seconds, due to the ride through back up feature.*

SEE ALSO

- [G4K Wiring](#)
- [Voltage Connections](#)
- [Wiring the Current Connections](#)
- [Connect the 48VDC Input](#)
- [Establish 1st Time Connection](#)

Connect the 48VDC Input

The two wire 48V DC voltage input is positioned on the upper side of power supply module. In order to energize the 48VDC terminal follow the procedure outlined below:

- Remove the [48VDC Terminal Block Connector](#) provided with the G4K BLACKBOX unit:

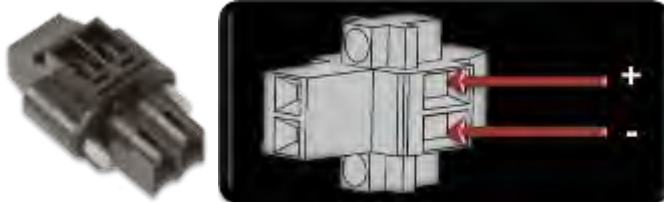

- Insert the 48V DC Terminal Block Connector into the Power Supply Module:

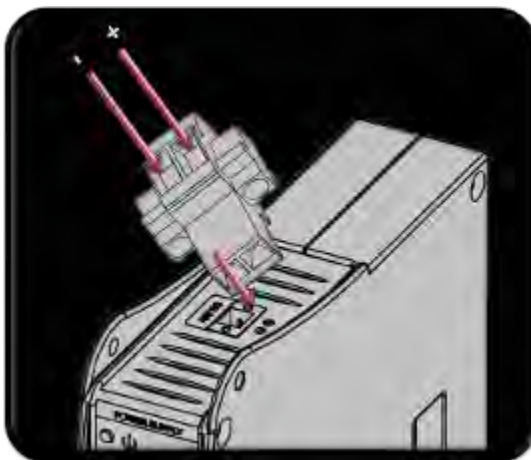

- Attach the lugged ends of wires to the Terminal Block using an applicable flat head screw driver
- Verify as to what the correct polarity is of the terminal

WARNING

When powering down the instrument by closing the circuit breaker, internal voltage remains on the downstream side of the circuit breaker for 25 seconds, due to the ride through back up feature.

SEE ALSO

- [G4K Wiring](#)
- [Voltage Connections](#)
- [Wiring the Current Connections](#)
- [Connect the AC/DC Supply Terminal](#)
- [Establish 1st Time Connection](#)

Establish 1st Time Connection

In order to establish communication between your G4K & the Network Server, the device may be connected using the LAN1 Port directly to an existing local LAN (if one exists). Alternatively, you may connect the device directly to the PC to establish initial communication.

CONNECT THE DEVICE TO THE LOCAL NETWORK

- Simply connect a RJ45 LAN Network Cable to the LAN1 Port on the G4K's CPU Module to your LAN Local Network Outlet:

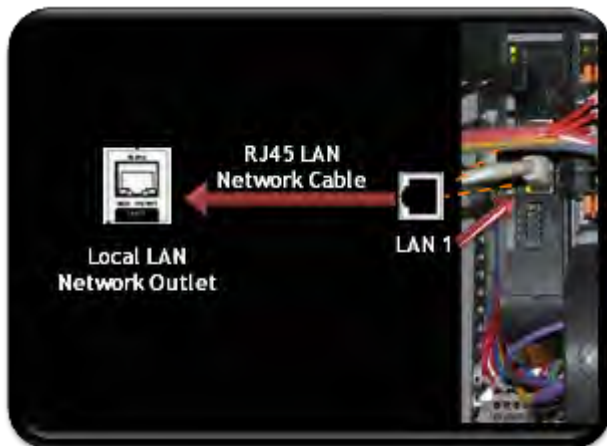

CONNECT THE G4K DIRECTLY TO THE PC

- Disconnect the network cable linking your PC/Laptop to the server network
- Using the same cable (RJ45 LAN Network Cable), connect to the port marked LAN1 G4K's CPU Module:

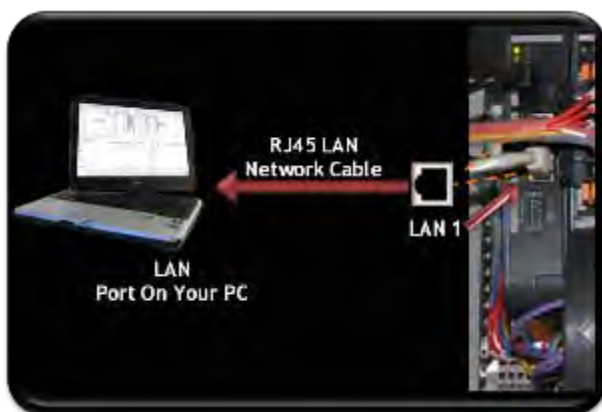

- The green link-LED of the LAN1 connector begins to flash as Windows begins communicating with the unit
- Wait for about 2 minutes as the Windows operating system reverts to the default "No Server" IP configuration

- When this is completed, the "Local Area Connection Status" icon in the "Quick Start" tray will change to "Limited or no connectivity":

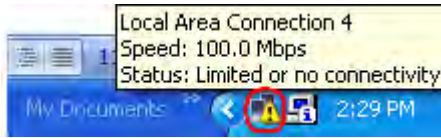

SEE ALSO

- [Installation](#)
- [G4K Unit Mounting BLACKBOX](#)
- [G4K Wiring BLACKBOX](#)
- [Confirm Operation](#)
- [G4K Unit Access](#)
- [G4K Configuration](#)
- [Verifying Measurement Readings](#)
- [Enable PQZIP Recording](#)





Confirm Operation

Confirm that your G4K Device is operating & that all the connections are working with the following indicators:

- Turn on the power supplying the unit
- The LEDs on the power supply light up:



- Verify the unit is operating correctly with reference to the following table:

LED	DESCRIPTION
	G4K PS Module: Green signals that external power exists. Red signals external power is out; unit will soon cease to function (25 seconds max.)
	G4K DSP Module: Blinking green signals normal operation and system boot
	G4K Main CPU Module: Green signals normal operation
	Blinking Red: During Shutdown process
	Constant Red: While Alarm is active (based on Alarm Configuration) may signal malfunction.

NOTE NOTE NOTE ...

- After powering up, wait at least one minute until the startup process is complete
- The red indicator light will remain on until the PQZIP is enabled by the user. See Also: [Enable PQZIP Recording](#)

SEE ALSO

- [Installation](#)
- [G4K Unit Mounting BLACKBOX](#)
- [G4K Wiring BLACKBOX](#)
- [Establish 1st Time Connection](#)
- [G4K Unit Access](#)
- [G4K Configuration](#)
- [Verifying Measurement Readings](#)
- [Enable PQZIP Recording](#)

G4K Unit Access

Once you have [Connected the Device for the 1st Time](#), you may access your G4K Unit by simply clicking the WEB Hyperlink button in your [Elspec's Search Utility](#). Alternatively you can simply access the device directly via Internet Explorer by inserting the Device's IP address directly (address is also indicated in [Elspec's Search Utility](#)). The Default IP Address for a newly supplied G4K unit is: 169.254.249.247.

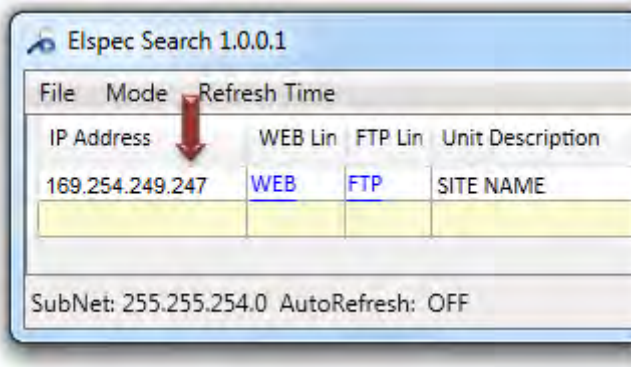

ACCESS ELSPEC'S SEARCH UTILITY:

- After you have [Copied the Utility](#) on your Desktop, access it by clicking on the Elspec's Search Icon:



- Initially, the program may trigger a verification warning similar to the one below. You may proceed by clicking Run
- As can procedure is initiated; the Elspec Search utility appears as a grid displaying all BLACKBOX devices found on the intranet network:

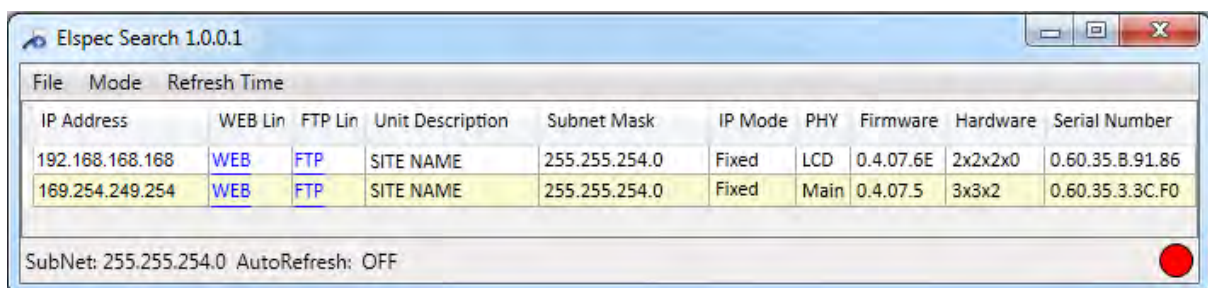

ACCESS INSTRUMENT VIA THE WEB HYPERLINK (RECOMMENDED):

- Select the Web link for your device, Elspec's Web Interface will now open:



- In order to view the different languages in the Web Interface, you will need to upload the language feature from [Elspec's Website](#) when installing your new Firmware. Once uploaded, simply select the applicable interface language from the drop-down list:



- The supported languages are:

- English (Default)
- Russian
- German
- Spanish
- French
- Chinese

(For other languages - please contact your local Elspec distributor)

- The Password field defines user level/privileges. The user levels are Viewer / Administrator (See [Security Settings](#)). The default password including privileges for each level are:
 - Viewer is 123 (Read only, can choose interface language only, no operations related changes are allowed)
 - Administrator is 12345 (Administration, setup & full control)

NOTE NOTE NOTE

- The Website is optimized to work with Internet Explorer 7, 8 or 9 in "Compatibility View". Ensure that the Internet Explorer is running in Compatibility View:



Other web browser applications can limit some functionality and/or show an incorrect layout.

- For local networking the browser should be configured as working without a proxy server. Refer to Disable Proxy Server in Internet Explorer.
- Should you be running Skype simultaneously with [Elspec's Search](#), you will not be able to access the device via the Web Link. Close Skype & access Elspec's Search again to follow the [Web Link](#).
- The passwords above are factory default values. You are advised to modify Admin password if extended security measures are required (See [Security Settings](#)).

DIRECT INSTRUMENT ACCESS VIA INTERNET EXPLORER

Access the device by typing the G4K's IP address in the address field in Internet Explorer:

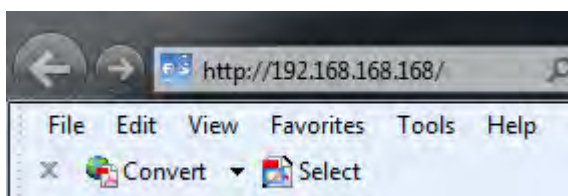

- Choose the language & enter the password as outlined above

SEE ALSO

- [Installation](#)
- [G4K Unit Mounting BLACKBOX](#)
- [G4K Wiring BLACKBOX](#)
- [Establish 1st Time Connection](#)
- [Confirm Operation](#)
- [G4K Configuration](#)
- [Verifying Measurement Readings](#)

G4K Quick Configuration

This section focuses only on the major configurations needed for initial installation of your G4K device. For a more detailed & comprehensive procedure see [Instrument Settings](#). This procedure includes a quick & simple configuration procedure for you:

- [G4K Unit](#)
- [Voltage & Frequency](#)
- [Currents](#)

SEE ALSO

- [Installation](#)
- [G4K BLACKBOX Unit Mounting](#)
- [G4K Wiring BLACKBOX](#)
- [Establish 1st Time Connection](#)
- [Confirm Operation](#)
- [G4K Unit Access](#)
- [Verifying Measurement Readings](#)
- [Enable PQZIP Recording](#)

G4K Unit Setup

[Access](#) your G4K Device via Elspec's Web Interface → log on as the Administrator (Manufacturer's Default Passwords are: 12345 (Admin), & 123 (Viewer)) → under Configuration → Device Setup select the Device Info Tab:

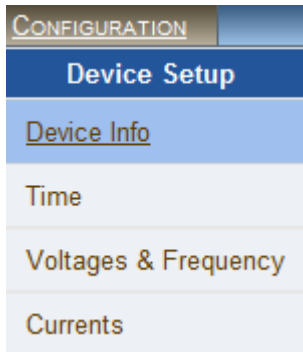

- In the G4 Unit Configuration Section complete:
 - Site Name: Enables the user to include a description of the site where the device is installed. This site description also appears in the Elspec's Search utility under Unit Description when searching for devices
 - Description: An additional text field for you to use optionally as you see fit
 - Operator: A text field for inputting an operator/technician's name
 - Company: A text field for inputting company's name

G4 Unit Configuration	
Site Name	<input type="text" value="Elspec Site 1"/>
Description	<input type="text" value="PQ Measurements"/>
Operator	<input type="text" value="Elspec Admin"/>
Company	<input type="text" value="Elspec Ltd."/>

- To apply your changes select [Apply Changes](#)

NOTE NOTE NOTE

- If you are not logged on as the Administrator, you will not be able to change any of these settings & you will receive the following error message in your attempt to do so:

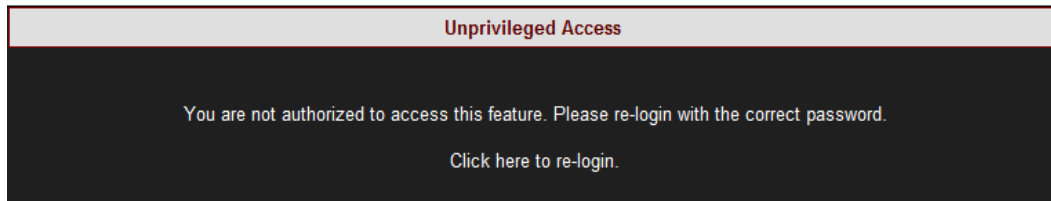

- Once you have signed on at the Administrator ensure that you select [Apply Changes](#) to affect your changes.

- Go to the next step [Configuring Voltage & Frequency](#)

SEE ALSO

- [Instrument Settings](#)
- [G4K Unit Setup](#)
- [Voltage & Frequency Configurations](#)
- [Currents](#)

Voltage & Frequency Configurations

The Voltage & Frequency Window defines all the major configurations regarding the [Voltage & Frequency values](#), for a more comprehensive procedure see [Voltage & Frequency](#).

- [Access](#) your G4K Device via Elspec's Web Interface → log on as the Administrator → under Configuration → Device Setup select the Voltage & Frequency Tab:

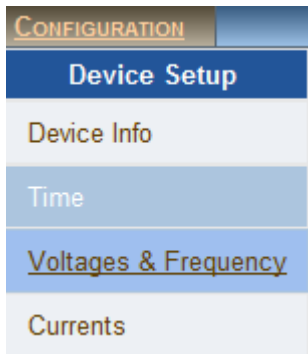

- In the Voltage & Frequency Window:

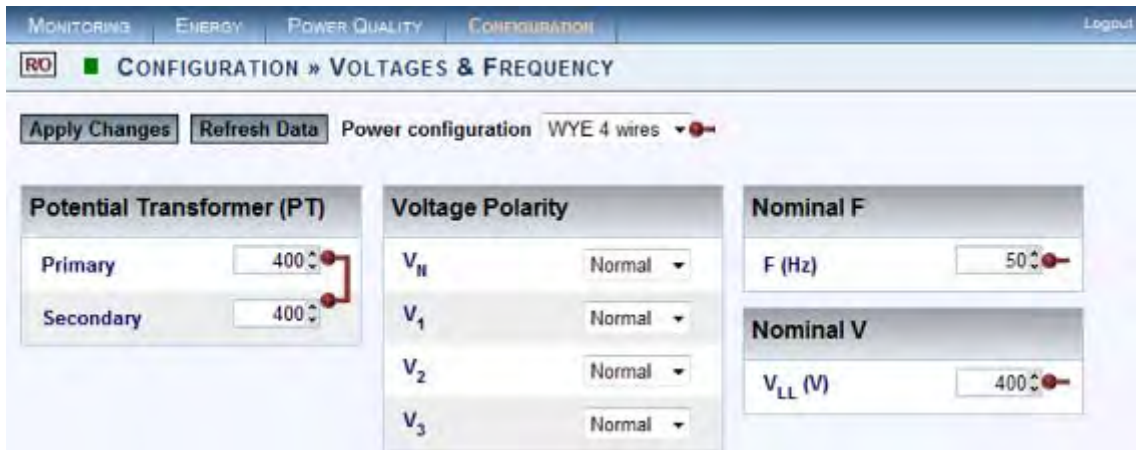

- Select the applicable [Network Type Settings](#) according to your network type from the drop-down selection:

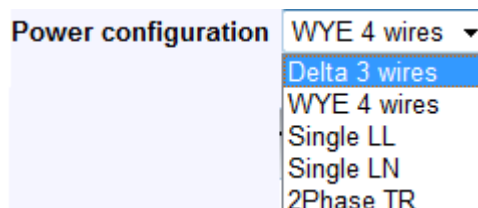

- For MV/HV Networks (Voltage Measurements by PT's) set the correct Primary & Secondary Ratio (with ▲/▼) - according to the PT Manufacturer's Specifications & not just the Ratio:

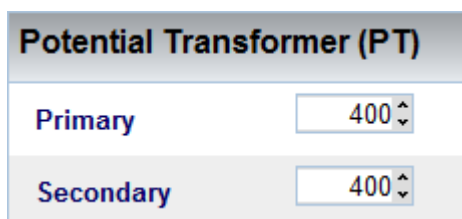

If the PT Ratio is inapplicable, then set your values to read:

- Define the Nominal Values for Frequency (F) and Voltages (V) (with ▲/▼):

Nominal F	
F (Hz)	50 ▲▼

Nominal V	
V _{LL} (V)	400 ▲▼

- The ratio for LV Networks is based on the same concept & specifications -

Set the Primary & Secondary Ratio (with ▲/▼) (according to the PT Manufacturer's Specifications & not just the Ratio):

Potential Transformer (PT)	
Primary	5 ▲▼
Secondary	1 ▲▼

Define the Nominal Values for Frequency (F) and Voltages (V) (with ▲/▼):

Nominal F	
F (Hz)	50 ▲▼
Nominal V	
V _{LL} (V)	230 ▲▼

- To apply your changes select [Apply Changes](#)

NOTE NOTE NOTE

- If you are not logged on as the Administrator, you will not be able to change any of these settings & you will receive the following error message in your attempt to do so:

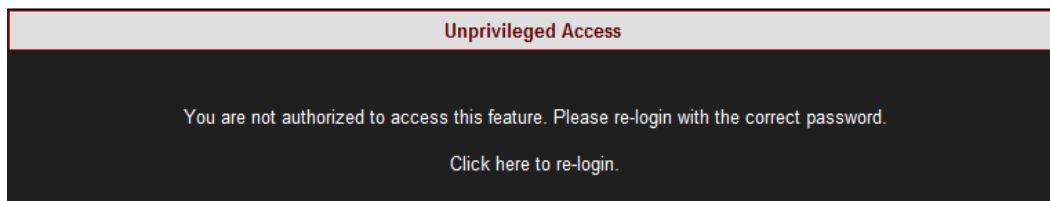

- Once you have signed on as the Administrator ensure that you select [Apply Changes](#) to actually affect your changes.

- Go to the next step [Current Configuration](#)

SEE ALSO

- [Instrument Settings](#)
- [G4K Unit Setup](#)
- [Voltage & Frequency Configurations](#)

Currents

In the Current Window you will be able to define all the major configurations for the [Current Values](#), for a more comprehensive procedure see [Currents](#).

- [Access](#) your G 4K D evice v ia Elspec's Web Interface → log o n a s t h e Administrator (Manufacturer's D efault P assword is : 12345) → under Configuration → Device Setup select the Currents Tab:

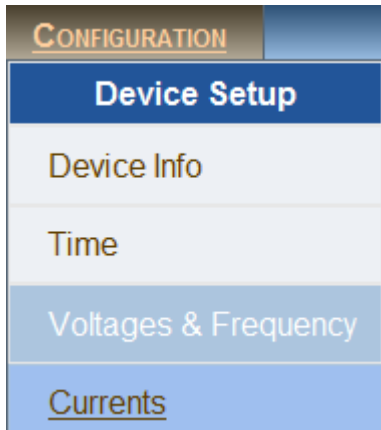

- In the Currents Window:

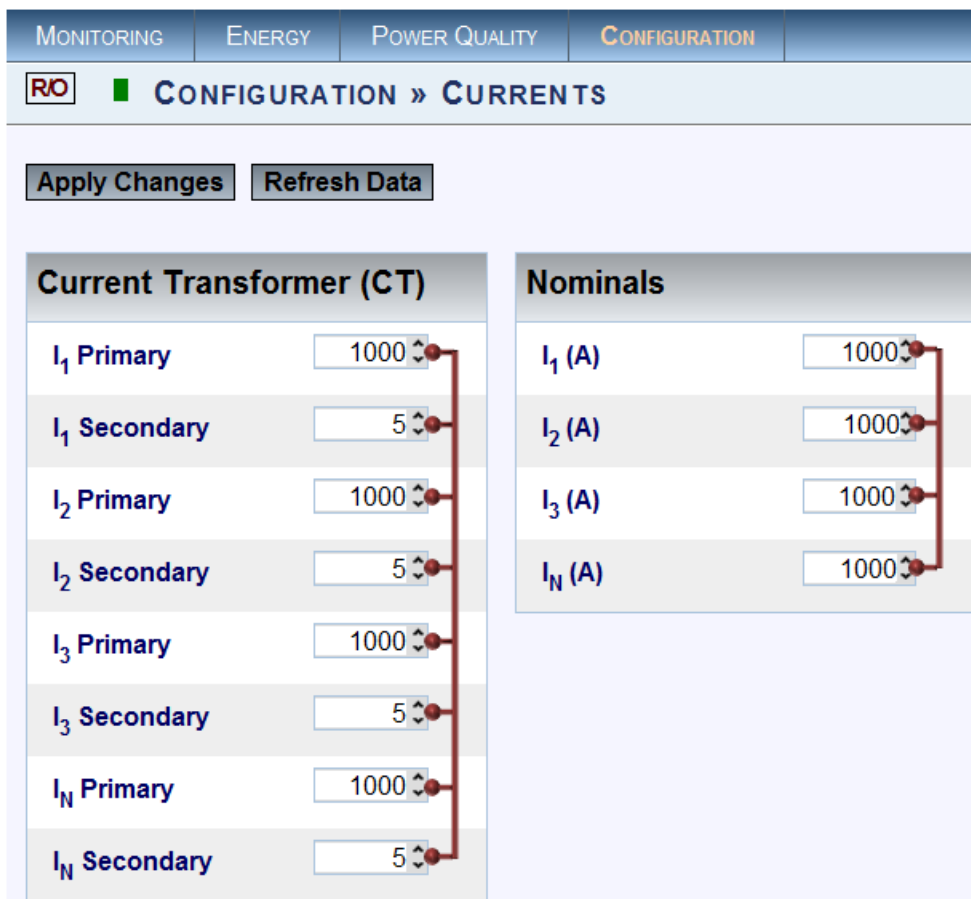

- Set the correct Primary & Secondary Transformation Ratios for all the Current channels from I₁ to I_N (with ▲/▼) - according to the CT Manufacturer's Specifications & not just the Ratio:

Current Transformer (CT)	
I_1 Primary	1000
I_1 Secondary	5
I_2 Primary	1000
I_2 Secondary	5
I_3 Primary	1000
I_3 Secondary	5
I_N Primary	1000
I_N Secondary	5

- Define the Nominal Values for all the Current Channels from I_1 to I_N (with ▲/▼):

Nominals	
I_1 (A)	1000
I_2 (A)	1000
I_3 (A)	1000
I_N (A)	1000

If the CT Ratio is inapplicable, then set your values to read:
 Primary = Secondary = Nominal

- To apply your changes select [Apply Changes](#)

NOTE NOTE NOTE

- The Nominal Values define both the [Event Level](#) as well as the measurement range. The maximum measured value is 16 times the nominal.
- If you are not logged on as the Administrator, you will not be able to change any of these settings & you will receive the following error message in your attempt to do so:

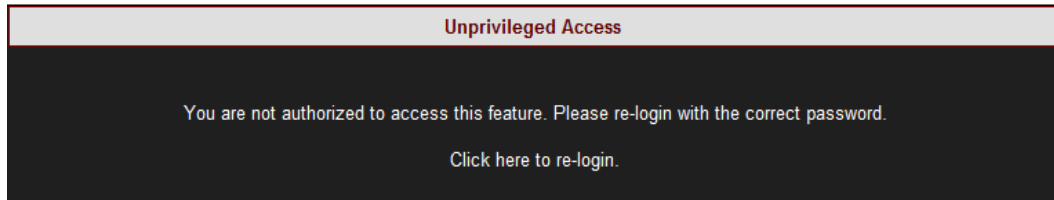

- Once you have signed on at the Administrator ensure that you select [Apply Changes](#) to actually affect your changes.

SEE ALSO

- [Instrument Settings](#)
- [G4K Unit Setup](#)
- [Voltage & Frequency Configurations](#)

Verify Measurement Readings

The final step after you have [Configured your Device](#), is to verify the voltage & current measurements of your G4K Unit. This verification step covers only a partial section of the [G4K's Full PQ Monitoring Capabilities](#). It includes:

- [Accessing & Reviewing the Measurement Summary](#)
- [Monitoring Voltage & Current Measurements](#)
- [Monitoring the Power](#)

SEE ALSO

- [Installation](#)
- [G4K Unit Mounting BLACKBOX](#)
- [G4K Wiring BLACKBOX](#)
- [Establish 1st Time Connection](#)
- [Confirm Operation](#)
- [G4K Unit Access](#)
- [G4K Configuration](#)
- [Enable PQZIP Recording](#)

Access the Measurement Summary

The Measurement Summary summarizes all your measurement readings. The most important parameters you will need to focus on in this window are Phase Order (for 3 phase systems) & DSP Synchronization:

- **Phase Order:** Confirms the order of the voltage phases starts from V_1 & are moving in a clockwise direction. If the Phase Order is incorrect (not 123) recheck your [Voltage Connections](#) & that they are connected in the correct order.
- **DSP Synchronization:** Confirms that the unit is synchronized with the signals of the device. If this is ON it means that the device is reading all the signals in a synchronized manner, & if it is OFF it means that the device is not reading the signals. In this instance recheck all your [Connections](#).
- See [PQM monitoring](#) for all the definitions & subsequent parameter calculations that appear on this window.

ACCESS THE SUMMARY WINDOW

- [Access your G4K Unit](#) via the Web Interface → Open Monitoring

→ Summary:

MONITORING	ENERGY	POWER QUALITY	C
Summary		V & I harmonics	
Voltage & Current		P & Q harmonics	
Average		Spectrum	
Power		Harmonics Table	
Temperature		V/I Min/Max Harmonics	
Phasors		P/Q Min/Max Harmonics	
Waveforms			
Voltage Flickering			
Pinst Waveform			
Min/Max Flickering			

- The Summary Window will now open:

The screenshot shows a software window titled "MONITORING » SUMMARY". It contains two main sections: "Summary" and "Synchronization Status".

Summary	
Frequency	62.002 Hz
I_{avg}	0.5000 A
$V(LL)_{avg}$	207.80 V
$V(LN)_{avg}$	119.98 V
Power factor _{total}	1.0000
Phase Order	123

See explanation on Phase Order above.

Synchronization Status	
Time Synchronization	Self No time synchronization
DSP Synchronization	On

See explanation on DSP Synchronization above.

SEE ALSO

- [Verify Measurement Readings](#)
- [Verify Voltage & Current Readings](#)
- [Verify Power Readings](#)
- [About PQ Monitoring](#)

Verify Voltage & Current Readings

This page displays specific values for voltage and current as per the parameters set when you [Configured your G4K Unit](#). For a full description on all the definitions & subsequent parameter calculations see [Voltage & Current](#).

- [Access your G4K Unit](#) via the Web Interface ➡ Open Monitoring ➡ Voltage & Current:

MONITORING	ENERGY	POWER QUALITY	CONFIGURATION
Summary		V & I harmonics	
<u>Voltage & Current</u>		P & Q harmonics	
Average		Spectrum	
Power		Harmonics Table	
Temperature		V/I Min/Max Harmonics	
Phasors		P/Q Min/Max Harmonics	
Waveforms			
Voltage Flickering			
Pinst Waveform			
Min/Max Flickering			

- Verify that the RMS values for both Voltage & Current are as per your [Configurations](#):

MONITORING	ENERGY	POWER QUALITY	CONFIGURATION	Logout		
MONITORING » VOLTAGE & CURRENT						
Reset All Min/Max						
V/I <input type="checkbox"/> PU						
	RMS	Min Value	Max Value	THD	Crest Factor	K Factor
V ₁	119.98 V	0.0000 V	604.67 V	0.9412 %	42.121	---
V ₂	120.12 V	0.0000 V	601.69 V	1.0383 %	42.776	---
V ₃	120.01 V	0.0000 V	599.73 V	0.7002 %	40.873	---
V _N	0.0758 V	0.0000 V	0.5565 V	----	----	---
V ₁₂	208.06 V	0.0000 V	1.0374 kV	0.7973 %	41.250	---
V ₂₃	207.83 V	0.0000 V	917.89 V	0.7580 %	41.136	---
V ₃₁	207.55 V	0.0000 V	813.71 V	0.6060 %	40.452	---
I ₁	0.5000 A	0.0000 A	9.8172 A	0.9410 %	42.145	1.0082
I ₂	0.5006 A	0.0000 A	8.4936 A	1.0528 %	42.846	1.0104
I ₃	0.5001 A	0.0000 A	8.2329 A	0.7116 %	40.869	1.0042
I _N	0.5001 A	0.0000 A	8.4703 A	0.7065 %	40.956	1.0041

- Go to the next step - Verifying your Power as per your [Configurations](#)

SEE ALSO

- [Verify Measurement Readings](#)
- [Access the Measurement Summary](#)
- [Verify Power Readings](#)
- [About PQ Monitoring](#)

Verify Power Readings

This page displays specific values for the different [Electrical Power Parameters](#) relevant to the [Specific Power Configuration](#). For a full description on all the definitions & subsequent parameter calculations see [Power](#).

- [Access your G4K Unit](#) via the Web Interface → Open Monitoring → Power:

MONITORING	ENERGY	POWER QUALITY	C
Summary		V & I harmonics	
Voltage & Current		P & Q harmonics	
Average		Spectrum	
<u>Power</u>		Harmonics Table	
Temperature		V/I Min/Max Harmonics	
Phasors		P/Q Min/Max Harmonics	
Waveforms			
Voltage Flickering			
Pinst Waveform			
Min/Max Flickering			

	Active Power	Reactive Power	Apparent Power	True PF	Displacement PF
Phase 1	22.511 kW	3.5602 kVAr	22.791 kVA	0.9877 (Ind)	0.9938 (Ind)
Phase 2	14.906 kW	-2.7707 kVAr	15.161 kVA	0.9832 (Cap)	0.9961 (Cap)
Phase 3	13.527 kW	-1.9910 kVAr	13.673 kVA	0.9893 (Cap)	0.9975 (Cap)
Neutral	0.0000 kW	-0.0001 kVAr	0.0001 kVA	0.0027 (Cap)	---
Total	50.944 kW	-1.2015 kVAr	51.625 kVA	0.9868 (Cap)	0.9938 (Ind)

- Verify your [Configurations](#) in this window that displays:
 - Active Power
 - Reactive Power
 - Apparent Power
 - True & Displacement Power Factor

In most network configurations the Active Power will reflect a Positive Value. Should it have a Negative Value, recheck your [Voltage](#) & [Current Polarity Configuration](#). In the presence of a generator, the Active Power will reflect a Negative Value.

SEE ALSO

- [Verify Measurement Readings](#)
- [Access the Measurement Summary](#)
- [Verify Voltage & Current Readings](#)
- [About PQ Monitoring](#)

Enable PQZIP Recording

In order to record actual data for further analysis by PQSCADA & Investigator, you must first enable the [PQZIP Recording](#).

HOW TO ENABLE PQZIP RECORDING

- [Access your G4K Unit](#) via the Web Interface → Open Configuration → PQZIP Recording
- In the State drop-down selection select Enable:

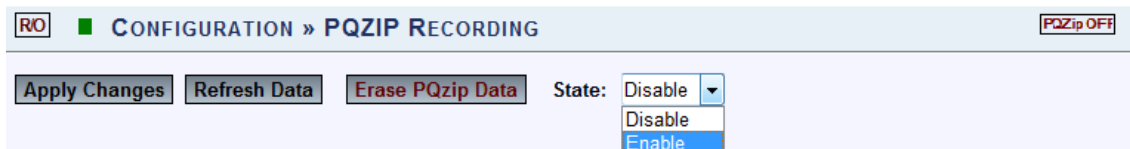

- To apply your changes select **Apply Changes**
- The following warning may appear if some parameter readings are inconsistent with the configuration. In this case make sure all parameters are correct before enabling the PQZIP:

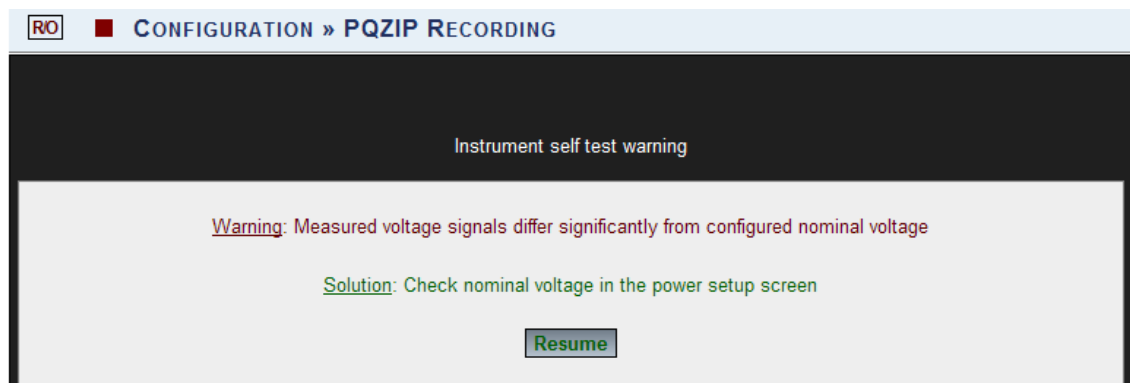

- Confirm by selecting **Resume** & the following success message will appear:

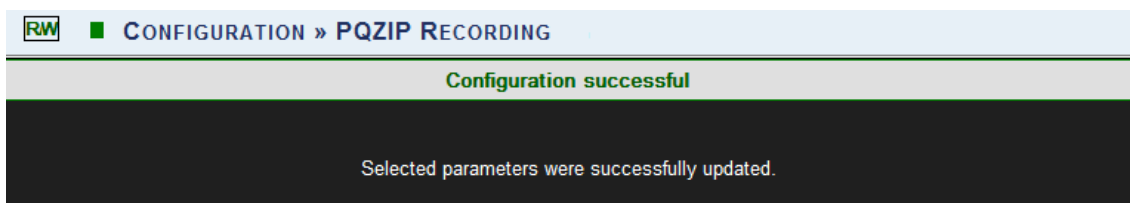

NOTE NOTE NOTE

- If you are not logged on as the Administrator, you will not be able to change any of these settings & you will receive the following error message in your attempt to do so:

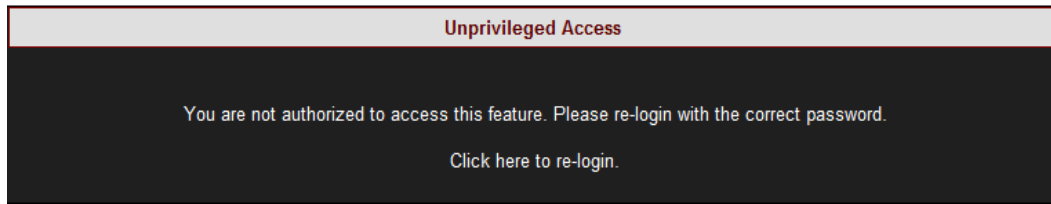

- Once you have signed on as the Administrator ensure that you select **Apply Changes** to actually affect your changes.

SEE ALSO

- [Installation](#)
- [G4K Unit Mounting BLACKBOX](#)
- [G4K Wiring BLACKBOX](#)
- [Establish 1st Time Connection](#)
- [Confirm Operation](#)
- [G4K Unit Access](#)
- [G4K Configuration](#)
- [Verifying Measurement Readings](#)
- [About PQ Monitoring](#)

Monitoring Real-Time Data

The Monitoring section displays real time readings and graphs of the grid's parameters. The graph display requires an ActiveX plug-in from Gigasoft that is downloadable either from [Elspec's Website's Support Section](#) or alternatively can be installed directly from your [BLACKBOX CD](#). The ActiveX plug-in allows different view options needed for your PQ Monitoring. In the PQ Monitoring Section you will be able to monitor the following PQ measurements of your G4K Unit:

- Total measurements in the Summary Window
- [Voltage & Current Measurements](#)
- [Average Measurements](#)
- [Power Measurements](#)
- [Internal & External Temperature Readings](#)
- [Voltage & Current Phase Diagrams](#)
- [Voltage & Current Waveforms](#)
- [Short & Long Term Voltage Flickering](#)
- [Flickering Waveforms](#)
- [Minimum & Maximum Flickering Values](#)
- [Voltage & Current Harmonics Spectrum](#)
- [Active & Reactive Harmonic Powers](#)
- [Voltage & Current Sub & Inter-Harmonics](#)
- [Voltage & Current Harmonics in Values & Angles](#)
- [Minimum, Maximum Values & Angles of Voltage & Current Harmonics](#)
- [Minimum & Maximum Values of Active & Reactive Power Harmonics](#)

ACCESS THE PQ MONITORING SUMMARY

- [Access your G4K Unit](#) via the Web Interface → Open Monitoring

→ Summary:

MONITORING	ENERGY	POWER QUALITY	C
Summary		V & I harmonics	
Voltage & Current		P & Q harmonics	
Average		Spectrum	
Power		Harmonics Table	
Temperature		V/I Min/Max Harmonics	
Phasors		P/Q Min/Max Harmonics	
Waveforms			
Voltage Flickering			
Pinst Waveform			
Min/Max Flickering			

- The Summary & Synchronization Status Window will now open:

RO ■ MONITORING » SUMMARY		
Summary □ PU		
Frequency	62.002 Hz	
I_{avg}	0.5000 A	
$V(LL)_{avg}$	207.80 V	
$V(LN)_{avg}$	119.98 V	
Power factor _{total}	1.0000	
Phase Order	123	
Synchronization Status		
Time Synchronization	Main	Good
DSP Synchronization	On	

The table outlines the sections' Parameters including Definition:

PARAMETER	DEFINITION
SUMMARY WINDOW	
Frequency	The number of cycles per second
I_{AVG}	The current in a single phase system or the current averaged over all three phases in a three phase system
$V(LL)_{AVG}$	Line to line voltage averaged over all three phases in a three phase system
$V(LN)_{AVG}$	Line to neutral voltage averaged over the three phases
Power Factor _{TOTAL}	Total True Power Factor over three phases, averaged by default over 1 minute
Phase Order	Confirms the order of the voltage phases starts from V_1 & are moving in a clockwise direction. If the Phase Order is incorrect (not 123) recheck your Voltage Connections & that they are connected in the correct order
SYNCHRONIZATION STATUS	
Time Synchronization	Indicates the connection quality to the time source. This connection supplies the instrument with world time (UTC) from a time source. The Time Sync quality is essential to PQZIP coherent file generation
DSP Synchronization	Confirms that the unit is synchronized with the signals of the device. If this is ON it means that the device is reading all the signals in a synchronized manner, & if it is OFF it means that the device is not reading the signals. In this instance recheck all your Connections , Network Communication , & Device Configurations .

Voltage & Current Measurements

This page displays specific values for Voltage & Current Measurements at a 10/12 cycle resolution. The viewed parameters depend on how your [G4K Unit has been Configured](#).

- [Access your G4K Unit](#) via the Web Interface → select Monitoring → Voltage & Current:

MONITORING	ENERGY	POWER QUALITY
Summary		V & I harmonics
<u>Voltage & Current</u>		P & Q harmonics
Average		Spectrum
Power		Harmonics Table
Temperature		V/I Min/Max Harmonics
Phasors		P/Q Min/Max Harmonics
Waveforms		
Voltage Flickering		
Pinst Waveform		
Min/Max Flickering		

- The Voltage & Current PQ Monitoring Window will now open

VOLTAGE & CURRENT SECTION (RMS, MIN/MAX VALUE, THD, CREST FACTOR, K FACTOR)

V/I <input type="checkbox"/> PU						
	RMS	Min Value	Max Value	THD	Crest Factor	K Factor
V ₁₂	403.1893 V	381.5403 V	420.2249 V	1.713893 %	1.448701	---
V ₂₃	404.3133 V	383.9400 V	421.8228 V	1.821636 %	1.450176	---
V ₃₁	403.2043 V	383.6008 V	420.2467 V	1.614527 %	1.447160	---
I ₁	97.64386 A	43.89695 A	728.5047 A	7.002274 %	1.432072	1.295215
I ₂	53.23956 A	17.21198 A	719.1996 A	14.46074 %	1.779383	1.805157
I ₃	62.10047 A	32.43429 A	342.1426 A	12.28039 %	1.704414	1.499499
I ₁₂	20.71540 A	10.81033 A	114.0386 A	12.27157 %	1.703125	1.493802
I ₂₃	32.34406 A	14.63008 A	242.8318 A	7.073332 %	1.430983	1.288402
I ₃₁	51.18102 A	24.85549 A	290.8023 A	7.955546 %	1.502144	1.298753

The table outlines the sections' Parameters including Definition:

PARAMETER	DEFINITION
PU	By selecting PU (Per Unit) will present the values as part of nominal (for example: 230V → 100.0%)
VRMS	$V_{RMS_x} = \sqrt{\sum_{n=1} ((V \cos \varphi)^2 + (V \sin \varphi)^2)}$ <p>n = Number of Samples x = Specific Channel 10/12 Continuous Non-Overlapping Cycles In Accordance with IEC61000-4-30</p>
ARMS	$I_{RMS_x} = \sqrt{\sum_{n=1} ((I \cos \varphi)^2 + (I \sin \varphi)^2)}$ <p>n = Number of Samples x = Specific Channel 10/12 Continuous Non-Overlapping Cycles In Accordance with IEC61000-4-30</p>
Min Value	Minimum RMS value since the initial power up or the most recent selection of: Reset All Min/Max
Max Value	Maximum RMS value since the initial power up or the most recent selection of: Reset All Min/Max
THD	$\sqrt{\frac{\sum_{n=2}^{50} C_n^2}{C_1^2}}$ <p>C = Harmonic RMS Value n = Harmonic Order</p>

PARAMETER	DEFINITION
V Crest Factor	$\frac{V_{PEAK}}{V_{RMS}}$ <p>Measures Ratio Between the VPEAK and VRMS</p>
A Crest Factor	$\frac{I_{peak}}{I_{RMS}}$ <p>Measures ratio between the IPEAK & ARMS</p>
K-Factor	$\frac{\sum_{n=1}^{25} (i_n * n)^2}{\sum_{n=1}^{25} i_n^2}$ <p>Where n is the Harmonic #, and i_n is the RMS value of the n^{TH} Harmonic</p>

VOLTAGE & CURRENT SECTION (TDD, THD EVEN, THD ODD, OVER-DEVIATION, UNDER DEVIATION)

VII					
	TDD	THD Even	THD Odd	Over-deviation	Under-deviation
V ₁₂	---	0.047130 %	1.725974 %	403.3856 V	400.0000 V
V ₂₃	---	0.000000 %	1.826259 %	404.4132 V	400.0000 V
V ₃₁	---	0.018985 %	1.638437 %	403.2502 V	400.0000 V
I ₁	1.502666 %	0.955213 %	6.996640 %	---	---
I ₂	3.085502 %	0.872712 %	15.01078 %	---	---
I ₃	2.909767 %	0.854348 %	12.13882 %	---	---
I ₁₂	1.886250 %	0.896957 %	12.28748 %	---	---
I ₂₃	1.524358 %	0.918502 %	7.010171 %	---	---
I ₃₁	1.774584 %	0.918934 %	7.902488 %	---	---

The table outlines the sections' Parameters including Calculation:

PARAMETER	DEFINITION
TDD	<p>Total Demand Distortion - TDD - is the current distortion (harmonics above the 1st) as a percent of maximum demand load. TDD is defined using the following relationship:</p> $I_{TDD} = \sqrt{\sum_{h=2}^{\infty} \left[\frac{I_h^2}{I_L^2} \right]} * 100\%$
THD Even	$\sqrt{\frac{\sum_1^{25} C_{2n}^2}{C_1^2}}$ <p>C = Harmonic RMS Value n = Harmonic Order</p>
THD Odd	$\sqrt{\frac{\sum_1^{25} C_{2n+1}^2}{C_1^2}}$ <p>C = Harmonic RMS Value n = Harmonic Order</p>
Over-Deviation	The Over-Deviation indicates how much higher the RMS Voltage is than the Reference Voltage
Under-Deviation	The Under-Deviation indicates how much lower the RMS Voltage is than the Reference Voltage

UNBALANCE SECTION (AVG, MIN, MAX)

Unbalance			
	Avg.	Min.	Max.
U- Unbalance	0.178926 %	0.009094 %	1.555625 %
U+ Positive Sequence	570.5154 V	541.6784 V	594.8457 V
U- Negative Sequence	1.020798 V	0.051402 V	8.629082 V
U0 Sequence	0.000000 V	0.000000 V	0.000000 V
U0 Zero sequence ratio	0.000000 %	0.000000 %	0.000000 %
I- Unbalance	75.21848 %	54.05648 %	312.7102 %
I+ Positive Sequence	71.27623 A	26.82935 A	307.0463 A
I- Negative Sequence	53.61290 A	25.86587 A	238.4883 A
I0 Zero sequence	48.62730 A	14.82024 A	235.9982 A
I0 Zero sequence ratio	68.22372 %	23.88593 %	449.3273 %

The table outlines the sections' Parameters including Calculation:

PARAMETER	DEFINITION
Unbalance	$Unbalance = \left[\frac{I_n}{I_p} \right] * 100$ <p>The Supply Voltage Unbalance is Evaluated Using the Method of Symmetrical Components in Accordance with IEC61000-4-30</p>
Unbalance Avg.	The Average Supply Voltage Unbalance is Evaluated Using the Method of Symmetrical Components in Accordance with IEC61000-4-30
Unbalance Min.	The Minimum Supply Voltage Unbalance is Evaluated Using the Method of Symmetrical Components in Accordance with IEC61000-4-30
Unbalance Max.	The Maximum Supply Voltage Unbalance is Evaluated Using the Method of Symmetrical Components in Accordance with IEC61000-4-30
Zero Sequence Unbalance	$U_0 = \left \frac{u_0}{u_1} \right * 100$
Negative Sequence Unbalance	$U_2 = \left \frac{u_2}{u_1} \right * 100$
Positive Sequence	<p>Defined as the symmetrical vector system derived by application of the Fortescue's transformation matrix, and that rotates in the same direction as the power frequency voltage (or current):</p> $\underline{U}_1 = \frac{1}{3} (\underline{U}_a + \underline{a} \cdot \underline{U}_b + \underline{a}^2 \cdot \underline{U}_c)$ <p>where $\underline{a} = 1 \angle 120^\circ = -\frac{1}{2} + j \frac{\sqrt{3}}{2}$ and $\underline{U}_a, \underline{U}_b, \underline{U}_c$ and are line to neutral voltages (fundamental component)</p> <p>In Accordance With IEC61000-3-13, ed. 1.0 (2008-02) Ref: 3.26.3</p>
Negative Sequence	<p>Defined as the symmetrical vector system derived by application of the Fortescue's transformation matrix, and that rotates in the opposite direction to the power frequency voltage (or current):</p> $\underline{U}_1 = \frac{1}{3} (\underline{U}_a + \underline{a}^2 \cdot \underline{U}_b + \underline{a} \cdot \underline{U}_c)$ <p>where $\underline{a} = 1 \angle 120^\circ = -\frac{1}{2} + j \frac{\sqrt{3}}{2}$ and $\underline{U}_a, \underline{U}_b, \underline{U}_c$ and are line to neutral voltages (fundamental component)</p> <p>In Accordance With IEC61000-3-13, ed. 1.0 (2008-02) Ref: 3.26.4</p>
Zero Sequence	<p>Defined as the in-phase symmetrical vector system derived by application of the Fortescue's transformation matrix:</p> $\underline{U}_0 = \frac{1}{3} (\underline{U}_a + \underline{U}_b + \underline{U}_c)$ <p>where $\underline{U}_a, \underline{U}_b, \underline{U}_c$ and are line to neutral voltages (fundamental component)</p> <p>In Accordance With IEC61000-3-13, ed. 1.0 (2008-02) Ref: 3.26.5</p>

SEE ALSO

- [Monitoring Real-Time Data](#)
- [Average](#)
- [Power](#)
- [Temperature](#)
- [Phasors](#)
- [Waveforms](#)
- [Voltage Flickering](#)
- [Pinst Waveform](#)
- [Minimum / Maximum Flickering](#)
- [Voltage & Current Harmonics](#)
- [P & Q Harmonics](#)
- [Spectrum](#)
- [Harmonics Table](#)
- [Voltage & Current, Min & Max Harmonics Table](#)
- [PQ Min & Maximum Harmonics](#)

Averaging

In accordance to the IEC-61000-4-30 measurement standards, the G4K BLACKBOX displays the following Average Measurements: Aggregation of 150/180 cycles (3seconds); 10 minutes & 2 hours based at a Frequency of 10 minutes. This window also displays the Flagging based on [PQ configurations](#).

OPEN THE AVERAGE WINDOW

- [Access your G4K Unit](#) via the Web Interface → select Monitoring

→ Average:

MONITORING	ENERGY	POWER QUALITY
Summary		V & I harmonics
Voltage & Current		P & Q harmonics
<u>Average</u>		Spectrum
Power		Harmonics Table
Temperature		V/I Min/Max Harmonics
Phasors		P/Q Min/Max Harmonics
Waveforms		
Voltage Flickering		
Pinst Waveform		
Min/Max Flickering		

- The Average Window will now open:

MONITORING » AVERAGE			
Frequency			
Frequency _{Over 10 sec}		50.03945 Hz	
Averages			
	150/180 Cycles	10 Min.	2 Hours
Timestamp	09/09/2010 19:17:25	09/09/2010 19:10:00	09/09/2010 18:00:00
Flag	Not flagged	Not flagged	Not flagged
V ₁₂	398.5608 V	399.0757 V	403.1885 V
V ₂₃	399.9994 V	400.5039 V	404.6771 V
V ₃₁	398.2115 V	398.7762 V	402.8430 V
Under-deviation			
	150/180 Cycles	10 Min.	2 Hours
V ₁₂	0.364090 %	0.214424 %	0.000000 %
V ₂₃	0.009476 %	0.000015 %	0.000000 %
V ₃₁	0.448929 %	0.289368 %	0.000000 %
Over-deviation			
	150/180 Cycles	10 Min.	2 Hours
V ₁₂	0.000000 %	0.000000 %	0.860155 %
V ₂₃	0.008804 %	0.142685 %	1.210514 %
V ₃₁	0.000000 %	0.000000 %	0.780482 %
Unbalance			
	150/180 Cycles	10 Min.	2 Hours
U ₋ Unbalance	0.271891 %	0.265798 %	0.280349 %
U ₊ Positive Sequence	564.0493 V	564.9013 V	570.7029 V
U ₋ Negative Sequence	1.533599 V	1.501438 V	1.599186 V
U ₀ Sequence	0.000000 V	0.000000 V	0.000000 V
U ₀ Zero sequence ratio	0.000000 %	0.000000 %	0.000000 %
i ₋ Unbalance	79.18645 %	78.54414 %	80.40035 %
I ₊ Positive Sequence	36.44508 A	36.51681 A	36.32321 A
I ₋ Negative Sequence	28.85961 A	28.54987 A	29.20407 A
I ₀ Zero sequence	20.54771 A	20.55655 A	19.71203 A
i ₀ Zero sequence ratio	56.38018 %	56.56672 %	54.26545 %

The table outlines the sections' Parameters including Definition:

PARAMETER	DEFINITION
Frequency	Frequency - 10 seconds averaging
Average 150/180 Cycles	Average Measurements at an aggregation of 150/180 cycles (~3seconds)
Average 10 Min.	Average Measurements at an aggregation of 10 minutes
Average 2 Hours	Average Measurements at an aggregation of 2 hours
Under Deviation 150/180 Cycles	Displays how much lower the Average RMS Voltage is than the Reference Voltage at an aggregation of 150/180 cycles (~3seconds)
Under Deviation 10 Min.	Displays how much lower the Average RMS Voltage is than the Reference Voltage at an aggregation of 10 minutes
Under Deviation 2 Hours	Displays how much lower the Average RMS Voltage is than the Reference Voltage at an aggregation of 2 hours
Over Deviation 150/180 Cycles	Displays how much higher the Average RMS Voltage is than the Reference Voltage at an aggregation of 150/180 cycles (~3seconds)
Over Deviation 10 Min.	Displays how much higher the Average RMS Voltage is than the Reference Voltage at an aggregation of 10 minutes
Over Deviation 2 Hours	Displays how much higher the Average RMS Voltage is than the Reference Voltage at an aggregation of 2 hours
Unbalance 150/180 Cycles	<p>The Supply Voltage Unbalance is Evaluated Using the Method of Symmetrical Components in Accordance with IEC61000-4-30</p> $Unbalance = \left[\frac{I_n}{I_p} \right] * 100$ <p>This entry displays the Average Maximum/Minimum Unbalanced Values at an aggregation of 150/180 cycles (~3seconds)</p>
Unbalance 10 Min.	This entry displays the Average Maximum/Minimum Unbalanced Values at an aggregation of 10 minutes
Unbalance 2 Hours	This entry displays the Average Maximum/Minimum Unbalanced Values at an aggregation of 2 hours

SEE ALSO

- [Monitoring Real-Time Data](#)
- [Voltage & Current Measurements](#)
- [Power](#)
- [Temperature](#)
- [Phasors](#)
- [Waveforms](#)
- [Voltage Flickering](#)
- [Pinst Waveform](#)
- [Minimum / Maximum Flickering](#)
- [Voltage & Current Harmonics](#)
- [P & Q Harmonics](#)
- [Spectrum](#)
- [Harmonics Table](#)
- [Voltage & Current, Min & Max Harmonics Table](#)
- [PQ Min & Maximum Harmonics](#)

Power

This page displays different electrical power parameters relevant to the [Specific G4K Unit Configuration](#).

OPEN THE POWER SUMMARY WINDOW

- [Access your G4K Unit](#) via the Web Interface → select Monitoring → Power:

MONITORING	ENERGY	POWER QUALITY
Summary		V & I harmonics
Voltage & Current		P & Q harmonics
Average		Spectrum
Power		Harmonics Table
Temperature		V/I Min/Max Harmonics
Phasors		P/Q Min/Max Harmonics
Waveforms		
Voltage Flickering		
Pinst Waveform		
Min/Max Flickering		

- The Power Summary Window will now open:

Power Summary					
	Active Power	Reactive Power	Apparent Power	True PF	Displacement PF
Phase 1	22.511 kW	3.5602 kVAr	22.791 kVA	0.9877 (Ind)	0.9938 (Ind)
Phase 2	14.906 kW	-2.7707 kVAr	15.161 kVA	0.9832 (Cap)	0.9961 (Cap)
Phase 3	13.527 kW	-1.9910 kVAr	13.673 kVA	0.9893 (Cap)	0.9975 (Cap)
Neutral	0.0000 kW	-0.0001 kVAr	0.0001 kVA	0.0027 (Cap)	---
Total	50.944 kW	-1.2015 kVAr	51.625 kVA	0.9868 (Cap)	0.9938 (Ind)

Verify your [Configurations](#) in this window that displays:

- Active Power
- Reactive Power
- Apparent Power
- True & Displacement Power Factor

In most network configurations the Active Power will reflect a Positive Value. Should it have a Negative Value, recheck your [Voltage](#) & [Current Polarity Configuration](#). In the presence of a generator, the Active Power will reflect a Negative Value.

The table outlines the sections' Parameters including Definition:

PARAMETER	DEFINITION
Active Power	<p>The amount of Active Power consumed as usable energy. Sometimes referred to as Real Power. The portion of power flow that, averaged over a complete cycle of the AC waveform, results in the net transfer of energy in one direction expressed as kWh.</p> <p>In most network configurations the Active Power will reflect a Positive Value. Should it have a Negative Value, recheck your Voltage & Current Polarity Configuration. In the presence of a generator, the Active Power will reflect a Negative Value.</p> <p>Elspec calculates the Active Power accurately by taking all Harmonics up to the 40th into account using the following formula:</p> $P = \frac{1}{2} \sum_i V_{i,j} \cdot I_{i,j} \cdot \cos \theta_{i,j} \text{ [Watt]}$ <p>i = Harmonic j = Phase</p>
Reactive Power	<p>The amount of Reactive Power consumed as unusable energy. Energy that flows back and forth with no actual power flow. Reactive Power flow transfers no net energy to the load and is sometimes referred to as Wattless power. Elspec calculates reactive power using the following formula:</p> $Q = -P_q = - V I \sin \theta = -\vec{V} \times \vec{I} = \begin{vmatrix} \hat{i} & \hat{j} & \hat{k} \\ V_x & V_y & 0 \\ I_x & I_y & 0 \end{vmatrix} = \hat{k}(-V_x I_y + I_x V_y) \text{ [VAR]}$ <p>Elspec calculates the sign of Q using the following formula:</p> $\text{Sign of Q} = \text{sign of: } \left(\sum_i (-V_{xi} \cdot I_{yi} + V_{yi} \cdot I_{xi}) \right)$
Apparent Power	<p>The amount of Apparent Power; a vector addition of the Active and Reactive Power. The combination of active and reactive energy (kVAh)</p> <p>Elspec uses formula:</p> $S = V_{RMS} * I_{RMS} \text{ [VA]}$

PARAMETER	DEFINITION
True Power Factor (PF)	The ratio between Real Power & Apparent Power (a value between 0 and 1). The most accurate measure of efficiency is the True Power Factor. It is defined as the sum of the P/S ratio over all the Harmonics:
	$PF_{sign} = P_{sign} * Q_{sign}$
	<i>if $PF_{sign} > 0$ than IND; $PF_{sign} < 0$ than CAP</i>
	QUADRAT
	PF UNIT
I	+ + + IND
II	- + - CAP
III	- - + IND
IV	+ - - CAP
Displacement Power Factor (PF)	Same as True PF, But Only With Fundamental Components: $true PF = \left \frac{P_{h1}}{S_{h1}} \right , \text{if } Q > 0 \text{ than CAP; if } Q < 0 \text{ than IND}$

SEE ALSO

- [Monitoring Real-Time Data](#)
- [Voltage & Current Measurements](#)
- [Average](#)
- [Temperature](#)
- [Phasors](#)
- [Waveforms](#)
- [Voltage Flickering](#)
- [Pinst Waveform](#)
- [Minimum / Maximum Flickering](#)
- [Voltage & Current Harmonics](#)
- [P & Q Harmonics](#)
- [Spectrum](#)

- [Harmonics Table](#)
- [Voltage & Current, Min & Max Harmonics Table](#)
- [PQ Min & Maximum Harmonics](#)

Temperature

Ambient temperature is an important parameter both within an electrical cabinet and within your G4K BLACKBOX Unit. Temperature extremes do affect measuring accuracy. Therefore, monitoring the internal temperature of the instrument is important when monitoring all measured electrical parameters to ensure that the values can be assumed to be of maximum accuracy. A rise in power supply temperature could be a sign of loose connections or some other malfunction.

OPEN THE TEMPERATURE WINDOW

- [Access your G4K Unit](#) via the Web Interface → select Monitoring → Temperature:

MONITORING	ENERGY	POWER QUALITY
Summary		V & I harmonics
Voltage & Current		P & Q harmonics
Average		Spectrum
Power		Harmonics Table
Temperature		V/I Min/Max Harmonics
Phasors		P/Q Min/Max Harmonics
Waveforms		
Voltage Flickering		
Pinst Waveform		
Min/Max Flickering		

- The Temperature Window will now open:

RO ■ MONITORING » TEMPERATURE			
Reset All Min/Max			
Internal Temperature			
Internal _{avg}	Internal _{min}	Internal _{max}	
60.60 °C	59.05 °C	62.45 °C	
External Temperature			
External _{avg}	External _{min}	External _{max}	
27.27 °C	31.59 °C	55.88 °C	
PSU Temperature			
PSU _{avg}	PSU _{min}	PSU _{max}	
63.34 °C	61.66 °C	65.31 °C	

The table outlines the sections' Parameters including Definition:

PARAMETER	DEFINITION
Internal Temperature	The average, minimum, and maximum internal temperature of the DSP Module
External Temperature	Utilizing a PT100 Thermometer , average, minimum, and maximum outside temperatures are monitored. The temperatures measured every network cycle and averaged over 10 cycles. The data is stored in the PQZIP files every 10 minutes.
PSU Temperature	The average minimum and maximum temperature of the Power Supply Module
Reset All Min/Max	Reset all Min/Max measurements of your G4K Unit

SEE ALSO

- [Monitoring Real-Time Data](#)
- [Voltage & Current Measurements](#)
- [Average](#)
- [Power](#)
- [Phasors](#)
- [Waveforms](#)
- [Voltage Flickering](#)
- [Pinst Waveform](#)
- [Minimum / Maximum Flickering](#)
- [Voltage & Current Harmonics](#)
- [P & Q Harmonics](#)
- [Spectrum](#)
- [Harmonics Table](#)
- [Voltage & Current, Min & Max Harmonics Table](#)
- [PQ Min & Maximum Harmonics](#)

Phasors

A Phasor is a vector representation of the Voltages & Currents in the system. The Phasor Window of the BLACKBOX Web Interface represents both Wye and Delta Voltage Configurations in a Phasor format. Therefore, the Phasors are a vector representation of the First Harmonic.

NOTE NOTE NOTE

- In order to display the Phasor graph, ensure that you install the ActiveX plug-in from Gigasoft (downloadable either from [Elspec's Website's Support Section](#) or alternatively can be installed directly from our [BLACKBOX C D](#)). You will receive the following error message if the program is not installed:

**Charting plugin initialization failed!
Browser security prevents automatic
installation of ActiveX control**

- For Internet Explorer 8/9 Users: Once you have installed Gigasoft, ensure that the Internet Explorer is running in Compatibility View:



OPEN THE PHASORS WINDOW

- [Access your G4K Unit](#) via the Web Interface → select Monitoring → Phasors:

MONITORING	ENERGY	POWER QUALITY
Summary		V & I harmonics
Voltage & Current		P & Q harmonics
Average		Spectrum
Power		Harmonics Table
Temperature		V/I Min/Max Harmonics
Phasors		P/Q Min/Max Harmonics
Waveforms		
Voltage Flickering		
Pinst Waveform		
Min/Max Flickering		

- The Phasor Window will now open:

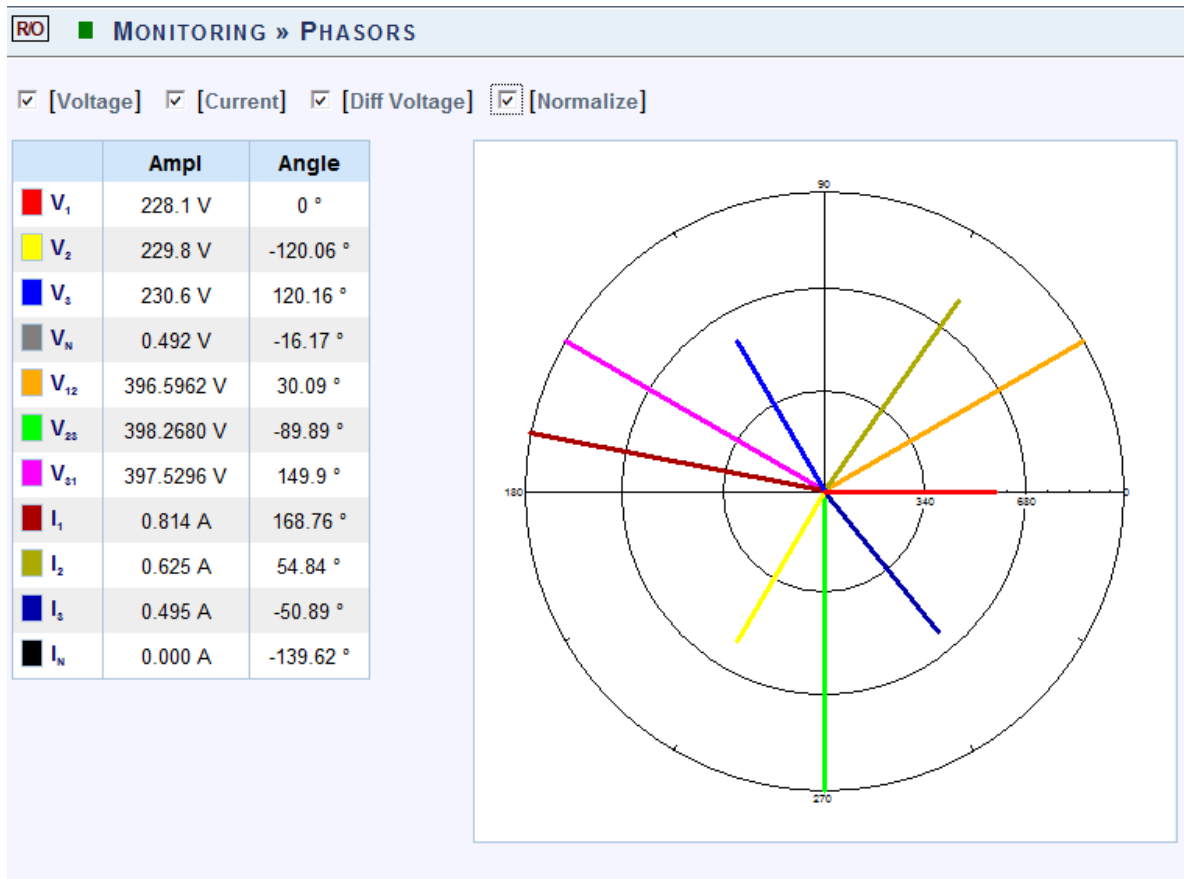

The table outlines the sections' Parameter options (for your selection) including their Definition:

PARAMETER	DEFINITION
Voltage	Displays Voltage Phase to Neutral Phasor (only present with WYE 4 Wire configuration)
Current	Displays Phase Current
Diff Voltage	Displays the Phase to Neutral Voltages Phasor
Diff Current	Displays the Phase to Phase Current (only present with Delta 3 Wire configuration)
Normalize	Displays the all vector as part of the largest vector
Ampl	The Amplitude of each Phasor
Angle	V1 /V12 is at 0°, all other vectors are in relation to V1 /V12

CHART OPTIONS

- Right-click on the chart to access various options & capabilities for the chart:

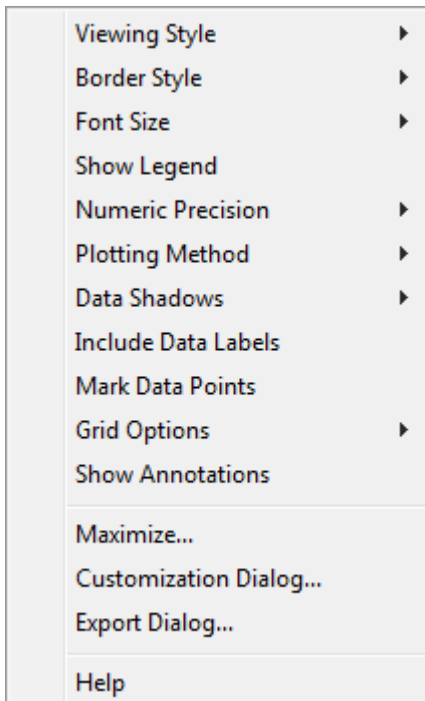

- You may use the following chart options & capabilities:
 - **Viewing Style:** Different styling options Color / Monochrome (B&W) with/without Symbols / Bitmap etc. By selecting the option you can view on screen the different styles available to you
 - **Border Style:** No Border, Thin Line, Shadow / Inset
 - **Font Size:** Large / Medium / Small
 - **Show Legend:** Display / Not display Legend
 - **Plotting Method:** From Line / Point / Point & Line
 - **Data Shadows:** Off / Shadow / 3D
 - **Include Data Labels:** Include / Exclude Numeric Data Labels
 - **Mark Data Points:** Mark/Unmark Data Points
 - **Grid Options:** Extend Radius Tick Marks, Both Degrees & Radius, Degrees, Radius, Hid Grid Lines, Thin Grid Lines, Thick Grid Lines, Dotted Grid Lines, Dashed Grid Lines & One Pixel Grid Lines
 - **Maximize:** Min / Max the Phasor Graph Only

- Customization Dialog - Various General Graph Customization Options (all options):

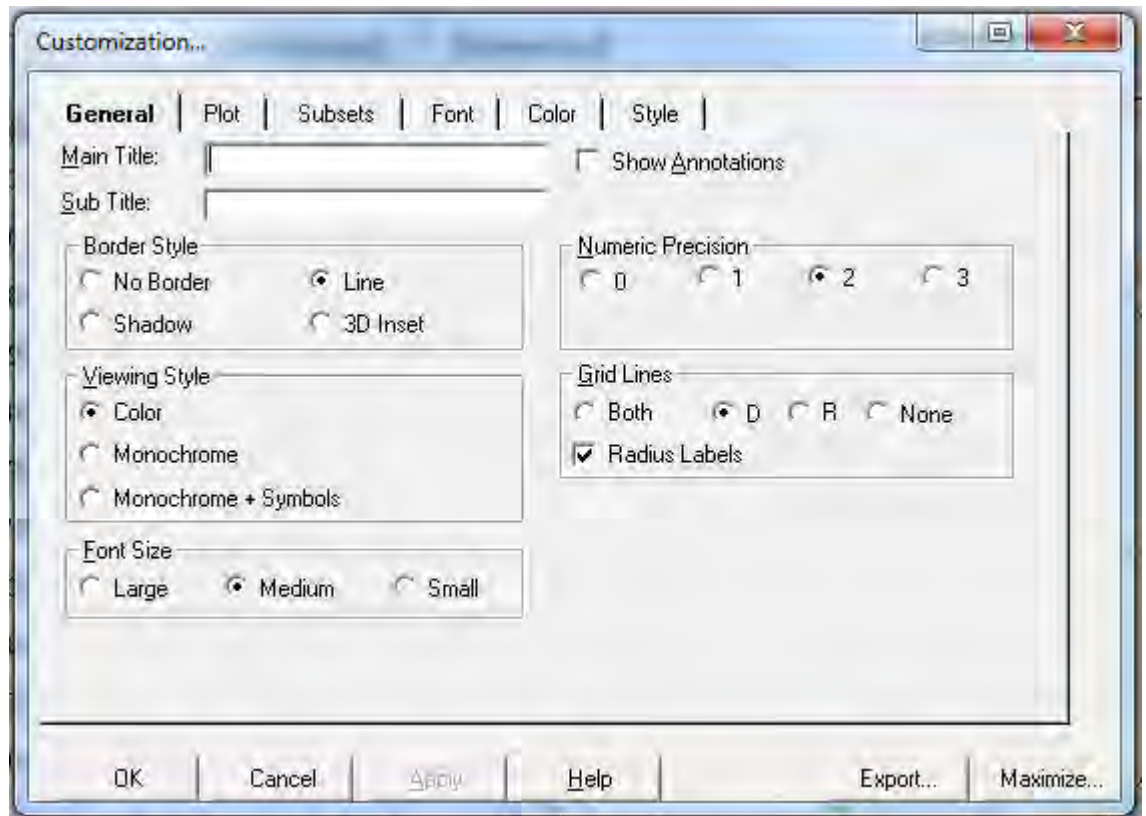

- Export Dialog - Various Export Options:

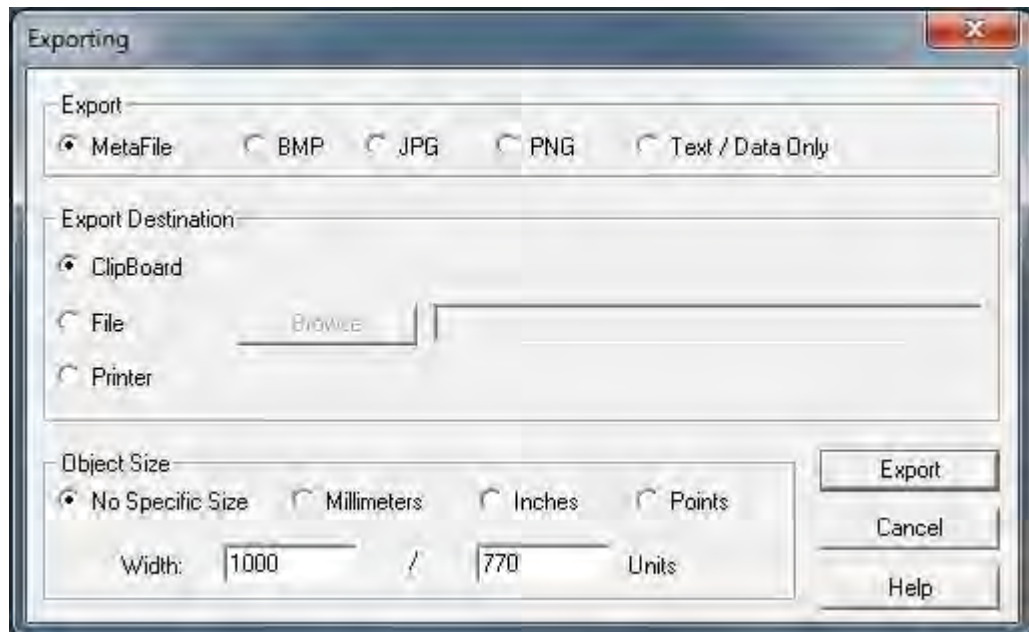

SEE ALSO

- [Monitoring Real-Time Data](#)
- [Voltage & Current Measurements](#)
- [Average](#)
- [Power](#)
- [Temperature](#)
- [Waveforms](#)
- [Voltage Flickering](#)
- [Pinst Waveform](#)
- [Minimum / Maximum Flickering](#)
- [Voltage & Current Harmonics](#)
- [P & Q Harmonics](#)
- [Spectrum](#)
- [Harmonics Table](#)
- [Voltage & Current, Min & Max Harmonics Table](#)
- [PQ Min & Maximum Harmonics](#)

Waveforms

The Waveform page displays the actual Voltage & Current waveforms monitored by your G4K BLACKBOX Unit.

NOTE NOTE NOTE

- In order to display the Phasor graph, ensure that you install the ActiveX plug-in from Gigasoft (downloadable either from [Elspec's Website's Support Section](#) or alternatively can be installed directly from your [BLACKBOX C D](#)). You will receive the following error message if the program is not installed:

**Charting plugin initialization failed!
Browser security prevents automatic
installation of ActiveX control**

- For Internet Explorer 8/9 Users: Once you have installed Gigasoft, ensure that the Internet Explorer is running in Compatibility View:



OPEN THE WAVEFORMS WINDOW

- [Access your G4K Unit](#) via the Web Interface → select Monitoring → Waveforms:

MONITORING	ENERGY	POWER QUALITY
Summary		V & I harmonics
Voltage & Current		P & Q harmonics
Average		Spectrum
Power		Harmonics Table
Temperature		V/I Min/Max Harmonics
Phasors		P/Q Min/Max Harmonics
<u>Waveforms</u>		
Voltage Flickering		
Pinst Waveform		
Min/Max Flickering		

- The Waveforms Window will now open:

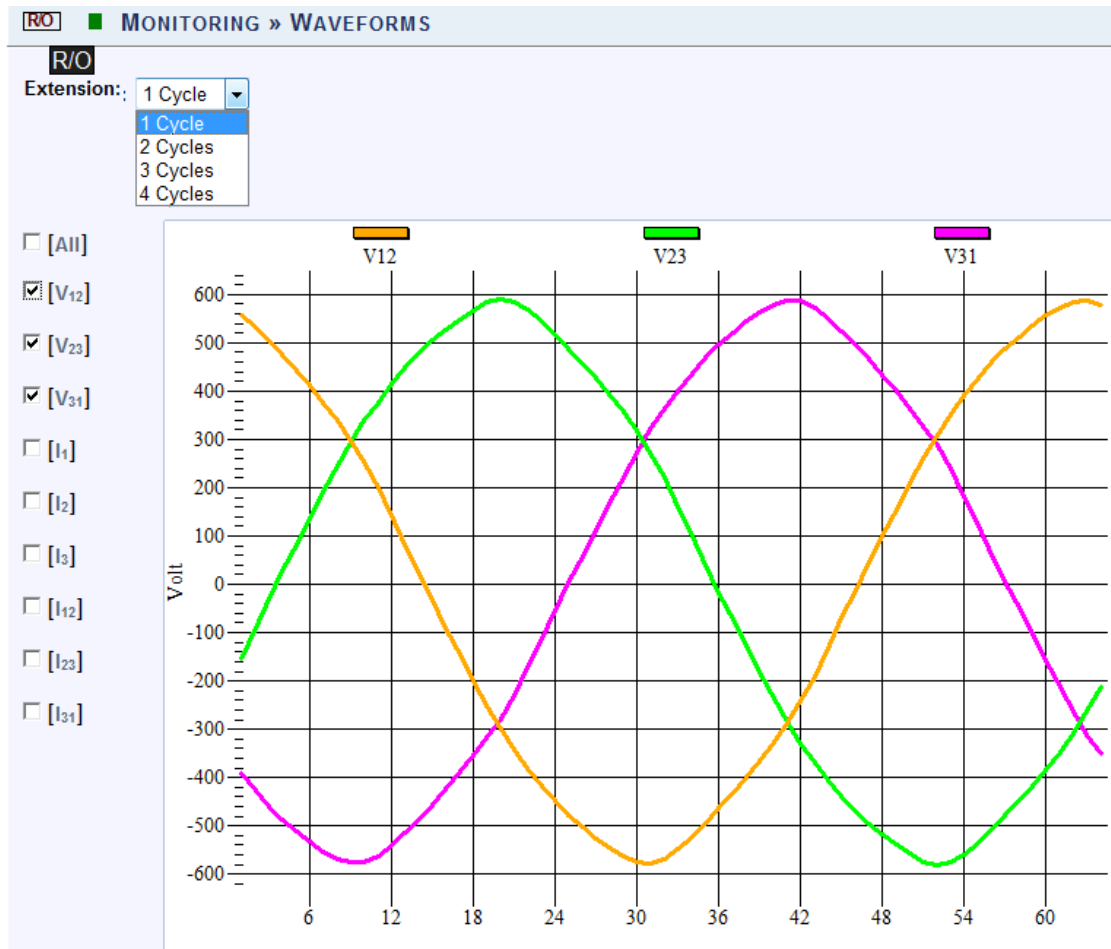

The table outlines the sections' Parameter options (for your selection) including their Definition:

PARAMETER	DEFINITION
Cycle	Cycle Selection (1-4 Cycles)
All	Checking the "All graphs" box will automatically select all the boxes below
Voltage & Current	Depending on your power configuration, you can view all combinations of phase to phase and phase to line voltage and current combinations by making selections in the appropriate check boxes

CHART OPTIONS

- By right-clicking on the chart you have various chart options & capabilities available to you:

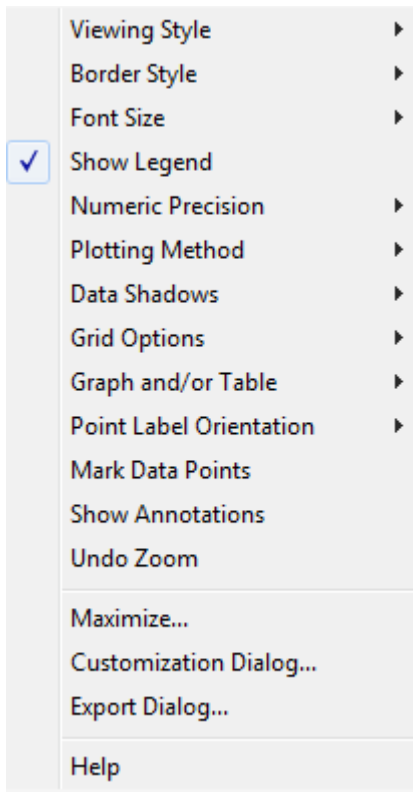

- **Viewing Style:** Different styling options Color / Monochrome (B&W) with/without Symbols / Bitmap etc. By selecting the option you can view on screen the different styles available to you
- **Border Style:** No Border, Thin Line, Shadow / Inset
- **Font Size:** Large / Medium / Small
- **Display / Not display Legend**
- **Numeric Precision:** No up to 3 Decimals
- **Plotting Method:** From Line / Bar / Point / Area / Spline / Combinations
- **Data Shadows:** Off / Shadow / 3D
- **Grid Options:** Various grid options ranging from dots / lines / different axis etc.

- Graph & Table: Display either the graph / table / both:

V1	-0.610	0.316	0.487	-0.659	-0.220	0.512	-0.413	-1.240	-0.145	0.245
V2	-0.514	0.270	0.245	-0.586	-0.219	0.391	-0.075	-0.516	0.097	0.195
V3	-0.927	0.439	0.463	-0.903	-0.367	0.756	-0.243	-0.876	0.465	0.318
VN	0.122	-0.049	-0.391	-0.293	-0.513	-0.318	-0.293	-0.220	0.024	0.073
V12	0.244	0.049	0.098	-0.047	-0.338	0.001	-0.000	-0.266	-0.243	0.340
V23	0.317	0.365	-0.293	-0.050	0.509	-0.123	-0.146	0.388	0.219	-0.365
V31	-0.561	-0.415	0.195	0.097	-0.172	0.122	0.146	-0.123	0.024	0.025
I1	3.906	0.244	-1.465	0.488	-0.244	0.488	1.221	0.977	-0.977	0.488
I2	3.418		-1.709	0.244	-0.488	0.977	0.732	0.732	-1.465	0.244
I3	3.174	0.488	-1.221	0.488		0.488	0.244	0.488	-1.221	-1.221
IN	0.732	-0.244	-1.953	-1.465	-2.197	-0.488		-0.977	-1.465	-0.488

- Point Label Orientation: Auto / Vertical / Horizontal / Slanted
- Mark Data Points: Displays data points on graph
- Show Annotations: Displays annotations data descriptions
- Zoom / Undo Zoom - Zoom in /out on your graph:
 - From the main Waveform window, select an area to zoom in. Left-click and drag the mouse to define the area:

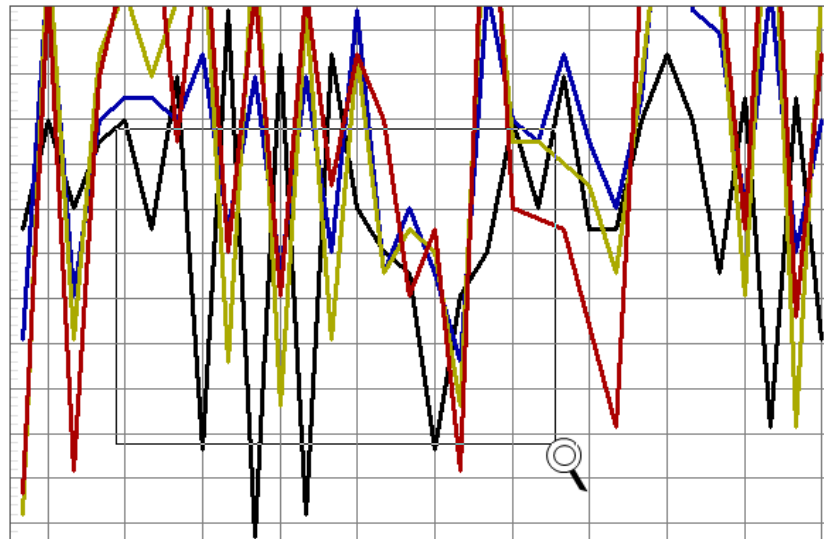

- The enlarged area will now appear in the window
 - Zoom out by right/click ➡ & select Zoom out
- Maximize: Maximize / Minimize graph

- Customization Dialog - Various General Graph Customization Options (all options apart from zooming above):

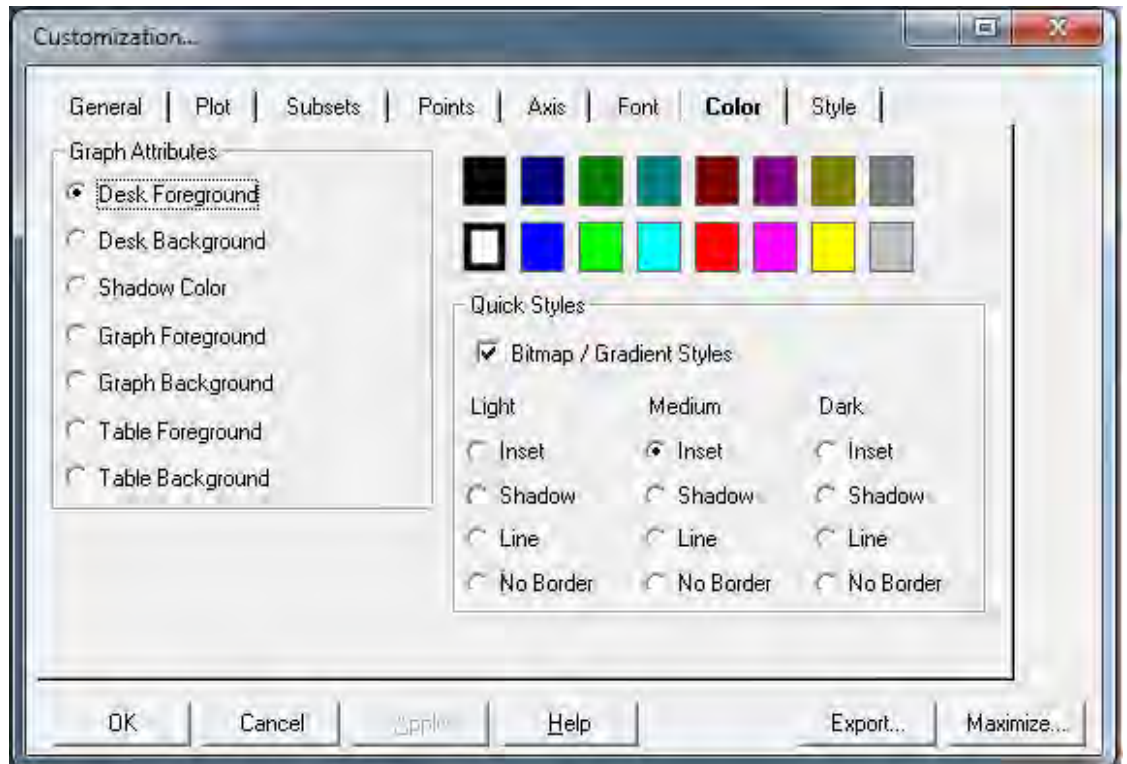

- Export Dialog - Various Export Options:

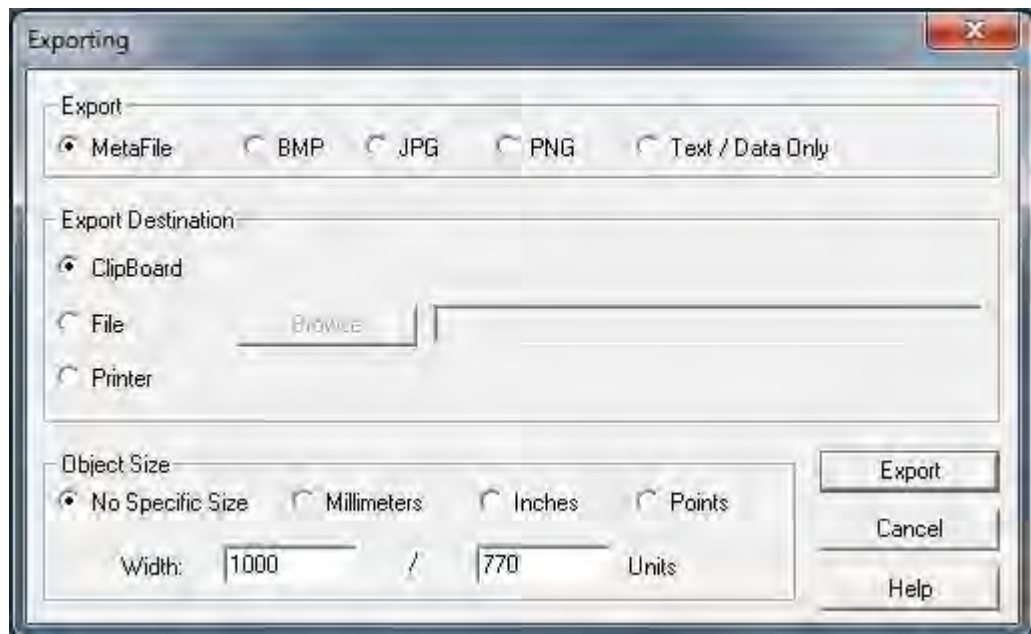

SEE ALSO

- [Monitoring Real-Time Data](#)
- [Voltage & Current Measurements](#)
- [Average](#)
- [Power](#)
- [Temperature](#)
- [Phasors](#)
- [Voltage Flickering](#)
- [Pinst Waveform](#)
- [Minimum / Maximum Flickering](#)
- [Voltage & Current Harmonics](#)
- [P & Q Harmonics](#)
- [Spectrum](#)
- [Harmonics Table](#)
- [Voltage & Current, Min & Max Harmonics Table](#)
- [PQ Min & Maximum Harmonics](#)

Voltage Flickering

Displays the short & long term Voltage Flickering to a very close approximation of the EN50160 values.

OPEN THE VOLTAGE FLICKERING WINDOW

- Access your [G4K Unit](#) via the Web Interface → select Monitoring → Voltage Flickering:

MONITORING	ENERGY	POWER QUALITY
Summary	V & I harmonics	
Voltage & Current	P & Q harmonics	
Average	Spectrum	
Power	Harmonics Table	
Temperature	V/I Min/Max Harmonics	
Phasors	P/Q Min/Max Harmonics	
Waveforms		
Voltage Flickering		
Pinst Waveform		
Min/Max Flickering		

- The Voltage Flickering Window will now open:

MONITORING » VOLTAGE FLICKERING								
Reset Flickering								
Voltage Flickering								
	PST INST	PSST 10 Sec.	PST 10 Min.	SPLT 1 Hour	PLT 2 Hour	LPLT 10 Hour	LPLT 1 Day	LPLT 7 Day
V ₁₂	0.315702	0.292279	0.291420	0.273509	0.270095	0.305009	0.299435	0.410882
V ₂₃	0.347245	0.299165	0.289953	0.270103	0.268835	0.304742	0.297192	0.481015
V ₃₁	0.332792	0.297885	0.294528	0.273342	0.270989	0.306527	0.300819	0.465656
	10 Min.				2 Hours			
Timestamp	11/09/2010 11:50:00				11/09/2010 10:00:00			
Flag	Not flagged				Not flagged			

The table outlines the sections' Parameter options (for your selection) including their Definition:

PARAMETER	DEFINITION
PST INST	Instantaneous flicker evaluation. Output of Block 5 of the Flickermeter in Accordance with IEC61000-4-15 Edition 2
PSST 10 Sec.	An Elspec measurement designed to get quicker results regarding Flicker evaluation. This measurement reaches a very close approximation of the EN50160 values, but in a fraction of the time. The PSST is calculated the same as PST but averaged over 10 seconds. This Elspec defined value is valuable in that it enables faster assessment of the flicker. Elspec PSST converges to a real value within 3 min from a drastic flicker change, or immediately for periodic steady state flicker
PST	$P_{ST} = \sqrt{0.0314P_{0.1} + 0.0525P_{1s} + 0.0657P_{3s} + 0.28P_{10s} + 0.08P_{50s}}$ <p>Where the Percentiles $P_{0.1}$, P_1, P_3, P_{10}, P_{50} are the Flicker Levels Exceeded for 0.1, 1, 3, 10 & 50% of the Time During The Observation Period. The Suffix "s" in the Formula Indicates that the Smoothed Value Should be Used. The Smoothed Values are Obtained Using the Following Formulas:</p> <p>$P(1s) = (P(.7) + P(1) + P(1.5))/3$</p> <p>$P(3s) = (P(2.2) + P(3) + P(4))/3$</p> <p>$P(10s) = (P(6) + P(8) + P(10) + P(13) + P(17))/5$</p> <p>$P(50s) = (P(30) + P(50) + P(80))/3$</p>
PST 10 Min	Short term flicker evaluation. P_{ST} is a value measured over 10 minutes that characterizes the likelihood that the voltage fluctuations would result in perceptible light flicker. A value of 1.0 is designed to represent that 50% of people would perceive flicker in a 60 watt incandescent bulb.
PLT	$P_{LT} = \sqrt[3]{\frac{\sum_{i=1}^N P_{ST_i}^3}{N}}$ <p>Where P_{ST_i} ($i = 1, 2, 3, \dots$) are the Consecutive Readings of the P_{ST}</p>

PARAMETER	DEFINITION
SPLT 1 Hour	<p>An Elspec measurement designed to get quicker results regarding Flicker evaluation. This measurement reaches a very close approximation of the EN 50160 values, but in a fraction of the time.</p> <p>The SPLT is calculated the same as PLT but averaged over 1 hour. This Elspec defined value is valuable in that it enables faster assessment of the flicker</p>
PLT 2 Hour	The Long-Term PLT is Derived From the Short-Term Values Over 12 Short-Term Values of 10 Minutes Each Over a Period of 2 hours
LPLT 10 Hour	<p>An Elspec measurement designed to give better results regarding Flicker evaluation by using a longer averaging time. The LP_{LT} is calculated the same as P_{LT} but averaged over 10 hours to allow a quicker "long term" average</p>
LPLT 7 Day	<p>An Elspec measurement designed to give better results regarding Flicker evaluation by using a longer averaging time.</p> <p>The LP_{LT} is calculated the same as P_{LT} but averaged over 7 days, as per EN50160 parts 4-15</p>
Reset Flickering	Reset all Flickering measurements of your G4K Unit

SEE ALSO

- [Monitoring Real-Time Data](#)
- [Voltage & Current Measurements](#)
- [Average](#)
- [Power](#)
- [Temperature](#)
- [Phasors](#)
- [Waveforms](#)
- [Pinst Waveform](#)
- [Minimum / Maximum Flickering](#)
- [Voltage & Current Harmonics](#)
- [P & Q Harmonics](#)
- [Spectrum](#)
- [Harmonics Table](#)
- [Voltage & Current, Min & Max Harmonics Table](#)
- [PQ Min & Maximum Harmonics](#)

Pinst Waveform

Pinst is instantaneous flicker sensation that the G4K calculates for every selected channel.

OPEN THE PINST WAVEFORM WINDOW

- [Access your G4K Unit](#) via the Web Interface → select Monitoring → Pinst Waveforms:

MONITORING	ENERGY	POWER QUALITY
Summary		V & I harmonics
Voltage & Current		P & Q harmonics
Average		Spectrum
Power		Harmonics Table
Temperature		V/I Min/Max Harmonics
Phasors		P/Q Min/Max Harmonics
Waveforms		
Voltage Flickering		
Pinst Waveform		
Min/Max Flickering		

- The Pinst Waveforms Window will now open:

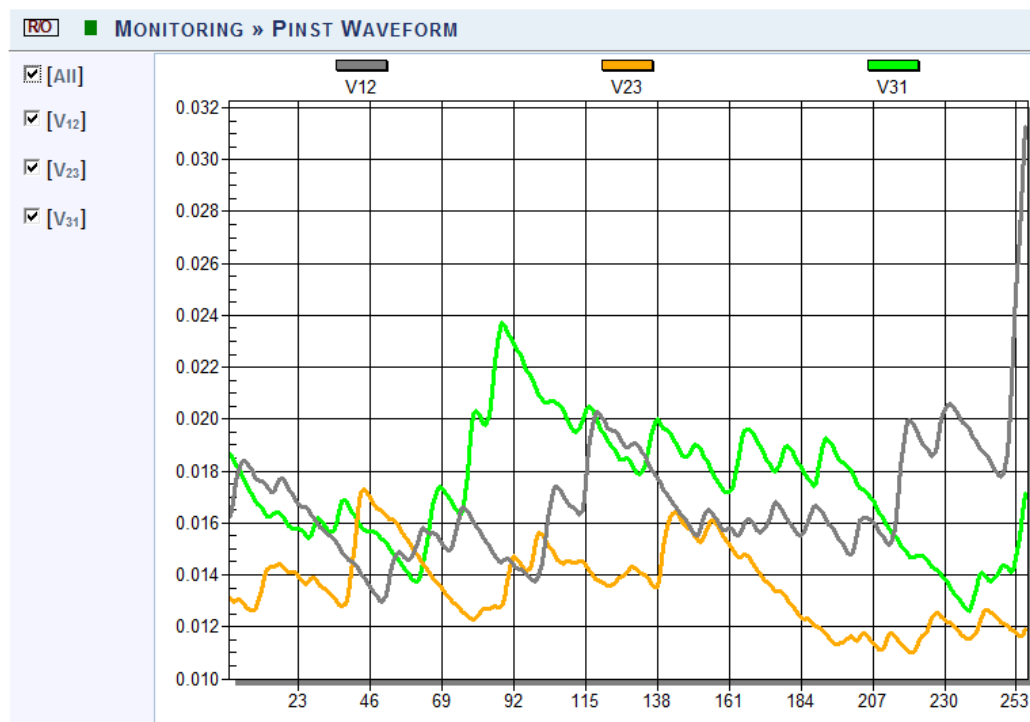

The table outlines the sections' Parameter options (for your selection) including their Definition:

PARAMETER	DEFINITION
All	Checking the "All graphs" box will automatically select all the boxes below
Voltage Channels	Select the applicable channel for Flickering Waveform display.

SEE ALSO

- [Monitoring Real-Time Data](#)
- [Voltage & Current Measurements](#)
- [Average](#)
- [Power](#)
- [Temperature](#)
- [Phasors](#)
- [Waveforms](#)
- [Voltage Flickering](#)
- [Minimum / Maximum Flickering](#)
- [Voltage & Current Harmonics](#)
- [P & Q Harmonics](#)
- [Spectrum](#)
- [Harmonics Table](#)
- [Voltage & Current, Min & Max Harmonics Table](#)
- [PQ Min & Maximum Harmonics](#)

Minimum / Maximum Flickering

Displays the minimum & maximum short & long term Voltage Flickering vales to a very close approximation of the EN50160 values.

OPEN THE MIN/MAX FLICKERING WINDOW

- [Access your G4K Unit](#) via the Web Interface → select Monitoring
→ Min/Max Flickering:

MONITORING	ENERGY	POWER QUALITY
Summary	V & I harmonics	
Voltage & Current	P & Q harmonics	
Average	Spectrum	
Power	Harmonics Table	
Temperature	V/I Min/Max Harmonics	
Phasors	P/Q Min/Max Harmonics	
Waveforms		
Voltage Flickering		
Pinst Waveform		
<u>Min/Max Flickering</u>		

- The Min/Max Flickering Window will now open:

MONITORING » MIN/MAX FLICKERING									
Reset All Min/Max									
Min/Max Flickering									
		PSST 2 Sec.	PSST 10 Sec.	PST 10 Min.	SPLT 1 Hour	PLT 2 Hour	LPLT 10 Hour	LPLT 1 Day	LPLT 7 Day
V ₁₂	Min.	N/A	N/A	N/A	N/A	N/A	N/A	N/A	N/A
	Max.	71637.10	23127.63	124.9797	1.194570	0.950628	0.580950	0.478969	0.410882
V ₂₃	Min.	N/A	N/A	N/A	N/A	N/A	N/A	N/A	N/A
	Max.	70519.79	22767.93	124.8582	1.407181	1.182908	0.780778	0.654229	0.481015
V ₃₁	Min.	N/A	N/A	N/A	N/A	N/A	N/A	N/A	N/A
	Max.	71572.71	23106.75	125.2780	1.350298	1.109859	0.752893	0.624114	0.465656

The table outlines the sections' Parameter options (for your selection) including their Definition:

PARAMETER	DEFINITION
PST INST	Instantaneous flicker evaluation. Output of Block 5 of the Flickermeter in Accordance with IEC61000-4-15 Edition 2
PSST 10 Sec.	An EISpec measurement designed to get quicker results regarding Flicker evaluation. This measurement reaches a very close approximation of the EN50160 values, but in a fraction of the time. The PSST is calculated the same as PST but averaged over 10 seconds. This EISpec defined value is valuable in that it enables faster assessment of the flicker. EISpec PSST converges to a real value within 3 min from a drastic flicker change, or immediately for periodic steady state flicker
PST	$P_{ST} = \sqrt{0.0314P_{0.1} + 0.0525P_{1s} + 0.0657P_{3s} + 0.28P_{10s} + 0.08P_{50s}}$ <p>Where the Percentiles $P_{0.1}$, P_1, P_3, P_{10}, P_{50} are the Flicker Levels Exceeded for 0.1, 1, 3, 10 & 50% of the Time During The Observation Period. The Suffix "s" in the Formula Indicates that the Smoothed Value Should be Used. The Smoothed Values are Obtained Using the Following Formulas:</p> <p>$P(1s) = (P(.7) + P(1) + P(1.5))/3$</p> <p>$P(3s) = (P(2.2) + P(3) + P(4))/3$</p> <p>$P(10s) = (P(6) + P(8) + P(10) + P(13) + P(17))/5$</p> <p>$P(50s) = (P(30) + P(50) + P(80))/3$</p>
PST 10 Min	Short term flicker evaluation. P_{ST} is a value measured over 10 minutes that characterizes the likelihood that the voltage fluctuations would result in perceptible light flicker. A value of 1.0 is designed to represent that 50% of people would perceive flicker in a 60 watt incandescent bulb.
PLT	$P_{LT} = \sqrt{\frac{\sum_{i=1}^N P_{sti}^3}{N}}$ <p>Where P_{sti} ($i = 1, 2, 3, \dots$) are Consecutive Readings of the Short-Term Severity P_{ST}</p>

PARAMETER	DEFINITION
SPLT 1 Hour	An E lspec m easurement d esigned t o g et quicker r esults r egarding Flicker ev aluation. T his m easurement reaches a v ery cl ose approximation of the EN50160 values, but in a fraction of the time. The SPLT is calculated t he same as PLT but averaged over 1 hour. This E lspec d efined value is v aluable i n t hat it enables f aster assessment of the flicker
PLT 2 Hour	The Long-Term PLT is Derived From the Short-Term Values Over 12 Short-Term Values of 10 Minutes Each Over a Period of 2 hours
LPLT 10 Hour	An E lspec m easurement d esigned t o g ive b etter r esults r egarding Flicker ev aluation b y u sing a l onger av eraging t ime. T he L P _{LT} is calculated t he same as P _{LT} but averaged over 10 hours t o allow a quicker "long term" average
LPLT 1 Day	An E lspec m easurement d esigned t o g ive b etter r esults r egarding Flicker evaluation by using a longer averaging time. The LP _{LT} is calculated the same as P _{LT} but averaged over 1 day
LPLT 7 Day	An E lspec m easurement d esigned t o g ive b etter r esults r egarding Flicker evaluation by using a longer averaging time. The LP _{LT} is calculated the same as P _{LT} but averaged over 7 days, as per EN50160 parts 4-15
	Reset all Flickering measurements of your G4K Unit

SEE ALSO

- [Monitoring Real-Time Data](#)
- [Voltage & Current Measurements](#)
- [Average](#)
- [Power](#)
- [Temperature](#)
- [Phasors](#)
- [Waveforms](#)
- [Voltage Flickering](#)
- [Pinst Waveform](#)
- [Minimum / Maximum Flickering](#)
- [Voltage & Current Harmonics](#)
- [P & Q Harmonics](#)
- [Spectrum](#)
- [Harmonics Table](#)
- [Voltage & Current, Min & Max Harmonics Table](#)
- [PQ Min & Maximum Harmonics](#)

Voltage & Current Harmonics

This window opens the Spectrum of Voltage & Current Harmonics measured by your G4K Unit. The graph is able to display of up to 40 Harmonics.

OPEN THE V&I HARMONICS WINDOW

- [Access your G4K Unit](#) via the Web Interface → select Monitoring → V&I Harmonics:

MONITORING	ENERGY	POWER QUALITY
Summary		<u>V & I harmonics</u>
Voltage & Current		P & Q harmonics
Average		Spectrum
Power		Harmonics Table
Temperature		V/I Min/Max Harmonics
Phasors		P/Q Min/Max Harmonics
Waveforms		
Voltage Flickering		
Pinst Waveform		
Min/Max Flickering		

- The V&I Harmonics Window will now open:

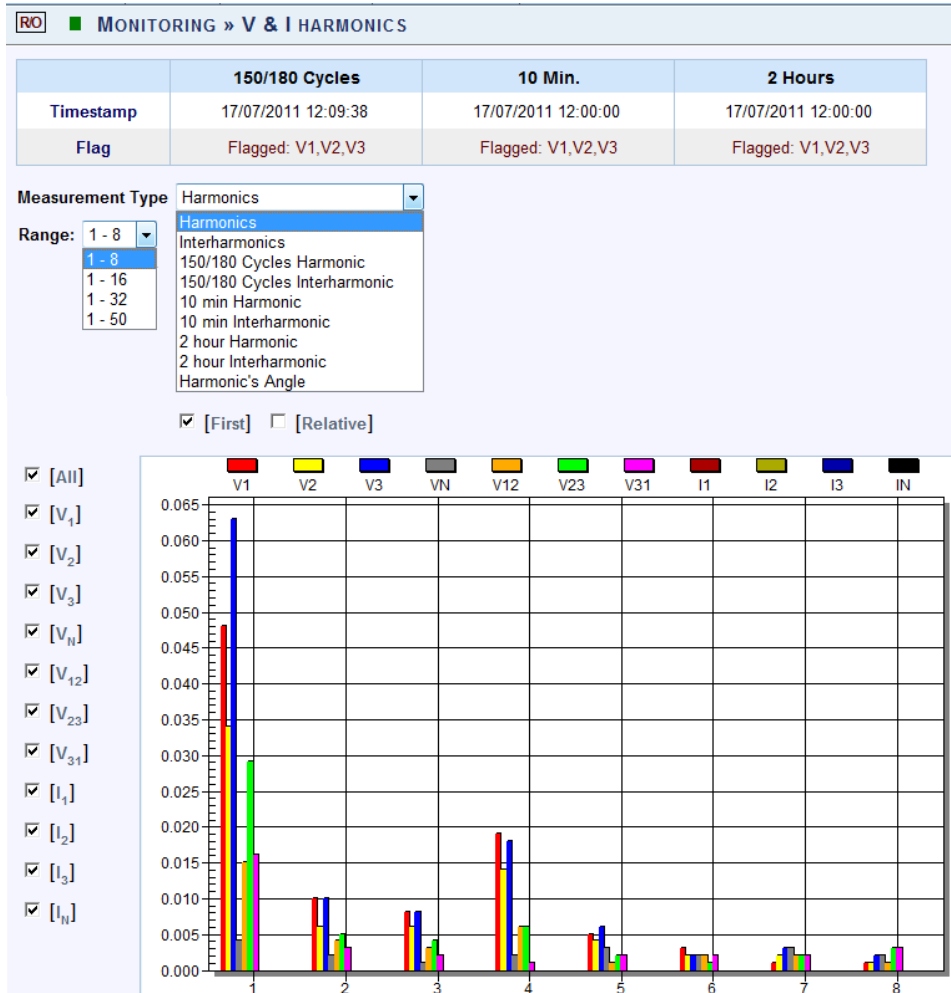

The table outlines the sections' Parameter options (for your selection) including their Definition:

PARAMETER	DEFINITION
Timestamp	Indicates the timestamps of the last averaging intervals
Flag	Indicates whether or not the last interval is valid according to the set standard
MEASUREMENT TYPE	
Harmonics	Real time (10/12 cycles) calculation of subgroup harmonics, in accordance with IEC61000-4-7. $G_{sg,n}^2 = \sum_{i=1}^1 C_{k+i}^2$
Interharmonics	Real time (10/12 cycles) calculation of inter subgroup harmonics, in accordance with IEC61000-4-7.
150/180 Cycles Harmonic	150/180 Cycle averaging of the subgroup harmonics

PARAMETER	DEFINITION
150/180 Cycles Interharmonic	150/180 Cycle averaging of the inter sub group harmonics
10 Min Harmonic	10 Minutes averaging of the sub group harmonics
10 Min Interharmonic	10 Minutes averaging of the inter sub group harmonics
2 Hour Harmonic	2 Hours averaging of the 10 minutes averaging of the sub group harmonics
2 Hour Interharmonic	2 Hours averaging of the 10 minutes averaging of the inter sub group harmonics
Harmonic's Angle	The angle of each harmonic based on the real time value
RANGE	
1-8	Select the number of harmonics to be displayed 1-8
1-16	Select the number of harmonics to be displayed 1-16
1-32	Select the number of harmonics to be displayed 1-32
1-50	Select the number of harmonics to be displayed 1-50
OPTIONS	
First	Check/Uncheck the checkbox in order to display/not display the first harmonic
Relative	Check/Uncheck the checkbox in order to display/not display the harmonics relative to the first harmonic (Whereas the first harmonic is 100, and the other harmonic values as part of the harmonic 100)
All	Checking the "All" will display all the channels
Voltage & Current	Select the applicable Voltage / Current channel to be displayed

CHART OPTIONS

- By right-clicking on the chart you have various chart options & capabilities available to you:

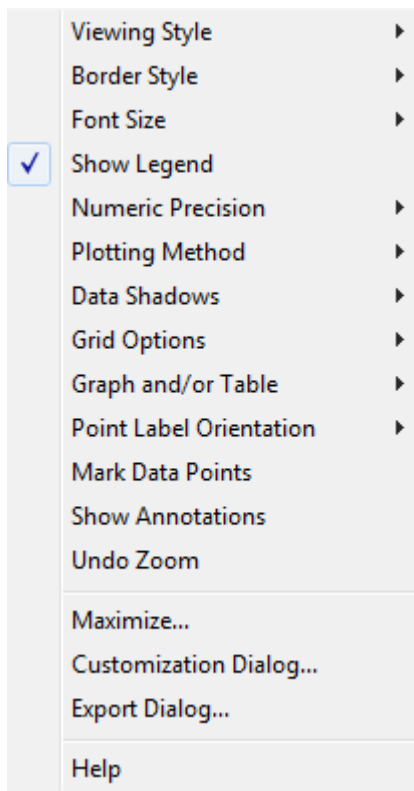

- Viewing Style:** Different styling options Color / Monochrome (B&W) with/without Symbols / Bitmap etc. By selecting the option you can view on screen the different styles available to you
- Border Style:** No Border, Thin Line, Shadow / Inset
- Font Size:** Large / Medium / Small
- Display / Not display Legend**
- Numeric Precision:** No up to 3 Decimals
- Plotting Method:** From Line / Bar / Point / Area / Spline / Combinations
- Data Shadows:** Off / Shadow / 3D
- Grid Options:** Various grid options ranging from dots / lines / different axis etc.
- Graph & Table:** Display either the graph / table / both:

	4	5	6
V1	0.016	0.003	0.005
V2	0.013	0.003	0.003
V3	0.017	0.003	0.005
VN	0.002	0.003	0.003
V12	0.005	0.003	0.003
V23	0.006	0.002	0.003
V31	0.003	0.003	0.002

- Point Label Orientation:** Auto / Vertical / Horizontal / Slanted
- Mark Data Points:** Displays data points on graph

- Zoom / Undo Zoom - Zoom in /out on your graph:
 - From the main Waveform window, select an area to zoom in. Left-click and drag the mouse to define the area:

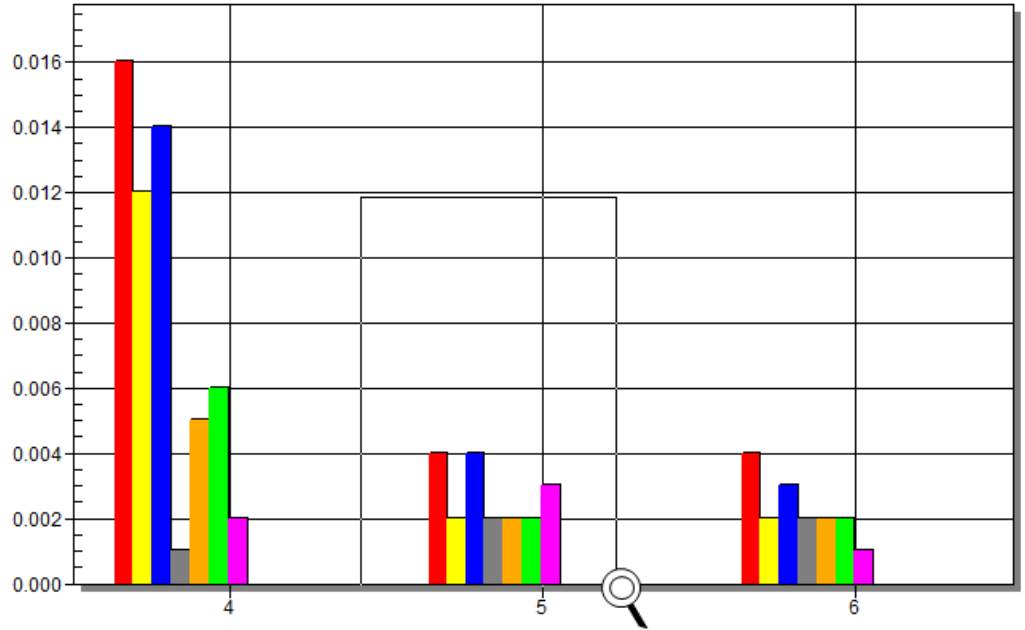

- The enlarged area will now appear in the window
 - Zoom out by right/click ➡ & select Zoom out
- Maximize: Maximize / Minimize graph
- Customization Dialog - Various General Graph Customization Options (all options apart from zooming above):

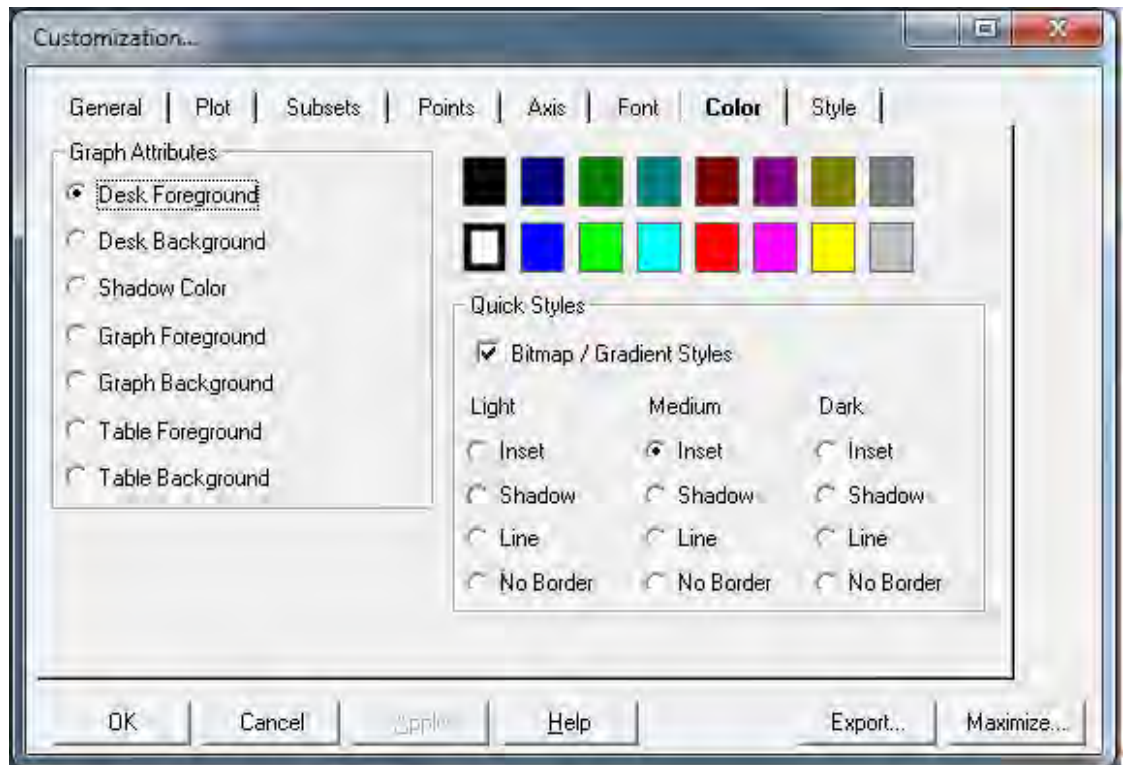

- Export Dialog - Various Export Options:

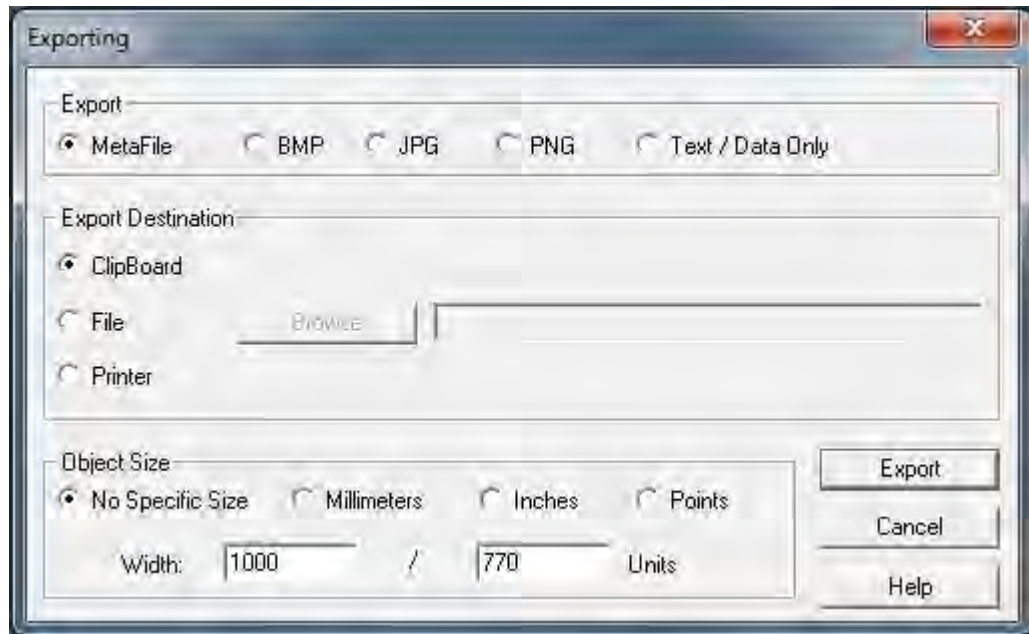

SEE ALSO

- [Monitoring Real-Time Data](#)
- [Voltage & Current Measurements](#)
- [Average](#)
- [Power](#)
- [Temperature](#)
- [Phasors](#)
- [Waveforms](#)
- [Voltage Flickering](#)
- [Pinst Waveform](#)
- [Minimum / Maximum Flickering](#)
- [P & Q Harmonics](#)
- [Spectrum](#)
- [Harmonics Table](#)
- [Voltage & Current, Min & Max Harmonics Table](#)
- [PQ Min & Maximum Harmonics](#)

P & Q Harmonics

This window opens the Active & Reactive Harmonic Powers measured by your G4K Unit.

OPEN THE P&Q HARMONICS WINDOW

- [Access your G4K Unit](#) via the Web Interface → select Monitoring → P&Q Harmonics:

MONITORING	ENERGY	POWER QUALITY
Summary	V & I harmonics	
Voltage & Current	<u>P & Q harmonics</u>	
Average	Spectrum	
Power	Harmonics Table	
Temperature	V/I Min/Max Harmonics	
Phasors	P/Q Min/Max Harmonics	
Waveforms		
Voltage Flickering		
Pinst Waveform		
Min/Max Flickering		

- The P&Q Harmonics Window will now open:

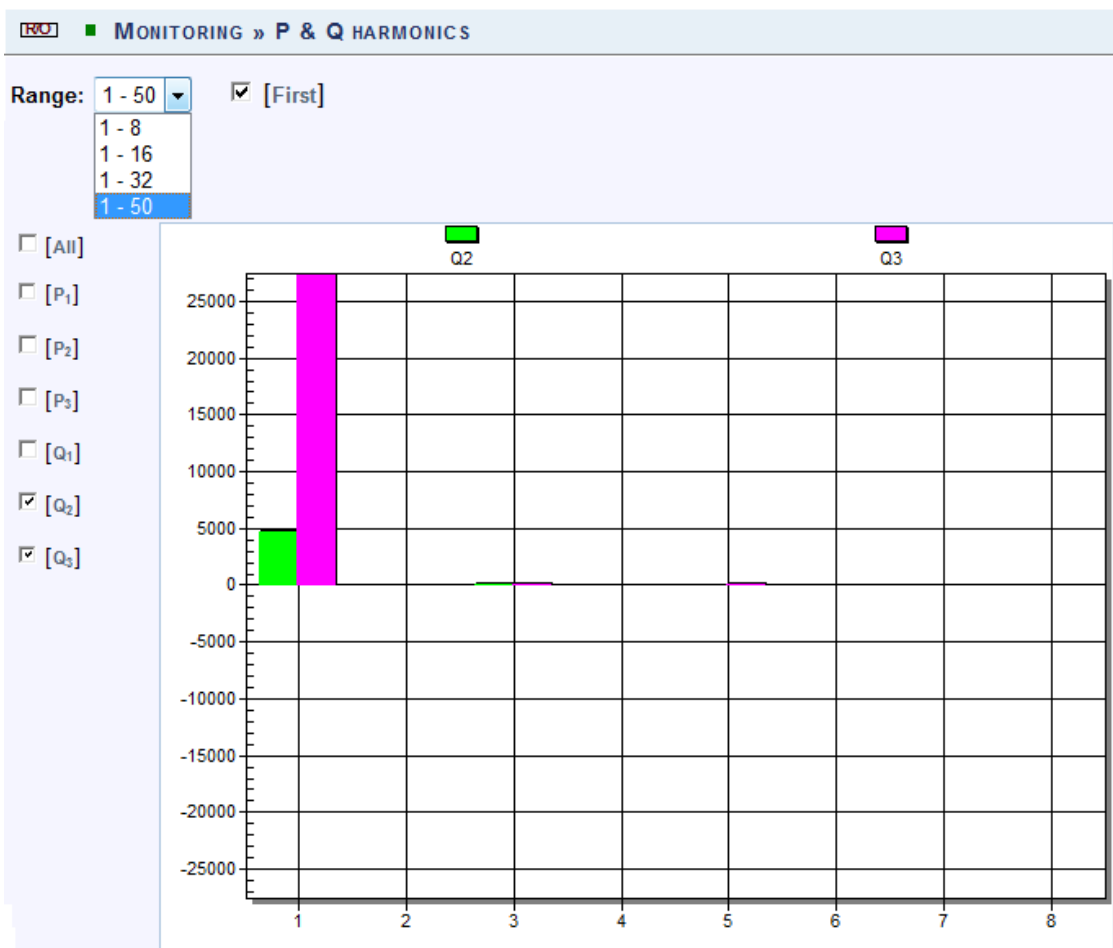

The table outlines the sections' Parameter options (for your selection) including their Definition:

PARAMETER	DEFINITION
RANGE	
1-8	Select the number of harmonics to be displayed 1-8
1-16	Select the number of harmonics to be displayed 1-16
1-32	Select the number of harmonics to be displayed 1-32
1-50	Select the number of harmonics to be displayed 1-50
OPTIONS	
First	Select either Yes/No in order to display or not display the first harmonic
All	Checking the "All" will display all the channels
P1	Checking the "P1" box will display the Active Power (P) of the first line

PARAMETER	DEFINITION
OPTIONS	
P2	Checking the "P2" box will display the Active Power (P) of the second line
P3	Checking the "P3" box will display the Active Power (P) of the third line
Q1	Checking the "Q1" box will display the Reactive Power (Q) of the first line
Q2	Checking the "Q2" box will display the Reactive Power (Q) of the second line
Q3	Checking the "Q3" box will display the Reactive Power (Q) of the third line

CHART OPTIONS

- By right-clicking on the chart you have various chart options & capabilities available to you:

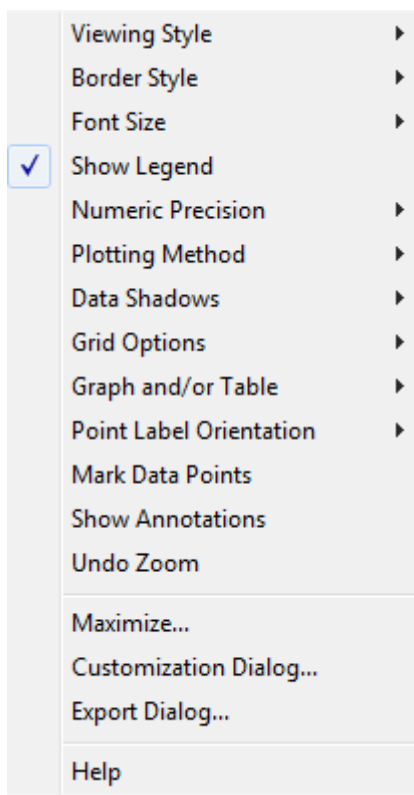

- Viewing Style: Different styling options Color / Monochrome (B&W) with/without Symbols / Bitmap etc. By selecting the option you can view on screen the different styles available to you
- Border Style: No Border, Thin Line, Shadow / Inset
- Font Size: Large / Medium / Small
- Display / Not display Legend
- Numeric Precision: No up to 3 Decimals
- Plotting Method: From Line / Bar / Point / Area / Spline / Combinations
- Data Shadows: Off / Shadow / 3D
- Grid Options: Various grid options ranging from dots / lines / different axis etc.
- Graph & Table: Display either the graph / table / both:

Q1	-0.610	0.316	0.487	-0.659	-0.220	0.512	-0.413	-1.240	-0.145	0.245
Q2	-0.514	0.270	0.245	-0.586	-0.219	0.391	-0.075	-0.516	0.097	0.195
Q3	-0.927	0.439	0.463	-0.903	-0.367	0.756	-0.243	-0.876	0.465	0.318
QN										

- Point Label Orientation: Auto / Vertical / Horizontal / Slanted
- Mark Data Points: Displays data points on graph
- Show Annotations: Displays annotations data descriptions
- Zoom / Undo Zoom - Zoom in /out on your graph:
 - From the main Waveform window, select an area to zoom in. Left-click and drag the mouse to define the area:

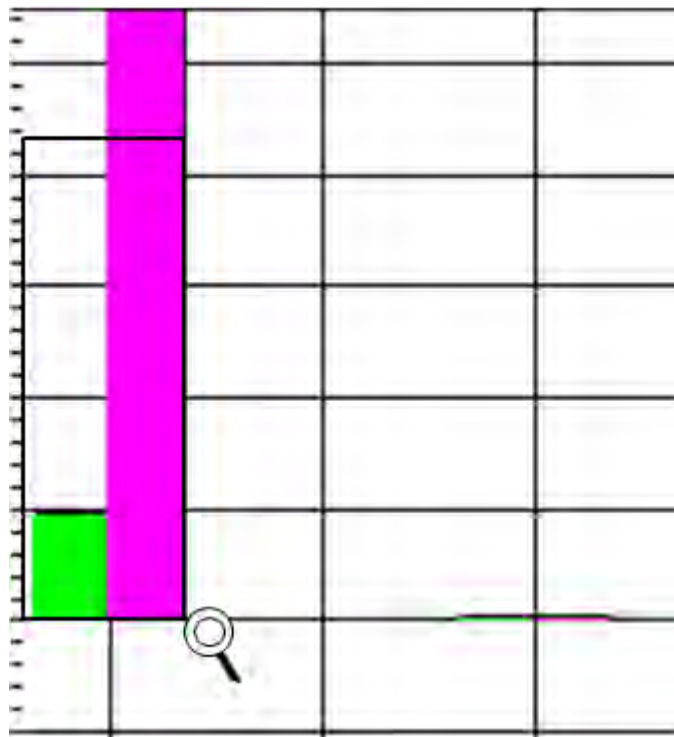

- The enlarged area will now appear in the window

- Zoom out by right/click → & select Zoom out
- Maximize: Maximize / Minimize graph
- Customization Dialog - Various General Graph Customization Options (all options apart from zooming above):

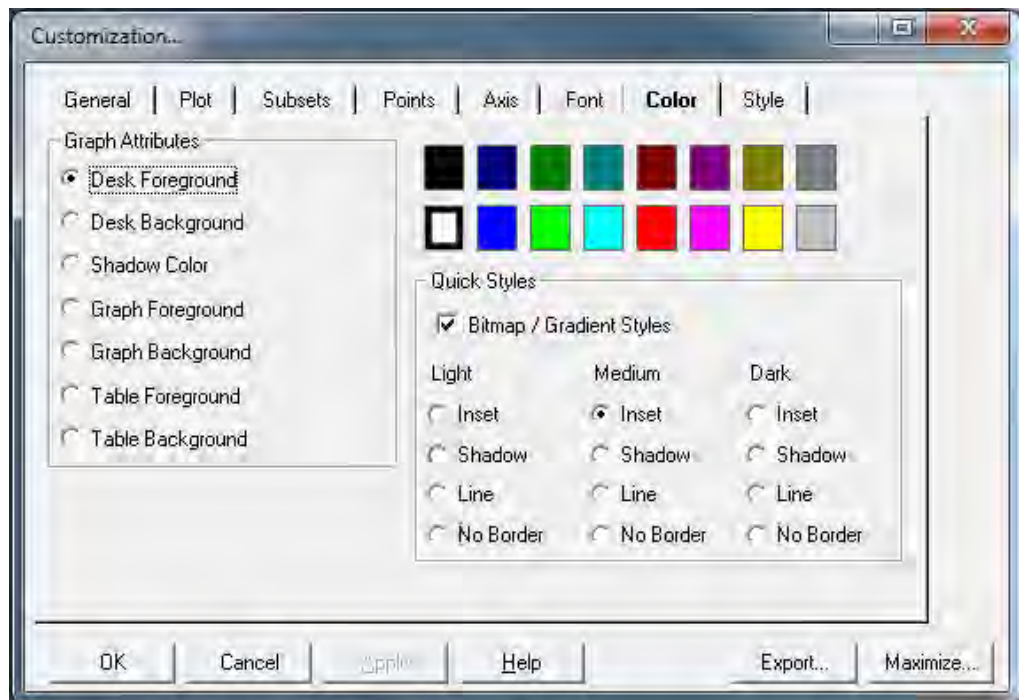

- Export Dialog - Various Export Options:

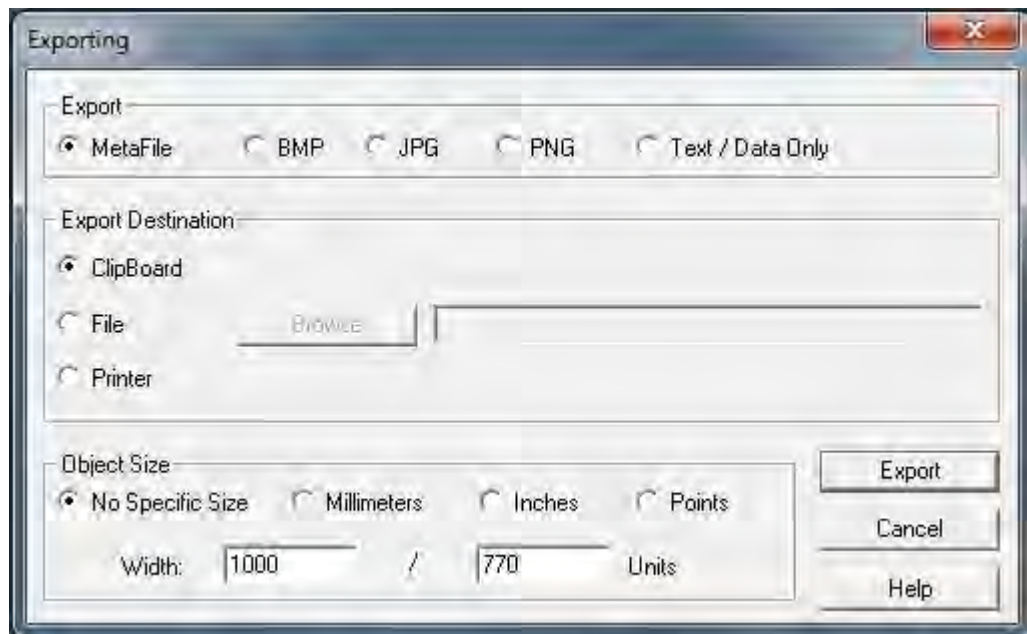

SEE ALSO

- [Monitoring Real-Time Data](#)
- [Voltage & Current Measurements](#)
- [Average](#)
- [Power](#)
- [Temperature](#)
- [Phasors](#)
- [Waveforms](#)
- [Voltage Flickering](#)
- [Pinst Waveform](#)
- [Minimum / Maximum Flickering](#)
- [Voltage & Current Harmonics](#)
- [Spectrum](#)
- [Harmonics Table](#)
- [Voltage & Current, Min & Max Harmonics Table](#)
- [PQ Min & Maximum Harmonics](#)

Spectrum

This window opens the Voltage & Current Sub & Inter-Harmonics measured by your G4K Unit.

OPEN THE SPECTRUM WINDOW

- [Access your G4K Unit](#) via the Web Interface → select Monitoring
→ Spectrum:

MONITORING	ENERGY	POWER QUALITY
Summary	V & I harmonics	
Voltage & Current	P & Q harmonics	
Average	<u>Spectrum</u>	
Power	Harmonics Table	
Temperature	V/I Min/Max Harmonics	
Phasors	P/Q Min/Max Harmonics	
Waveforms		
Voltage Flickering		
Pinst Waveform		
Min/Max Flickering		

- The Spectrum Window will now open:

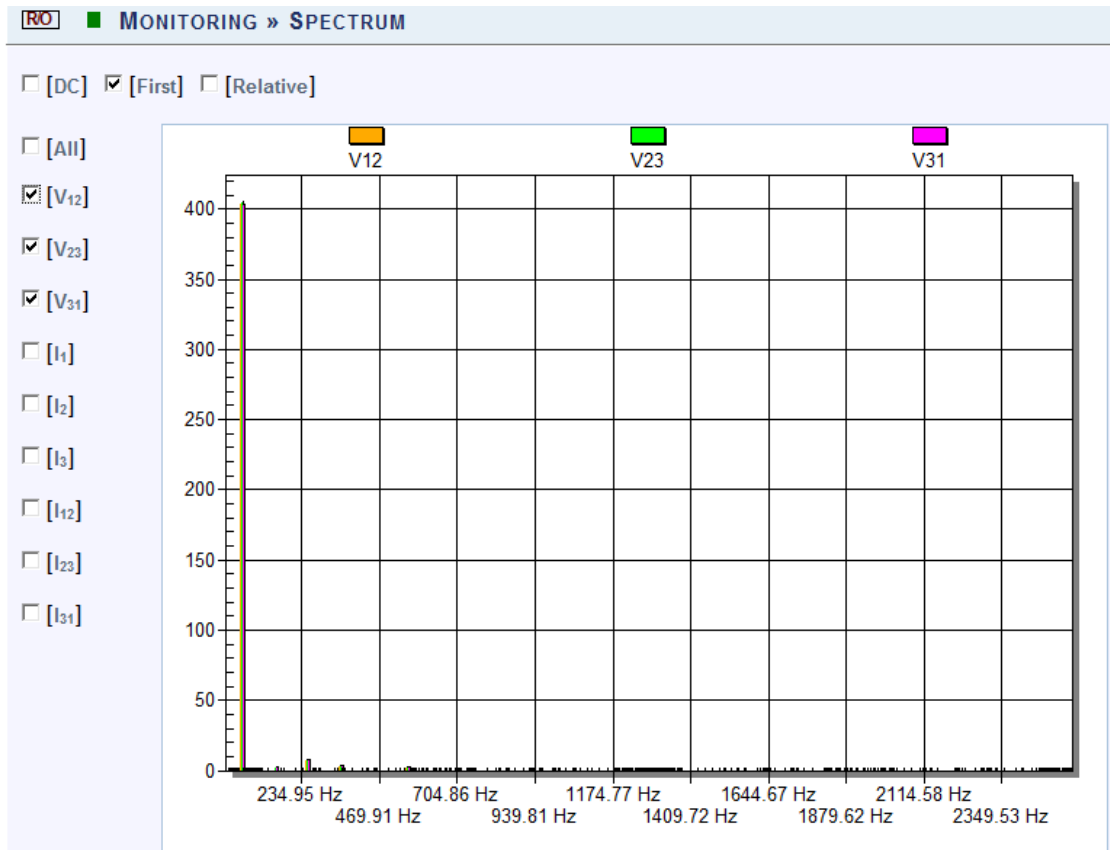

The table outlines the sections' Parameter options (for your selection) including their Definition:

PARAMETER	DEFINITION
DC	Check/Uncheck the checkbox in order to display/not display the DC Harmonics
First	Check/Uncheck the checkbox in order to display/not display the First Harmonic
Relative	Check/Uncheck the checkbox in order to display/not display the harmonics relative to the first harmonic (Whereas the first harmonic is 100, and the other harmonic values as part of the harmonic 100)
All	Checking the "All" will display all the channels
Voltage & Current	Select the applicable Voltage / Current channel to be displayed

CHART OPTIONS

- By right-clicking on the chart you have various chart options & capabilities available to you:

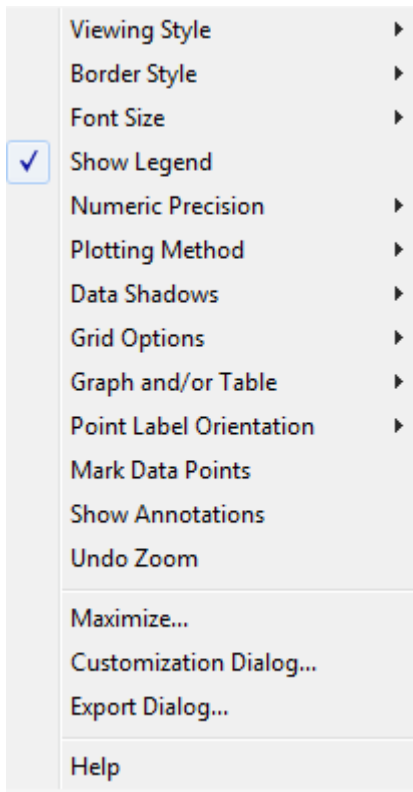



- Viewing Style:** Different styling options Color / Monochrome (B&W) with/without Symbols / Bitmap etc. By selecting the option you can view on screen the different styles available to you
- Border Style:** No Border, Thin Line, Shadow / Inset
- Font Size:** Large / Medium / Small
- Display / Not display Legend**
- Numeric Precision:** No up to 3 Decimals
- Plotting Method:** From Line / Bar / Point / Area / Spline / Combinations
- Data Shadows:** Off / Shadow / 3D
- Grid Options:** Various grid options ranging from dots / lines / different axis etc.
- Graph & Table:** Display either the graph / table / both:

	291.40 Hz	310.00 Hz	328.60 Hz	347.20 Hz	365.80 Hz	384.40 Hz	403.00 Hz	421.60 Hz	440.20 Hz	458.80 Hz	477.40 Hz	496.00 Hz
V1	0.000	0.002	0.004	0.022	0.003	0.002	0.002	0.003	0.004	0.002	0.000	0.001
V2	0.000	0.001	0.003	0.017	0.002	0.002	0.001	0.003	0.001	0.001	0.000	0.001
V3	0.001	0.001	0.003	0.027	0.004	0.002	0.002	0.002	0.003	0.003	0.001	0.001

- Point Label Orientation:** Auto / Vertical / Horizontal / Slanted
- Mark Data Points:** Displays data points on graph
- Show Annotations:** Displays annotations data descriptions

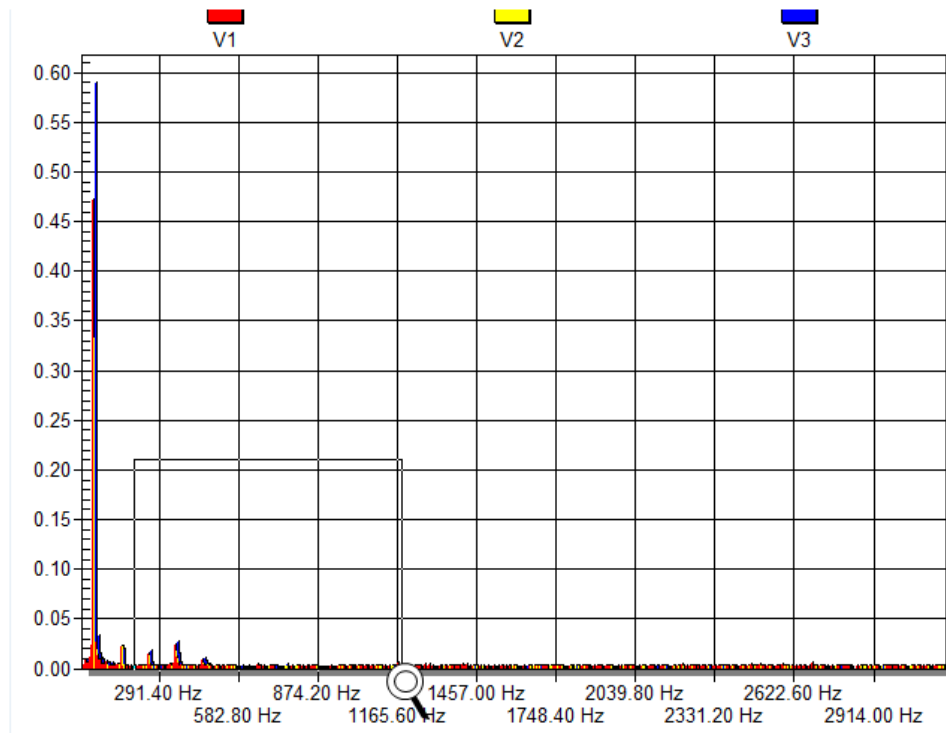
- From the main Waveform window, select an area to zoom in. Left-click and drag the mouse to define the area:



- The enlarged area will now appear in the window
- Zoom out by right/click  & select Zoom out
- Maximize: Maximize / Minimize graph
- Customization Dialog - Various General Graph Customization Options (all options apart from zooming above):

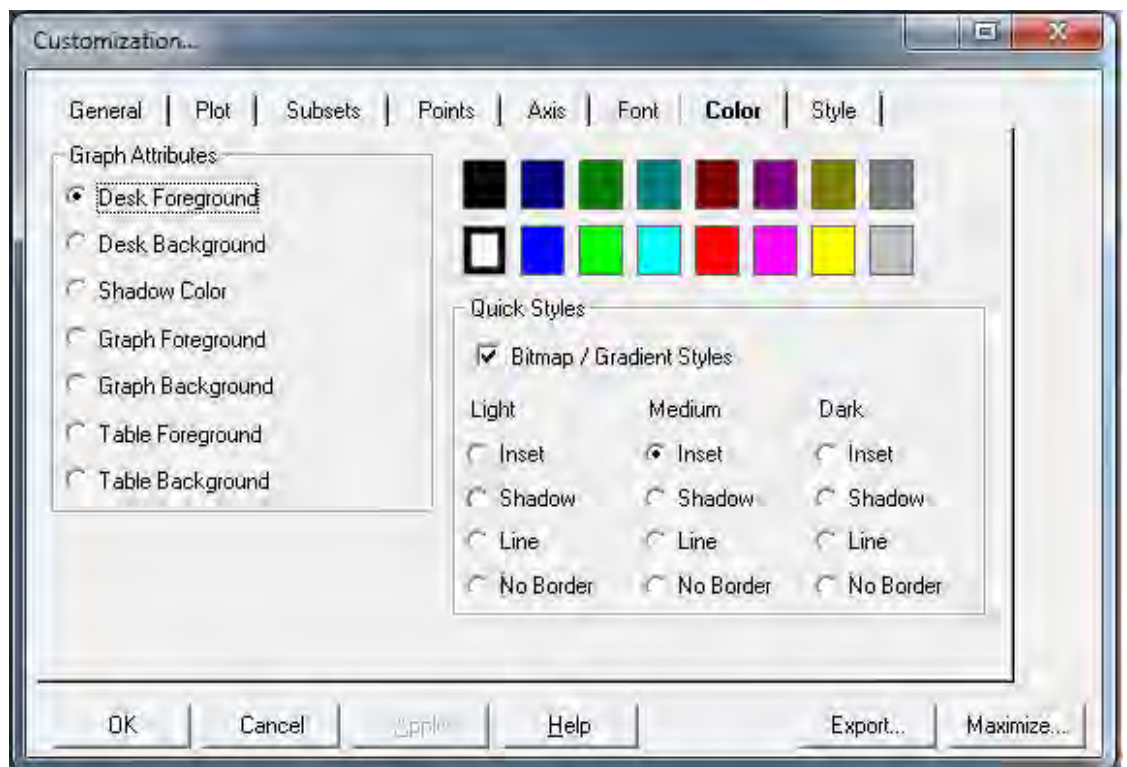

- Export Dialog - Various Export Options:

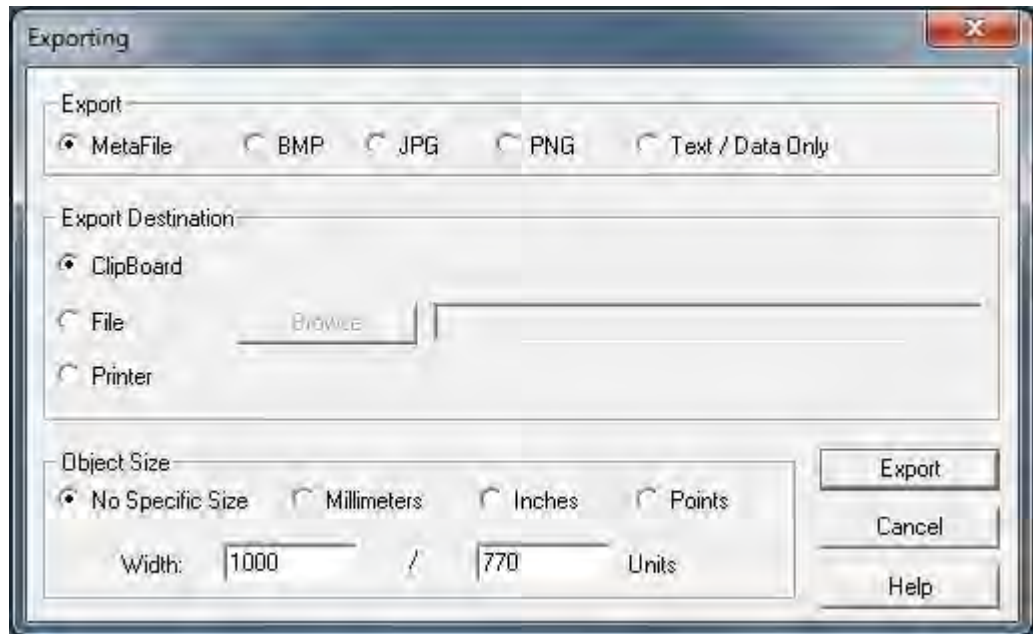

SEE ALSO

- [Monitoring Real-Time Data](#)
- [Voltage & Current Measurements](#)
- [Average](#)
- [Power](#)
- [Temperature](#)
- [Phasors](#)
- [Waveforms](#)
- [Voltage Flickering](#)
- [Pinst Waveform](#)
- [Minimum / Maximum Flickering](#)
- [Voltage & Current Harmonics](#)
- [P & Q Harmonics](#)
- [Harmonics Table](#)
- [Voltage & Current, Min & Max Harmonics Table](#)
- [PQ Min & Maximum Harmonics](#)

Harmonics Table

This page summarizes all the Voltage & Current Harmonics in either Voltage - Percentages or Angles - up to the 50th Harmonic.

OPEN THE HARMONICS TABLE WINDOW

- Access your [G4K Unit](#) via the Web Interface → select Monitoring → Harmonics Table:

MONITORING	ENERGY	POWER QUALITY
Summary	V & I harmonics	
Voltage & Current	P & Q harmonics	
Average	Spectrum	
Power	Harmonics Table	
Temperature	V/I Min/Max Harmonics	
Phasors	P/Q Min/Max Harmonics	
Waveforms		
Voltage Flickering		
Pinst Waveform		
Min/Max Flickering		

- The Harmonics Table Window will now open:

MONITORING » HARMONICS TABLE												
	150/180 Cycles	10 Min.	2 Hours									
Timestamp	17/07/2011 13:04:21	17/07/2011 13:00:00	17/07/2011 12:00:00									
Flag	Flagged: V1,V2,V3	Flagged: V1,V2,V3	Flagged: V1,V2,V3									
Measurement Type	Harmonics Harmonics Interharmonics 150/180 Cycles Harmonic 150/180 Cycles Interharmonic 10 min Harmonic 10 min Interharmonic 2 hour Harmonic 2 hour Interharmonic Harmonic's Angle											
Range:	1 - 128											
<input type="checkbox"/> [Relative]												
V & I Harmonics												
	V ₁	V ₂	V ₃	V _N	V ₁₂	V ₂₃	V ₃₁	I ₁	I ₂	I ₃	I _N	
H ₁	0.035 V	0.024 V	0.043 V	0.002 V	0.011 V	0.019 V	0.008 V	0 A	0 A	0 A	0 A	
H ₂	0.004 V	0.003 V	0.004 V	0.004 V	0.002 V	0.002 V	0.002 V	0 A	0 A	0 A	0 A	
H ₃	0.002 V	0.002 V	0.003 V	0.003 V	0.003 V	0.002 V	0.003 V	0 A	0 A	0 A	0 A	
H ₄	0.016 V	0.012 V	0.018 V	0.001 V	0.005 V	0.007 V	0.002 V	0 A	0 A	0 A	0 A	
H ₅	0.002 V	0.001 V	0.004 V	0.005 V	0.002 V	0.003 V	0.004 V	0 A	0 A	0 A	0 A	
H ₆	0.006 V	0.004 V	0.006 V	0.003 V	0.002 V	0.003 V	0.004 V	0 A	0 A	0 A	0 A	
H ₇	0.004 V	0.003 V	0.005 V	0.002 V	0.003 V	0.003 V	0.002 V	0 A	0 A	0 A	0 A	
H ₈	0.003 V	0.003 V	0.002 V	0.001 V	0.002 V	0.002 V	0.003 V	0 A	0 A	0 A	0 A	
H ₉	0.004 V	0.006 V	0.006 V	0.002 V	0.002 V	0.003 V	0.003 V	0 A	0 A	0 A	0 A	
H ₁₀	0.001 V	0.002 V	0.003 V	0.002 V	0.002 V	0.003 V	0.003 V	0 A	0 A	0 A	0 A	
H ₁₁	0.003 V	0.001 V	0.002 V	0.005 V	0.002 V	0.001 V	0.001 V	0 A	0 A	0 A	0 A	
H ₁₂	0.003 V	0.003 V	0.002 V	0.005 V	0.002 V	0.002 V	0.001 V	0 A	0 A	0 A	0 A	
H ₁₃	0.002 V	0.003 V	0.003 V	0.004 V	0.002 V	0.002 V	0.002 V	0 A	0 A	0 A	0 A	

The table outlines the sections' Parameters including Definition:

PARAMETER	DEFINITION
Timestamp	Indicates the timestamps of the last averaging intervals
Flag	Indicates whether or not the last interval is valid according to the set standard
MEASUREMENT TYPE	
Harmonics	Real time (10/12 cycles) calculation of sub group harmonics, in accordance with IEC61000-4-7: $G_{sg,n}^2 = \sum_{i=1}^1 C_{k+i}^2$
Interharmonics	Real time (10/12 cycles) calculation of inter sub group harmonics, in accordance with IEC61000-4-7
150/180 Cycles Harmonic	150/180 Cycle averaging of the sub group harmonics
MEASUREMENT TYPE	
150/180 Cycles Interharmonic	150/180 Cycle averaging of the inter sub group harmonics
10 Min Harmonic	10 Minutes averaging of the sub group harmonics
10 Min Interharmonic	10 Minutes averaging of the inter sub group harmonics
2 Hour Harmonic	2 Hours averaging of the 10 minutes averaging of the sub group harmonics
2 Hour Interharmonic	2 Hours averaging of the 10 minutes averaging of the inter sub group harmonics
Harmonic's Angle	The angle of each harmonic based on the real time value

PARAMETER	DEFINITION
RANGE	
1-128	Select the number of harmonics to be displayed 1-128
129-256	Select the number of harmonics to be displayed 129-256
257-384	Select the number of harmonics to be displayed 257-384
1-50	Select the number of harmonics to be displayed 285-511
OPTIONS	
First	Check/Uncheck the checkbox in order to display/not display the First Harmonic
Relative	Check/Uncheck the checkbox in order to display/not display the harmonics relative to the first harmonic (Whereas the first harmonic is 100, and the other harmonic values as part of the harmonic 100)
All	Checking the "All" will display all the channels
Voltage & Current	Select the applicable Voltage / Current channel to be displayed

SEE ALSO

- [Monitoring Real-Time Data](#)
- [Voltage & Current Measurements](#)
- [Average](#)
- [Power](#)
- [Temperature](#)
- [Phasors](#)
- [Waveforms](#)
- [Voltage Flickering](#)
- [Pinst Waveform](#)
- [Minimum / Maximum Flickering](#)
- [Voltage & Current Harmonics](#)
- [P & Q Harmonics](#)
- [Spectrum](#)
- [Voltage & Current, Min & Max Harmonics Table](#)
- [PQ Min & Maximum Harmonics](#)

Voltage & Current, Min & Max Harmonics Table

For each Harmonic, there is a Minimum & Maximum value for Voltage & Current. Voltage values are seen as phase to phase, while currents are displayed in both phase to neutral and phase to phase combinations. This page summarizes all the minimum Voltage & Current Harmonics Values.

OPEN THE V/I MIN/MAX HARMONICS WINDOW

- [Access your G4K Unit](#) via the Web Interface → select Monitoring → V/I Min/Max Harmonics:

MONITORING	ENERGY	POWER QUALITY
Summary		V & I harmonics
Voltage & Current		P & Q harmonics
Average		Spectrum
Power		Harmonics Table
Temperature		<u>V/I Min/Max Harmonics</u>
Phasors		P/Q Min/Max Harmonics
Waveforms		
Voltage Flickering		
Pinst Waveform		
Min/Max Flickering		

- The window containing the table for V/I Min/Max Harmonics values will now open:

RO ■ MONITORING » V/I MIN/MAX HARMONICS

[Harmonic's Angle] [Harmonics] Reset All Min/Max

Hamonics Min & Max

		V ₁	V ₂	V ₃	V _N	V ₁₂	V ₂₃	V ₃₁	I ₁	I ₂	I ₃	I _N
H ₁	Min.	0 °	0 °	0 °	0 °	0 °	0 °	0 °	0 °	0 °	0 °	0 °
	Max.	0 °	0 °	0 °	0 °	0 °	0 °	0 °	0 °	0 °	0 °	0 °
H ₂	Min.	90.54 °	90.32 °	90.77 °	90.62 °	90.52 °	90.49 °	90.31 °	90.3 °	90.17 °	90.17 °	90.17 °
	Max.	89.94 °	89.83 °	89.92 °	89.2 °	89.91 °	89.98 °	89.61 °	89.19 °	89.16 °	88.5 °	89.17 °
H ₃	Min.	-179.21 °	-178.99 °	-179.16 °	-179.64 °	-179.73 °	-179.25 °	-179.14 °	-179.8 °	-179.82 °	-179.74 °	-179.74 °
	Max.	179.67 °	179.73 °	179.67 °	179.31 °	179.68 °	179.78 °	179.19 °	178.4 °	179.32 °	178.67 °	178.67 °
H ₄	Min.	-89.93 °	-89.78 °	-89.94 °	-89.73 °	-89.92 °	-89.75 °	-89.82 °	-89.92 °	-89.63 °	-88.58 °	-89.63 °
	Max.	-90.83 °	-90.46 °	-90.49 °	-91.31 °	-90.54 °	-90.36 °	-90.13 °	-91.56 °	-91.55 °	-91.57 °	-91.57 °
H ₅	Min.	1.76 °	3.88 °	6.37 °	0.35 °	0.68 °	0.37 °	0.62 °	0.21 °	0.28 °	0.18 °	0.18 °
	Max.	-0.43 °	-1.79 °	-2.95 °	-1.84 °	-0.75 °	-0.58 °	-0.61 °	-2.45 °	-2.12 °	-2.24 °	-2.24 °
H ₆	Min.	90.76 °	90.58 °	90.71 °	90.83 °	90.91 °	90.73 °	90.87 °	91.03 °	90.57 °	91.97 °	90.57 °
	Max.	89.6 °	89.4 °	89.35 °	86.07 °	89.76 °	89.93 °	89.67 °	88.3 °	86.69 °	87.75 °	88.3 °

[Harmonic's Angle] [Harmonics] Reset All Min/Max

Hamonics Min & Max

		V ₁	V ₂	V ₃	V _N	V ₁₂	V ₂₃	V ₃₁	I ₁	I ₂	I ₃	I _N
H ₁	Min.	0.238789 V	0.226673 V	0 V	0.004628 V	0.050601 V	0.200605 V	0.026388 V	0.000027 A	0.000027 A	0.000027 A	0.000027 A
	Max.	580.0203 V	579.5482 V	579.2297 V	0.278288 V	938.9716 V	892.5665 V	779.7667 V	7.521795 A	7.7881 A	7.7881 A	7.7881 A
H ₂	Min.	0 V	0 V	0 V	0.002842 V	0 V	0 V	0 V	0 A	0 A	0 A	0 A
	Max.	292.0032 V	291.9152 V	292.075 V	0.301872 V	505.7 V	505.7998 V	505.6862 V	4.86679 A	4.8663 A	4.8663 A	4.8663 A
H ₃	Min.	0 V	0 V	0 V	0.001904 V	0 V	0 V	0 V	0 A	0 A	0 A	0 A
	Max.	283.6053 V	283.5094 V	283.484 V	0.311903 V	490.5724 V	491.1991 V	491.0893 V	4.715968 A	4.7143 A	4.7143 A	4.7143 A
H ₄	Min.	0 V	0 V	0 V	0.001875 V	0 V	0 V	0 V	0 A	0 A	0 A	0 A
	Max.	15.61425 V	11.85983 V	30.70399 V	0.310827 V	22.46254 V	33.34052 V	34.75038 V	0.286217 A	0.4925 A	0.4925 A	0.4925 A
H ₅	Min.	0 V	0 V	0 V	0.002183 V	0 V	0 V	0 V	0 A	0 A	0 A	0 A
	Max.	11.89672 V	8.270914 V	23.3184 V	0.308923 V	17.11787 V	25.33559 V	26.48107 V	0.167848 A	0.2531 A	0.2531 A	0.2531 A
H ₆	Min.	0 V	0 V	0 V	0.002499 V	0 V	0 V	0 V	0 A	0 A	0 A	0 A
	Max.	9.661383 V	6.722422 V	19.28315 V	0.313419 V	13.86855 V	21.00695 V	21.87988 V	0.130442 A	0.2447 A	0.2447 A	0.2447 A
H ₇	Min.	0 V	0 V	0 V	0.002612 V	0 V	0 V	0 V	0 A	0 A	0 A	0 A
	Max.	8.149029 V	5.67745 V	16.1435 V	0.309785 V	11.68545 V	17.76667 V	18.58083 V	0.112723 A	0.1866 A	0.1866 A	0.1866 A

The table outlines the sections' Parameters including Definition:

PARAMETER	DEFINITION
Harmonics Angle	Check in order to display the Min/Max value of the Harmonics Angle
Harmonics Value	Check in order to display the Min/Max value of the Harmonics Value (amplitude)
Reset All Min/Max	Reset all Min/Max measurements of your G4K Unit

SEE ALSO

- [Monitoring Real-Time Data](#)
- [Voltage & Current Measurements](#)
- [Average](#)
- [Power](#)
- [Temperature](#)
- [Phasors](#)
- [Waveforms](#)
- [Voltage Flickering](#)
- [Pinst Waveform](#)
- [Minimum / Maximum Flickering](#)
- [Voltage & Current Harmonics](#)
- [P & Q Harmonics](#)
- [Spectrum](#)
- [Harmonics Table](#)
- [PQ Min & Maximum Harmonics](#)

PQ Min & Maximum Harmonics

This page summarizes all the minimum & maximum Active & Reactive Power Harmonic Values per phase, up to the 50th Harmonic.

- (P) = Active Power Harmonic Values
- (Q) = Reactive Power Harmonic Values

OPEN THE P/Q MIN/MAX HARMONICS WINDOW

- [Access your G4K Unit](#) via the Web Interface → select Monitoring → P/Q Min/Max Harmonics:

MONITORING	ENERGY	POWER QUALITY
Summary		V & I harmonics
Voltage & Current		P & Q harmonics
Average		Spectrum
Power		Harmonics Table
Temperature		V/I Min/Max Harmonics
Phasors		<u>P/Q Min/Max Harmonics</u>
Waveforms		
Voltage Flickering		
Pinst Waveform		
Min/Max Flickering		

- The window containing the table for P/Q Min/Max Harmonics values will now open:

Reset All Min/Max

P & Q min-max harmonics

		P ₁	P ₂	P ₃	P _N	Q ₁	Q ₂	Q ₃
1	Min.	-0.084122 kW	-0.010523 kW	-0.018131 kW	-0.000111 kW	-0.598618 kVAr	-0.191277 kVAr	-0.115993 kVAr
	Max.	1.499689 kW	1.499878 kW	1.513583 kW	0.000101 kW	0.599336 kVAr	0.189146 kVAr	0.082983 kVAr
2	Min.	-0.001169 kW	-0.002675 kW	-0.019172 kW	-0.000003 kW	-0.003728 kVAr	-0.005166 kVAr	-0.017188 kVAr
	Max.	0.005582 kW	0.006626 kW	0.008249 kW	0.000004 kW	0.004161 kVAr	0.004809 kVAr	0.002695 kVAr
3	Min.	-0.002878 kW	-0.000327 kW	-0.000634 kW	-0.000037 kW	-0.044301 kVAr	-0.127869 kVAr	-0.000565 kVAr
	Max.	1.498903 kW	1.498402 kW	1.498557 kW	0.000019 kW	0.043294 kVAr	0.004553 kVAr	0.120384 kVAr
4	Min.	-0.000449 kW	-0.000361 kW	-0.000891 kW	-0.000006 kW	-0.000576 kVAr	-0.000191 kVAr	-0.000626 kVAr
	Max.	0.000833 kW	0.000473 kW	0.001512 kW	0.000006 kW	0.000645 kVAr	0.000156 kVAr	0.000843 kVAr
5	Min.	-0.000222 kW	-0.000057 kW	-0.000335 kW	-0.000001 kW	-0.000248 kVAr	-0.000119 kVAr	-0.000291 kVAr
	Max.	0.000516 kW	0.00031 kW	0.000544 kW	0.000001 kW	0.000236 kVAr	0.000095 kVAr	0.000548 kVAr
6	Min.	-0.000041 kW	-0.000053 kW	-0.000302 kW	-0.000001 kW	-0.000186 kVAr	-0.000081 kVAr	-0.00069 kVAr
	Max.	0.000408 kW	0.000202 kW	0.00082 kW	0.000001 kW	0.000245 kVAr	0.000068 kVAr	0.000389 kVAr
7	Min.	-0.000059 kW	-0.000068 kW	-0.001489 kW	-0.000003 kW	-0.000103 kVAr	-0.000049 kVAr	-0.004187 kVAr
	Max.	0.000306 kW	0.000135 kW	0.001928 kW	0.000003 kW	0.000188 kVAr	0.000053 kVAr	0.001803 kVAr

The table outlines the sections' Parameters including Definition:

PARAMETER	DEFINITION
P1	Displays the Active Power (P) of the first line
P2	Displays the Active Power (P) of the second line
P3	Displays the Active Power (P) of the third line
Q1	Displays the Reactive Power (Q) of the first line
Q2	Displays the Reactive Power (Q) of the second line
Q3	Displays the Reactive Power (Q) of the third line
Reset All Min/Max	Reset all Min/Max measurements of your G4K Unit

SEE ALSO

- [Monitoring Real-Time Data](#)
- [Voltage & Current Measurements](#)
- [Average](#)
- [Power](#)
- [Temperature](#)
- [Phasors](#)
- [Waveforms](#)
- [Voltage Flickering](#)
- [Pinst Waveform](#)
- [Minimum / Maximum Flickering](#)
- [Voltage & Current Harmonics](#)
- [P & Q Harmonics](#)
- [Spectrum](#)
- [Harmonics Table](#)
- [Voltage & Current, Min & Max Harmonics Table](#)

About Power Quality Monitoring

The BLACKBOX contains a power quality compliance engine that enables real-time evaluation of power quality according to standards such as EN50160. Power Quality (PQ) Compliance is a set of electrically measured parameters which are typically calculated based on some pre-defined intervals or event triggers and are evaluated over a large observation window. For most of the PQ parameters, the observation window is one week, which means the displayed online information refers to the previous week. However, using ELSPEC's PQSCADA and Investigator applications, all time intervals are able to be observed.

A PQ parameter is typically based on a power quality event. For example, the DIP PQ parameter is based on counting DIP events over some observation period.

Different national standards vary the way a specific PQ parameter is being measured or observed. The PQ Engine also supports a mode that can be customized by the user, in which all compliance parameters can be self-edited and modified in order to meet new conditions, rules, measuring intervals, and even different observation periods.

The Power Quality section in ELSPEC's Web Interface is used to control and view power quality measurement and compliance information computed by the PQ Engine that includes:

- [View & Evaluate Summary of the Compliance Engine](#)
- [View Detailed Compliance Information](#)
- [View Graphical Bars of Compliance Levels](#)
- [Set & View Log of Events](#)

PQ Compliance Summary

In this window you are able to review the specific Compliance Standard & Status that is being evaluated by your G4K Unit's Internal Compliance Engine.

OPEN THE COMPLIANCE SUMMARY WINDOW

- [Access your G4K Unit](#) → log on as the Viewer/Administrator → under Power Quality → open the Summary Tab:

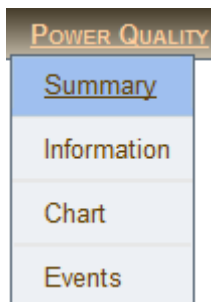

- The Summary window will now open:

A screenshot of the "POWER QUALITY » SUMMARY" window. The window title bar shows "RO" and "POWER QUALITY » SUMMARY". The main content is divided into two panels: "Event Status" and "Compliance Summary".

Event Status	
Voltage Frequency	OK
Supply Voltage Variations	OK
Rapid Voltage Changes	OK
Supply Voltage Dips	FAIL
Short Interruptions	OK
Long Interruptions	OK
Temporary Overvoltage	OK
Flicker Severity	OK
Harmonic Voltage	OK
Supply Voltage Unbalance	OK

Compliance Summary	
Compliance Type	EN50160
Running Status	Running
Embedded Report	None
Evaluation Status	OK
Start Time	***
Window Time On	7:0:34:15 D:H:M:S
Window Time Off	0:0:0:0 D:H:M:S
Measurement Flag	Flagged: V1,V2,V3

EVENT STATUS SECTION

The Events Status Table shows a high level PASS or FAIL indication of each PQ parameter. Any PQ parameter that has an incomplete observation period will be presented as N/A (Not Available). The definitions defined below are [PQ Parameters Configured](#) as per EN50160 compliance. You may choose any other [PQ Compliance](#) or set your own [Unique PQ Compliance](#):

- **Voltage Frequency OK/FAIL:** Frequency compliance is based on statistics: N, N1 & N2. Frequency measurement interval is 10 sec. in an entire observation window of 1 week. N - amount of intervals. N1 - intervals frequency exceeded [+1.00%,-1.00%] from Nominal Frequency. N2 - intervals frequency exceeded [+4.00%,-6.00%] from Nominal Frequency. N1 & N2 increment only if valid voltage inside nominal boundary of [+15.0%,-15.0%]. Compliance if both $N1/N \leq 5\%$ of time & $N2=0$ of time. Intervals with voltage interruption are discarded. Intervals with DIPS or Over voltage are discarded.
- **Supply Voltage Variations OK/FAIL:** Variations are evaluated by collecting statistics: N, N1 & N2. Statistics are collected as average voltage within intervals of 10 min. in observation window of 1 week. N - amount of intervals. N1 - intervals voltage exceeded [+10.0%,-10.0%] boundary of nominal. N2 - intervals voltage exceeded [+15.0%,-15.0%] boundary of nominal. Compliance if $N1/N \leq 5\%$ & $N2=0$ during the entire observation window. Intervals with voltage interruption are discarded. Intervals with DIPS or OVER Voltage are discarded.
- **Rapid Voltage Changes OK/FAIL:** Rapid voltage change is based on a 3 sec. window in which RMS voltage minimum & maximum values are obtained (minimum/maximum values should be within $\pm 10.0\%$ from nominal). The rapid change is the percent of delta between minimum & maximum divided by average RMS of 9 sec. The Rapid percent results are evaluated during observation window of 1 week. Rapid changes are limited to specific count (N): Rapids of more 5.00% allowed: $N \leq 65536$ occurrences.
- **Supply Voltage Dips OK/FAIL:** DIP is a voltage drop of more than 10.0% from Nominal (but no more than 100.0%, & deactivate on 8.0%) DIP minimum time is 10 ms. & maximum time of 1 min. DIP events are counted per all phases combined within observation window of 1 week. Total events (N) allowed is: 20.
- **Short Interruptions OK/FAIL:** Short interruption is a voltage drop of less than 97.0% from nominal (event deactivate on 77.6%). Min duration 10 ms., Max duration 3 min. events are counted in the entire observation window of 1 week. Total events (N) allowed is: 2.
- **Long Interruptions OK/FAIL:** Long interruptions are the same as short ones but with a longer duration (longer than short interruption maximum time).

Long interruptions events are counted within observation window of 1 week. Total events (N) allowed is: 1.

- **Temporary Overvoltage OK/FAIL:** Over-voltage events are characterized with RMS voltage higher than 10.0% above Nominal (event deactivate on 8.0%). Minimum over-voltage event duration is 10 ms., events are counted per all phases combined within observation window of 1 week. No specific events count limitation is defined.
- **Flicker Severity OK/FAIL:** Flicker severity is evaluated within observation window of 1 week. During interruption Flicker interval is discarded. During DIPS or Over voltage Flicker Interval is discarded. P_{lt} (2 hours) must be equal or under 1.0 during 95.0% of observation time.
- **Harmonic Voltage OK/FAIL:** Harmonics evaluated at intervals of 10 min. within observation window of 1 week. Evaluation at intervals in which voltage is inside nominal boundary of [+15.0%, -15.0%]. Discarding Intervals with VOLT-INT. Discarding Intervals with DIPS or OVER-VOLT. Individual Harmonics are limited according to the following table: H₂≤2.0%, H₃≤5.0%, H₄≤1.0%, H₅≤6.0%, H₆≤0.5%, H₇≤5.0%, H₈≤0.5%, H₉≤1.5%, H₁₀≤0.5%, H₁₁≤3.5%, H₁₂≤0.5%, H₁₃≤3.0%, ... THD limit is set 8.0% (N₂). THD and Harmonics limits shall be kept at least 95.0% of time.
- **Supply Voltage Unbalance OK/FAIL:** Voltage unbalance is evaluated at intervals of 10 min. within observation window of 1 week. Evaluation is only at intervals in which voltage is inside nominal boundary of [+15.0%, -15.0%]. Unbalance limit N₁ is set to 2.00% and must be kept 95.0% of observation time. Intervals with voltage interruption are discarded. Intervals with DIPS or Over voltage are discarded.

COMPLIANCE SUMMARY SECTION

- The Compliance Type is configured when setting your Instrument in [PQ Compliance Configuration](#).
- Running Status means whether or not the G4K's Power Quality engine is evaluating the power quality according to the [Configured PQ Compliance](#).
- The Embedded Report field further indicates a type of report that is auto-generated internally in the device's file system. Most compliance types do not generate any specific report, & therefore, the report type will be None. However, CREG type of compliance (used in Colombia) also auto-generates a specific format of [Report Files](#) as defined by the local regulator.
- The Evaluation Status field provides an overall status of PASS or FAIL of the entire compliance. Anytime the evaluation period is not complete (typically required is a 1 week observation), the status will be N/A (Not Available), otherwise PASS will be indicated as OK.

- The Start Time field shows the last time the compliance engine was restarted. The entire state & observation window history is stored on the internal non-volatile memory, so even after powering down; the Engine will continue its evaluation & maintain all indications. (Start time remains unchanged after device powered up.)
- The Window Time On/Off fields specify how much aggregated time is already in the observation window. ON refers to the aggregated window time the device was powered on & OFF refers to the amount of window time the device power was off. The format presented is [Days: Hours: Minutes: Seconds]. Ideally the OFF time is all zeroes & the ON time is 7 days (which is the typical full observation period in most of the compliance types). Once the observation window reaches 7 days, it will start to slide in steps of 2 hours. Sliding means the information from the oldest 2 hours is being dropped, where a new up-to-date 2-hour interval is being used for calculations.
- The Measurement Flag field indicates whether there is a power quality event such as a DIP/SWELL or INTERRUPTION at the moment.

NOTE NOTE NOTE

All underlined parameters are accompanied by a Tool Tip, Right-click on the command to open the Tool Tip & x to close the Pop-up:

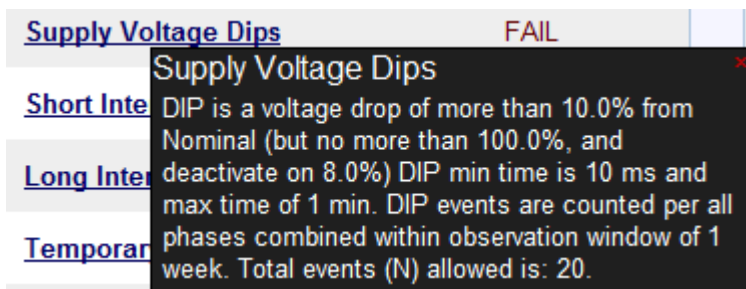

SEE ALSO:

- [About Power Quality Monitoring](#)
- [Compliance Information](#)
- [Compliance Chart](#)
- [Events](#)
- [PQ Compliance Configuration](#)

Compliance Information

This window contains detailed compliance information.

ACCESS THE COMPLIANCE INFORMATION WINDOW

- Access your G4K Unit → log on as the Viewer/Administrator → under Summary → open the Information Tab:

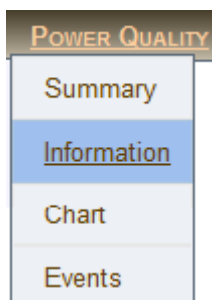

- The Information window will now open:

RO ■ POWER QUALITY » INFORMATION

Detailed Compliance Info		Compliance Status: Running				
	Status	Observation	Window Interval	Time OK	Time N/A	Total Events
	Partial			Time Fail		
Voltage Frequency	OK	Complete	1 week	100.000 %	0.0000 %	0
	OK			10 sec		
Supply Voltage Variations	OK	Complete	1 week	100.000 %	0.0000 %	0
	OK			10 min		
Rapid Voltage Changes	OK	Complete	1 week	100.000 %	0.0000 %	0
	OK			3 sec		
Supply Voltage Dips	FAIL	Complete	1 week	97.647 %	0.0000 %	4583
	OK			10 ms		
Short Interruptions	FAIL	Complete	1 week	96.498 %	0.0000 %	5
	OK			10 ms		
Long Interruptions	FAIL	Complete	1 week	97.675 %	0.0000 %	2
	OK			10 ms		
Temporary Overvoltage	OK	Complete	1 week	100.000 %	0.0000 %	10623
	OK			10 ms		
Flicker Severity	OK	Complete	1 week	100.000 %	0.0000 %	0
	OK			10 min		
Harmonic Voltage	OK	Complete	1 week	100.000 %	0.0000 %	0
	OK			10 min		
Supply Voltage Unbalance	OK	Complete	1 week	100.000 %	0.0000 %	0
	OK			10 min		

- **Status/Partial:** Contains two status indicators. The upper indicator refers to the entire observation window's PASS/FAIL result (same status as presented in the Summary page), while the lower indicator is a PASS/FAIL indicator of the most recent period. This recent indicator serves as real-time indicator & typically reflects to only minutes to a few hours of history (this is dependent on the specific PQ parameter measurement' intervals & method).
- **Observation:** Indicates whether the observation of a specific PQ parameter is complete.
- **Window/Interval:** *Upper Area* - Provides the observation window time (contains historical data used for the calculations). You may uniquely set the observation period in [User Defined Pages](#) (Options - 1 or 2 Hours, or 1 Day, or 1 Week, or 1 Year). *Lower Area* - Provides the measurement interval time or parameter resolution that falls within the observation window (the measured time length for the PQ parameter). The interval may also be set in [User Defined Pages](#) (Options - 1, 3, 10 or 20 seconds, or 1, 3, 10 or 30 minutes, or 1, or 2 Hours, or 1 Day). If you configure your PQ Compliance to a set standard (i.e. EN50160), the Observation Window & Interval Time will be calculated according to the standard.
- **Time OK/Time FAIL:** provides the percentage of time the PQ parameter was OK (as green text on the upper area) & percentage of time the PQ parameter was outside the defined limits or FAILED (as red text in the lower area) for the entire observation period (Observation Window). Example as per the Information Window: if Voltage Dips was observed for a period of 1 week at a resolution of 10 ms (interval), the PQ parameter was OK for 97.647% & FAILED for 2.352% of the time (observation week). It should not be confused to the lower area on the previous column.
- **Time N/A:** Provides the percentage of time the unit was not measuring due to lack of power.
- **Total Events:** Provides the overall number of PQ events influenced by the PQ parameter in the observation window.

NOTE NOTE NOTE

All underlined parameters are accompanied by a Tool Tip, Right-click on the command to open the Tool Tip & x to close the Pop-up:

<u>Temporary Overvoltage</u>	OK	Complete	1 week	10%
<u>Flicker Severity</u>	Temporary Overvoltage Over-voltage events are characterized with RMS voltage higher than 10.0% above Nominal (event deactivate on 8.0%). Min over-voltage event duration is 10 ms, events are counted per all phases combined within observation window of 1 week. No specific events count limitation defined.			
<u>Harmonic Voltage</u>				

SEE ALSO:

- [About Power Quality Monitoring](#)
- [PQ Compliance Summary](#)
- [Compliance Chart](#)
- [Events](#)
- [PQ Compliance Configuration](#)

Compliance Chart

This page displays graphical bars of compliance levels (equals to percentage of time OK).

ACCESS THE COMPLIANCE CHART WINDOW

- [Access your G4K Unit](#) → log on as the Viewer/Administrator → under Power Quality → open the Chart Tab:

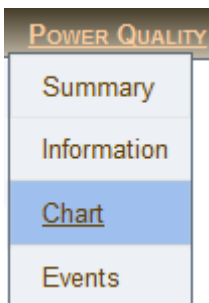

- The Compliance Chart window will now open:

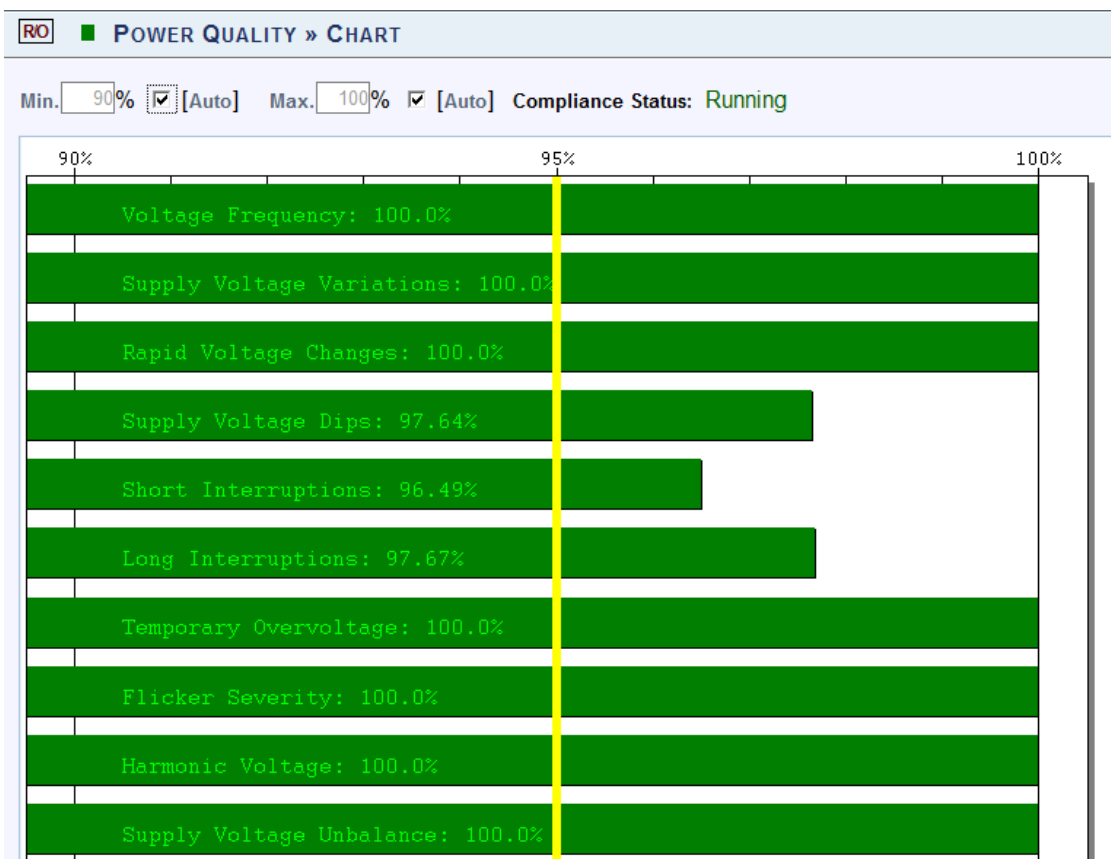

- The minimum and maximum values in the chart may be configured by deselecting Auto for each value (Default = 90% Min / 100% Max)

CHART OPTIONS

As the Compliance Chart is intended to be used only as a chart & regardless that all the options are displayed, only certain options & capabilities are available for the Compliance Chart.

- Right-click on the chart to access the options:

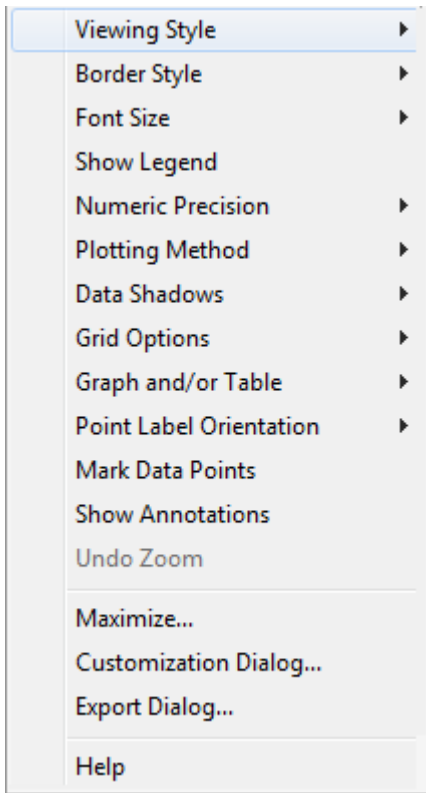

- You may use the following chart options & capabilities:
 - Viewing Style: Different styling options Color / Monochrome (B&W) with/without Symbols / Bitmap etc. By selecting the option you can view on screen the different styles available to you
 - Border Style: No Border, Thin Line, Shadow / Inset
 - Font Size: Large / Medium / Small
 - Data Shadows: Off / Shadow / 3D
 - Dialog - Various Export Options:

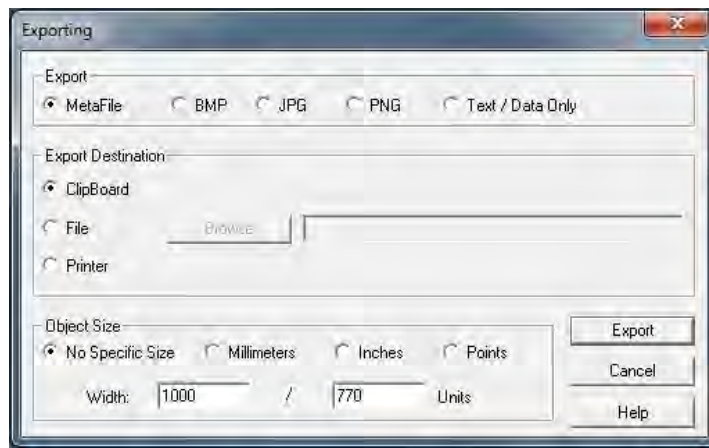

SEE ALSO:

- [About Power Quality Monitoring](#)
- [PQ Compliance Summary](#)
- [Compliance Information](#)
- [Events](#)
- [PQ Compliance Configuration](#)

Events

The Events window supplies a Log that displays [Configured PQ Events](#). Within in the Log you can decide what data you would like to display & produce a report.

OPEN THE EVENTS WINDOW TO PRODUCE A PQ EVENT LOG

- [Access your G4K Unit](#) → log on as the Viewer/Administrator → under Power Quality → open the Event Tab:

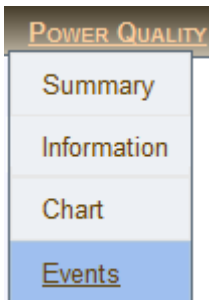

- The Event Log window will now open:

The screenshot shows the "POWER QUALITY » EVENTS" window. At the top, there is a "Start at" field with a dropdown arrow, a "Page Size" field with a dropdown arrow set to 15, and a "Time" dropdown menu set to "UTC". A "Copy log to clipboard" button is also present. Below these controls is a "Logged Events" section with an "Erase Log" button and navigation arrows (<< and >>). A "Refresh Log" button is also visible. The main content is a table with the following data:

#	Event Timestamp	Code	Detailed Event Data
0	29/09/2010 08:00:01	242	PQ Voltage Flickering: 1.241312 (24.121094[dev%] 7200.000000[sec] Severity:22 Phases:Delta 3 wires::23;31)
1	27/09/2010 10:00:00	242	PQ Voltage Flickering: 1.054226 (5.419922[dev%] 7200.000000[sec] Severity:20 Phases:Delta 3 wires::23;31)
2	26/09/2010 22:44:53	244	PQ Rapid Voltage Changes: 5.990278[%] (5.957031[dev%] 2.997351 [sec] Severity:37 Phases:Delta 3 wires:12;23;31)
3	26/09/2010 22:44:53	235	PQ Voltage Dips: 355.140625[V] (11.181641[dev%] 0.059910[sec] Severity:52 Phases:Delta 3 wires::23;31)
4	26/09/2010 06:00:00	242	PQ Voltage Flickering: 1.074149 (7.373047[dev%] 7200.000000[sec] Severity:20 Phases:Delta 3 wires::23;31)
5	24/09/2010 18:10:56	233	PQ Frequency Out of Range: 49.494373[Hz] (0.976563[dev%] 10.000000[sec] Severity:130 Phases:Delta 3 wires:)

Options & Functions:

- Start at: Specify the event range
- Page Size: Number of entries per page
- Time: Log entries will be displayed at specific time zone (UTC or Local time)

- **Copy log to clipboard**: Will copy the Event Log over to common Windows applications (Notepad, MS Outlook, Excel & Word). Simply select the command & Paste it in one of these applications.
- **Erase Log**: Will clear all the log entries & restart the System log from the time you select this option
- **<<**: Go to previous page
- **Refresh Log**: Refresh your view
- **>>**: Go to the next page

SEE ALSO:

- [About Power Quality Monitoring](#)
- [PQ Compliance Summary](#)
- [Compliance Information](#)
- [Compliance Chart](#)
- [PQ Compliance Configuration](#)
- [System Log](#)

PQZIP Recording - Principle

The G4K BLACKBOX is able to continuously record & store all the electrical waveforms, all the time, in the case of G44430 for more than a year, with no gaps in the data. The flow diagram & subsequent definitions outline the PQZIP process: The innovation behind this capability is the PQZIP compression technology. The patented PQZIP enables you to store up to a thousand times more information than typical formats, allowing for storage of complete & precise data over extended periods of time. The flow diagram & subsequent definitions outline the PQZIP process:

FLOW DIAGRAM

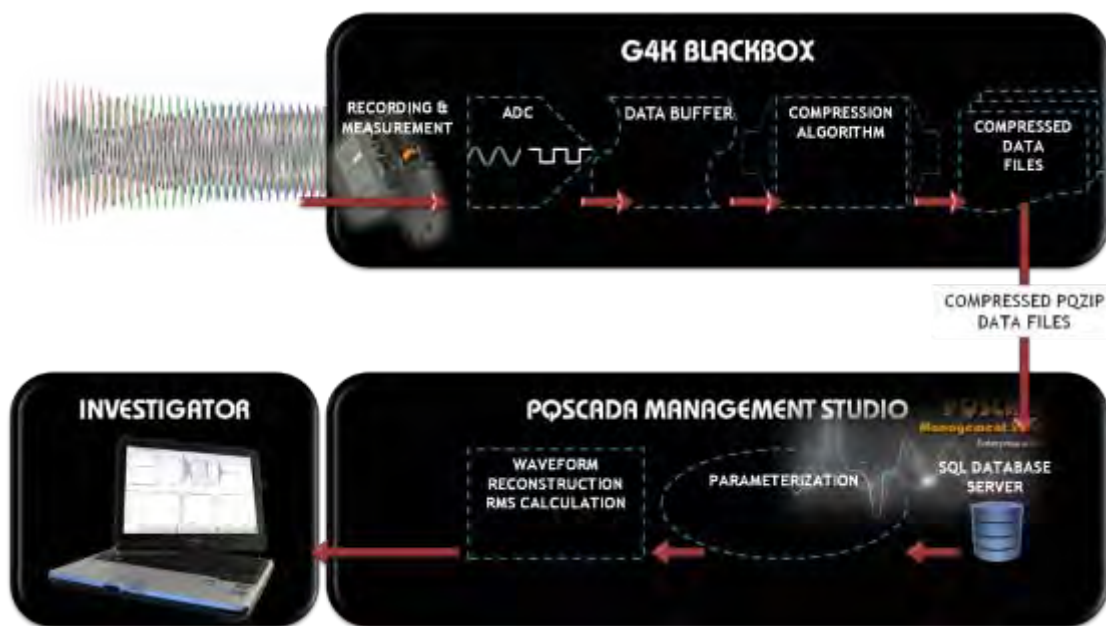

DEFINITIONS

- **Recording & Measurement:** The waveforms are being sampled at 1024 samples per cycle resolution for voltages and 256 samples per cycle resolution for currents.
- **ADC:** Voltages and currents are being converted & scaled to achieve a maximum resolution using the following Analog to Digital Conversion process.
- **Data Buffer:** The digital waveform data is buffered resulting in 512 spectral components (harmonics) per cycle for voltages and 128 for currents.
- **Compression Algorithm:** Every harmonic component is being analyzed and compressed individually. Zero value components are skipped. Non-zero harmonic components are evaluated over time & only changes in a value or angle are processed. Resulting in storage of complete & precise data over extended periods of time.

- **Compressed Data Files:** The compressed harmonic data is being organized in blocks of up to 5 minutes of concurrent cycles and being stored along with the measured frequency of every cycle and reference time stamps into a PQZIP file residing on the onboard flash memory. The typical compression ratio expected as a ratio between incoming data volume on block 3 and the data being stored is 1000:1.
- **Compressed PQZIP Data File Transferral:** The PQZIP files can be downloaded automatically or manually over a number of communication gateways for further storage and analysis.
- **SQL Database Server:** The resulting data is stored in the SQL database for long term storage. The compressed data is then reorganized and optimized for fast access while in a compressed state.
- **Parameterization:** When required, the data is decompressed, recovering a full spectrum of all the electrical parameters for each cycle, at the associated time stamps.
- **Waveform Reconstruction RMS Calculation:** The spectral data can further be used to reconstruct waveforms for any individual cycle at an extremely high resolution with accurate time and cycle duration. Any possible electrical parameters can be calculated based on the data by retrieving precise accuracy and wave shape.
- **Investigator:** The waveform displayed by the Investigator application is reconstructed based on compressed spectral data of every concurrent network cycle. In addition, virtually any electrical parameter can be calculated based on that data and displayed at any resolution or time span.

SEE ALSO

- [Default Settings](#)
- [PQZIP Recording - Configuration](#)
- [Enabling / Disabling PQZIP](#)
- [FIFO](#)
- [Fixed Quality vs. Fixed Ratio](#)
- [File Capacity](#)
- [FFT Mode](#)
- [Erase All PQZIP Data](#)

Default Settings

All G4K BLACKBOX Units leave the factory with PQZIP recording being Disabled (Off). The instrument does not start recording until [PQZIP is Enabled](#). When you access your unit for the first time, the Summary in Elspec's Web Interface will display the default settings:

RO ■ MONITORING » SUMMARY

PQZip OFF

SEE ALSO

- [PQZIP Recording - Principle](#)
- [PQZIP Recording - Configuration](#)
- [Enabling / Disabling PQZIP](#)
- [FIFO](#)
- [Fixed Quality vs. Fixed Ratio](#)
- [File Capacity](#)
- [FFT Mode](#)
- [Erase All PQZIP Data](#)

PQZIP Recording - Configuration

The window for PQZIP Configuration & Status is located on the PQZIP Recording Window. In this window you will be able to:

- [Enable / Disable the PQZIP](#)
- [Understand how the disc space is managed with the FIFO concept](#)
- [Configure either Fixed Quality / Fixed Ratio](#)
- [Configure the Time for Compression with File Capacity](#)
- [Set FFT Mode Calculation](#)
- [How to Erase All PQZIP Data](#)

OPEN THE PQZIP RECORDING WINDOW

- Access G4K's PQZIP Configuration via Elspec's Web Interface → log on as the Viewer/Administrator → select the Configuration Tab
- Under Advanced select the PQZIP Recording Tab:

CONFIGURATION	
Device Setup	Advanced
Device Info	System Log
Time	Custom Events
Voltages & Frequency	<u>PQZIP Recording</u>
Currents	E-mail Alerts
Communication	Reports
Security	Energy Meter
Network	Display Setup
Serial Ports	Firmware Upgrade
PQ Compliance	
Power Compliance	
User Defined Page 1	
User Defined page 2	
User Defined page 3	

- The PQZIP Status & Configuration Window will now open:

PQZIP Information	
Compression	97.999 %
Start Time	26/05/2011 06:35:50 UTC
Filename	FF_06C9ED_20110705_060419_940_310_2.PQZip

Compact Flash information	
Free CF Space	31.9 MBytes
Total CF Space	8025.1 MBytes

PQZip Configuration	
PQZip Mode	Quality Thresholds (%)
Fixed Quality	V 0.1 I 0.1
File Capacity	Record Mode
5 min	FULL
FFT Mode	
V:512 I:128	

Tolerance (%)	
V ₁	1.7090
V ₂	1.7334
V ₃	1.7334
V _N	0.0977
I ₁	0.8301
I ₂	0.0977
I ₃	0.5615
I _N	0.0732

STATUS SECTION

The Status Section of the PQZIP Recording Window is divided into three sections:

- PQZIP Information:

PQZIP Information	
Compression	97.999 %
Start Time	26/05/2011 06:35:50 UTC
Filename	FF_06C9ED_20110705_060419_940_310_2.PQZip

- Compression %: % O f da ta compressed f or c onfigured pe riod on successful completion of previous compression
 - Start Time: Time w hen d ata c ompression s tarted (according t o configuration)
 - File Name: Name under which the file for this session will be saved - this is important for future reference
- Compact Flash Information:

Compact Flash information	
Free CF Space	31.9 MBytes
Total CF Space	8025.1 MBytes

- Free CF Space: Free internal memory space of your G4K unit
- Total CF Space: Total memory capacity of your G4K unit
- Tolerance %;

Tolerance (%)	
V_1	1.7090
V_2	1.7334
V_3	1.7334
V_N	0.0977
I_1	0.8301
I_2	0.0977
I_3	0.5615
I_N	0.0732

The tolerance value is calculated in % to the [Nominal Configuration](#) for the specific channel.

CONFIGURATION SECTION

In this section you will be able to configure the PQZIP Recording:

PQZip Configuration		
PQZip Mode	Quality Thresholds (%)	
Fixed Quality ▾	V <input type="text" value="0.1"/>	I <input type="text" value="0.1"/>
File Capacity	Record Mode	FFT Mode
5 min ▾	FULL ▾	V:512 I:128 ▾

- To apply your changes select [Apply Changes](#)

NOTE NOTE NOTE

- If you are not logged on as the Administrator, you will not be able to change any of these settings & you will receive the following error message in your attempt to do so:

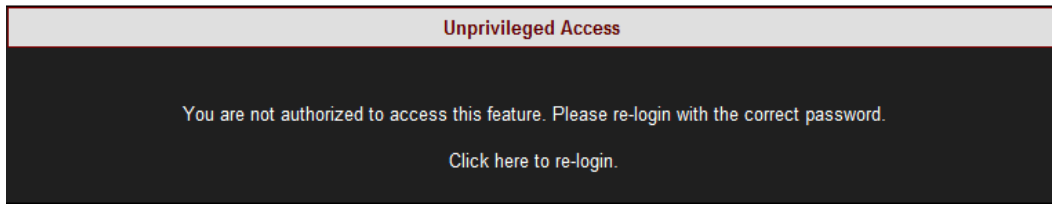

- Once you have signed on at the Administrator ensure that you select [Apply Changes](#) to actually affect your changes.

SEE ALSO

- [PQZIP Recording - Principle](#)
- [Default Settings](#)

Enabling / Disabling PQZIP

As mentioned previously, your G4K Unit arrives from the factory with PQZIP recording Disabled. Initiating Enable will prompt your G4K BLA CKBOX to commence recording and Disable will cause your device to cease recording.

HOW TO ENABLE & DISABLE PQZIP RECORDING

- Access G4K PQZIP Configuration via the [PQZIP Recording Tab](#)
- In the State drop-down selection select Enable:

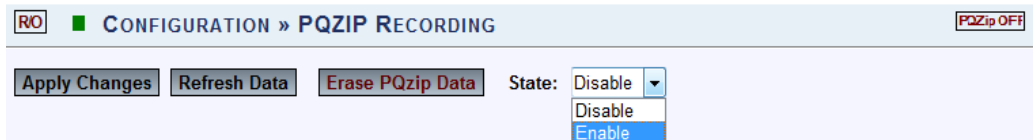

- To apply your changes select **Apply Changes**

NOTE NOTE NOTE

- Once you have enabled the PQZIP recording, the PQZip OFF Icon will no longer appear on the right-hand side on this & any other screen:



- The following warning may appear if some parameter readings are inconsistent with the configuration. In this case make sure all parameters are correct before enabling the PQZIP:

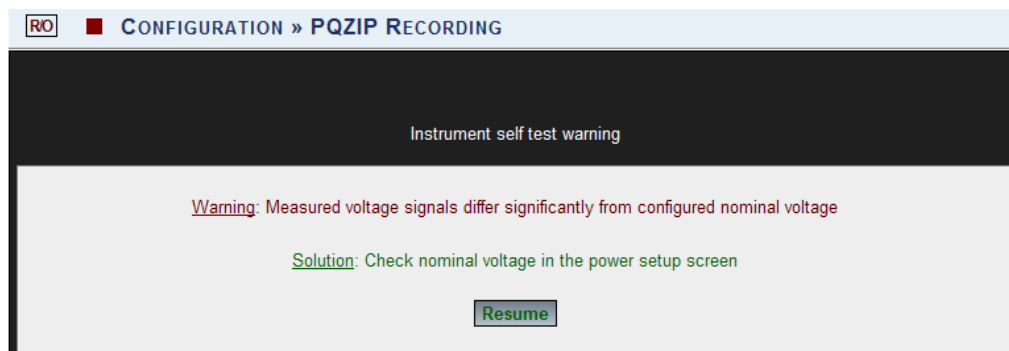

- Confirm by selecting **Resume** & the following success message will appear:

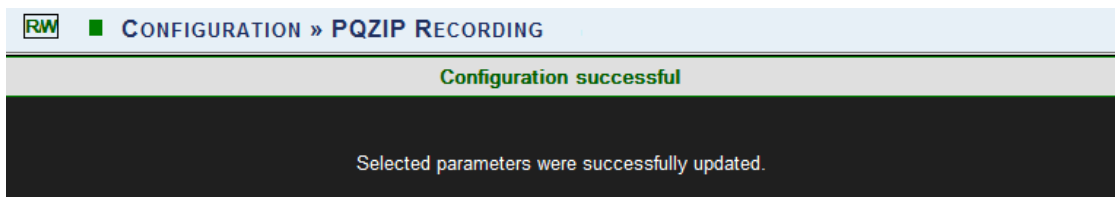

- To view your changes (refresh your current view) select **Refresh Data**

NOTE NOTE NOTE

- If you are not logged on as the Administrator, you will not be able to change any of these settings & you will receive the following error message in your attempt to do so:

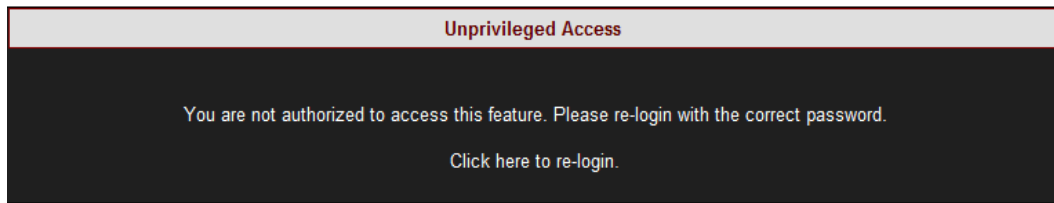

- Once you have signed on as the Administrator ensure that you select [Apply Changes](#) to actually affect your changes.

SEE ALSO

- [PQZIP Recording - Principle](#)
- [Default Settings](#)
- [PQZIP Recording - Configuration](#)
- [FIFO](#)
- [Fixed Quality vs. Fixed Ratio](#)
- [File Capacity](#)
- [FFT Mode](#)
- [Erase All PQZIP Data](#)

FIFO

PQZIP files are maintained on the G4K's Built-In Flash Memory based on the FIFO (First In First Out) concept. The G4K unit continuously records & measures all electrical information, and therefore file storage operations never stop. As such, when the on-board memory becomes full, the oldest files are deleted automatically to free required space for the newest data. However, the [PQZIP compression](#) itself allows for the storage of a 1000 times more information than typical formats & in addition the G4K BLACKBOX Device series is equipped with substantial memory capacity (G4410 - 128MB; G4420-4GB & G4430-16GB). This dramatically increases storage capacity and, thus, the G4430 is capable of recording and storing all electrical wave forms, all the time, for more than a year.

Additionally by simply downloading the files from the Incoming Folder using PQSCADA / FTP, data can be stored outside the G4K's on-board memory up to your Network Server's capacity.

SEE ALSO

- [PQZIP Recording - Principle](#)
- [Default Settings](#)
- [PQZIP Recording - Configuration](#)
- [Enabling / Disabling PQZIP](#)
- [Fixed Quality vs. Fixed Ratio](#)
- [File Capacity](#)
- [FFT Mode](#)
- [Erase All PQZIP Data](#)

Fixed Quality vs. Fixed Ratio

The most important parameter defining the actual compression ratio, (which determines the amount of storage required and maximum time continuous data can be stored) is a PQZIP Threshold value or Tolerance as it referred on the WEB page. The Tolerance defines what change in an individual harmonic would be defined as significant enough to be stored and reproduced afterwards.

The tolerance value is calculated in percentage to the [Nominal Configuration](#) for the specific channel. It is assumed that changes within 0.1% of nominal would have no importance in further power quality investigation, and the values within that range are averaged to store the representative value only. The basic and factory default tolerance value is normally defined as 0.1%. However, on some sites/networks that value can still be considered too low, for example, a highly fluctuating load or voltage lines. It is most likely that a user would prefer increasing a tolerance value for currents or voltages or even both in order to achieve better compression ratios on highly polluted network locations. To set the tolerance values see [PQZIP Recording - Configuration](#).

CONFIGURING FIXED RATIO

The G4K BLACKBOX provides the possibility of automatic adjustment of the actual tolerance value presuming a compression ratio defined as amount of data being stored per month. This option is called Fixed Ratio. When selected, the user is requested to define the amount of data to be stored per month (Monthly Ratio) in MB. Usually, slight voltage spectral changes have higher importance than current changes. Therefore, the amount of data which could be stored for voltages may be determined as greater than for currents. The V/I Relation parameter defines the relationship between the data (a part of the Monthly Ratio) reserved for voltage. If the voltage portion is larger than that for currents, the system will define a tighter tolerance for voltages than for currents.

- Access G4K PQZIP Configuration via the [PQZIP Recording Tab](#)
- In the PQZIP Configuration section, go to the PQZIP Mode & from the drop-down selection select Fixed Ratio:

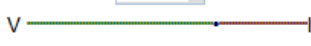
PQzip Mode	Monthly Ratio	V/I Relation (%)
<input type="text" value="Fixed Ratio"/>	<input type="text" value="700"/> MB	<input type="text" value="66"/> V 

- Define the amount of data stored per month, by entering the MB Value in the Monthly Ratio text box
- Set the appropriate V/I Relation value with the 

- To apply your changes select [Apply Changes](#)
- You will receive the following success message:

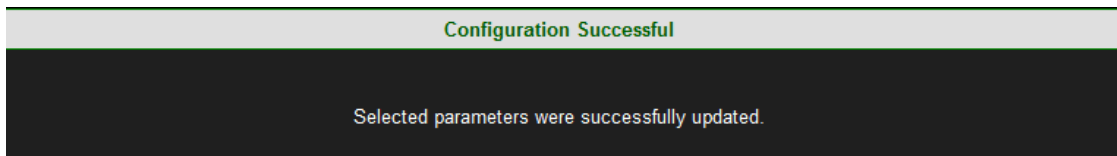

- To view your changes (refresh your current view) select [Refresh Data](#)

CONFIGURING FIXED QUALITY

With the Fixed Quality option you are able to define & fix the tolerance values for both voltages and currents as per your preferred value. This means that data will be stored at the same tolerance/quality at all times.

- Access G4K PQZIP Configuration via the [PQZIP Recording Tab](#)
- In the PQZIP Configuration section, go to the PQZIP Mode & from the drop-down selection select Fixed Quality:

PQZip Configuration	
PQZip Mode	Quality Thresholds (%)
Fixed Quality ▾	V <input type="text" value="0.1"/> I <input type="text" value="0.1"/>
Fixed Quality	
Fixed Ratio	

- Define the fixed tolerance values for both Voltage & Current by entering the Threshold % in the respective Quality Threshold % text box. REMINDER: The tolerance value is calculated in percentage to the [Nominal Configuration](#) for the specific channel.
- To apply your changes select [Apply Changes](#)
- You will receive the following success message:

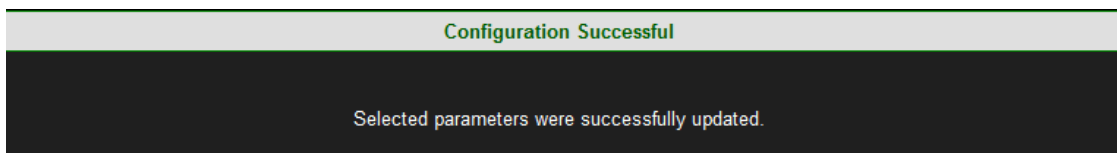

- To view your changes (refresh your current view) select [Refresh Data](#)

NOTE NOTE NOTE

- If you are not logged on as the Administrator, you will not be able to change any of these settings & you will receive the following error message in your attempt to do so:

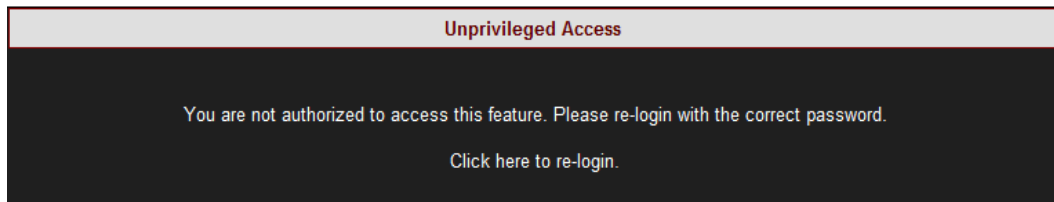

- Once you have signed on as the Administrator ensure that you select [Apply Changes](#) to actually affect your changes.
- Setting thresholds to 0 creates large amounts of data that can fill up all available disk space. This should only be done when investigating localized faults for brief periods of time.

SEE ALSO

- [PQZIP Recording - Principle](#)
- [Default Settings](#)
- [PQZIP Recording - Configuration](#)
- [Enabling / Disabling PQZIP](#)
- [FIFO](#)
- [File Capacity](#)
- [FFT Mode](#)
- [Erase All PQZIP Data](#)

File Capacity

The File Capacity parameter is used to define the maximum time each PQZIP file will take to compress. The file can be downloaded and data can be analyzed only when the file is closed, so if you expect to monitor the data in the Investigator application shortly after the data is being collected, you should choose low time durations. For all other cases, longer durations are recommended so compression ratios can be slightly improved.

CONFIGURING THE FILE CAPACITY PARAMETER

- Access G4K PQZIP Configuration via the [PQZIP Recording Tab](#)
- In the PQZIP Configuration section, go to the File Capacity & from the drop-down selection select the applicable Time Period:

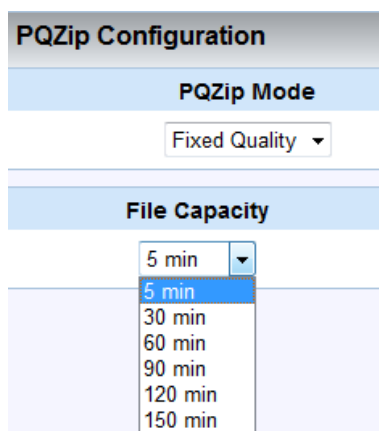

The screenshot shows the 'PQZip Configuration' window. Under the 'PQZip Mode' section, 'Fixed Quality' is selected. In the 'File Capacity' section, a dropdown menu is open, showing options: 5 min, 30 min, 60 min, 90 min, 120 min, and 150 min. The '5 min' option is currently selected.

- To apply your changes select [Apply Changes](#)
- You will receive the following success message:

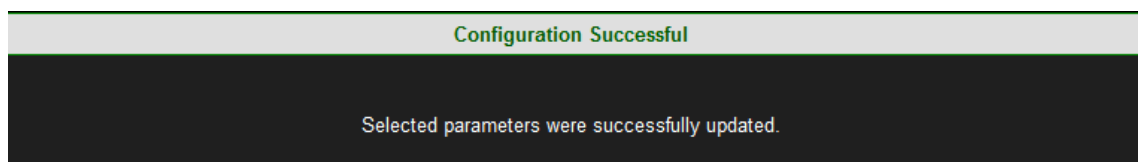

- To view your changes (refresh your current view) select [Refresh Data](#)

NOTE NOTE NOTE

- If you are not logged on as the Administrator, you will not be able to change any of these settings & you will receive the following error message in your attempt to do so:

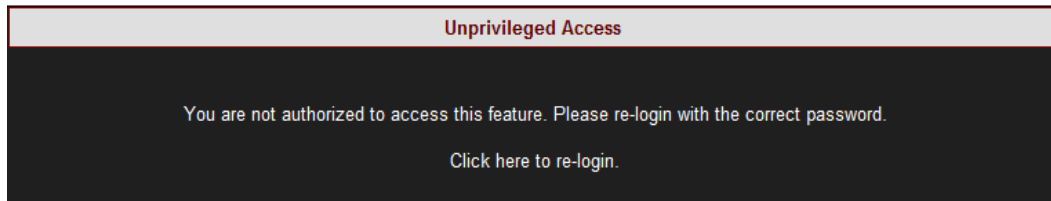

- Once you have signed on as the Administrator ensure that you select **Apply Changes** to actually affect your changes.

SEE ALSO

- [PQZIP Recording - Principle](#)
- [Default Settings](#)
- [PQZIP Recording - Configuration](#)
- [Enabling / Disabling PQZIP](#)
- [FIFO](#)
- [Fixed Quality vs. Fixed Ratio](#)
- [FFT Mode](#)
- [Erase All PQZIP Data](#)

FFT Mode

The FFT Mode is a built-in capability applicable only to the G4430 BLACKBOX. The sampling rate for the G4430 is 1,024 samples per cycle for Voltage & 256 samples per cycle for Current. Or alternatively, the sampling rate may be switched to 512 samples per cycle for Voltage & 512 samples per cycle for Current.

CONFIGURING THE FFT MODE

- Access G4K PQZIP Configuration via the [PQZIP Recording Tab](#)
- In the PQZIP Configuration section, go to the FFT Mode & from the drop-down selection select the applicable Ratio:

PQZip Configuration		
PQZip Mode	Quality Thresholds (%)	
Fixed Quality ▾	V 0.1	I 0.1
File Capacity	Record Mode	FFT Mode
5 min ▾	FULL ▾	V:512 I:128 ▾
		V:512 I:128
		V:256 I:256

Select:

- File Capacity: Used for setting compression at every: 5 min; 30min; 60min; 90min; 120min & 150min (Increased frequency will produce more files - therefore set the frequency according to your network capacity)
- FFT Mode: The sampling rate setting reflected from the drop down selection is half of the actual sampling rate - V:512 I:128 & V:256 I:256. To set your sampling rate select:
 - V:512 I:128 for actual 1,024 (Voltage) & 256 (Current) samples per cycle
 - V:256 I:256 for actual 512 (Voltage) & 512 (Current) samples per cycle
- To apply your changes select [Apply Changes](#)
- You will receive the following success message:

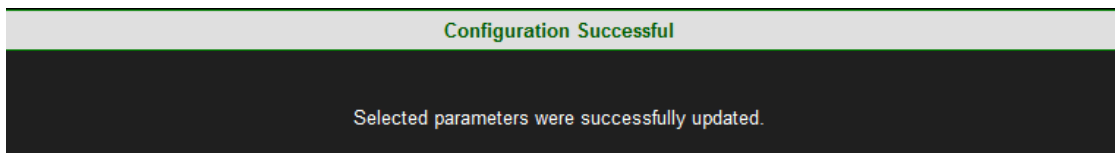

- To view your changes (refresh your current view) select [Refresh Data](#)

NOTE NOTE NOTE

- If you are not logged on as the Administrator, you will not be able to change any of these settings & you will receive the following error message in your attempt to do so:

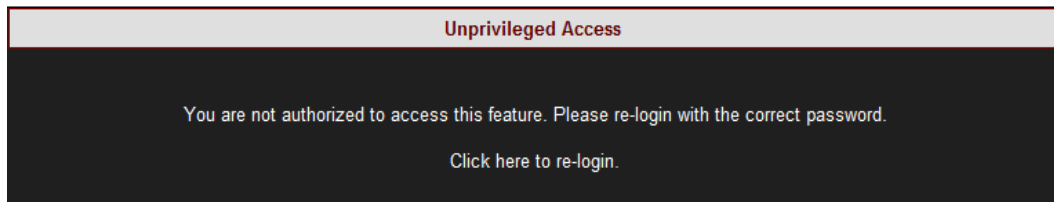

- Once you have signed on as the Administrator ensure that you select [Apply Changes](#) to actually affect your changes.

SEE ALSO

- [PQZIP Recording - Principle](#)
- [Default Settings](#)
- [PQZIP Recording - Configuration](#)
- [Enabling / Disabling PQZIP](#)
- [FIFO](#)
- [Fixed Quality vs. Fixed Ratio](#)
- [File Capacity](#)
- [Erase All PQZIP Data](#)

Erase All PQZIP Data

This function will allow you to delete all the PQZIP files from your G4K BLACKBOX's internal CompactFlash Memory. Prior to proceeding ensure that you've downloaded all the PQZIP files you needed from your G4K unit, as the procedure cannot be reversed.

ERASE PQZIP DATA

- Access G4K PQZIP Configuration via the [PQZIP Recording Tab](#)
- Select **Erase PQzip Data** & you will receive the following message:

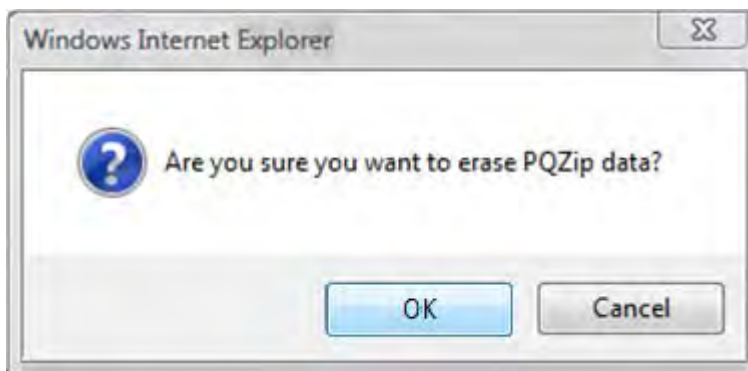

- To apply your changes select **OK** → **Apply Changes**
- You will receive the following success message:

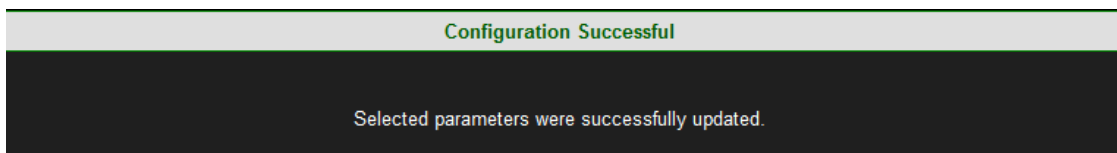

- To view your changes (refresh your current view) select **Refresh Data**

NOTE NOTE NOTE

- If you are not logged on as the Administrator, you will not be able to change any of these settings & you will receive the following error message in your attempt to do so:

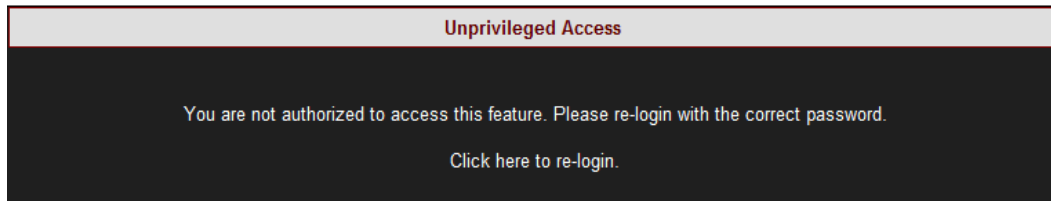

- Once you have signed on as the Administrator ensure that you select **Apply Changes** to actually affect your changes.

SEE ALSO

- [PQZIP Recording - Principle](#)
- [Default Settings](#)
- [PQZIP Recording - Configuration](#)
- [Enabling / Disabling PQZIP](#)
- [FIFO](#)
- [Fixed Quality vs. Fixed Ratio](#)
- [File Capacity](#)
- [FFT Mode](#)

About Energy

Energy is defined as power consumed over time. In electrical distribution systems, the unit of time is one hour for all energy measurements and the kWh is the basis for payment for buying and selling energy.

The Energy section focuses on the flow of energy or power both within a system (active, reactive) as well as the flow of power to and from the system to the grid (delivered or received). In this section you will be able to:

- [Review the overall Consumption & Demand of your Electrical System](#)
- [View a Detailed Breakdown of Energy Flow Components](#)
- [Review Statistical Information Regarding Measurement Status](#)

Consumption & Demand

Energy is produced and consumed within an electrical distribution system. Some sites produce energy for the grid (Received Energy), others consume energy from the grid (Delivered Energy), and still others both consume and produce energy for/from the grid. The Net Consumption is the difference between energy that is used and produced. Therefore, a negative value for Net Consumption indicates that the site is producing more than it is consuming, or a received net consumption.

The Consumption & Demand window is a quick look at some of the key components of the [Detailed Information](#) window. Here you find a cross-sectional summary view of the amount and makeup (Active or Reactive) of the Net Energy (Received - Delivered) produced/consumed by a site.

A Demand is an arbitrary measurement of average power usage per configured unit time. A demand is measured in units of power even though a time element does exist, while Peak Demand is the highest demand calculated since the last demand reset. Refer to [Energy Meter](#) in the Advanced Settings section to reset the demand of your energy meter.

ACCESS GENERAL INFORMATION REGARDING CONSUMPTION & DEMAND

- [Access your G4K Unit](#) → log on as the Viewer/Administrator → under Energy → open the Consumption & Demand Tab:

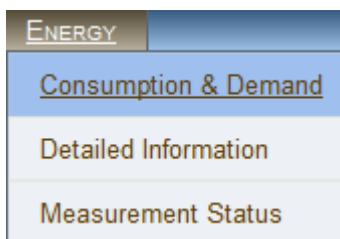

- The Consumption & Demand window will now open:

Consumption & Demand			
	Net Consumption	Demand	Peak Demand
Active Energy	42.822 kWh	0.0000 kW	4.5549 kW
Reactive Energy	-1.4878 kVAh	0.0000 kVA	-1.8135 kVA
Apparent Energy	43.248 kVAh	0.0000 kVA	4.5590 kVA

Included in this window are commonly used terms in describing energy flow within a system:

- **Active Energy (Real Energy):** The portion of power flow that, averaged over a complete cycle of the AC waveform, results in the net transfer of energy in one direction expressed as kWh
- **Reactive /Volt Amperes Reactive Energy (kVAh):** Energy that flows back and forth with no actual power flow. Reactive power flow transfers no net energy to the load and is sometimes referred to as Wattless power
- **Apparent:** The combination of active and reactive energy (kVAh)
- The corresponding Blue & Green sections will be displayed in more detail in the [Detailed Information](#) window.

SEE ALSO

- [About Energy](#)
- [Detailed Information](#)
- [Measurement Status](#)

Detailed Information

For a detailed breakdown of energy flow components, the Detailed Information window presents all the Active & Reactive values individually for both produced and consumed (Received or Delivered) energy. In addition the Net Difference (Net Energy) as well as the Sum Total (Total Energy) computations are included within this window. The Total Energy Computation Section contains the combined figure for Received & Delivered Energy.

As previously stated, the [Consumption & Demand \(Summary\)](#) window is extracted from the Details window. The corresponding values are indicated in Blue & Green in the Detailed Information Window below.

ACCESS GENERAL INFORMATION REGARDING CONSUMPTION & DEMAND

- [Access your G4K Unit](#) → log on as the Viewer/Administrator → under Energy → open the Detailed Information Tab:

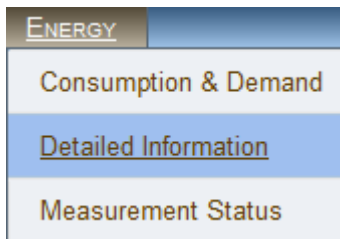

- The Detailed Information window on energy flow components will now open:

Consumption & Demand

	Net Consumption	Demand	Peak Demand
Active Energy	42.822 kWh	0.0000 kW	4.5549 kW
Reactive Energy	-1.4878 kVAh	0.0000 kVA	-1.8135 kVA
Apparent Energy	43.248 kVAh	0.0000 kVA	4.5550 kVA

Received Energy

	Current Period	Total Consumption	Demand	Peak Demand
Active Energy	0.0000 kWh	42.825 kWh	0.0000 kW	4.5650 kW
Reactive Energy	0.0000 kVAh	0.0755 kVAh	0.0000 kVA	0.0299 kVA

Delivered Energy

	Current Period	Total Consumption	Demand	Peak Demand
Active Energy	0.0000 kWh	0.0031 kWh	0.0000 kW	0.0102 kW
Reactive Energy	0.0000 kVAh	1.5633 kVAh	0.0000 kVA	1.8433 kVA

Net Energy (Received-Delivered)

	Current Period	Total Consumption	Demand	Peak Demand
Active Energy	0.0000 kWh	42.822 kWh	0.0000 kW	4.5549 kW
Reactive Energy	0.0000 kVAh	-1.4878 kVAh	0.0000 kVA	-1.8135 kVA

Total Energy (Received+Delivered)

	Current Period	Total Consumption	Demand	Peak Demand
Active Energy	0.0000 kWh	42.829 kWh	0.0000 kW	4.5752 kW
Reactive Energy	0.0000 kVAh	1.5388 kVAh	0.0000 kVA	1.8732 kVA
Apparent Energy	0.0000 kVAh	43.248 kVAh	0.0000 kVA	4.5590 kVA

SEE ALSO

- [About Energy](#)
- [Consumption & Demand](#)
- [Measurement Status](#)

Measurement Status

The Measurement Status window provides additional statistical information & necessary context on energy. The parameters & counters on this window are configured in [Energy Meter](#) in the Advanced Settings Section, which is directly accessible by selecting the [Configure energy & Demand](#) button.

ACCESS THE MEASUREMENT STATUS WINDOW

- [Access your G4K Unit](#) → log on as the Viewer/Administrator → under Energy → open the Measurement Status Tab:

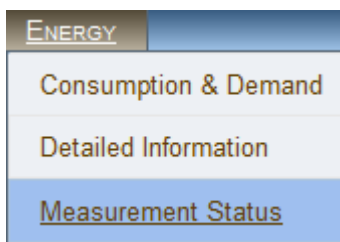

- The Measurement Status window will now open:

Status Summary	
Started	09/05/1972 21:23:24 UTC
Last Start	07/07/2011 16:15:32 UTC
Up Time	14311:10:53:59 D:H:M:S
Down Time	1:21:57:21 D:H:M:S
Availability	99.986618 %
Energy Interval	1 min
External Sync	Disable
Sliding Window	Enable

Included in this window are the following terms:

- Started: This is the date & time stamp when the [Energy Meter](#) was originally activated for the very first time
- Last Start: This is the date and time stamp for the last metering reset - [Total Consumption is Reset](#)

- **Up Time:** The total cumulative time the mechanism has been operational during the current period (since last start)
- **Down Time:** The total cumulative time the mechanism has not been operational during the current period
- **Availability:** The percentage of time the system has been operational - this is important because if this time exceeds a certain threshold, the data may not be considered reliable
- **Energy (Metering) Interval:** The energy interval is the size of the window used in computing demand (e.g. 1 minute)
- **External Sync:** This function is currently fixed in disable mode
- **Sliding Window (Accessed by selecting [Configure energy & Demand](#) in [Energy Meter](#)):** Information regarding the demand averaging system in use:
 - **Enable:** The energy is calculated using a sliding window. The figure below illustrates the time increment as 1 second:

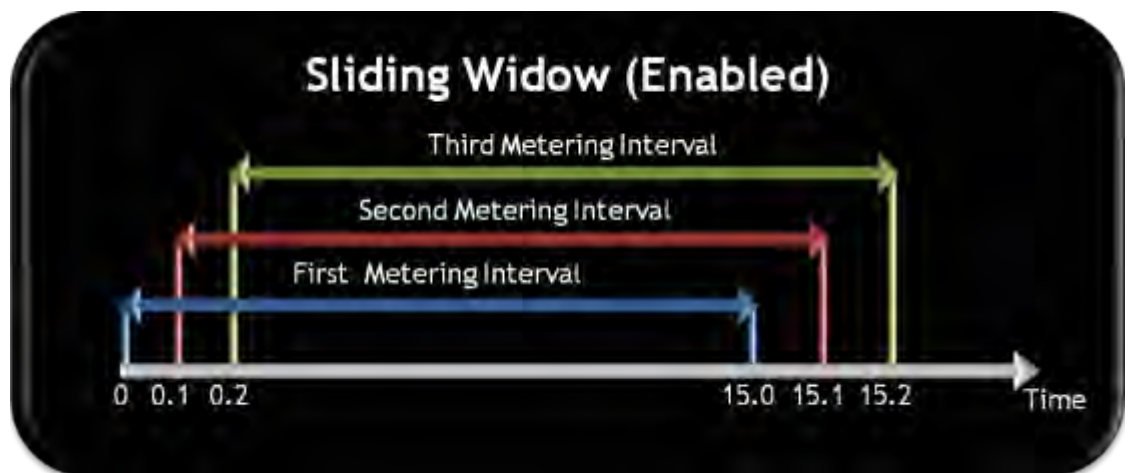

- **Disable:** The energy is calculated using fixed interval for each meter - illustration:

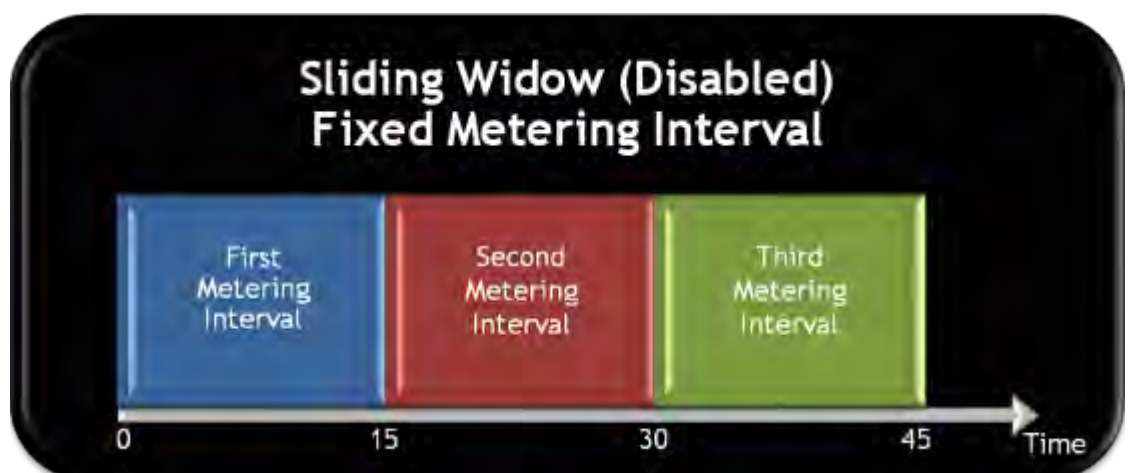

SEE ALSO

- [About Energy](#)
- [Consumption & Demand](#)
- [Detailed Information](#)

About Instrument Settings

After initial [Communication has been Established](#) & you have been successful in [Connecting to the Device for the 1st Time](#), you will need to configure your G4K device itself in Elspec's Web Interface. The procedure will demonstrate how to:

- [Setup the Device](#)
- [Configure all Communication Settings](#)
- [Configure the PQ Settings](#)
- [Configure User Defined Pages](#)

Device Setup

Configuration of your G4K device itself occurs in Elspec's Web Interface on successful [Connection to the Device](#).

- [Access](#) your device via Elspec's Search Utility through the Web (Identifiable either by the [Serial Number](#) / indicated in green as a [New Device](#)):

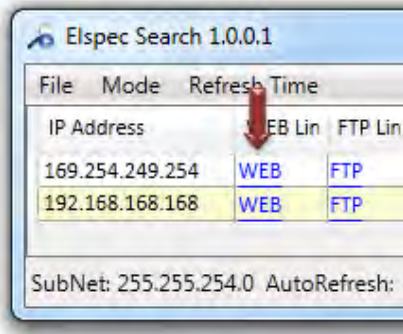

File	Mode	Refresh	Time
IP Address		WEB Lin	FTP Lin
169.254.249.254		WEB	FTP
192.168.168.168		WEB	FTP

SubNet: 255.255.254.0 AutoRefresh: 1

- Select the Web link for your device, Elspec's Web Interface will now open:



- In order to view the different languages in the Web Interface, you will need to upload the language feature from [Elspec's Website](#) when installing your new Firmware. Once uploaded, simply select the applicable interface language from the drop-down list:

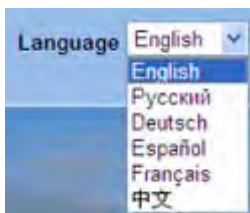

- The supported languages are:
 - English (Default)
 - Russian
 - German
 - Spanish
 - French
 - Chinese

(For other languages - please contact your local Elspec distributor)

- The Password field defines user level/privileges. The user levels are Viewer / Administrator (See [Security Settings](#)). The default password including privileges for each level are:
 - Viewer is 123 (Read only, can choose interface language only, no operations related changes are allowed)
 - Administrator is 12345 (Administration, setup & full control)
- By selecting the Configuration Tab & within the Device Setup section you'll be able to:
 - [Complete the Device Info](#)
 - [Configure the Voltage & Frequency](#)
 - [Set the Time Settings](#)
 - [Configure the Currents](#)

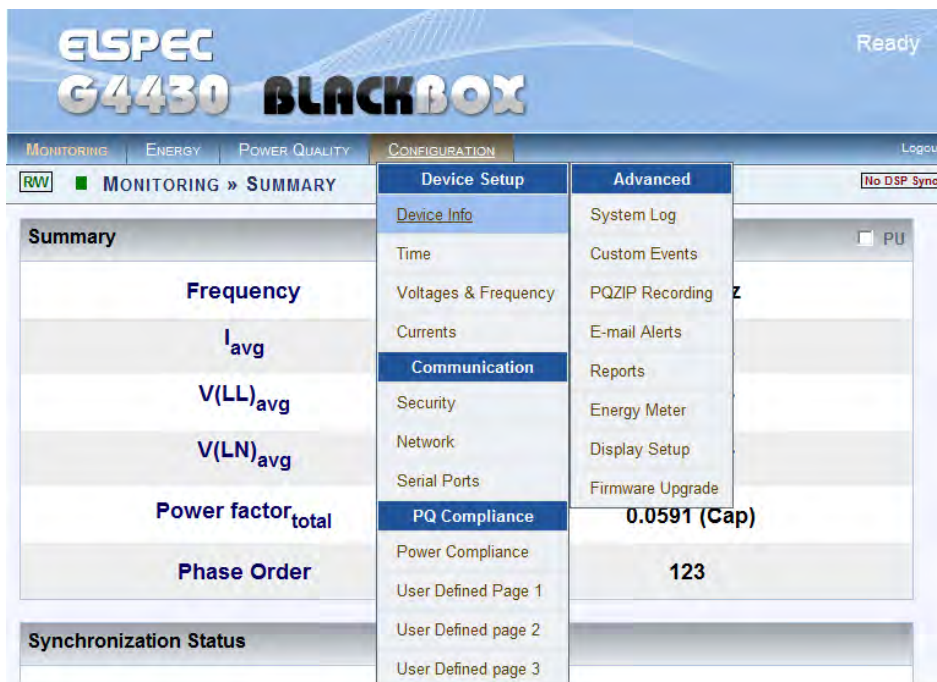

NOTE NOTE NOTE

- The Website is optimized to work with Internet Explorer 7, 8 or 9 in "Compatibility View". Ensure that the Internet Explorer is running in Compatibility View:



- Other web browser applications can limit some functionality and/or show an incorrect layout.
- For local networking the browser should be configured as working without a proxy server. Refer to Disable Proxy Server in Internet Explorer.
- The passwords above are factory default values. You are advised to modify Admin password if extended security measures are required (See [Security Settings](#)).
- If you are not logged on as the Administrator, you will not be able to change any of these settings & you will receive the following error message in your attempt to do so:

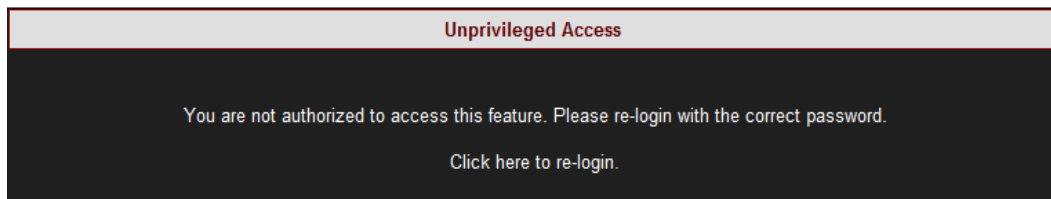

Device - Info G4K Unit Configuration

Within this window you will be able to:

- Configure your G4K Unit
- [View Hardware & Software Information for your G4K](#)
- [View all the Details Regarding Power System](#)
- [Enable/Disable the PoE Output](#)
- [Configure Alarm Settings](#)

CONFIGURE YOUR G4K UNIT

- [Access your G4K Device](#) via Elspec's Web Interface → log on as the Administrator (Manufacturer's Default Password is : 12345) → select the Configuration Tab

- Under Device Setup select the Device Info Tab:

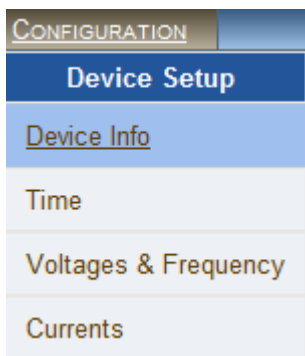

- In the G4 Unit Configuration Section complete:
 - Site Name: Enables the user to include a description of the site where the device is installed. This site description also appears in the Elspec's Search utility under Unit Description when searching for devices
 - Description: An additional text field for you to use optionally as you see fit
 - Operator: A text field for inputting the operator/technician's name
 - Company: A text field for inputting the company's name

G4 Unit Configuration	
Site Name	Elspec Site 1
Description	PQ Measurements
Operator	Elspec Admin
Company	Elspec Ltd.

- To apply your changes select **Apply Changes**
- Review your changes by selecting **Refresh Data**
- To enforce your changes to your G4K unit select **Restart Unit**
- Go on to the next step [View Product Settings](#)

NOTE NOTE NOTE

- If you are not logged on as the Administrator, you will not be able to change any of these settings & you will receive the following error message in your attempt to do so:

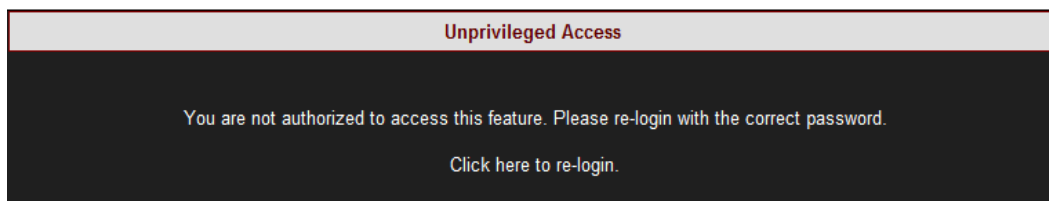

- Once you have signed on as the Administrator ensure that you select **Apply Changes** to actually affect your changes.

SEE ALSO

- [About Device Setup](#)
- [Voltage & Frequency](#)
- [Time Settings](#)
- [Currents](#)

G4K Product Attributes

The Product section specifies information regarding the G4K System Attributes (Software, Hardware):

Product	
Boot	0.2.95
Software	0.4.03.1.5800
Hardware	2x2x2
DSP	4.6

The fields specify the following internal HW and SW Versions:

- **Boot:** Displays the Boot Loader application version. The Boot Loader application is a small separated part of the BLACKBOX Firmware. The Boot is stored on a secured sector in the internal flash memory chip & is used for the HW initialization for loading Firmware upgrades and for further execution of the G4K'S Firmware. The Boot executes either Bank A or Bank B Firmware. [See Firmware Upgrade](#)
- **Software:** Displays the BLACKBOX Firmware Version is in use. [See Firmware Upgrade](#)
- **Hardware:** Displays the BLACKBOX Hardware Version of the [G4K's Modules](#)
- **DSP:** Displays the BLACKBOX DSP Version in use. The G4K is equipped with a dedicated [DSP \(Digital Signal Processing\) Module](#) for high speed calculations. This field defines the Firmware Version of the code being executed on this DSP.

SEE ALSO

- [G4K Unit Configuration](#)
- [Power Status](#)
- [PoE Output](#)
- [Alarms](#)

Power Status

Power Status	
Powered by	AC
AC	On
PoE Input	Off
DC(48v)	Off
Down	Off
Capacitors	25F

In this section you can view all the Power Status:

- Powered by: Informs the user as to the type of power currently supplying the instrument
- AC: AC status
- PoE Input: Status of the PoE on the LAN1 port; an alternate power input for the instrument
- DC (48v): Status of the [DC Power Supply Input](#)
- Down: Should this flag indicate "ON" it means that the G4K has no power supply & is on ride through power supplied by the capacitors
- Capacitors: Indicates the size of the Super Capacitor supplying the ride through power

SEE ALSO

- [G4K Unit Configuration](#)
- [G4K - Product Attributes](#)
- [PoE Output](#)
- [Alarms](#)

PoE Output

PoE Output	State: <input type="button" value="Enable"/>
PSE Status	OK
PSE Error Code	Off

- State: Allows you to Enable/Disable the PoE Output for LAN2 (See [Also Establish Communication](#))
- PSE Status: Indicates the status of the LAN2/LCD port (Ok/ Fail)
- PSE Error Code: Off signifies that this port is not in use. On signifies that an LCD screen is currently attached to this port.
- To apply your changes select → to review them
- To enforce your changes to your G4K unit select

SEE ALSO

- [G4K Unit Configuration](#)
- [G4K - Product Attributes](#)
- [Power Status](#)
- [Alarms](#)

Alarms

Alarms Configuration

<input checked="" type="checkbox"/> General	<input checked="" type="checkbox"/> DSP Sync	<input checked="" type="checkbox"/> Time Sync	<input checked="" type="checkbox"/> PQZip
<input checked="" type="checkbox"/> FTP	<input checked="" type="checkbox"/> Flash	<input checked="" type="checkbox"/> Logger	<input checked="" type="checkbox"/> DSP
<input checked="" type="checkbox"/> Drop Data	<input checked="" type="checkbox"/> Misconfigured		

A checked item that is malfunctioning causes the red alarm indicator light on the BLACKBOX unit to turn on:  & to be displayed in the [System Log](#). The table below includes the types of alarms that you may want to configure into your G4K Unit & what indication it will cover:

ALARM TYPE	INDICATION
General	General G4K startup & system initiation
SNTP	Availability of the Network connection to the SNTP server
Drop Data	Temporary loss of PQZIP data
DSP Sync	Verification unit synchronization with the network power
Flash	Success of the data transfer to the G4K's internal Flash memory
Misconfigured	Verification of configured nominal value compared with the CT/PT value
Time Sync	Verification of the quality of the time synchronization (POOR or less)
Logger	Verification of a corrupted Logger
PQZIP	Verification whether or not the PQZIP is enabled
DSP	Communication verification between CPU with DSP module

- To apply your changes select [Apply Changes](#) ➔ [Refresh Data](#) to review them
- To enforce your changes to your G4K unit select [Restart Unit](#)

SEE ALSO

- [G4K Unit Configuration](#)
- [G4K - Product Attributes](#)
- [Power Status](#)
- [PoE Output](#)

Voltage & Frequency

The Voltage & Frequency Window defines all the major configurations regarding the Voltage & Frequency values. In this window you will be able to:

- [Configure the Power](#)
- [Configure the Potential Transformation Ratio](#)
- [Smooth the curve in significant change of P Q P arameter \(IEC61000-4-7 Compliance\)](#)
- [Toggle the polarity without rewiring](#)
- [Define nominal values for Voltage & Frequency](#)

OPEN THE VOLTAGE & FREQUENCY WINDOW

- [Access](#) the G4K Device Configuration via Elspec's Web Interface → log on as the Administrator (Manufacturer's Default Password is: 12345) → select the Configuration Tab
- Under Device Setup select the Voltage & Frequency Tab:

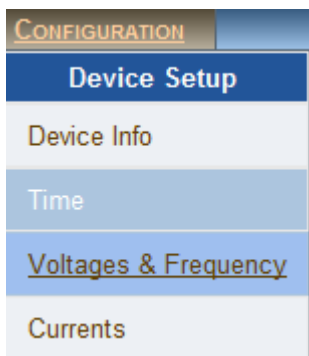

- The Voltage & Frequency Window will now open:

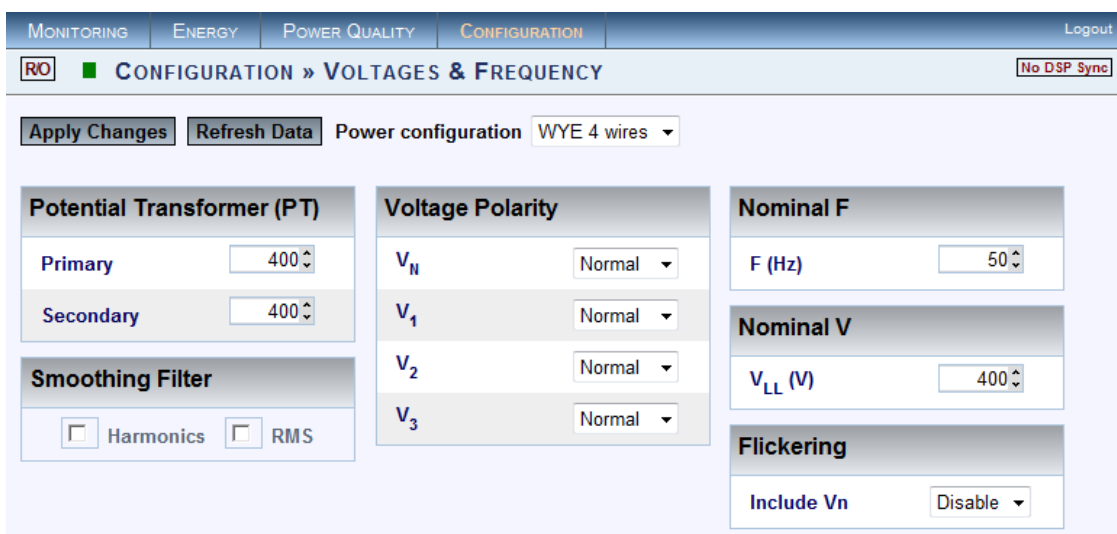

NOTE NOTE NOTE

- If you are not logged on as the Administrator, you will not be able to change any of these settings & you will receive the following error message in your attempt to do so:

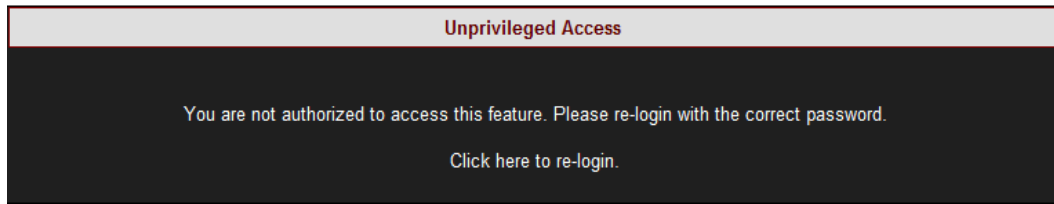

SEE ALSO

- [About Device Setup](#)
- [Device - Info G4K Unit Configuration](#)
- [Time Settings](#)
- [Currents](#)

Power Configuration

The network type settings are represented by five different configurations, although the actual number of supported networks could be extended to virtually any existing configuration. Refer to [G4K Wiring](#) in order to view the types of Power Topology the G4K supports.

- The following table outlines the recommended configurations for several supported power types:

POWER TYPE	RECOMMENDED POWER CONFIGURATION
Single Phase with Neutral	Single LN
Single Phase without Neutral	Single LL
Single Split Phase	2Phase TR
Three Wire Delta	Delta 3 Wires
Four Wire WYE	WYE 4 Wires
Three Wire WYE	WYE 4 Wires
Delta High Leg	Delta 3 Wires
Delta Open Leg	Delta 3 Wires

- Select the applicable Network Type Settings according to your network type from the drop-down selection:

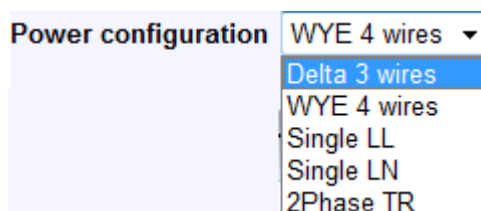

- To apply your changes select [Apply Changes](#)
- You will receive the following warning message as changing the network configuration will result in all the energy calculations to be averaged & will clear all your Custom Event configurations. Click [OK](#) in order to proceed:

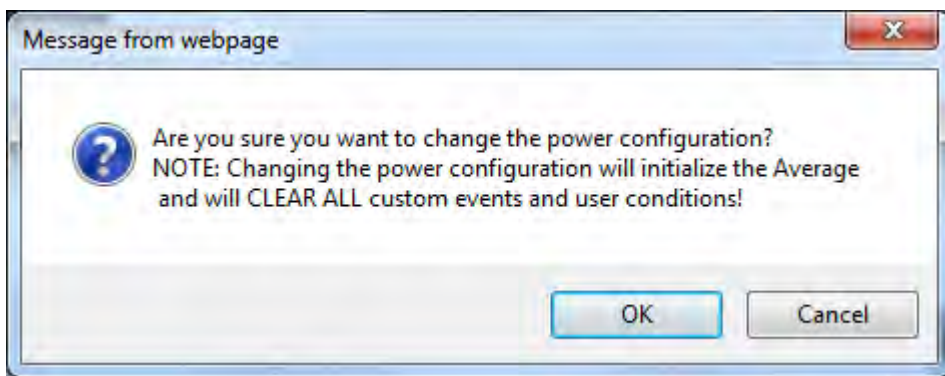

- You will receive a "Configuration Successful" message & will be prompted to initiate a restart of the energy calculations.

Click  in order to proceed:

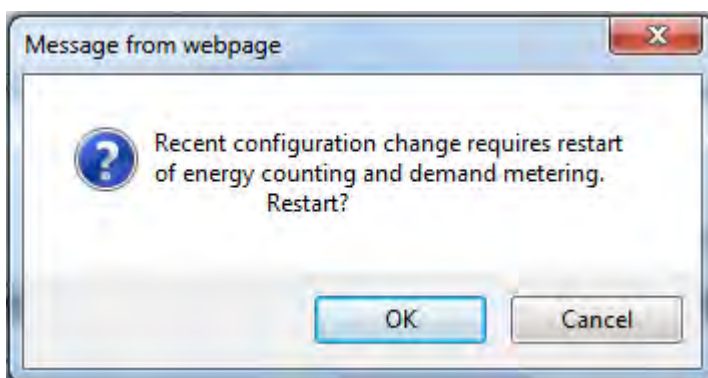

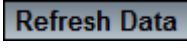
- Review your changes by selecting 

SEE ALSO

- [About Voltage & Frequency](#)
- [Potential Transformer](#)
- [Smooth Filtering](#)
- [Voltage Polarity](#)
- [Define Nominal Values](#)

Potential Transformer

Potential Transformer configuration is required only for MV/HV networks where the voltage is measured using PT's. This option allows you to accurately configure the known transformation ratio in both magnitude and phase, over a range of measuring circuit impedances. The voltage transformer is intended to present a negligible load to the supply being measured. The low secondary voltage allows protective relay equipment and measuring instruments to be operated at lower voltages.

- For MV/HV Networks (Voltage Measurements by PT's) set the correct Primary & Secondary Ratio (with ▲/▼) - according to the PT Manufacturer's Specifications & not just the Ratio:

Potential Transformer (PT)	
Primary	400 ▼
Secondary	400 ▼

If the PT Ratio is inapplicable, then set your values to read:

Primary = Secondary = Nominal

- The ratio for LV Networks is based on the same concept & specifications - Set the Primary & Secondary Ratio (with ▲/▼) (according to the PT Manufacturer's Specifications & not just the Ratio):

Potential Transformer (PT)	
Primary	5 ▼
Secondary	1 ▼

If the PT Ratio is inapplicable, then set your values to read:

Primary = Secondary = Nominal

- To apply your changes **Apply Changes** → **Refresh Data** to review them

SEE ALSO

- [About Voltage & Frequency](#)
- [Power Configuration](#)
- [Smooth Filtering](#)
- [Voltage Polarity](#)
- [Define Nominal Values](#)

Smooth Filtering

This filter is introduced according to IEC standard 61000-4-7. It allows (enabled) smoothing of the curve when there are fluctuations in a power quality parameter such as in Harmonics / RMS.

- Mark the Applicable Parameter for filtering (Harmonics & / RMS):

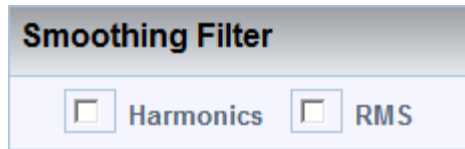

- To apply your changes select **Apply Changes** → **Refresh Data** to review them

SEE ALSO

- [About Voltage & Frequency](#)
- [Power Configuration](#)
- [Potential Transformer](#)
- [Voltage Polarity](#)
- [Define Nominal Values](#)

Voltage Polarity

Wiring errors usually result in an incorrect polarity. The Voltage Polarity settings allow you to toggle the polarity without the necessity of rewiring.

- Either Reverse the polarity / maintain it at Normal from the drop-down selection:

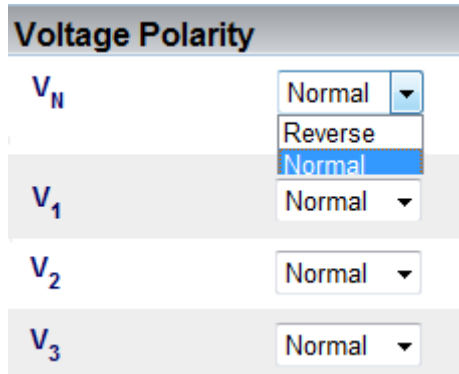

Channel	Polarity
V _H	Normal
V ₁	Normal
V ₂	Normal
V ₃	Normal

- To apply your changes select **Apply Changes** → **Refresh Data** to review them

SEE ALSO

- [About Voltage & Frequency](#)
- [Power Configuration](#)
- [Potential Transformer](#)
- [Smooth Filtering](#)
- [Define Nominal Values](#)

Define Nominal Values

The Nominal section defines the nominal values for Frequency (F) and Voltages (V). The Frequency nominal affects compliance. For example, when 50Hz nominal is set, the window is 10 cycles, and for 60Hz the window is 12 cycles.

- For HV & MV Networks, define the Nominal Values for Frequency (F) and Voltages (V) (with ▲/▼):

Nominal F	
F (Hz)	50 ▲▼

Nominal V	
V _{LL} (V)	400 ▲▼

- The ratio for LV Networks is based on the same concept & specifications - Define the Nominal Values for Frequency (F) and Voltages (V) (with ▲/▼):

Nominal F	
F (Hz)	50 ▲▼

Nominal V	
V _{LL} (V)	230 ▲▼

If the PT Ratio is inapplicable, then set your values to read:

Primary = Secondary = Nominal

- To apply your changes select **Apply Changes** → **Refresh Data** to review them

NOTE NOTE NOTE ...

- Should you enter incorrect nominal values, the device may not record anything.
- For maximum logging resolution and efficiency it is recommended keeping NOMINAL values as close to the expected normal condition values and NOT to maximum values!
- FOR NOMINAL V VALUES: If you are using a [Potential Transformer \(PT\) Configuration](#) for MV/HV networks, the Nominal V values needs to be set to the [PT values](#).

SEE ALSO

- [About Voltage & Frequency](#)
- [Power Configuration](#)
- [Potential Transformer](#)
- [Smooth Filtering](#)
- [Voltage Polarity](#)

Time Settings

The Time section is used to set and control the time. In addition it may also be used for displaying & logging of the data & events. Within this window you'll be able to:

- Control the time synchronization of external time sources with [Network Time](#)
- Set & control the internal clock of the G4K unit with [Setup the Time](#)
- Automatically adjust the G4K Unit with [Daylight Saving Time](#)

ACCESS TIME CONFIGURATION

- [Access](#) the G4K Device Configuration via Elspec's Web Interface → log on as the Administrator (Manufacturer's Default Password is: 12345) → select the Configuration Tab
- Under Device Setup select the Time Tab:

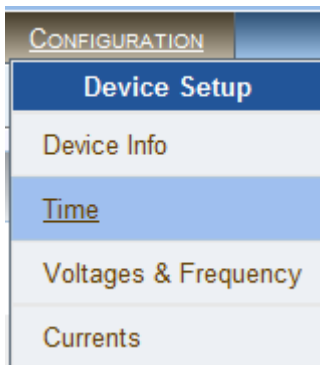

- The Time Window will now open:

The screenshot shows a web interface for configuring time settings. At the top, there is a breadcrumb 'CONFIGURATION » TIME' and a status indicator 'No DSP Sync'. Below the breadcrumb are two buttons: 'Apply Changes' and 'Refresh Data'. The main content is divided into three sections:

- Network Time:**
 - Transport: Automatic (dropdown)
 - Main SNTP: 169.169.169.169 (text input)
 - Alternate SNTP: 169.169.169.169 (text input)
 - Using SNTP: Self (dropdown)
 - Slew Mode: Automatic (dropdown)
 - Slew Factor: 50 % (text input)
 - Step Time: 10 Sec. (text input)
- Time Setup:**
 - RTC Counter: 162:22:8:15 D:H:M:S (text input)
 - Time Zone: UTC +5 (dropdown)
 - Unit Date & Time: 01/06/2011 08:00:00 (text inputs)
 - Set Date & Time (button)
- Daylight Saving:**
 - State: Enable (dropdown)
 - Start Time_{UTC}: 25/05/2011 14:41:00 (text inputs)
 - End Time_{UTC}: 31/01/2011 13:00:00 (text inputs)

NOTE NOTE NOTE

- If you are not logged on as the Administrator, you will not be able to change any of these settings & you will receive the following error message in your attempt to do so:

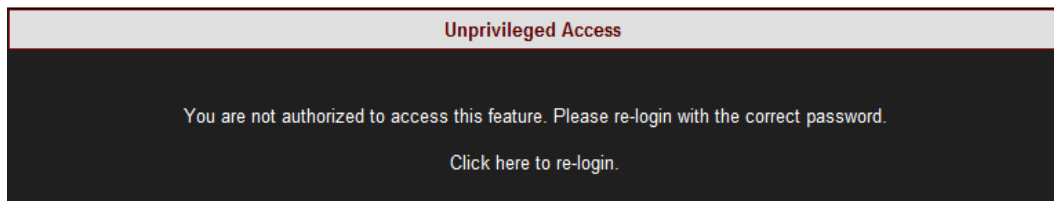

SEE ALSO

- [About Device Setup](#)
- [Device - Info G4K Unit Configuration](#)
- [Voltage & Frequency](#)
- [Currents](#)

Network Time

Network Time	
Transport	Automatic ▾
Main SNTP	169.169.169.169
Alternate SNTP	169.169.169.169
Using SNTP	Self
Slew Mode	Automatic ▾
Slew Factor	50 %
Step Time	10 Sec.

This section controls Time Synchronization with a variety of external time sources. Make your changes according to your selection:

- **Transport:** Utilize this option to force the Time Sync Module to select the source Automatically, or to force the source Manually to NTP or GPS source
- **Main SNTP:** Use this option in order to configure the IP address of the Primary SNTP server to be used
- **Alternate SNTP:** Use this option to configure the IP address of the secondary SNTP server to be used (A contingency should the Primary Server become unavailable)
- **Slew Mode:** Set the type of Time Slewing/Adjustment to be used by the Time Sync module. This will compensate for time deviations and network communication jitters. The default & preferred mode is Automatic, as the Slewing Factor is according to time source communication quality.
- To apply your changes select **Apply Changes** ➔ **Refresh Data** to review them

SEE ALSO

- [About Time Settings](#)
- [Time Setup](#)
- [Daylight Saving](#)

Time Setup

Time Setup	
RTC Counter	162:22:8:15 D:H:M:S
Time Zone	UTC +5 ▼
Unit Date & Time	<input type="text" value="01/06/2011"/> <input type="text" value="08:00:00"/>
<input type="button" value="Set Date & Time"/>	

This section is used to set and control the internal clock of the G4K Unit. Set:

- **The RTC Counter:** Is used for setting the counting of the internal real time clock. The RTC starts its counting from the date of manufacture. RTC Counter format reads as: Days, Hours, Minutes, and Seconds
- **Time Zone:** Specifies the date and time to be presented on the WEB interface (time and date are presented at the bottom of the page). The presented time is the local time derived from the GMT time and the configured Time Zone which shifts the GMT time backward or forward in accordance. (Greenwich Mean Time (GMT) means time at Greenwich, London (Also referred to as UTC)
- **Unit Date & Time:** Utilized for setting the current time & date manually. Once you click on the configuration box, the date or time will instantly appear and you can set it. Click on the Set Date & Time button and the time is changed. However, if the unit's Time Synchronization module is synchronizing with an external source (like NTP or GPS), the time will be overridden as soon as the updates are received. To prevent automatic updates, set the Time Sync module on Self synchronization.
- To apply your changes select →
- Review your changes by selecting

SEE ALSO

- [About Time Settings](#)
- [Network Time](#)
- [Daylight Saving](#)

Daylight Saving

Daylight Saving		
State	Enable ▾	
Start Time _{UTC}	25/05/2011	14:41:00
End Time _{UTC}	31/01/2011	13:00:00

You can Enable the daylight saving time (Winter / Summer Clock) feature and set the period in this section. This will cause the time to automatically adjust to daylight savings time during the pre-defined period. This information is passed to the PQSCADA together with all other information via PQZip where it is displayed to the user. To set the daylight saving time:

- Select Enable
- Enter Start / End Date & Time (UTC)
- To apply your changes select **Apply Changes** → **Refresh Data** to review them

SEE ALSO

- [About Time Settings](#)
- [Network Time](#)
- [Time Setup](#)

Currents

The Current Window defines all the Current values. In this window you will be able to:

- [Configure all the Primary & Secondary Current Transformer Values](#)
- [Define Nominal Current Values](#)
- [Toggle the Current Polarity without rewiring](#)
- [Configure Calculated Current Channels](#)

OPEN THE CURRENTS WINDOW

- [Access](#) the G4K Device Configuration via Elspec's Web Interface → log on as the Administrator (Manufacturer's Default Password is: 12345) → select the Configuration Tab
- Under Device Setup select the Currents Tab:

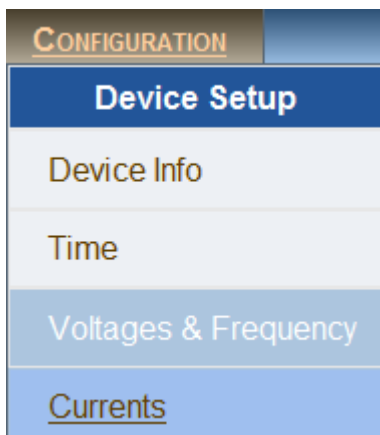

- The Currents Window will now open:

MONITORING ENERGY POWER QUALITY CONFIGURATION Logout

RO ■ CONFIGURATION » CURRENTS

Apply Changes Refresh Data

Current Transformer (CT)	Nominals	Current Polarity
I ₁ Primary 1000	I ₁ (A) 50	I _N Normal
I ₁ Secondary 5	I ₂ (A) 50	I ₁ Normal
I ₂ Primary 1000	I ₃ (A) 50	I ₂ Normal
I ₂ Secondary 5	I _N (A) 50	I ₃ Normal
I ₃ Primary 1000		
I ₃ Secondary 5		
I _N Primary 1000		
I _N Secondary 5		

Non-measured Currents

Calculated Phase All Present

NOTE NOTE NOTE

- If you are not logged on as the Administrator, you will not be able to change any of these settings & you will receive the following error message in your attempt to do so:

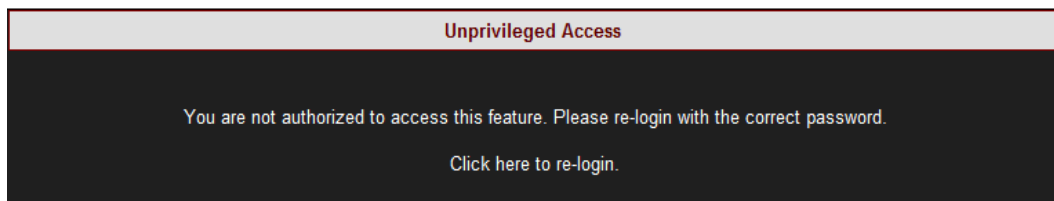

SEE ALSO

- [About Device Setup](#)
- [Device - Info G4K Unit Configuration](#)
- [Voltage & Frequency](#)
- [Time Settings](#)

Current Transformer

This option allows you to accurately configure the known Primary & Secondary Transformation Ratios for all the Current channels from I_1 to I_N :

- Set the correct Primary & Secondary Ratios (with ▲/▼):

Current Transformer (CT)	
I_1 Primary	1000 ▲▼
I_1 Secondary	5 ▲▼
I_2 Primary	1000 ▲▼
I_2 Secondary	5 ▲▼
I_3 Primary	1000 ▲▼
I_3 Secondary	5 ▲▼
I_N Primary	1000 ▲▼
I_N Secondary	5 ▲▼

If the CT Ratio is inapplicable, then set your values to read:

Primary = Secondary = Nominal

- To apply your changes select **Apply Changes** → **Refresh Data** to review them

SEE ALSO

- [About Current Window](#)
- [Nominal](#)
- [Current Polarity](#)
- [Non-Measured Currents](#)

Nominal

The Nominal section defines the nominal Ampere values for all the Current Channels from I_1 to I_N :

- Define the Nominal Values (with ▲/▼):



If the CT Ratio is inapplicable, then set your values to read:

Primary = Secondary = Nominal

- To apply your changes select [Apply Changes](#) → [Refresh Data](#) to review them

NOTE NOTE NOTE ...

For maximum logging resolution and efficiency it is recommended keeping NOMINAL values as close to the expected normal condition values and NOT to maximum values!

SEE ALSO

- [About Current Window](#)
- [Current Transformer](#)
- [Current Polarity](#)
- [Non-Measured Currents](#)

Current Polarity

The Current Polarity settings allow you to toggle the polarity values for all the Current Channels (from I_1 to I_N) without the necessity of rewiring (due to polarity errors caused by incorrect wiring).

- Either Reverse the polarity / maintain it at Normal from the drop-down selection:

Current Polarity	
I_N	Normal ▾
I_1	Normal ▾
I_2	Normal ▾
I_3	Normal ▾

- To apply your changes select **Apply Changes** → **Refresh Data** to review them

SEE ALSO

- [About Current Window](#)
- [Current Transformer](#)
- [Nominal](#)
- [Non-Measured Currents](#)

Non-Measured Currents

The Non-measured Current section helps to configure calculated current channels. There are two calculation options & they differ for:

- [WYE Network](#),
- [DELTA & Single Split Phase Network](#)

CONFIGURING CALCULATED CURRENT CHANNELS FOR WYE NETWORK

- Ensure the [Power Configuration](#) coincides with your Network
- In the Non-Measured Currents section, select the applicable phase to be calculated:

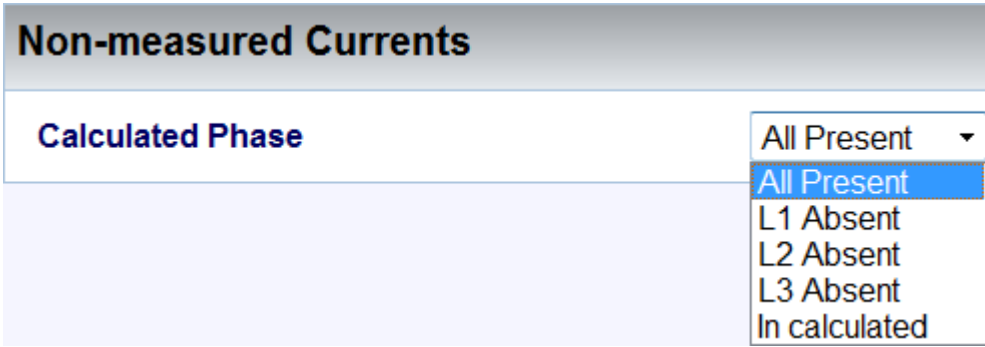

The screenshot shows a window titled "Non-measured Currents". Inside, there is a label "Calculated Phase" next to a dropdown menu. The dropdown menu is open, displaying the following options: "All Present" (selected), "L1 Absent", "L2 Absent", "L3 Absent", and "In calculated".

Calculation is based on Kirchhoff's laws - everything that comes in must go out, in order for the calculation of one of the current line to be based on the other measured lines instead of measuring it. For example when L_x is Absent it is being calculated using the other lines instead of measuring it. Or the neutral current I_N could be optionally calculated from the sum of three-phase currents, or alternatively, measured by the I_4 current channel.

CONFIGURING CALCULATED CURRENT CHANNELS FOR DELTA & SINGLE SPLIT PHASE NETWORK

- Ensure the [Power Configuration](#) coincides with your Network
- In the Non-Measured Current section, select the applicable phase to be missed:

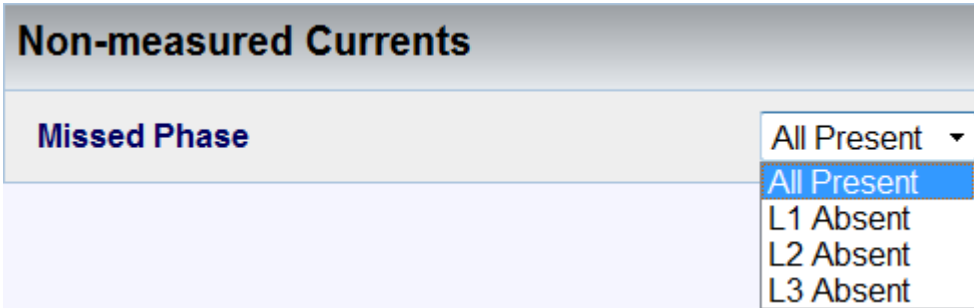

The screenshot shows a window titled "Non-measured Currents". Inside, there is a label "Missed Phase" next to a dropdown menu. The dropdown menu is open, displaying the following options: "All Present", "L1 Absent", "L2 Absent", and "L3 Absent".

One of the three-phase current channels could optionally be calculated from the $I_1 + I_2 + I_3 = 0$

SEE ALSO

- [About Current Window](#)
- [Current Transformer](#)
- [Nominal](#)
- [Current Polarity](#)

Communication Configuration

After [Communication has been Established](#) & you have been successful in [Connecting to the Device for the 1st Time](#), you will need to configure the communication settings G4K device itself in Elspec's Web Interface. The procedure includes:

- [Setting Web Entry Passwords & Providing Access to the FTP Server](#)
- [Establish the G4K device's IP in your Network](#)
- [Configure RS485/RS422 interface parameters in Serial Ports](#)

ACCESS THE G4K'S COMMUNICATION CONFIGURATIONS

- [Access](#) the G4K Device via Elspec's Web Interface → log on as the Administrator (Manufacturer's Default Password is: 12345) → select the Configuration Tab
- All the Communication Configurations are located under the Communication Tab:

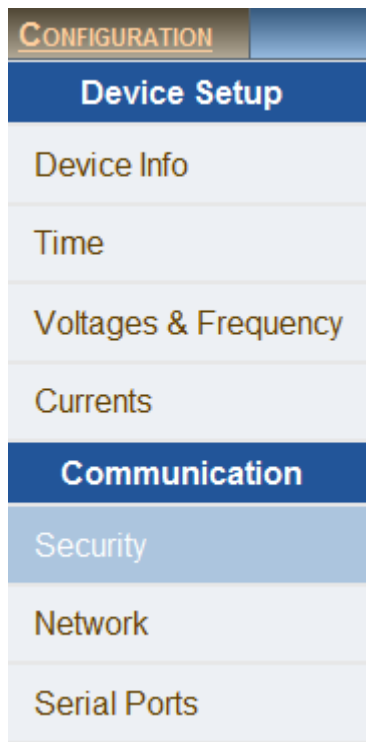

CONFIGURATION
Device Setup
Device Info
Time
Voltages & Frequency
Currents
Communication
Security
Network
Serial Ports

Security

In this window you can set either Entry Passwords to the Web Interface and/or Provide Access to the FTP Server for your G4K unit.

- [Access](#) the G4K Device via Elspec's Web Interface → log on as the Administrator (Manufacturer's Default Password is: 12345) → select the Configuration Tab
- Under Communication select the Security Tab:

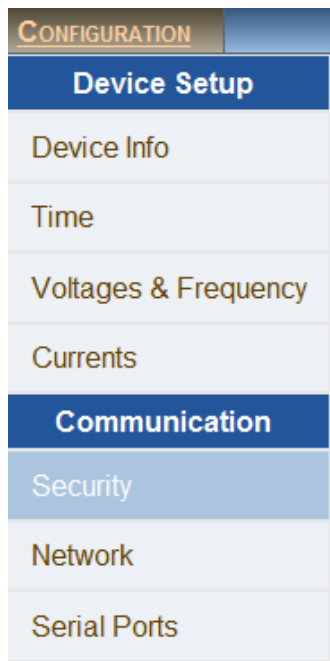

PASSWORD SETUP

This section enables the Administrator to change or reset the passwords of Viewer & Administrator levels at one option at a time:

- Select either the Viewer or Admin option:

Password Setup

[Viewer] [Admin]

Password

Confirm

Set Password

Levels:

- **Viewer:** Users are able to view all the functions within Elspec's Web Interface, but are unable to configure the G4K Device (Manufacture's Default Password is 123)
- **Admin:** Usually the Administrator of the G4K Device, is able to view & configure the unit (Manufacture's Default Password is 12345)
- Enter & Confirm the Password → select **Set Password**
- To Reset the passwords to the Manufacture's Default passwords select **Reset Passwords**.

FTP ACCESS

The G4K BLACKBOX includes a FTP server which is accessed via the PQSCADA / Elspec's Search Utility in order to retrieve the PQZIP files recorded by the unit. The PQZIP files may be manually retrieved by initiating an FTP session with the BLACKBOX device. The FTP Access section below controls the FTP Login and FTP Password for security measures.

- Enter the User Login, Password & Confirm the Password (Manufacture's Default Login is ftpuser & Password is ftppassword)

FTP Access	
FTP Login	<input type="text" value="ftpuser"/>
Password	<input type="text"/>
Confirm	<input type="text"/>
Save FTP Configuration	

- Select **Save FTP Configuration**
- To Reset the passwords to the Manufacture's Default passwords select **Reset Passwords**.

NOTE NOTE NOTE

- Changes made in the FTP Access section needs to be duplicated in the PQSCADA Configuration. (In the F1 Help Wizard of the PQSCADA, follow the Components → Nodes → Configuration → Device procedure)

SEE ALSO

- [About G4K's Communication Configuration](#)
- [Network](#)
- [Serial Ports](#)

About Network Setup

The Network setup is a crucial part of your G4K BLACKBOX's unit configuration. This setup procedure establishes the IP Address of your G4K Unit in the network. The procedure includes:

- [Assign an IP Address for LAN 1 Port](#)
- [Connect G4100 RTU via LAN 2 Port \(if applicable\)](#)
- [Make allowances for Remote Access by configuring the Port Setup](#)
- [Send Data & Notifications from your G4K unit by providing Outer Access](#)
- [Set up ports for Data Retrieval from the G4K Device via Modbus Protocol](#)
- [Set up port for Data Retrieval from the G4K Device over the Ethernet](#)
- [View the Status Summaries of your G4K Device's Network Configurations](#)

OPEN THE NETWORK WINDOW

- [Access G4K Device](#) Configuration via Elspec's Web Interface → log on as the Administrator (Manufacturer's Default Password is: 12345) → select the Configuration Tab
- Under Communication select the Network Tab:

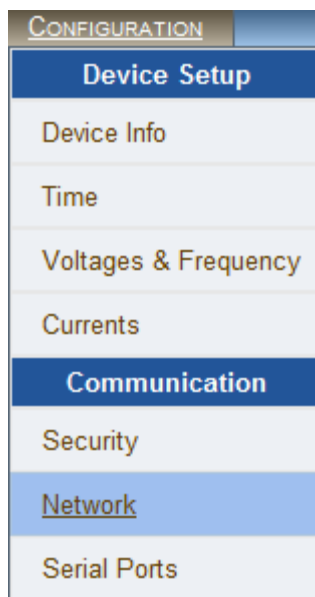

- The Network Window will now open:

RW
■ CONFIGURATION » NETWORK
No DSP Sync

Apply Changes Refresh Data

LAN1

Auto DHCP Enable

IP Address

Subnet Mask

Port Setup

HTTP Port

FTP Daemon

FTP Data

SMTP Port

LAN2/LCD

Auto DHCP Disable

IP Address

Subnet Mask

Outer Access

Gateway

SMTP Server

Network Interface

Interface	Link	Speed	Duplex	Mode
LAN1 [Link]	On	100 Mbits	Full	Auto negotiate
LAN2 [LCD]	Off	10 Mbits	Full	10Mbit FD

Connections

HTTP Active	OPC Active	LCD Active	FTP Active	FTP Max
1	0	0	0	5

Modbus TCP

Slave Address	<input type="text" value="159"/>	Modbus Port	<input type="text" value="502"/>
---------------	----------------------------------	-------------	----------------------------------

DNP3 Configuration

DNP3 Port	Validate IP	Validate Source	Source Address	Destination Address
<input type="text" value="20000"/>	Enable	Disable	<input type="text" value="4"/>	<input type="text" value="3"/>

NOTE NOTE NOTE

- If you are not logged on as the Administrator, you will not be able to change any of these settings & you will receive the following error message in your attempt to do so:

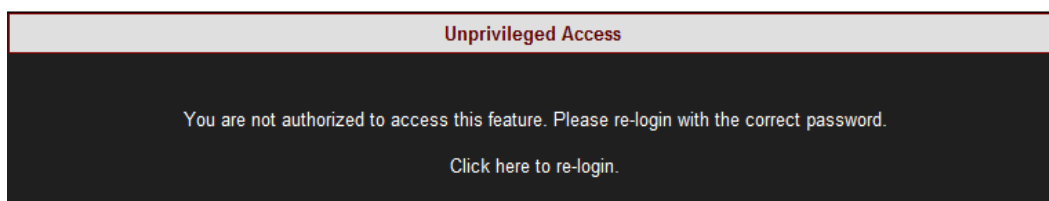

SEE ALSO

- [About G4K's Communication Configuration](#)
- [Security](#)
- [Serial Ports](#)

LAN 1

Each G4K BLACKBOX unit needs to have a fixed IP Address. In each network the available IP numbers differs. The IP Address may be assigned either automatically via the LAN DHCP Server, or manually assigned by the user. Regardless as to what option you choose, prior to assigning the IP address to the unit you will need to consult your IT manager for the network as how to proceed.

HOW TO CONFIGURE LAN 1

- As per the previous step [Access](#) the Network Window & in the LAN 1 Section you will have two options:

LAN1	
Auto DHCP	Enable ▾
IP Address	100.100.100.100
Subnet Mask	255.255.255.0

- Auto DHCP Disable (User Assigned IP Address obtained from the IT Manager) all parameters will be fixed & User-Assigned:
 - Select Auto DHCP Disable
 - Enter the IP Address
 - An optional Subnet Mask (for this port & instrument) is entered as per your IT Manager's instructions
- Auto DHCP Enabled allows the LAN DHCP server to assign an IP Address to the unit
 - Select Auto DHCP Enable
 - Your G4K's unit's IP Address & Subnet Mask will now be automatically assigned
- To apply your changes select [Apply Changes](#) ➔ [Refresh Data](#) to review them

NOTE NOTE NOTE

- LAN 1 & LAN 2 cannot co-exist in the same logical IP subnet, even if only one of them is actively connected to a network. For example: if LAN1 is configured as 172.17.4.68 with subnet mask of 255.255.0.0, then LAN2 cannot be configured as 172.17.X.X.
- The PQSCADA will not be able to identify any newly assigned IP Addresses for your G4K unit. As such, when the PQSCADA will download the PQZIP files from your G4K unit, it will not automatically associate the new IP with the same database. Therefore, you will need to configure the new IP Address for your G4K BLACKBOX Device in the PQSCADA (In the F1 Help Wizard of the PQSCADA, follow the Components ➔ Nodes ➔ Configuration ➔ Device procedure)

SEE ALSO

- [About Network Setup](#)
- [LAN 2 / LCD Port Setup](#)
- [Port Setup](#)
- [Outer Access](#)
- [Modbus TCP](#)
- [DNP3 Configuration](#)
- [Status Summaries](#)

LAN 2 / LCD Port Setup

The LAN 2 port is used for the G4100 LCD Display connection & the configuration procedure is very quick & easy to follow. There is no need to configure the LAN 2 port if the G4100 LCD Display is absent.

The port may also be used for to connect the device to an additional network other than the [LAN 1 Port](#) connection. As mentioned previously each Portable BLACKBOX unit needs to have a fixed IP Address & that in each network the available IP numbers differs. The IP Address may be assigned either automatically via the LAN DHCP Server, or manually assigned by the user. As per the [LAN 1 Port](#), regardless as to what option you choose, prior to assigning the IP address to the unit you will need to consult your IT manager for the network as how to proceed.

HOW TO CONFIGURE LAN 2

- [Access](#) the Network Window
- If you need to change the default settings, in the LAN 2 Section for Auto DHCP select Disable:

LAN2/LCD	
Auto DHCP	Disable ▾
IP Address	192.168.168.168
Subnet Mask	255.255.255.0

- IP Address: Is the IP address for this port on the instrument. It is recommended that you retain the default address of 169.254.249.247 in order to enable the G4100 LCD remote screen viewer's plug-&-play compatibility
- Sub-Net Mask: Is the Sub-net mask for this port on the instrument. It is recommended that you retain the default address of 255.255.255.0 in order to enable the G4100 LCD remote screen viewer's plug-&-play compatibility
- The Default settings will automatically appear in this section should no changes be required & the Auto DHCP will remain on Enable
- To apply your changes select [Apply Changes](#) ➡ [Refresh Data](#) to review them

NOTE NOTE NOTE

IMPORTANT: The IP Address & Sub-net for LAN 1 differs from LAN 2's IP Address & Sub-net as they are configured for two different networks. Therefore should you choose to Disable the default settings, ensure the IP Address for the G4100 LCD Display is configured on an additional Network.

SEE ALSO

- [About Network Setup](#)
- [LAN 1](#)
- [Port Setup](#)
- [Outer Access](#)
- [Modbus TCP](#)
- [DNP3 Configuration](#)
- [Status Summaries](#)

Port Setup

Within the Port Setup section, you will be able to configure your G4K Unit for remote access. In the Port Setup section you can configure the internet port numbers for standard communication protocols (E -Mails, File Transfer & Web Browsing). The primary reasons for utilizing this procedure is for networks where standard port numbers are forbidden or reserved by Firewalls; or it may be used in instances where you would like to reserve the standard port number for a legacy modem/router that does not support port forwarding. Most external modems/routers on the market today do support port forwarding. E lspec recommends retaining the default port addresses setup, in order to simplify & provide straightforward access for web browsers or FTP clients to your G4K unit via LAN/Internet.

CONFIGURING PORT NUMBERS FOR STANDARD COMMUNICATION PROTOCOLS

- [Access](#) the Network Window
- In the Port Setup Section you have the following settings:

Port Setup	
HTTP Port	<input type="text" value="80"/>
FTP Daemon	<input type="text" value="21"/>
FTP Data	<input type="text" value="20"/>
SMTP Port	<input type="text" value="25"/>

- HTTP Port: Utilized for setting the Web Browser's Port Address
- FTP Daemon: Utilized for setting the Port Address of File Transfer (Control Channel)
- FTP Data: Used for setting the Port Address of File Transfer (Data Channel)
- SMTP Port: Used for setting the Port Address of Mail Transfers. The SMTP server should allow anonymous clients. G4d doesn't support SMTP authentication.
- To apply your changes select [Apply Changes](#) → [Refresh Data](#) to review them

NOTE NOTE NOTE

Changes to the FT PP ports also requires changes to Elspec's PQSCADA's configuration. (In the F1 Help Wizard of the PQSCADA, follow the Components → Nodes → Configuration → Device procedure. The FT PP port is added in the PQSCADA as an addition with your G4K's Device IP in the IP Address field as: 100.100.100.100:20)

SEE ALSO

- [About Network Setup](#)
- [LAN 1](#)
- [LAN 2 / LCD Port Setup](#)
- [Outer Access](#)
- [Modbus TCP](#)
- [DNP3 Configuration](#)
- [Status Summaries](#)

Outer Access

In this section you will be able to configure your G4K BLACKBOX for sending data to an IP Address outside its [LAN 1](#) & setting an IP Address for sending Notification E-Mails.

CONFIGURING THE G4K BLACKBOX FOR OUTER ACCESS

- [Access](#) the Network Window
- In the Outer Access Section you have the following settings:

Outer Access	
Gateway	<input type="text" value="100.100.100.100"/>
SMTP Server	<input type="text" value="0.0.0.0"/>

- Gateway: Is utilized for setting the BLACKBOX'S default Gateway IP addresses in order to send data to an IP addresses outside its [LAN 1](#)
- SMTP Server: Is used for setting an IP Address for an E-Mail Server to be used for sending [E-Mail Notifications](#)
- To apply your changes select [Apply Changes](#) ➔ [Refresh Data](#) to review them

NOTE NOTE NOTE

Configurations need to be duplicated & configured in Elspec's PQSCADA. (In the F1 Help Wizard of the PQSCADA, follow the Components ➔ Server ➔ Configuration ➔ E-Mail procedure).

SEE ALSO

- [About Network Setup](#)
- [LAN 1](#)
- [LAN 2 / LCD Port Setup](#)
- [Port Setup](#)
- [Modbus TCP](#)
- [DNP3 Configuration](#)
- [Status Summaries](#)

Modbus TCP

Modbus TCP allows your G4K unit to communicate in Modbus protocol, as well as, serve as a Modbus slave over the Ethernet. This protocol is used to retrieve data from the device. See How to Read and Write MODBUS Parameters for G4K BLACKBOX Device Series, for a detailed procedure on this integration.

MODBUS CONFIGURATION

- [Access](#) the Network Window
- In the Modbus TCP Section you have the following settings:

Modbus TCP			
Slave Address	<input type="text" value="159"/>	Modbus Port	<input type="text" value="502"/>

- Slave Address: ID Address of a unit on a Modbus network
- Modbus Port: TCP Port on which the Modbus Protocol Operates
- To apply your changes select [Apply Changes](#) ➔ [Refresh Data](#) to review them

SEE ALSO

- [About Network Setup](#)
- [LAN 1](#)
- [LAN 2 / LCD Port Setup](#)
- [Port Setup](#)
- [Outer Access](#)
- [DNP3 Configuration](#)
- [Status Summaries](#)

DNP3 Configuration

An Ethernet (OPC) protocol is an additional protocol that may be used for data retrieval from your G4K Unit via a DNP3 Server. It is within this section that you configure the settings for the DNP3 Server.

CONFIGURING THE G4K'S PORT SETTINGS FOR A DNP3 SERVER

- [Access](#) the Network Window
- In the DNP3 Configuration Section you have the following settings:

DNP3 Configuration				
DNP3 Port	Validate IP	Validate Source	Source Address	Destination Address
<input type="text" value="20000"/>	<input type="button" value="Enable"/>	<input type="button" value="Disable"/>	<input type="text" value="4"/>	<input type="text" value="3"/>

- DNP3 Port: TCP port for the DNP3 protocol
- Validate IP: When this option is Enabled (default), it is possible to verify that the IP address of the UDP broadcast messages (if present) is equal to the current active TCP connection address in order to avoid unwanted inbound access
- Validate Source: When this option is Enabled, it is possible to check if the source address (the address of the client which sent the message to the G4k) of a message (any message) is equal to the destination address that the user inserts
- Source Address: The local DNP Address of your G4K Unit
- Destination Address: In order to “Validate Source”
- To apply your changes select → to review them

SEE ALSO

- [About Network Setup](#)
- [LAN 1](#)
- [LAN 2 / LCD Port Setup](#)
- [Port Setup](#)
- [Outer Access](#)
- [Modbus TCP](#)
- [Status Summaries](#)

Status Summaries

Within the [Network Window](#) you are able to view two sections that summarize your G4K BLACKBOX's network configurations. The summaries include:

NETWORK INTERFACE

Network Interface				
Interface	Link	Speed	Duplex	Mode
LAN1 [Link]	On	100 Mbits	Full	Auto negotiate
LAN2 [LCD]	Off	10 Mbits	Full	10Mbit FD

- LAN 1 Status:
 - Link: On (indicates G4K Unit's IP Address is established in your Network) / Off (G4K Unit's IP Address is not established)
 - Speed: Flow control of data transferrable speed
 - Duplex: Full (using Full Duplex for communication) / Half (using Half Duplex for communication)
 - Mode: Auto negotiate means that your G4K connected with the Network server chooses common transmission parameters (Speed, Duplex Mode & Flow Control)
- LAN 2 G4100 LCD Status:
 - Link: On (indicates your G4100 Unit's IP Address is established in the 2nd Network) / Off (Unit's IP Address is not established / not in use)
 - Speed: Flow control of data transferrable speed
 - Duplex: Full (using Full Duplex for communication) / Half (using Half Duplex for communication)
 - Mode: Transmission parameter is set at 10Mbit at Full Duplex (FD) to the 2nd Network's Server

CONNECTIONS

Connections				
HTTP Active	OPC Active	LCD Active	FTP Active	FTP Max
1	0	0	0	5

- HTTP Active: Connection status of your G4K BLACKBOX Unit & Web Browser as per [Port Configuration](#)
- OPC Active: Connection status between your G4K BLACKBOX & the [DNP3 OPC Server](#)
- LCD Active: Connection status of G4100 as per [LAN 2 Configuration](#) to the 2nd Network
- FTP Active: Connection status of the File Transfer Control Channel as per

- FTP Max: Number of users defined FTP Access
- Review your changes by selecting [Refresh Data](#)

SEE ALSO

- [About Network Setup](#)
- [LAN 1](#)
- [LAN 2 / LCD Port Setup](#)
- [Port Setup](#)
- [Outer Access](#)
- [Modbus TCP](#)
- [DNP3 Configuration](#)

Serial Ports

In this section you will be able to configure the serial lines of your G4K BLACKBOX for data link connectivity, including:

- [Setting up the configurations of the RS485/RS422 interface parameters itself](#)
- [Configuring the PPP \(Point-to-Point Protocol\) parameters for serial communication](#)
- [Viewing the status of the PPP](#)
- [Setting up a standard AT commands modem](#) (See also [G4K GPRS Remote Modem Connectivity](#))

OPEN THE SERIAL PORTS WINDOW

- [Access](#) G4K Device Configuration via Elspec's Web Interface → log on as the Administrator (Manufacturer's Default Password is: 12345) → select the Configuration Tab
- Under Communication select the Serial Ports Tab:

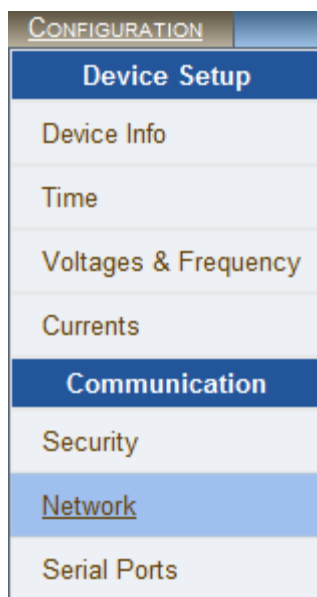

- The Serial Ports Window will now open:

RO
■ CONFIGURATION » SERIAL PORTS
No DSP Sync

Apply Changes Refresh Data Connect Disconnect Reset modem

RS-485 / RS-422

Bitrate	Data Bits	Parity	Stop Bits
19200 ▾	8 bit	None	
Serial Mode		ModBus Slave Address	
TTY ▾		159 ▾	

PPP Status

[Message Log]

PPP IP	PPP Subnet	Signal Quality
N/A	N/A	-----

Message Log

Empty

PPP Configuration

PAP Status	CHAP Status	Username	Password	PoE Auto reset
Enable ▾	Enable ▾	<input type="text"/>	<input type="text"/>	Disable ▾

Modem Configuration

Init String <input type="text"/>	Reset String <input type="text"/>
Default Init <input type="text"/>	Phone Number <input type="text"/>

NOTE NOTE NOTE

- If you are not logged on as the Administrator, you will not be able to change any of these settings & you will receive the following error message in your attempt to do so:

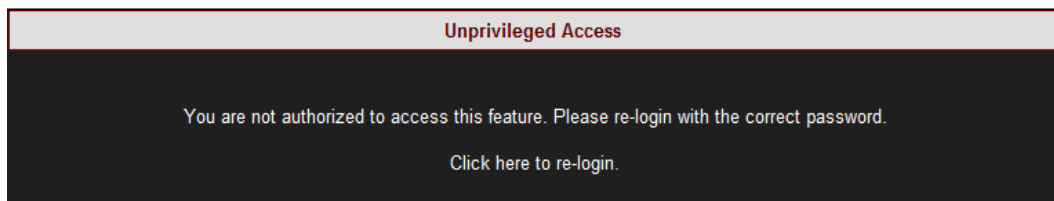

SEE ALSO

- [About G4K's Communication Configuration](#)
- [Security](#)
- [Network](#)

RS-485 / RS-422

The setup configures the parameters of RS-485/RS-422 serial interface.

HOW TO CONFIGURE RS-485 / RS-422 SERIAL INTERFACE

- As per the previous step [Access](#) the Serial Ports Window & in the RS-485/RS-422 Section complete the applicable Parameters:

RS-485 / RS-422			
Bitrate	Data Bits	Parity	Stop Bits
19200 ▼	8 bit	None	
Serial Mode		ModBus Slave Address	
TTY ▼		159 ↕	

- Bitrate: With the ▼adjust the transfer rate for data
 - Data Bits: (For information only) Indicates the number of data bits in a byte
 - Parity: (For information only) Parity code indicating error detection (Movement of digital data from one location to another)
 - Stop Bits: (For information only) Number of stop bits used to mark the end of a byte transmission
 - Serial Mode: With the ▼select configuration from available Options:
 - TTY: Debug shell mode for PPP stream
 - Elcom : Elspec communication for connecting to the Equalizer
 - ModBus RTU: ModBus protocol (serving as a slave on a Modbus network)
 - GPS: For GPS attachment to this serial port
 - PPP: Connection for PPP communication through this serial port
 - ModBus Slave Address: Unique ID of the BLACKBOX on a Modbus network
- To apply your changes select **Apply Changes** → **Refresh Data** to review them
 - In order to establish connection as per the setup configurations select **Connect**
 - In order to discontinue the connection select **Disconnect**

SEE ALSO

- [About Serial Ports](#)
- [PPP Configuration](#)
- [PPP Status](#)
- [Modem Configuration](#)

PPP Configuration

In this section you will be able to configure PPP (Point-to-Point Protocol) parameters for serial communication.

HOW TO CONFIGURE PPP PARAMETERS

- [Access](#) the Serial Ports Window & in the PPP Configuration Section complete the applicable Parameters:

PPP Configuration				
PAP Status	CHAP Status	Username	Password	PoE Auto reset
Enable ▾	Enable ▾	<input type="text"/>	<input type="text"/>	Disable ▾

- PAP Status: With the ▾Enable/Disable the PAP (Password Authentication Protocol) feature
 - CHAP Status: Enable/Disable CHAP (Challenge Handshake Authentication Protocol) feature
 - Username: This is the Username that you receive from your ISP (Internet Service Provider)
 - Password: This is the Password that you receive from your ISP
- To apply your changes select **Apply Changes** ➔ **Refresh Data** to review them
 - In order to establish connection as per the setup configurations select **Connect**
 - In order to discontinue the connection select **Disconnect**

SEE ALSO

- [About Serial Ports](#)
- [RS-485 / RS-422](#)
- [PPP Status](#)
- [Modem Configuration](#)

PPP Status

This indicates the status of the PPP with a Log.

HOW TO VIEW PPP STATUS

- [Access](#) the Serial Ports Window & in the PPP Status section Select/Deselect the Message Log with . This will Enable/Disable the logging of this protocol's activity in the log:

PPP Status <input checked="" type="checkbox"/> [Message Log]		
PPP IP	PPP Subnet	Signal Quality
N/A	N/A	-----
Message Log		
Empty		

- To apply your changes select [Apply Changes](#) ➔ [Refresh Data](#) to review them

SEE ALSO

- [About Serial Ports](#)
- [RS-485 / RS-422](#)
- [PPP Configuration](#)
- [Modem Configuration](#)

Modem Configuration

The following strings require setup when working with a standard AT commands modem.

HOW TO CONFIGURE THE MODEM SETUP

- [Access](#) the Serial Ports Window & in the Modem Configuration Section complete the applicable Parameters:

Modem Configuration			
Init String	<input type="text"/>	Reset String	<input type="text"/>
Default Init	<input type="text"/>	Phone Number	<input type="text"/>

- Init String: AT command string to initialize the modem
 - Reset String: AT command string to reset the modem
 - Default Init: AT command string to set the modem to default configuration
 - Phone Number: Dial up number (without any gaps/hyphenation marks)
- To apply your changes select **Apply Changes** → **Refresh Data** to review them
 - In order to connect the modem as per the setup configurations select **Connect**
 - In order to disconnect the modem select **Disconnect**

SEE ALSO

- [About Serial Ports](#)
- [RS-485 / RS-422](#)
- [PPP Configuration](#)
- [PPP Status](#)

About Power Quality Compliance

The G4K BLACKBOX device series provides PQ Parameters according to EN50160 & IEC61000-4-30, including other National Standards. In this window you will be able to:

- [Select the specific compliance standard to be evaluated by the unit's internal compliance engine](#)
- [Customize parameters to comply with any other unique standards or requirements](#)

ACCESS THE G4K'S POWER QUALITY COMPLIANCE WINDOW

- [Access](#) the G4K Device via Elspec's Web Interface → log on as the Administrator (Manufacturer's Default Password is: 12345) → select the Configuration Tab
- All the PQ compliance configurations (including the user-defined pages) are located under the PQ Compliance Tab:

CONFIGURATION
Device Setup
Device Info
Time
Voltages & Frequency
Currents
Communication
Security
Network
Serial Ports
PQ Compliance
Power Compliance
User Defined Page 1
User Defined page 2
User Defined page 3

Power Quality Compliance Configuration

The G4K BLACKBOX contains a power quality compliance engine that enables real-time evaluation of power quality according to a number of standards, such as:

- EN50160
- EN50160 Asynchronous Torque
- NVE-PQ (Norway)
- NVE (Islands)
- CREG (Colombia)
- AER (Queensland - Australia)

On this page you will be able to select the specific compliance standard to be evaluated by your G4K unit's internal compliance engine.

- [Access](#) the G4K Device via Elspec's Web Interface → log on as the Administrator (Manufacturer's Default Password is : 12345) → select Configuration → PQ Compliance → Power Compliance. The Power Compliance window will now open:

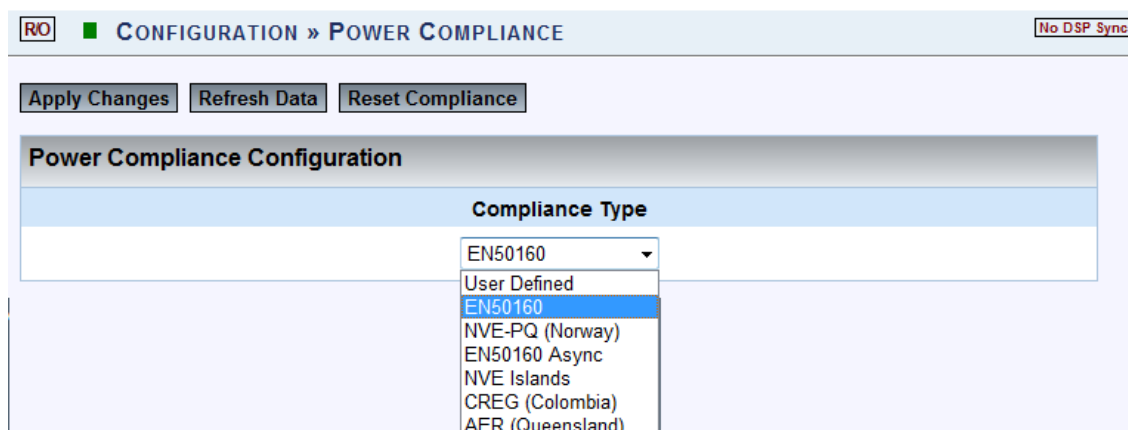

- From the drop down selection ▼select the Applicable Compliance Standard
- Select [Apply Changes](#) & the following Message Box will appear in order to Restart the Compliance Evaluations by the G4K:

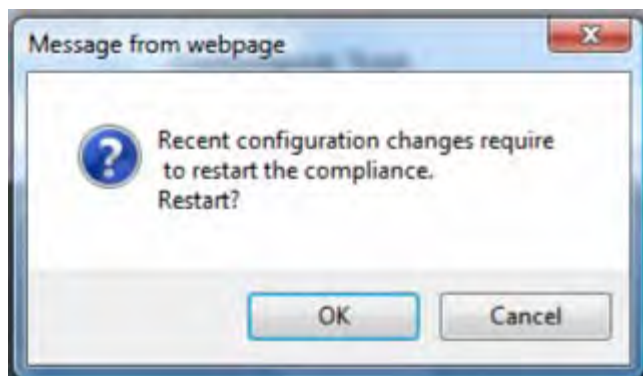

- Select  & you will receive the following Success Message:





- Select  to review your changes

NOTE NOTE NOTE

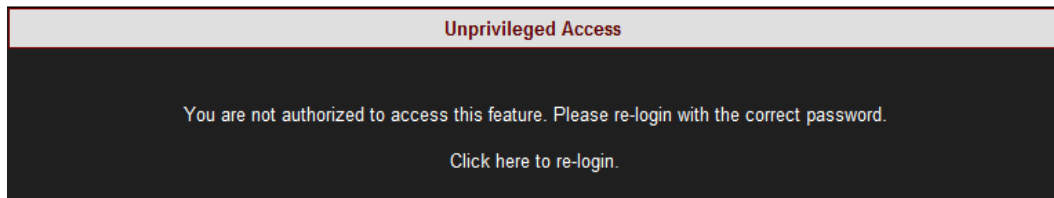
- If you are not logged on as the Administrator, you will not be able to change any of these settings & you will receive the following error message in your attempt to do so:

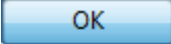

- Once you have signed on as the Administrator ensure that you select    to actually affect your changes.

SEE ALSO

- [About PQ Compliance](#)
- [User Defined Pages](#)
- [User Defined Page 1](#)
- [User Defined Page 2](#)
- [User Defined Page 3](#)

User Defined Pages

In addition to real-time evaluations for a number of [Power Quality Compliance](#) standards, the G4K's built-in PQ engine supports a user-compliance mode in which all compliance parameters can be self-edited & modified. This self-editing & modification allows the user to set parameters that will meet unique conditions, rules, measurement intervals at different observation periods. The windows consist of:

- [User Defined Page 1](#) - Which encompasses: Voltage Frequencies, Voltage Dips Supply, Long Interruptions & Temporary Overvoltage (Swells)
- [User Defined Page 2](#) - Which encompasses: Voltage Variations, Rapid Voltage Changes, Unbalanced Voltage & Voltage Flickering
- [User Defined Page 3](#) - Which encompasses: Voltage Harmonics (Including individual Harmonics)

OPEN & ACTIVATE THE USER DEFINED PAGES

- [Access](#) the G4K Device via Elspec's Web Interface → log on as the Administrator (Manufacturer's Default Password is: 12345) → select Configuration Tab → PQ Compliance Tab
- In the Power Compliance window select User Defined:

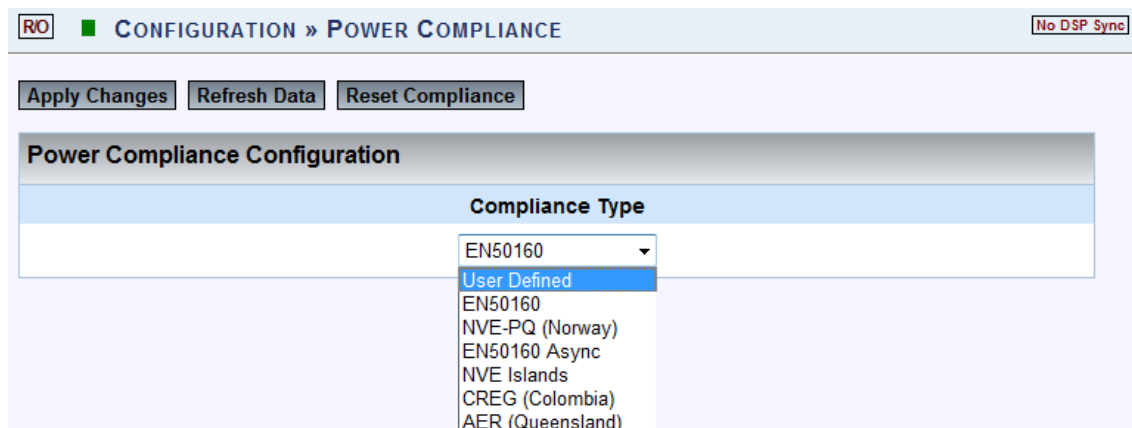

- Select [Apply Changes](#) & the following Message Box will appear in order to Restart the Compliance Evaluations by the G4K:

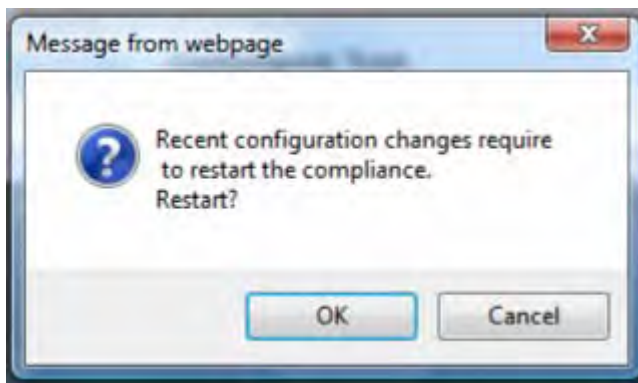

- Select **OK** & you will receive the following Success Message:

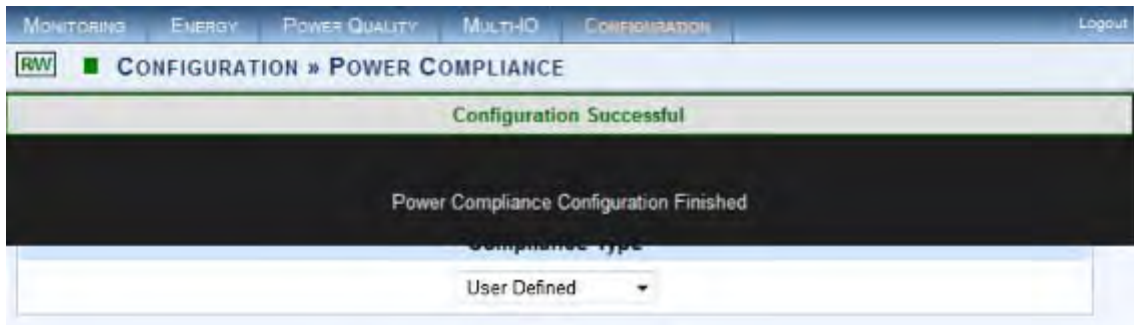

- Select **Refresh Data** to review your changes.

NOTE NOTE NOTE

- If you are not logged on as the Administrator, you will not be able to change any of these settings & you will receive the following error message in your attempt to do so:

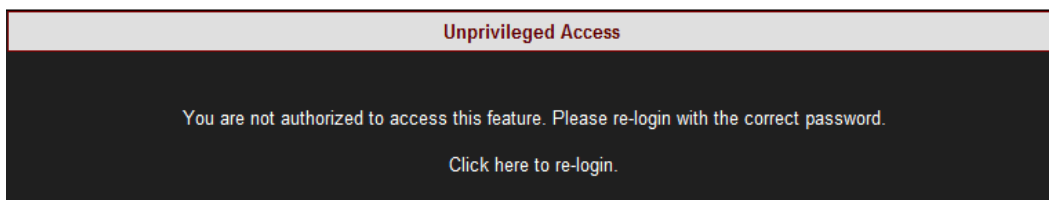

- Once you have signed on at the Administrator ensure that you select **Apply Changes** → **OK** to actually affect your changes.

SEE ALSO

- [About PQ Compliance](#)
- [Power Quality Compliance Configuration](#)
- [User Defined Page 1](#)
- [User Defined Page 2](#)
- [User Defined Page 3](#)

User Defined Page 1

In this window you will be able to edit & modify a number of compliance parameters thereby enabling your G4K BLACKBOX's built-in engine to perform real-time evaluations that will meet unique [Power Quality Compliance](#) standards.

- After you have set the [PQ Compliance to Evaluate User Defined Parameters](#), open PQ Compliance → User Defined Page 1:

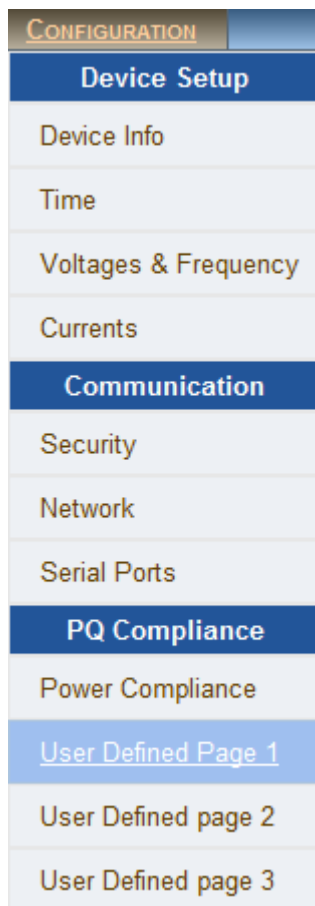

- Collapse / Expand with in order to edit & modify compliance parameters for each of the following sections:

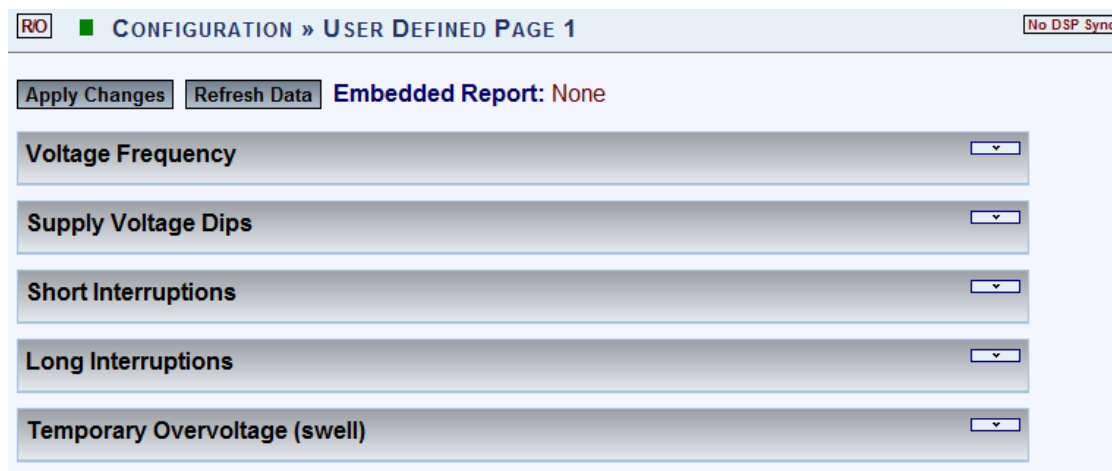

VOLTAGE FREQUENCIES

Voltage Frequency

Enable check only inside limits of $V_{nom} +$ and $V_{nom} +$ (0 - no limit)

Threshold 1: Detect event if $F > F_{nom} +$ or $F < F_{nom} -$

Compliance Condition 1: Frequency must be valid for at least of time.

Threshold 2: Detect event if $F > F_{nom} +$ or $F < F_{nom} -$
(critical)

Compliance Condition 2: Frequency must be valid for at least of time.

Detection Interval: Observation Window:

Ignore Flagged intervals (due to dips/swells) and do not generate events:

Ignore Flagged intervals (due to volt interruption) and do not generate events:

- Frequency compliance is based on statistics: N , N_1 & N_2 . Frequency measurement interval is 10 sec in an entire observation window of 1 week. N - amount of intervals. N_1 - intervals frequency exceeded $[+1.00\%, -1.00\%]$ from nominal freq. N_2 - intervals frequency exceeded $[+4.00\%, -6.00\%]$ from nominal freq. N_1 & N_2 increment only if valid voltage inside nominal boundary of $[+15.0\%, -15.0\%]$. Compliance if both $N/N_1 \geq 95.0\%$ of time and $N/N_2 \geq 100.0\%$ of time. Intervals with voltage interruption are discarded. Intervals with DIPS or Over voltage are discarded.

SUPPLY VOLTAGE DIPS

Supply Voltage Dips

Dip Depth Threshold: Detect event if $V < V_{nom} -$

Manual deactivation Hysteresis+

Max Depth Threshold: Stop detection if $V < V_{Nom} -$

Max allowed dip duration:

Compliance Condition: Allowed number of dips per observation window:

Record events separately for each of 3 phases:

Voltage events reference type:

Detection Interval: Observation Window:

- DIP is a voltage drop of more than 10.0% from Nominal (but no more than 100.0%, and deactivate on 8.0%) DIP min time is 10 ms and max time of 1 min. DIP events are counted per all phases combined within observation window of 1 week. Total events (N) allowed is: 20.

SHORT INTERRUPTIONS

Short Interruptions

Detection threshold: $V < V_{nom} -$ %

One phase drop is enough to trigger event (if not checked, all phases must go down to trigger event)

Manual deactivation Hysteresis+ %

Max allowed short interruption duration:

Compliance Condition: Max allowed number of short interruptions per observation window:

Detection Interval: Observation Window:

- Short interruption is a voltage drop of less than 97.0% from nominal (event deactivate on 77.6%). Min duration 10 ms, Max duration 3 min. events are counted in the entire observation window of 1 week. Total events (N) allowed is: 2.

LONG INTERRUPTIONS

Long Interruptions

Detect threshold is same as for short interruptions.

Detect when duration is larger than the maximum allowed for short interruptions

Allowed number of long interruptions per observation window:

Detection Interval: Observation Window:

- Long interruptions are the same as short ones but with a longer duration (longer than short interruption maximum time). Long interruptions events are counted within observation window of 1 week. Total events (N) allowed is: 1.

TEMPORARY OVERVOLTAGE (SWELLS)

Temporary Overvoltage (swell)

Detection threshold: $V > V_{Nom} +$ %

Manual deactivation Hysteresis- %

Detect up to level of: $V_{Nom} +$ %

Compliance Condition: Max allowed number of overvoltages per observation window:

Record events separately for each of 3 phases:

Voltage events reference type:

Detection Interval: Observation Window:

- Over-voltage events are characterized with RMS voltage higher than 10.0% above Nominal (event deactivate on 8.0%). Min over-voltage event duration is 10 ms, events are counted per all phases combined within observation window of 1 week. No specific events count limitation defined.
- After you have made your selection, select **Apply Changes** & the following Message Box will appear in order to Restart the Compliance Evaluations by the G4K:

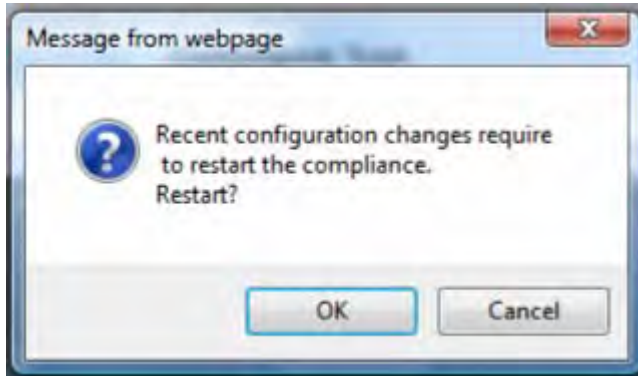

- Select **OK** & you will receive the following Success Message:

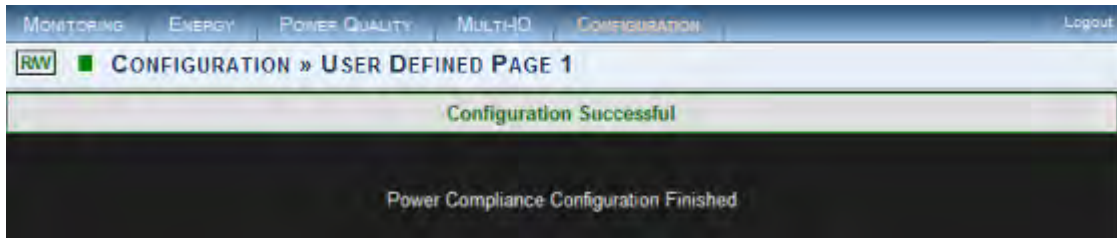

- Select **Refresh Data** to review your changes.

NOTE NOTE NOTE

- If you are not logged on as the Administrator, you will not be able to change any of these settings & you will receive the following error message in your attempt to do so:

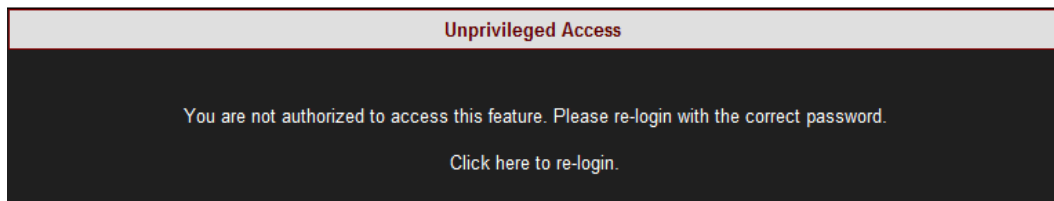

- Once you have signed on as the Administrator ensure that you select **Apply Changes** → **OK** to actually affect your changes.

SEE ALSO



- [About PQ Compliance](#)
- [Power Quality Compliance Configuration](#)
- [User Defined Pages](#)
- [User Defined Page 2](#)
- [User Defined Page 3](#)

User Defined Page 2

In this window you will be able to edit & modify a number of compliance parameters thereby enabling your G4K BLACKBOX's built-in engine to perform real-time evaluations that will meet unique [Power Quality Compliance](#) standards.

After you have set the [PQ Compliance to Evaluate User Defined Parameters](#), open PQ Compliance → User Defined Page 2:



- Collapse / Expand with   in order to edit & modify compliance parameters for each of the following sections:



VOLTAGE VARIATIONS

Voltage Variations	
Threshold 1:	Detect event if $V < V_{nom} + 10\%$ or $V < V_{nom} - 10\%$
Compliance Condition 1:	Voltage must be valid for at least 95% of time.
Threshold 2: <u>(critical)</u>	Detect event if $V < V_{nom} + 15\%$ or $V < V_{nom} - 15\%$
Compliance Condition 2:	Must be valid all time.
Enable entire observation window condition	No
Compliance Condition:	Voltage mean of entire observation window must be within $V_{nom} + 0\%$ and $V_{nom} - 0\%$
Detection Interval:	10 Min.
Observation Window:	1 Week
Ignore Flagged intervals (due to volt interruption) and do not generate events:	Yes
Ignore Flagged intervals (due to dips/swells) and do not generate events:	Yes

- Variations are evaluated by collecting statistics: N, N1 & N2. Statistics are collected as average voltage within intervals of 10 min in observation window of 1 week. N - amount of intervals. N1 - intervals voltage exceeded [+10.0%, -10.0%] boundary of nominal. N2 - intervals voltage exceeded [+15.0%, -15.0%] boundary of nominal. Compliance if $N/N1 \geq 95.0\%$ during the entire observation window. Intervals with voltage interruption are discarded. Intervals with DIPS or OVER Voltage are discarded.

RAPID VOLTAGE CHANGES

Rapid Voltage Changes	
Enable check only inside limits of $V < V_{nom} \pm 10\%$ (0 - no limit)	
Compliance Condition 1:	Event of $dV > 5\%$ allowed up to 65536 occurrences.
Compliance Condition 2:	Event of $dV > 0\%$ allowed up to 0 occurrences.
Compliance Condition 3:	Event of $dV > 0\%$ allowed up to 0 occurrences.
Compliance Condition 4:	Event of $dV > 0\%$ allowed up to 0 occurrences.
Detection Interval:	3 Sec.
Observation Window:	1 Week

- Rapid voltage change is based on a 3 Sec window in which RMS voltage min and max values are obtained (min, max values should be within $\pm 10.0\%$ from nominal). The rapid change is the percent of delta between min and max divided by average RMS of 9 Sec. The Rapid percent results are evaluated during observation window of 1 week. Rapid changes are limited to specific count (N): Rapids of more 5.00% allowed: $N \leq 65536$ occurrences.

VOLTAGE UNBALANCE

Voltage Unbalance	
Enable check only inside limits of $V < V_{nom} + 15\%$ and $V_{nom} - 15\%$ (0 - no limit)	
Threshold 1:	Detect event if $V_{unbal} > 2\%$ (0 - no detection)
Compliance Condition:	V_{unbal} must be kept under the detection limit at least 95% of time.
Detection Interval:	10 Min. ▾
Observation Window:	1 Week ▾
Additional Interval2:	1 Sec. ▾
Threshold 2:	$V_{unbal} > 0\%$ (0 - no detection)
Additional Interval3:	1 Sec. ▾
Threshold 3:	$V_{unbal} > 0\%$ (0 - no detection)
Additional Interval4:	1 Sec. ▾
Threshold 4:	$V_{unbal} > 0\%$ (0 - no detection)
Ignore Flagged intervals (due to volt interruption) and do not generate events: Yes ▾	
Ignore Flagged intervals (due to dips/swells) and do not generate events: Yes ▾	

- Voltage unbalance is evaluated at intervals of 10 min within observation window of 1 week. Evaluation is only at intervals in which voltage is inside nominal boundary of [+15.0%, -15.0%]. Unbalance limit N1 is set to 2.00% and must be kept 95.0% of observation time. Intervals with voltage interruption are discarded. Intervals with DIPS or Over voltage are discarded.

VOLTAGE FLICKER

Voltage Flicker	
PST (10 min) Threshold:	Detect event if $PST > 0$ (0 - no detection)
PST (10 min) Condition:	PST limits are kept for at least 0% of time.
PLT (2 hour) Threshold:	Detect event if $PLT > 1$ (0 - no detection)
PLT (2 hour) Condition:	PLT limits are kept for at least 95% of time.
Detection Interval:	10 Min. ▾
Observation Window:	1 Week ▾
Ignore Flagged intervals (due to volt interruption) and do not generate events: Yes ▾	
Ignore Flagged intervals (due to dips/swells) and do not generate events: Yes ▾	

- Flicker severity is evaluated within observation window of 1 week. During interruption Flicker interval is discarded. During DIPS or Over voltage Flicker Interval is discarded. Plt (2 hours) must be equal or under 1.0 during 95.0% of observation time.

- After you have made your selection, select **Apply Changes** & the following Message Box will appear in order to Restart the Compliance Evaluations by the G4K:

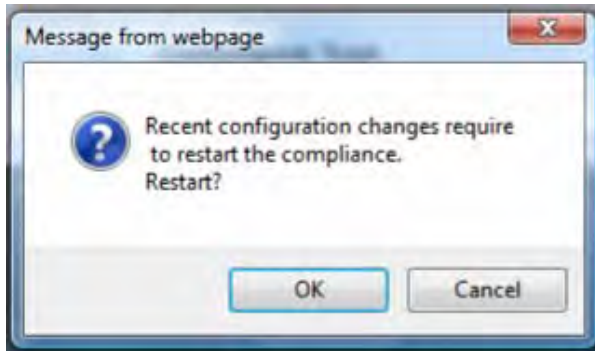

- Select **OK** & you will receive the following Success Message:



- Select **Refresh Data** to review your changes.

NOTE NOTE NOTE

- If you are not logged on as the Administrator, you will not be able to change any of these settings & you will receive the following error message in your attempt to do so:

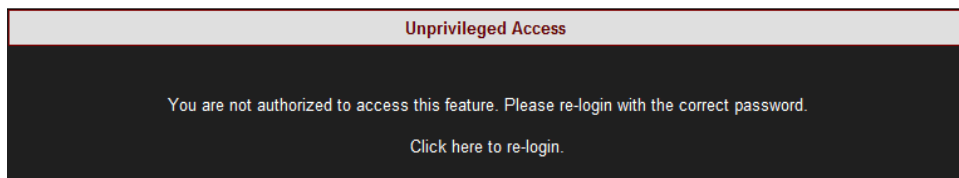

- Once you have signed on as the Administrator ensure that you select **Apply Changes** → **OK** to actually affect your changes.

SEE ALSO

- [About PQ Compliance](#)
- [Power Quality Compliance Configuration](#)
- [User Defined Pages](#)
- [User Defined Page 1](#)
- [User Defined Page 3](#)

User Defined Page 3

In this window you will be able to edit & modify a number of compliance parameters thereby enabling your G4K BLACKBOX's built-in engine to perform real-time evaluations that will meet unique [Power Quality Compliance](#) standards.

After you have set the [PQ Compliance to Evaluate User Defined Parameters](#), open PQ Compliance → User Defined Page 3:

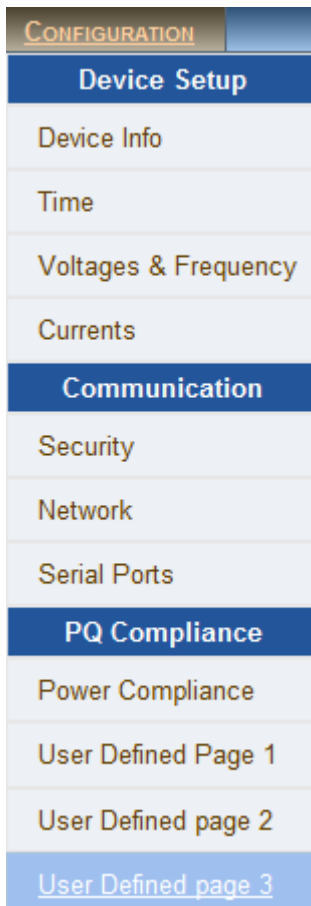

- Collapse / Expand with in order to edit & modify compliance parameters for each of the following sections:

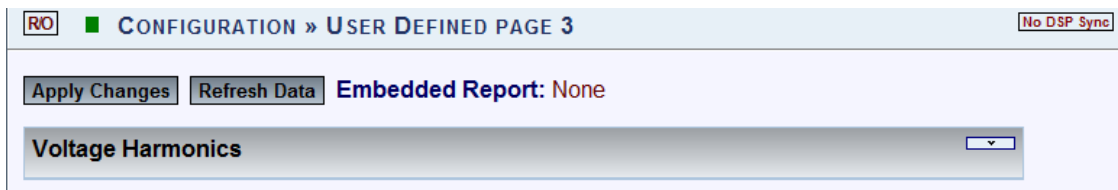

VOLTAGE HARMONICS

Voltage Harmonics

Enable check only inside limits of $V < V_{nom} + 15\%$ and $V_{nom} - 15\%$ (0 - no limit)

Threshold: THD > % (0 - no detection)
Individual harmonic limits are specified in the table below

Compliance Condition 1: THD and harmonics are below specified limits
for at least % of time.

Compliance Condition 2: THD over entire observation
window must be less than % (0 - no detection)

Detection Interval: Observation Window:

Ignore Flagged intervals (due to volt interruption) and do not generate events:

Ignore Flagged intervals (due to dips/swells) and do not generate events:

- Harmonics evaluated at intervals of 10 min within observation window of 1 week. Evaluation at intervals in which voltage is inside nominal boundary of [+15.0%, -15.0%]. Discarding Intervals with VOLT-INT. Discarding Intervals with DIPS or OVER-VOLT. Individual Harmonic limited according to the following table: $H_2 \leq 2.0\%$, $H_3 \leq 5.0\%$, $H_4 \leq 1.0\%$, $H_5 \leq 6.0\%$, $H_6 \leq 0.5\%$, $H_7 \leq 5.0\%$, $H_8 \leq 0.5\%$, $H_9 \leq 1.5\%$, $H_{10} \leq 0.5\%$, $H_{11} \leq 3.5\%$, $H_{12} \leq 0.5\%$, $H_{13} \leq 3.0\%$, ... THD limit is set 8.0% (N2). THD and Harms limits shall be kept at least 95.0% of time.

INDIVIDUAL HARMONIC LIMITS

Individual Harmonic Limits:				
	$H_2 < \text{2\%}$	$H_3 < \text{5\%}$	$H_4 < \text{1\%}$	$H_5 < \text{6\%}$
$H_6 < \text{0.5\%}$	$H_7 < \text{5\%}$	$H_8 < \text{0.5\%}$	$H_9 < \text{1.5\%}$	$H_{10} < \text{0.5\%}$
$H_{11} < \text{3.5\%}$	$H_{12} < \text{0.5\%}$	$H_{13} < \text{3\%}$	$H_{14} < \text{0.5\%}$	$H_{15} < \text{0.5\%}$
$H_{16} < \text{0.5\%}$	$H_{17} < \text{2\%}$	$H_{18} < \text{0.5\%}$	$H_{19} < \text{1.5\%}$	$H_{20} < \text{0.5\%}$
$H_{21} < \text{0.5\%}$	$H_{22} < \text{0.5\%}$	$H_{23} < \text{1.5\%}$	$H_{24} < \text{0.5\%}$	$H_{25} < \text{1.5\%}$
$H_{26} < \text{0.5\%}$	$H_{27} < \text{0.5\%}$	$H_{28} < \text{0.5\%}$	$H_{29} < \text{1\%}$	$H_{30} < \text{0.5\%}$
$H_{31} < \text{1\%}$	$H_{32} < \text{0.5\%}$	$H_{33} < \text{0.5\%}$	$H_{34} < \text{0.5\%}$	$H_{35} < \text{1\%}$
$H_{36} < \text{0.5\%}$	$H_{37} < \text{1\%}$	$H_{38} < \text{0.5\%}$	$H_{39} < \text{0.5\%}$	$H_{40} < \text{0.5\%}$

- After you have made your selection, select **Apply Changes** & the following Message Box will appear in order to Restart the Compliance Evaluations by the G4K:

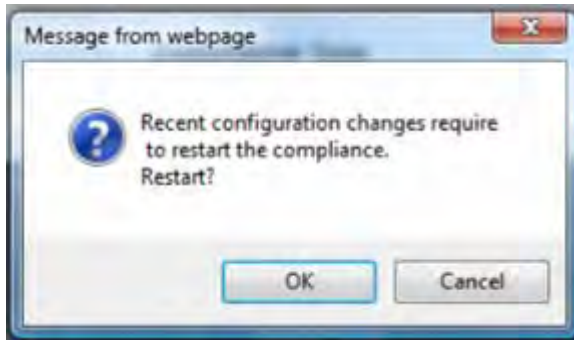

- Select **OK** & you will receive the following Success Message:

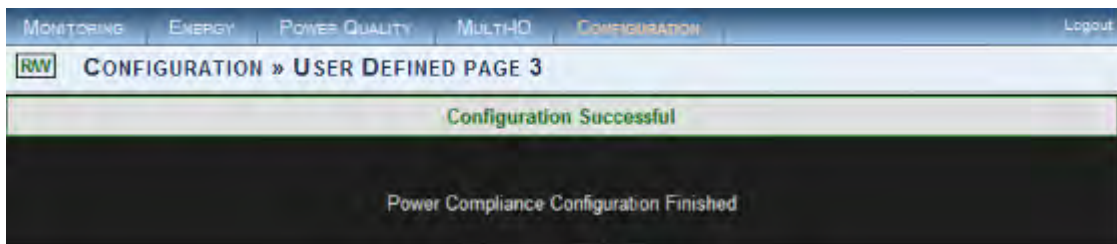

- Select **Refresh Data** to review your changes.

NOTE NOTE NOTE

- If you are not logged on as the Administrator, you will not be able to change any of these settings & you will receive the following error message in your attempt to do so:

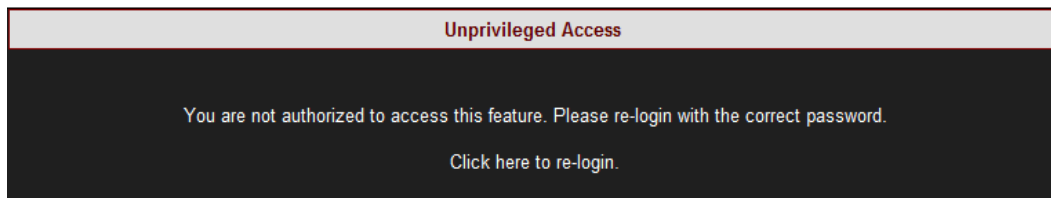

- Once you have signed on as the Administrator ensure that you select **Apply Changes** → **OK** to actually affect your changes.

SEE ALSO

- [About PQ Compliance](#)
- [Power Quality Compliance Configuration](#)
- [User Defined Pages](#)
- [User Defined Page 1](#)
- [User Defined Page 2](#)

Advanced Settings

Within the Advanced Tab you may configure the G4K BLACKBOX device series' unique capabilities. These capabilities include:

- [View & Copy the System Log](#)
- [Create Custom Events](#)
- [Configure & Send E-Mail Alerts](#)
- [Produce Energy & Parameter Logs for Reporting](#)
- [Configure the Energy Meter](#)
- [Customize Display in Display Setup](#)
- [Upgrade your G4K's Software](#)

OPEN THE ADVANCED TAB

- Access your G4K Device via Elspec's Web Interface → log on as the Administrator (Manufacturer's Default Password is: 12345) → select the Configuration Tab
- All the advanced settings are located under the Advanced Tab:

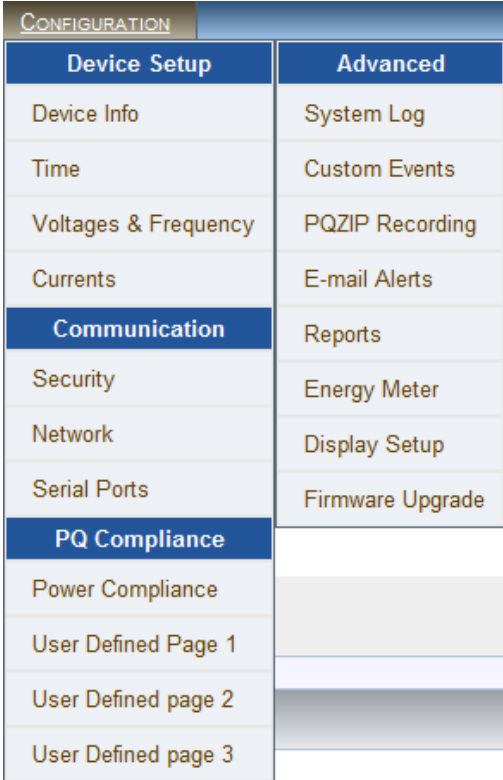

CONFIGURATION	
Device Setup	Advanced
Device Info	System Log
Time	Custom Events
Voltages & Frequency	PZQP Recording
Currents	E-mail Alerts
Communication	Reports
Security	Energy Meter
Network	Display Setup
Serial Ports	Firmware Upgrade
PQ Compliance	
Power Compliance	
User Defined Page 1	
User Defined page 2	
User Defined page 3	

NOTE NOTE NOTE

- If you are not logged on as the Administrator, you will not be able to change any of these settings & you will receive the following error message in your attempt to do so:

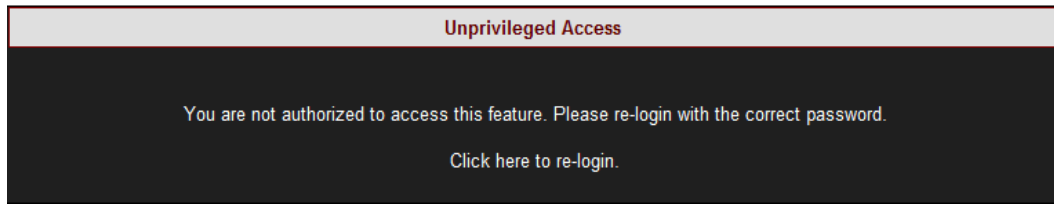

System Log

The System Log displays existing user events. All events are created in the [Custom Events](#) & the [Energy & Parameter Logs are created in Reports](#). Within the Log you can decide what data you would like to display & produce a report.

CONFIGURE THE SYSTEM LOG

- Access your G4K Device → log on as the Administrator (Manufacturer's Default Password is: 12345) → under Configuration → [Advanced](#) open the System Log Tab:

CONFIGURATION	
Device Setup	Advanced
Device Info	System Log
Time	Custom Events
Voltages & Frequency	PQZIP Recording
Currents	E-mail Alerts
Communication	Reports
Security	Energy Meter
Network	Display Setup
Serial Ports	Firmware Upgrade
PQ Compliance	
Power Compliance	
User Defined Page 1	
User Defined page 2	
User Defined page 3	

- The System Log window will now open:

CONFIGURATION » SYSTEM LOG No DSP Sync

Show events of type: [Init] [System] [User] [Measurement]

Start at Page Size Time

#	Event Timestamp	Code	Detailed Event Data
0	23/06/2011 19:02:50	143	Red LED Status 0x02000000
1	23/06/2011 19:02:30	143	Red LED Status 0x02100000
2	23/06/2011 19:02:29	65	PQzip: Insufficient Memory - Drop Data 2043
3	23/06/2011 06:53:05	229	User Defined Event 29: 103.500000 (29.345703[dev%] 0.016663[sec] Severity:129 Phases:WYE 4 wires:;3)
4	23/06/2011 06:53:05	229	User Defined Event 29: 103.500000 (29.345703[dev%] 0.000000[sec] (Event Begin) Severity:0 Phases:WYE 4 wires:;3)
5	23/06/2011 02:29:30	143	Red LED Status 0x02000000
6	23/06/2011 02:29:10	143	Red LED Status 0x02100000
7	23/06/2011 02:29:09	65	PQzip: Insufficient Memory - Drop Data 2043
8	22/06/2011 16:15:45	143	Red LED Status 0x02000000
9	22/06/2011 16:15:24	143	Red LED Status 0x02100000

OPTIONS & FUNCTIONS:

- Show Events of type (Color Coded) - You may choose the type of events to display in the list:
 - Init: Data related to Modem initialization
 - System: All Flagged function & configurations related to your G4K Device system
 - User: All User-Defined events
 - Measurement: All Flagged events related to recording & measurements of your G4K Device
- Start at: Specify the event range for # of entries per page
- Time: Log entries will be displayed at specific time zone (UTC or Local time)
- Logged Events: Displays the event information (for Code definition see [Creating Custom Events & Alarms](#))
- **Copy log to clipboard**: Will copy the System Log over to common Windows applications (Notepad, MS Outlook, Excel & Word). Simply select the command & Paste it in one of these applications.
- **Erase Log**: Will clear all the log entries & restart the System log from the time you select this option



- [Refresh Log](#): Refresh your view
- [>>](#): Go to the next page

SEE ALSO:

- [Advanced Settings](#)
- [Creating Custom Events](#)
- [E-Mail Alerts](#)
- [Reports](#)
- [Energy Meter](#)
- [Display Setup](#)
- [Upgrade G4K Software - Firmware Upgrade](#)

Creating Custom Events

The Custom Events window is used for configuring custom events. Unlike Compliance Configuration, where you are able to only configure power quality events, in this configuration you are free to define any type of event notification. Events can be triggered based on any measured parameters & conditioned by complex logical or mathematical functions.

The Custom Event Section is not related to Power Quality Event Section. The Events setup is based on a custom events engine that works parallel to the power quality events engine allowing the user to define tailored events according to his specific needs. All events triggered in the G4K BLACKBOX device series are stored in the logger (Flash Memory) which is displayed in the [System Log](#). Each event is coded & the following event types with their respective codes can be viewed in the [System Log](#) accordingly:

EVENT	EVENT CODE RANGE
System Events	1-200
User Custom Events	201-232
PQ & Compliance Events	233-300

In addition, all events are also stored in the PQZIP files and can be further analyzed in Elspec's PQSCADA/Investigator Software programs. Furthermore, you may choose to send [E-Mail Alerts](#) on the event and/or receive SMS Text Messages (See PQSCADA's F1 Help Wizard; follow the Components → Server → Configuration → SMS/Text procedure).

In the Custom Events window you will be able to:

- Perform Actions on the Events List
- Create General Event Conditions
- Define Single Type Conditions
- Multiple Type Conditions

CREATING CUSTOM EVENTS

- Access your G4K Device → log on as the Administrator (Manufacturer's Default Password is: 12345) → under Configuration → [Advanced](#) open the Custom Events Tab:

CONFIGURATION	
Device Setup	Advanced
Device Info	System Log
Time	<u>Custom Events</u>
Voltages & Frequency	PQZIP Recording
Currents	E-mail Alerts
Communication	Reports
Security	Energy Meter
Network	Display Setup
Serial Ports	Firmware Upgrade
PQ Compliance	
Power Compliance	
User Defined Page 1	
User Defined page 2	
User Defined page 3	

- In the Custom Events window select **New event** in order to create a New Event:

CONFIGURATION & DEFINITIONS:

- Event Preset: Select User Defined (Preset 1 & 2 used in other applications)
- Events List: See [Events List](#) for possible configurations
- Description: Used to set a meaningful name for the event
- Code: Event code # allocated automatically by the system from the available user events codes & viewed in the [System Log](#)
- Condition: An event is based on one or more conditions. There are two types of conditions [Single](#) & [Multiple](#). No matter what type of condition is linked to the event, its dependency is dictated by the condition ID string selected in the Condition selection box
- Edit Condition**: Will open the [Edit Condition](#) window
- Trigger: An event is basically a logic signal. Anytime a condition is not active, the event remains in a "0" state. When a condition is met, the event becomes "1" state (On Begin Only). The event remains on "1" state until the condition is de-activated (At the End Only). The trigger configuration field defines what situations will generate an event record. Notification is either on the beginning state, end state, or at both states (On Both Begin & End)
- Notify by E-Mail: Will send [E-Mail Alerts](#) as soon as the event is triggered

- **Phase Index:** This field should not be changed by user (reserved for future). In general this field defines how phase indication will be recorded with the event.
- **Phase Combination:** Event based on a condition of a 3 phase parameter can be further configured with an additional logic operator in between phases to further mask/enable the event generation. A 3 phase based condition (i.e 3 phase voltage lines compared to nominal voltage) will generate 3 parallel activation/deactivation statuses (0->1 changes). In such a 3 phase case the user has the control to determine whether an event is generated only when all 3 phases are activated (AND) or alternatively if at least one of the phases is activated (OR).
- **Minimal Duration:** The duration limit enables the user to limit notification of event based on its duration. In this case you will be able to set a minimum time & events with a duration of a lesser than specified time will not be triggered (this is true for the end of the event only; anyhow the beginning of the event will only be reported if it was configured).
- **Maximum Duration:** The duration limit enables the user to limit notification of an event based on its duration. In this case you will be able to set the maximum time, so that an event that elapses more time than defined won't be triggered.
- **Event Severity Base:** Each recorded event contains a severity factor. This severity factor is a number between 0 and 255, where 0 is no severity at all and 255 is top severity (For instance, PQ compliance events which are part of the Compliance module, uses this severity field to indicate how much voltage/frequency deviates from nominal and how significant the event was based on its duration). The Severity fields define how the events engine will compute a severity factor.
- **Cancel**: Will cancel your configuration
- **Save**: Will save your configuration
- **More** / **Less**: Will open / close the additional configuration settings
- To apply your changes select **Apply Changes** & you will receive the following message:

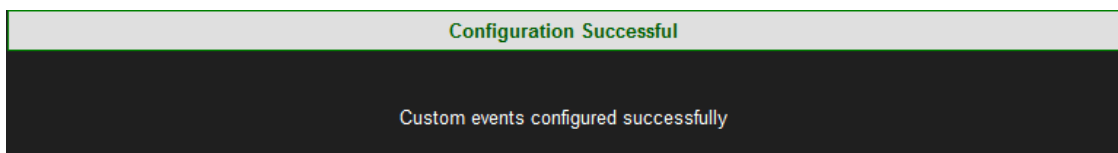

- To refresh your current view select **Refresh Data**

NOTE NOTE NOTE

- If you are not logged on as the Administrator, you will not be able to change any of these settings & you will receive the following error message in your attempt to do so:

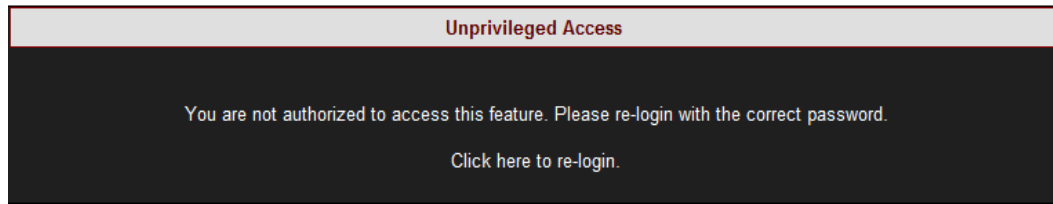

- Once you have signed on as the Administrator ensure that you select **Apply Changes** to actually affect your changes.
- Every underlined Configuration is accompanied with a Tool Tip (function explanation). In order to activate it, Right-click on the configuration:

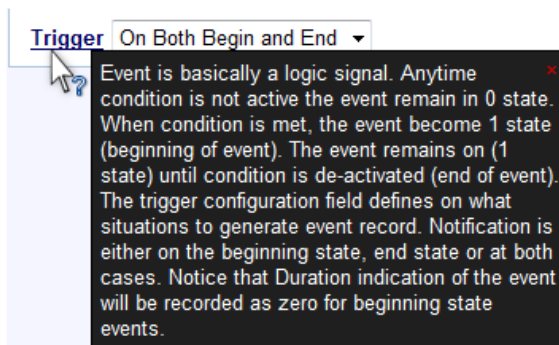

SEE ALSO:

- [Advanced Settings](#)
- [System Log](#)
- [E-Mail Alerts](#)
- [Reports](#)
- [Energy Meter](#)
- [Display Setup](#)
- [Upgrade G4K Software - Firmware Upgrade](#)

Events List

After you have [Created a Custom Event](#) the event will appear on the Events List & [System Log](#). The event will be coded & will appear with their respective codes (as per [Create Custom Events](#)). You may create 31 Custom events.

CONFIGURING EVENTS LIST ACTION

- Each event is preceded with a check-box, select the applicable events that you wish to perform actions for:

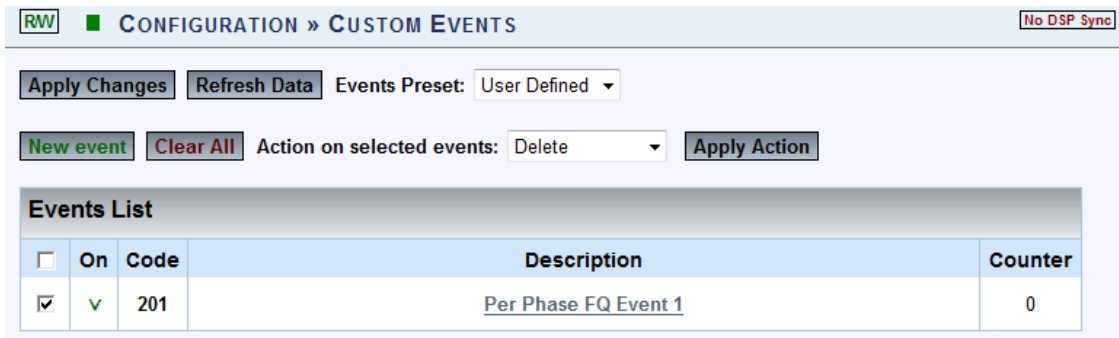

- Select **Clear All** to deselect the events that you marked on the Events List
- Choose Action on selected events:
 - Delete: Will enable you to delete the event in case you don't need it anymore
 - Enable: Will allow you to enable / activate the event (if disabled previously)
 - Disable: Will disable / deactivate the event until you wish to enable it at a later stage
 - Reset Counter: Will enable you to rerun the event at the configured trigger
- Select **Apply Action** to enforce selected actions for the applicable marked event(s) → select **OK**:

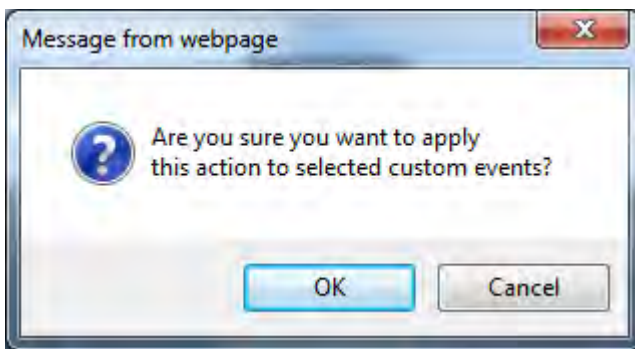

- The following success message will appear:

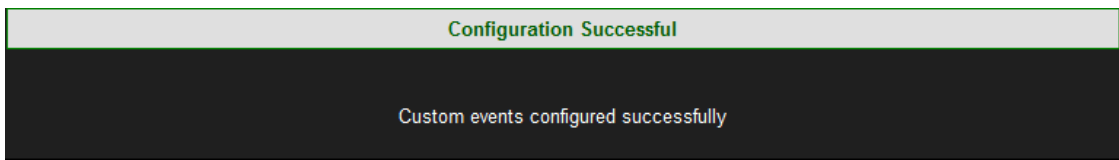

- Clicking on the event will open the event configuration itself & you may edit the configurations as you wish

NOTE NOTE NOTE

- If you are not logged on as the Administrator, you will not be able to change any of these settings & you will receive the following error message in your attempt to do so:

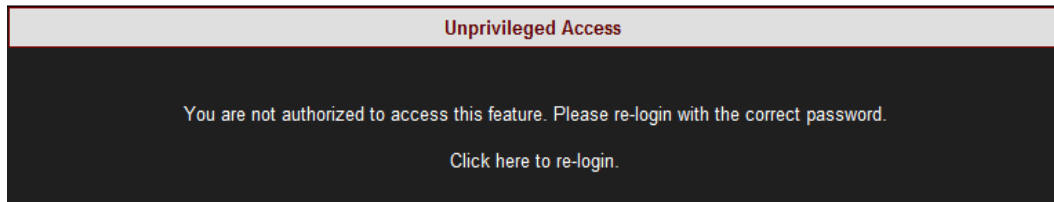

SEE ALSO:

- [Creating Custom Events](#)
- [Create Event Conditions](#)
- [Single Type Conditions](#)
- [Multiple Type Conditions](#)

Create Event Conditions

Codes 201 - 232 are used for configuring up to 31 different events that are fully customized events. A custom event is typically built from one or more logical/mathematical conditions. When the conditions are met, the event is triggered and the following information is generated and stored:

- Time Stamp of beginning
- Event Code number
- Duration of event
- Magnitude (A parameter value recorded during the event)
- Magnitude deviation (from the normal/configured value/threshold)
- Phases that were influenced
- Severity of the Event (value indicating how severe the event is)

Although the information implies a power related event, you are free to configure other type of events that are not related to specific power network parameters, such as digital input-based events or even temperature-based events and so on. (In such cases the Phases involved information should be left blank/ignored.)

Events can also be based on multiple conditions. For example: an event will be triggered should the voltage exceed threshold (x) and the outside (PT-100) temperature exceeds (x) limit.

This page contains buttons for applying changes/creating/deleting and performing various actions on selected events.

CREATE EVENT CONDITIONS

- Access your G4K Device → log on as the Administrator (Manufacturer's Default Password is: 12345) → under Configuration → [Advanced](#) open the [Custom Events Tab](#)

- After selecting [Create New Events](#) → naming the event in Description → select [Edit Condition](#) to open the Condition Window:

Condition Configuration [Cancel] [Save] [Less]

ID: (# 1) Type:

Based on: Parameter (X):

Magnitude Calculation: Averaging time:

Activation

Compare to: Parameter:

Deviation (D): % Operation:

Hold on time: Operation logic:

Second Deviation: % Second Operation:

Deactivation

Compare to: Parameter:

Deviation (D): % Operation:

Hold on time: Operation logic:

Second Deviation: % Second Operation:

- Name the Condition & you will need to create a [Single Condition](#) in order to create [Multiple Conditions](#):
 - ID: The ID Condition is identified by a text ID. Two conditions cannot be set to the same ID string.
 - The Single-Type Condition: Defined as the result of some rule (mathematical operation on some system parameters). For instance, a percentage voltage drops below the threshold or a change of digital input & so on. The condition has 2 logic states, Activated (1) and Deactivated (0). Transition to each state is fully configured by the user.
 - A Multiple-Type Condition: Is the combination of 2 other sub conditions. A Multiple-type condition must be linked to 2 sub conditions, each of these 2 sub conditions can be either Multiple or Single type. Therefore, the Multiple-type condition can be used to create a complex hierarchy of conditions.
- Go to the next steps creating [Single Conditions](#) &/or [Multiple Conditions](#)

SEE ALSO:

- [Creating Custom Events](#)
- [Events List](#)

Single Type Conditions

As mentioned previously Single Type Conditions are used to define the result of an occurrence (example - voltage drops below the threshold) or a change of digital input & so on. You will need to configure the condition, including the transition of the condition from the Activated to the Deactivated State.

CONFIGURE SINGLE TYPE CONDITIONS

- Access your G4K Device → log on as the Administrator (Manufacturer's Default Password is: 12345) → under Configuration → [Advanced](#) open the [Custom Events Tab](#)
- After selecting [Create New Events](#) → naming the event in Description → select [Edit Condition](#) to open the Condition Window
- Select Single for the Type → open the [More](#) / [Less](#) in order to view the additional configuration options:

The screenshot shows the 'Condition Configuration' window with the following settings:

- Condition Configuration** (Title bar)
- ID:** Per Phase FQ Condition 1 (# 1)
- Type:** Single
- Based on:** Per phase [V/I], Frequency
- Parameter (X):** I1 RMS
- Magnitude Calculation:** Max.
- Averaging time:** 200 ms
- Activation** (Section Header)
- Compare to:** Parameter
- Parameter:** Nominal I
- Deviation (D):** 10 %
- Operation:** $100 * ((X-V)/V) >= D$
- Hold on time:** 200 ms
- Operation logic:** And
- Second Deviation:** 0 %
- Second Operation:** No op
- Deactivation** (Section Header)
- Compare to:** Parameter
- Parameter:** Nominal I
- Deviation (D):** 10 %
- Operation:** $100 * ((X-V)/V) < D$
- Hold on time:** 200 ms
- Operation logic:** And
- Second Deviation:** 0 %
- Second Operation:** No op

CONFIGURATIONS:

- **Based on:** The parameter selection to base your condition on
- **Parameter (X):** Used to select the specific parameter from a previously selected group. The selected parameter will be used as the "X" variable in the condition rules (operation)
- **Magnitude Calculation:** Determines the way the condition engine will compute the resulting magnitude of change in accordance to its set of rules. For example if defined a voltage change rule, where now voltage ("X") is 280V while its reference ("V") is 230V, the computed deviation now will be 21% - this is the instant deviation, but what happens if event continues and the next value sampled is 260V? Now the deviation is only 13% so what values should be reported? The "Magnitude calculation" field defines how the value is being computed. It is either by saving the maximum deviation measured or by average in between all values measured during the event
- **Averaging Time:** Setting averaging time enables the user to extend the sampling interval. For instance if user selected "3 phase differential V" parameter, the typical time is 200[ms] (per IEC-61000-4-30). Yet, if the user change it to 3sec, it means the value will be averaged and a sample will be taken only every 3 seconds, meaning that quick rapid change of voltage will be smoothed by the averaging operation and would not be detected
 - **Activation Section:** Used to configure the rules that will be applied to cause real-time activation of the condition (change from 0 -> 1). For example, if you set the following: Voltage RMS 1 (X = V1), compare to is set to the configured Nominal voltage (say, V = 230V), Deviation is set 10 (D = 10%) and Operation is set $100 * (|X - V| / V) \geq D$, the condition will be activated when the RMS voltage of channel 1 goes 10% above or 10% below nominal voltage
 - **Deactivation Section:** Used to configure the rules that will be applied to cause real-time de-activation of the condition (change from 1 -> 0). For example, if you set the following: Voltage RMS 1 (X = V1), Compare to is set to the configured Nominal voltage (say, V = 230V), Deviation is set 10 (D = 10%) and Operation is set $100 * (|X - V| / V) < D$, the condition will be de-activated when the RMS voltage of channel 1 goes below 10% deviation from nominal
- **Compare to:** Used to select the type of reference value ("V") to compare to the X parameter value
- **Parameter:** Reference to system parameter such as nominal voltage value
- **Deviation ("D"):** Defines the value used in the operation formula. Notice that some operations do not contain deviation; in such cases the deviation configuration is not in use

- **Operation:** Defines the rule or mathematical operation to apply for Activation or Deactivation of condition. User Value enables the user to edit his own reference value
- **Operation Logic (And / Or):** This operation logic field defines the logic to be applied between 2 operations for enabling activation or deactivation in accordance. By using two operations & a logical operation in between, the user can define a more complex condition rule
- **Second Deviation:** This field defines the additional Deviation ("D"%) value used in the operation formula. Note that some operations do not contain a deviation, & in these instances the configured deviation is not utilized
- **Second Operation:** This operation list defines the additional mathematical operation to apply for Activation/Deactivation of condition
- Select / to Save / Cancel your configuration in Condition Configuration
- You will receive the following Success Message:

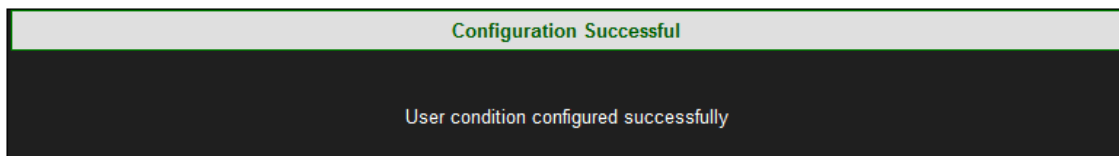

- Proceed either to creating [Multiple Type Conditions](#) or conclude your configuration as per [Create Custom Events](#)

NOTE NOTE NOTE

- If you are not logged on as the Administrator, you will not be able to change any of these settings & you will receive the following error message in your attempt to do so:

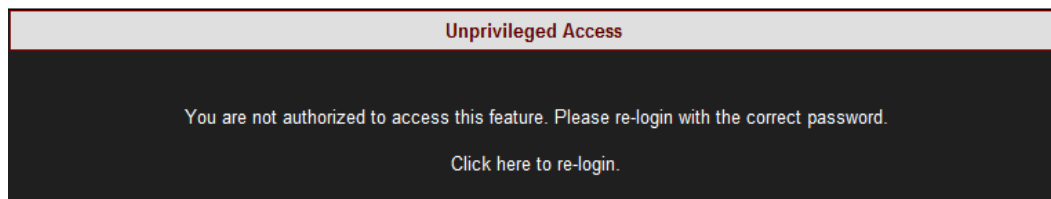

SEE ALSO:

- [Create Custom Events](#)
- [Events List](#)

Multiple Type Conditions

As mentioned previously, Multiple Type Conditions is the combination of 2 other sub conditions. It needs to be linked to 2 sub conditions, whereas each 2 sub conditions can be either Multiple or [Single type](#). Therefore, you need to configure at least two [Single types](#) of conditions prior to proceeding in creating a hierarchy of Multiple Conditions.

CONFIGURE MULTIPLE TYPE CONDITIONS

- Access your G4K Device → log on as the Administrator (Manufacturer's Default Password is: 12345) → under Configuration → [Advanced](#) open the [Custom Events Tab](#)
- From the listed events in the [Events List](#) select the applicable event with 2 or more [Single T ype C onditions](#) → & select **Edit Condition** to open the Condition Window
- Select Multiple for the Type:

Condition configuration Cancel Save More

ID: (# 3) Type:

Condition A: Edit subcondition

Condition B: Edit subcondition

Logic: Magnitude combination:

Configuration Options:

- Condition A: Is used to select ID of first sub-condition
 - Condition B: Is used to select ID of second sub-condition
 - Logic: Is used to define the combined logic state between the two sub-conditions A and B
 - Magnitude Combination: Instructs the events engine how to compute the Magnitude resulting from a combined condition. For instance, say condition A and condition B are both voltage parameters. In this case, selecting Avg. (Average) or Max (Maximum) is practical. However if condition A is voltage and condition B is current, then AVG or MAX is irrelevant, while an A-only option is more practical (meaning only magnitude of voltage from condition A will be taken)
- Select **Save** / **Cancel** to Save / Cancel your configuration in Condition Configuration

- You will receive the following Success Message:

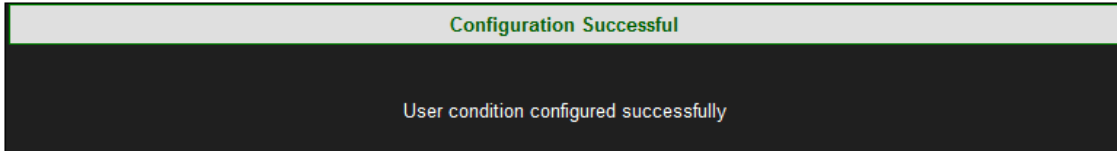

- Conclude your configuration as per [Create Custom Events](#)

NOTE NOTE NOTE

- If you are not logged on as the Administrator, you will not be able to change any of these settings & you will receive the following error message in your attempt to do so:

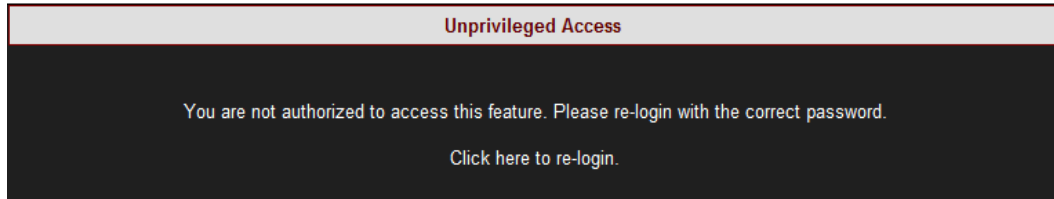

SEE ALSO:

- [Create Custom Events](#)
- [Events List](#)

E-Mail Alerts

Your G4K BLACKBOX can be configured to send E-Mail alerts to any recipient(s) entered in the "To" text box. This configuration also allows you to choose which alert(s) you would like to be notified on from a wide range of configurations, i.e.: [System](#), [Connections](#), [Firm Ware Updates](#), [PQZIP](#), [Compliance Events](#), [PQ Events](#) & [Custom Events](#).

CONFIGURE THE G4K TO SEND E-MAIL ALERTS

- Access your G4K Device via Elspec's Web Interface → log on as the Administrator (Manufacturer's Default Password is: 12345) → select the Configuration Tab
- Under the Advanced section select E-Mail Alerts:

CONFIGURATION	
Device Setup	Advanced
Device Info	System Log
Time	Custom Events
Voltages & Frequency	PQZIP Recording
Currents	<u>E-mail Alerts</u>
Communication	Reports
Security	Energy Meter
Network	Display Setup
Serial Ports	Firmware Upgrade
PQ Compliance	
Power Compliance	
User Defined Page 1	
User Defined page 2	
User Defined page 3	

- The E-Mail Alerts window will now open & you need to enter the exact E-Mail Address(s) (without spaces, for multiple E-Mails enter a ; as a separator between the E-Mails). Make sure that you are connected to the pre-configured [SMTP server](#) that will have the e-mails already setup within the server:

E-mail Configuration

'TO' address:

- Under each section (you may collapse / expand with) select the Configuration on which you will need to send/receive E-Mail Alerts:

System:

System

<input checked="" type="checkbox"/> Power Up	<input checked="" type="checkbox"/> Watchdog Reset
<input checked="" type="checkbox"/> Power Loss	<input checked="" type="checkbox"/> System Startup
<input checked="" type="checkbox"/> Shutdown Started	<input checked="" type="checkbox"/> Shutdown Done
<input checked="" type="checkbox"/> Shutdown on Power Loss	<input checked="" type="checkbox"/> Shutdown on Error
<input checked="" type="checkbox"/> User Shutdown	<input checked="" type="checkbox"/> Event Log Erased
<input checked="" type="checkbox"/> Parameter Block Corrupted	<input checked="" type="checkbox"/> Read Meter Log File End
<input checked="" type="checkbox"/> Voltage Dropdown	<input type="checkbox"/> Reserved

Connections:

Connections

<input checked="" type="checkbox"/> HTTP Connected	<input checked="" type="checkbox"/> TCPIP Connected
<input checked="" type="checkbox"/> OPC Connected	<input checked="" type="checkbox"/> Serial Connected
<input checked="" type="checkbox"/> FTP Login	<input checked="" type="checkbox"/> Telnet Login
<input checked="" type="checkbox"/> Main SMTP	Reserved
<input checked="" type="checkbox"/> IP Changed	<input checked="" type="checkbox"/> Time Synchronized
<input checked="" type="checkbox"/> Connection Closed	<input checked="" type="checkbox"/> Network Reset

FW Update:

FW Update

<input checked="" type="checkbox"/> FW Update Started	<input checked="" type="checkbox"/> FW Update OK
<input checked="" type="checkbox"/> New FW Launched	<input checked="" type="checkbox"/> FW Update Failure

PQZIP:

PQZip	
<input checked="" type="checkbox"/> PQZip Enabled	<input checked="" type="checkbox"/> PQZip Disabled
<input checked="" type="checkbox"/> PQZip Flushed	<input checked="" type="checkbox"/> PQZip Data Clear
<input checked="" type="checkbox"/> PQZip Events Dropped	<input checked="" type="checkbox"/> PQZip Start Failed
<input checked="" type="checkbox"/> Compact Flash Format	<input checked="" type="checkbox"/> CF Format Failed

Compliance Events:

Compliance Events	
<input checked="" type="checkbox"/> Evaluation Started	<input checked="" type="checkbox"/> Evaluation Stopped
<input checked="" type="checkbox"/> Evaluation State Changed	<input checked="" type="checkbox"/> Report Generation

PQ Events:

PQ Events	
<input type="checkbox"/> Voltage Frequency	<input checked="" type="checkbox"/> Supply Voltage Variations
<input type="checkbox"/> Supply Voltage Dips	<input checked="" type="checkbox"/> Short Interruptions
<input type="checkbox"/> Temporary Overvoltage	<input type="checkbox"/> Supply Voltage Unbalance
<input type="checkbox"/> Harmonic Voltage	<input type="checkbox"/> Flicker Severity
<input type="checkbox"/> Rapid Voltage Changes	<input checked="" type="checkbox"/> Long Interruptions

Custom Events:

Custom Events	
<input checked="" type="checkbox"/> Event 201	

- Select **Send Test Alert** to send a Test E-Mail
- To apply your changes select **Apply Changes** ➔ **Refresh Data** to review them

NOTE NOTE NOTE

- If you are not logged on as the Administrator, you will not be able to change any of these settings & you will receive the following error message in your attempt to do so:

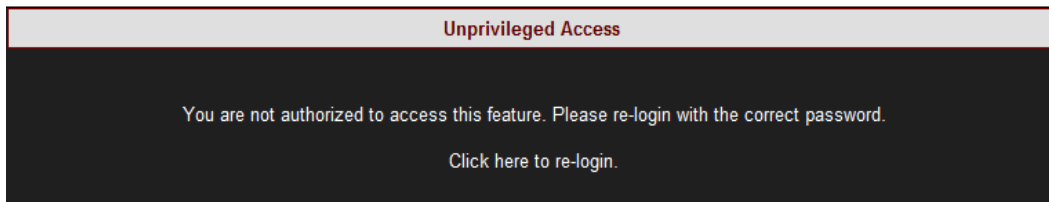

- Once you have signed on as the Administrator ensure that you select [Apply Changes](#) to actually affect your changes.
- Ensure that you are connected to the pre-configured [SMTP server](#) that will have the e-mails already setup within the server.

SEE ALSO:

- [Advanced Settings](#)
- [System Log](#)
- [Creating Custom Events](#)
- [Reports](#)
- [Energy Meter](#)
- [Display Setup](#)
- [Upgrade G4K Software - Firmware Upgrade](#)

Reports

The G4K BLACKBOX saves & copies reports over to its internal Compact Flash memory. This report includes 2 log types namely: Energy & Parameter Logs. As in many cases this may include a vast amount of information. Therefore it is recommended that you:

1. Configure the unit to send you [E-Mail Alerts](#) (mark Report Generation under Compliance Events) once it has concluded the report.
2. You retrieve the reports from the G4K's CF Memory via FTP Server. Access the FTP server via Elspec's Search Utility & the file is located under Reports. (Any user may copy the log over to this location). Retain the reports on the CF memory only when necessary in order to not occupy unnecessary disc space.

USING THE METER READING LOG

In this window you will be able to configure the report to include modes for either [Energy](#) or [Parameter](#) logs

- Access your G4K Device via Elspec's Web Interface → log on as the Administrator (Manufacturer's Default Password is: 12345) → select the Configuration Tab
- Under the Advanced section select Reports:

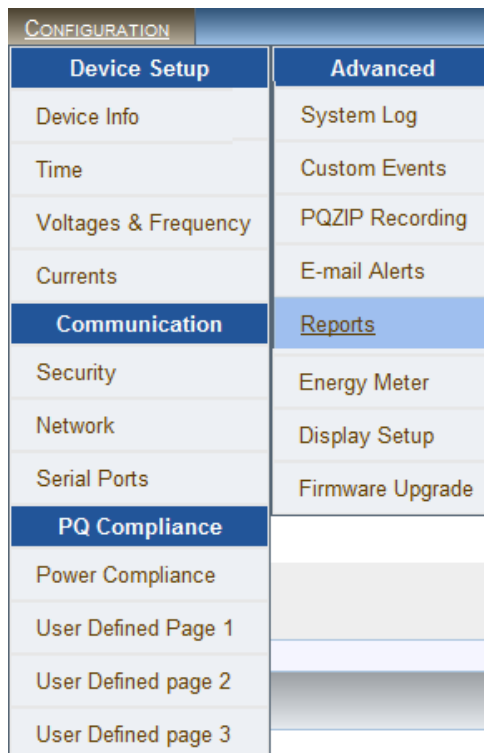

CONFIGURATION	
Device Setup	Advanced
Device Info	System Log
Time	Custom Events
Voltages & Frequency	PQZIP Recording
Currents	E-mail Alerts
Communication	Reports
Security	Energy Meter
Network	Display Setup
Serial Ports	Firmware Upgrade
PQ Compliance	
Power Compliance	
User Defined Page 1	
User Defined page 2	
User Defined page 3	

- Select:

RO ■ CONFIGURATION » REPORTS No DSP Sync

Apply Changes Refresh Data

Meter Readings Log

Mode	Duration	Log Restart	(Local: 15:00, every 1 of month)
<input type="checkbox"/> Energy <input type="checkbox"/> Parameter	1/Month	UTC: 12:00, every 1 of month	

- Mode [Energy](#) or [Parameter](#)
 - Duration: 1 Day, 1 Month, 1 Week
 - Log Restart: At - Time Local to UTC Time / Every - 1-25th of the Month
- To apply your changes select [Apply Changes](#) → [Refresh Data](#) to review them

NOTE NOTE NOTE

- If you are not logged on as the Administrator, you will not be able to change any of these settings & you will receive the following error message in your attempt to do so:

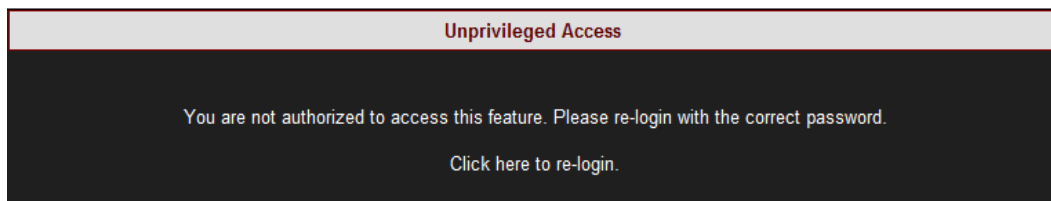

- Once you have signed on as the Administrator ensure that you select [Apply Changes](#) to actually affect your changes.

SEE ALSO:

- [Advanced Settings](#)
- [System Log](#)
- [Creating Custom Events](#)
- [E-Mail Alerts](#)
- [Energy Meter](#)
- [Display Setup](#)
- [Upgrade G4K Software - Firmware Upgrade](#)

Energy Mode

The information included in the [Report](#) includes data from the total [Energy Meter](#). The information is saved on the compact flash & retrievable from the FTP under: /CF_UPMB/Reports & is saved in a .csv file format. As such the report can be viewed in Excel & be sent as an E-Mail attachment. The values that are saved in this report include:

- Kwh In
- Kwh Out
- KVArh In
- KVArh Out
- KVAh

NOTE NOTE NOTE

The values of the total energy meter are saved in the PQZIP files even if the Meter Readings Log is disabled.

SEE ALSO

- [How to create Reports](#)
- [Parameter Mode](#)

Parameter Mode

The information included in the [Report](#) includes data from PQC compliance. The information is saved on the compact flash & retrievable from the FTP under: /CF_UPMB/Reports & is saved in PDF / Excel (According to the Applicable Standard) file format. As such the report can be viewed in Excel & be sent as an E-Mail attachment. The values that are saved in this report include:

- Kw (Power): Average, standard deviation, maximum and minimum values
- Frequency: Average, standard deviation, maximum and minimum values
- KVAR: Average, standard deviation, maximum and minimum values

NOTE NOTE NOTE

The parameter log can be customized to include any other three parameters. For this configuration please contact your local Elspec representative.

SEE ALSO

- [How to create Reports](#)
- [Energy Mode](#)

Energy Meter

The G4K BLACKBOX Device Series is equipped with 3 Energy Meters for continuously recording & measuring all the electrical energy. The meters measure:

- Current Period,
- Total Consumption &
- Demand

CONFIGURING THE ENERGY CALCULATIONS FOR THE ENERGY METERS

In this window you will be able to configure the energy calculations of these meters by time & the method of averaging:

- Access your G4K Device via Elspec's Web Interface → log on as the Administrator (Manufacturer's Default Password is : 12345) → select the Configuration Tab
- Under the Advanced section select the Energy Meter Tab:

CONFIGURATION	
Device Setup	Advanced
Device Info	System Log
Time	Custom Events
Voltages & Frequency	PQZIP Recording
Currents	E-mail Alerts
Communication	Reports
Security	<u>Energy Meter</u>
Network	Display Setup
Serial Ports	Firmware Upgrade
PQ Compliance	
Power Compliance	
User Defined Page 1	
User Defined page 2	
User Defined page 3	

- The Energy Intervals window for the Energy Meters will now open:

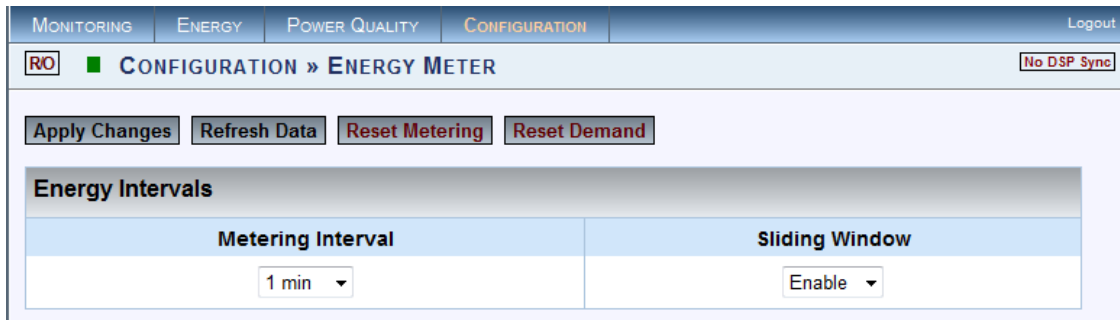

In the 2 Sections Select:

- Metering Interval:** This sets the meters to measure energy according to a preset interval (1, 2, 5, 10, 15, 30 & 60 minutes)
- Sliding Window (Applicable For The Demand Meter):** The energy is calculated using moving average time intervals (1 second). Options:
 - Enable:** The energy is calculated using a sliding window. The figure below illustrates the time increment as 1 second:

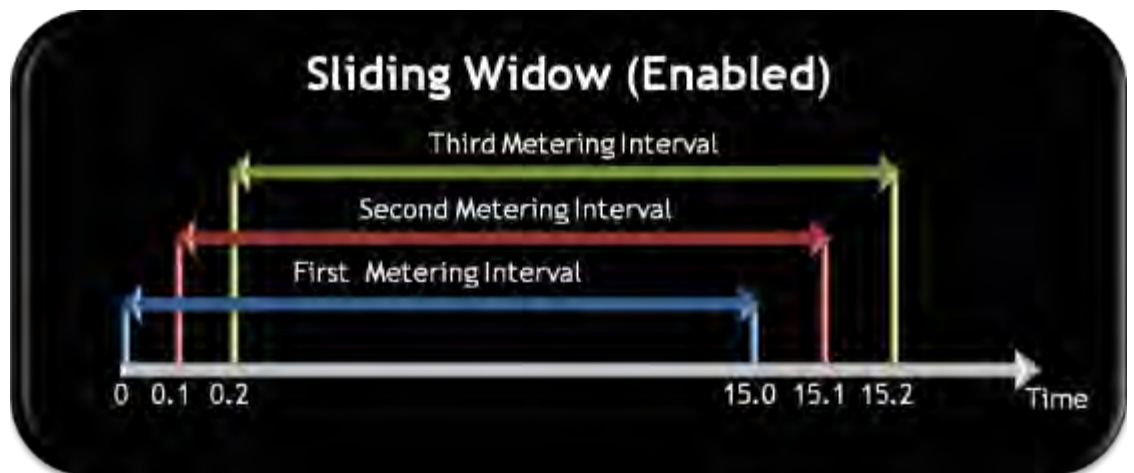

- Disable:** The energy is calculated using fixed interval for each meter - illustration:

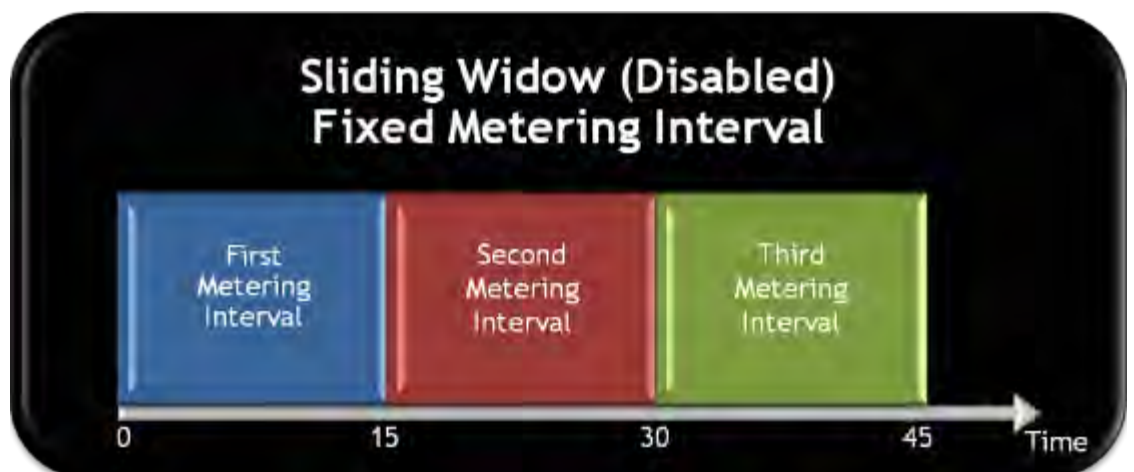

- To ensure that you have reset the All the Meters select **Reset Metering**
- To reset only the Demand Meter select **Reset Demand**
- To apply your changes select **Apply Changes** → **Refresh Data** to review them

NOTE NOTE NOTE

- If you are not logged on as the Administrator, you will not be able to change any of these settings & you will receive the following error message in your attempt to do so:

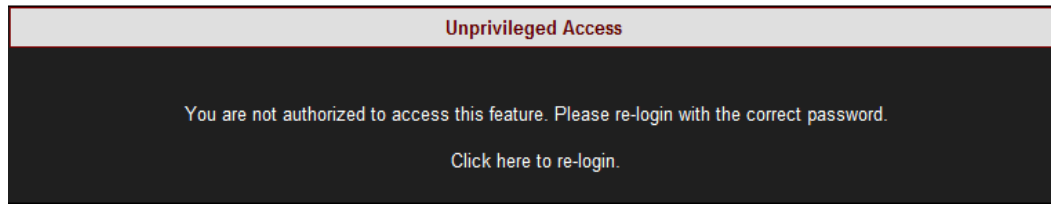

- Once you have signed on as the Administrator ensure that you select **Apply Changes** to actually affect your changes.

SEE ALSO:

- [Advanced Settings](#)
- [System Log](#)
- [Creating Custom Events](#)
- [E-Mail Alerts](#)
- [Reports](#)
- [Display Setup](#)
- [Upgrade G4K Software - Firmware Upgrade](#)

Display Setup

The Display Setup page enables you to customize your G4K BLACKBOX to display regional & generic display preferences for both Elspec's Web Interface & for your G4100 RDU.

- Access your G4K Device via Elspec's Web Interface → log on as the Administrator (Manufacturer's Default Password is: 12345) → select the Configuration Tab
- Under the Advanced section select the Display Setup Tab:

CONFIGURATION	
Device Setup	Advanced
Device Info	System Log
Time	Custom Events
Voltages & Frequency	PQZIP Recording
Currents	E-mail Alerts
Communication	Reports
Security	Energy Meter
Network	<u>Display Setup</u>
Serial Ports	Firmware Upgrade
PQ Compliance	
Power Compliance	
User Defined Page 1	
User Defined page 2	
User Defined page 3	

- The Display Setup window will now open:

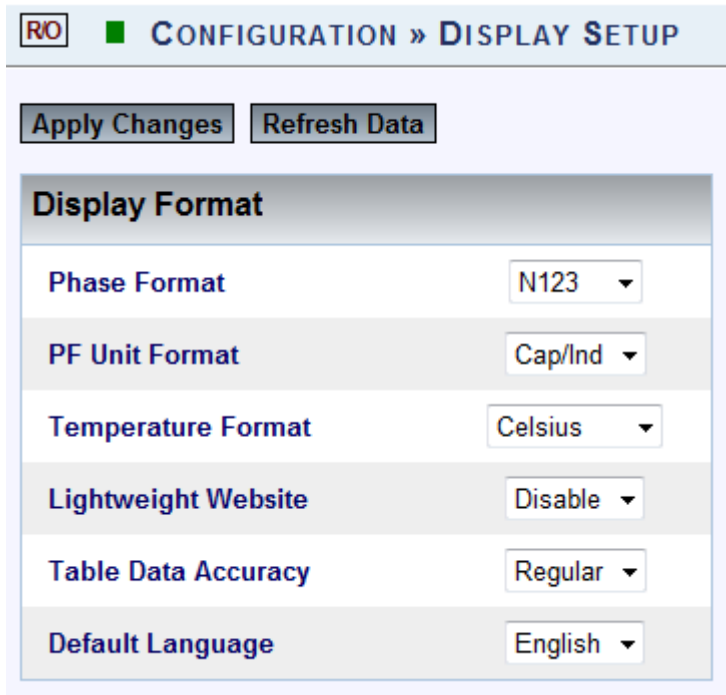

RO ■ CONFIGURATION » DISPLAY SETUP

Apply Changes Refresh Data

Display Format

Phase Format	N123 ▾
PF Unit Format	Cap/Ind ▾
Temperature Format	Celsius ▾
Lightweight Website	Disable ▾
Table Data Accuracy	Regular ▾
Default Language	English ▾

Configuration Options:

- Phase Format: Format that will be used to indicate phases. For example: V1,V2,V3 ; VA,VB,VC; Vx Vy, Vz; etc.
 - PF Unit Format: Format that will be used to indicate the PF Unit. For example: For Capacitive/Inductive select Cap/Ind
 - Temperature Format: Preferred temperature measurements in either Celsius / Fahrenheit
 - Lightweight Website: When disabled, the web interface doesn't use any images (and also flash on the login page) in order to speed up your connection. It is recommended when the network connection to the unit is weak.
 - Table Data Accuracy: Extra will extend the display to 7 digits (230.5612) & Regular will extend the display to 5 digits (230.56)
 - Default Language: Select your default system language
- To apply your changes select **Apply Changes** ➔ **Refresh Data** to review your changes

NOTE NOTE NOTE

- If you are not logged on as the Administrator, you will not be able to change any of these settings & you will receive the following error message in your attempt to do so:

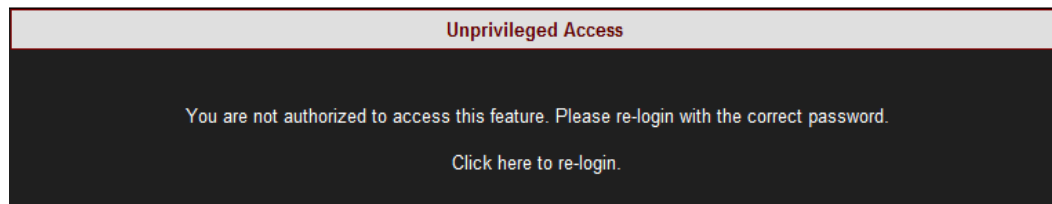

- Once you have signed on as the Administrator ensure that you select [Apply Changes](#) to actually affect your changes.

SEE ALSO:

- [Advanced Settings](#)
- [System Log](#)
- [Creating Custom Events](#)
- [E-Mail Alerts](#)
- [Reports](#)
- [Energy Meter](#)
- [Upgrade G4K Software - Firmware Upgrade](#)

Upgrade G4K Software - Firmware Upgrade

The internal software of the G4K BLACKBOX device series is named Firmware (FW). On every upgrade (every couple of months) Elspec will announce the new release accompanied by the features, benefits, access & upgrade instructions. The latest version is located on [Elspec's Website](#). It is recommended that you take advantage of every new upgrade, but it is not compulsory. In the Firmware Upgrade window you will be able to:

- [Upgrade the FW directly using the FTP, or](#)
- [Upgrade the FW locally \(Recommended\)](#)

ACCESS THE FIRMWARE UPGRADE WINDOW

- Access your G4K Device via Elspec's Web Interface → log on as the Administrator (Manufacturer's Default Password is: 12345) → select the Configuration Tab
- Under the Advanced section select the Firmware Upgrade Tab:

CONFIGURATION	
Device Setup	Advanced
Device Info	System Log
Time	Custom Events
Voltages & Frequency	PQZIP Recording
Currents	E-mail Alerts
Communication	Reports
Security	Energy Meter
Network	Display Setup
Serial Ports	<u>Firmware Upgrade</u>
PQ Compliance	
Power Compliance	
User Defined Page 1	
User Defined page 2	
User Defined page 3	

- The Firmware Upgrade window will now open:

IN THE BANKS SECTION:

The BL ACKBOX implements a comprehensive Firmware management mechanism designed to ensure a failure-free field upgrading functionality. The mechanism ensures that at any time there are two Firmware images available, where only one are active (running). The user may select which one of the two banks is the active bank. When the user initiates a Firmware upgrade, the newly added Firmware will load into the inactive bank. Once the process of uploading the new Firmware is completed, the unit will reboot from the inactive bank, turning it into the active bank.

OPTIONS & DISPLAY

- **Active Bank:** Indicates which Firmware Bank is actually in use. Select the applicable version Bank A/B
- **Bank A/B Version:** Displays a Bank's Firmware and condition. A numeric only Firmware name means it's a valid Firmware, which is ready to use. In some situations the Firmware could be further marked with a prefix character to identify a Firmware status. The table below describes status prefixes available:

PREFIX	STATUS
*	The Firmware was upgraded and a reboot is pending to activate the image for the first time. The user is free to initiate a reboot manually to complete the upgrading procedure.
F	The Firmware image failed to complete the initialization process successfully. The Firmware was declared as “Faulty”, another bank is being used.
W	The Firmware bank is being upgraded at the moment, wait for the completion.
E	The bank is empty.

NOTE NOTE NOTE

Should Firmware 0.4.07.0 be found faulty/damaged/corrupted it will appear as F0.4.07.0 on the Bank A/B version field. In such a case it is recommended to check if the Firmware file is authentic and attempt to upgrade it again.

SEE ALSO:

- [Advanced Settings](#)
- [System Log](#)
- [Creating Custom Events](#)
- [E-Mail Alerts](#)
- [Reports](#)
- [Energy Meter](#)
- [Display Setup](#)

Upgrade the FW Using FTP

An alternative option of upgrading your instrument is by using an FTP (File Transfer Protocol) interface. The BLACKBOX employs an FTP client module which is capable of downloading a Firmware image file from an external FTP server automatically. Prior to using this option, ensure that you have [Established Communication](#) & that your G4K Unit has been Configured for FTP access.

FTP UPGRADE

The FTP firmware upgrade functionality is configured in the FTP Firmware Upgrade section. The factory default configuration settings define an ELSPEC Corporate FTP server which is loaded with the latest released firmware. Alternatively, any other FTP server could be used. We recommend Filezilla, a free FTP server (<http://filezilla-project.org/>) or similar.

- Access your G4K Device via Elspec's Web Interface → log on as the Administrator (Manufacturer's Default Password is: 12345) → select the Configuration Tab → Advanced → Firmware Upgrade Tab
- In the FTP Firmware Upgrade Section insert:

FTP Firmware Upgrade	
FTP Server	<input type="text" value="212.143.246.204"/>
FTP Username	<input type="text" value="ELSPEC"/>
FTP Password	<input type="text" value="elspecelspec"/>
Firmware Filename	<input type="text" value="G4k.bin"/>

- FTP Server: The IP address of the external FTP server where the firmware file is located. The default setting is: 212.143.246.204 which is the ELSPEC's FTP server which is loaded with a latest released Firmware
 - Firmware User-Name: The [User-Name to login](#) to the FTP server
 - Firmware Password: The [Password to login](#) to the FTP server
 - Firmware Filename: As default, the latest Firmware located under Elspec's FTP server is G4k.bin
- To apply your changes select **Upgrade FW** after which you'll receive a success message & the unit will automatically restart on completion of the upgrade:

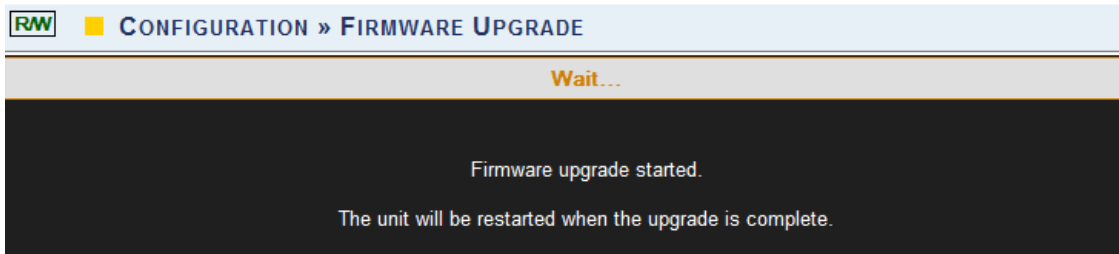

- After the restart, select [Apply Changes](#) to apply your changes
- In order to refresh your screen & view the changes select [Refresh Data](#)

NOTE NOTE NOTE

- If you are not logged on as the Administrator, you will not be able to change any of these settings & you will receive the following error message in your attempt to do so:

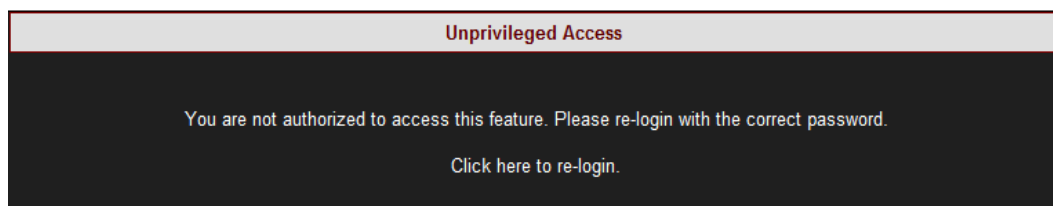

- Once you have signed on as the Administrator ensure that you select [Apply Changes](#) to actually affect your changes.

SEE ALSO:

- [About Firmware Upgrade](#)
- [Upgrade - HTTP](#)

Local FW Upgrade

Probably, the simplest way of upgrading your instrument is by using the Local Upgrade functionality.

OPEN THE LOCAL UPGRADE FUNCTIONALITY

- Access your G4K Device via Elspec's Web Interface → log on as the Administrator (Manufacturer's Default Password is : 12345) → select the Configuration Tab → Advanced → Firmware Upgrade Tab
- Go to the Local Image Firmware Upload Section:

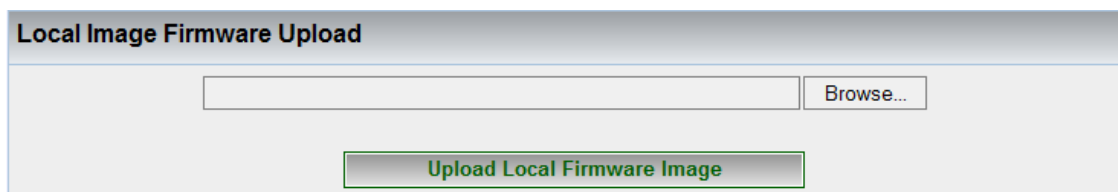

- Select the **Browse...** search for the file on your local computer & select **Open** :

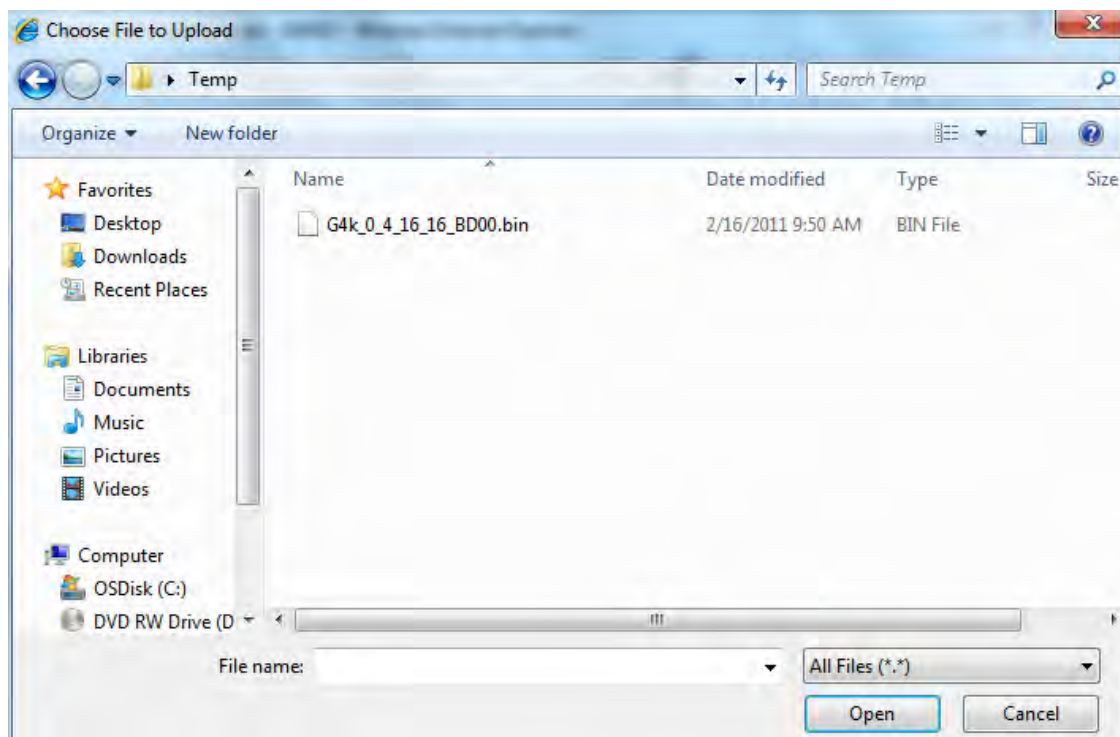

- Select the **Upload Local Firmware Image** button to initiate the upgrade process:

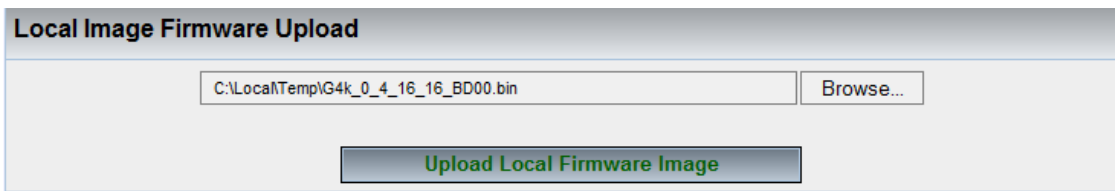

- For your changes to be taken into affect select **Upgrade FW** after which you'll receive a success message & the unit will automatically restart on completion of the upgrade:

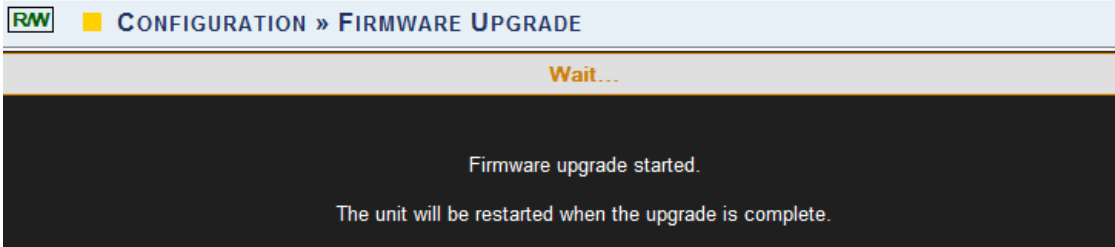

- After the restart, select **Apply Changes** to apply your changes
- In order to refresh your screen & view the changes select **Refresh Data**

NOTE NOTE NOTE

- If you are not logged on as the Administrator, you will not be able to change any of these settings & you will receive the following error message in your attempt to do so:

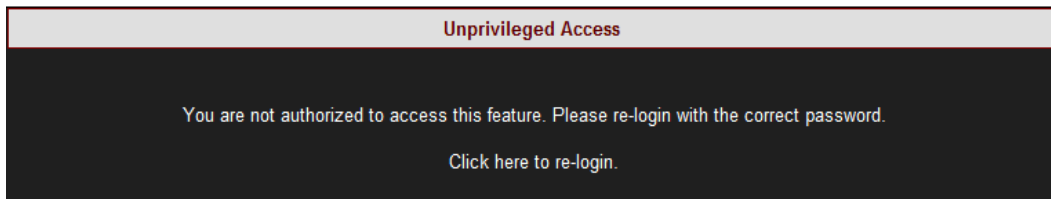

- Once you have signed on at the Administrator ensure that you select **Apply Changes** to actually affect your changes.

SEE ALSO:

- [About Firmware Upgrade](#)
- [Upgrade - FTP](#)

Optional Installations & Disconnections

Attach The PT100 Temperature Connection

The DSP Module of the G4K is equipped with an external connection terminal for a PT100 Temperature Sensor. The BLACKBOX is also equipped with two internal temperature sensors, one in the DSP module and the second in the PS Module. The PT100 temperature sensor is an optional device. The temperature module from the DSP provides reference for compensation of temperature related reading offsets. Attachment procedure:

- Remove the [PT100 Temperature Sensor](#) provided with the G4K BLACKBOX unit:



- Connect the sensor to the DSP Module of the G4K:



SEE ALSO

- [Connect Power Over Ethernet](#)
- [Detach the Voltage Terminal Block Connector](#)

Connect Power Over Ethernet

PoE is a standard for feeding DC power to the RTU using the network LAN cable without the need for an additional external power. The G4K contains 2 ports that support PoE:

- The LAN1 Port can receive PoE supply for the G4K unit from a remote source, thus enabling the BLACKBOX to operate. It is suggested that the LAN1 PoE be used as an alternative backup power source. To activate this PoE option, connect an RJ45 jack with PoE to the marked LAN1 PoE In on the CPU module.
- The LAN2/LCD Port has PoE output capability for supplying power to other devices. The LAN2/LCD port can supply power for the Elspec G4100 Display unit. To activate this PoE option, connect an RJ45 jack to the port marked LAN2/LCD PoE Out on the CPU module, connecting the other end of the RJ45 jack to the G4100 [RDU](#).
Procedure:
 - Connect a LAN to the indicated ports on the G4K / PoE Injector / G4100:

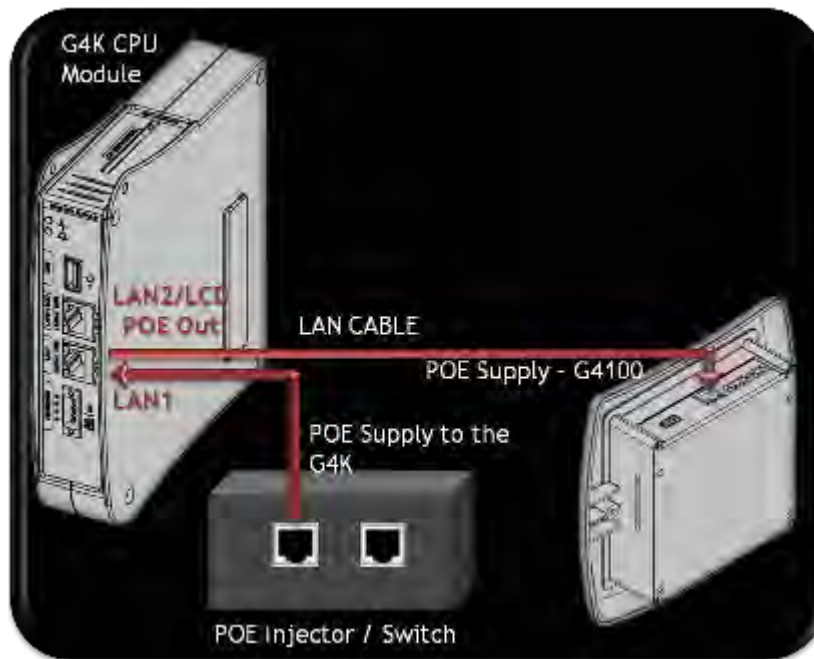

SEE ALSO

- [Attach The PT100 Temperature Connection](#)
- [Detach the Voltage Terminal Block Connector](#)

Detach the Voltage Terminal Block Connector

If you need to disconnect the unit from the measured voltages, you need to detach the [Voltage Terminal Block Connector](#). To detach the voltage terminal block connector:

- Loosen the screws anchoring the block in place
- Slide the orange thumb locks out
- Pull out the terminal block

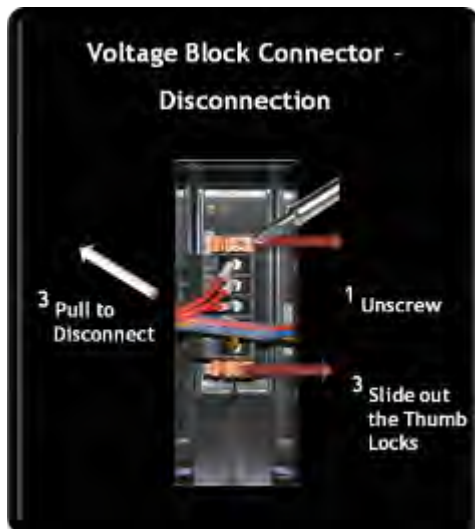

SEE ALSO

- [Attach The PT100 Temperature Connection](#)
- [Connect Power Over Ethernet](#)

About Elspec's Search Utility

Elspec's Search Utility is a small, yet powerful tool that allows searching for multiple G4K BLACKBOX device IP addresses sharing the same local LAN. The Elspec Search makes use of UDP broadcasting, sending a "please respond" broadcast request to all devices on the LAN and displaying the resultant list of all devices responding to it.

When a [1st Time Connection has been Established](#) between a unit and the host computer, the internal Web Interface can be accessed most commonly using the Search Utility, or by typing the IP address (if known) directly into the address field of the Internet Web Browser. This Web interface is designed to serve as the main user interface with the instrument, providing enhancement, configuration, & real-time monitoring functionality. The Website is optimized to work with Microsoft® Explorer 7. Other web browser applications can limit some functionality and/or show an incorrect layout.

In order connect to your G4K Unit & FTP Server you will need to:

- [Obtain Elspec's Search Utility](#)
- [Use the Utility](#)
- [Access either the Unit or FTP Server with the Utility](#)
- [How to look for a New Device](#)
- [Know its Limitations](#)

Obtain Elspec's Search Utility

Elspec Search is a small program which does not require installation and is available free on the Elspec WEB site: www.elspec-ltd.com. You may also copy it by using the [G4K BLACKBOX CD](#) delivered with the G4K Unit. Since the program is small and does not require installation, it is recommended copying it and operating it directly from the computer Desktop.

SEE ALSO

- [About Elspec's Search Utility](#)
- [Use the Elspec's Search Utility](#)
- [G4K Unit Access](#)
- [New Device Indication](#)
- [Limitations of Elspec's Search Utility](#)

Use the Elspec's Search Utility

- After you have [Copied the Utility](#) on your Desktop, access it by clicking on the Elspec's Search Icon:



- Initially, the program may trigger a verification warning similar to the one below. You may proceed by clicking Run:

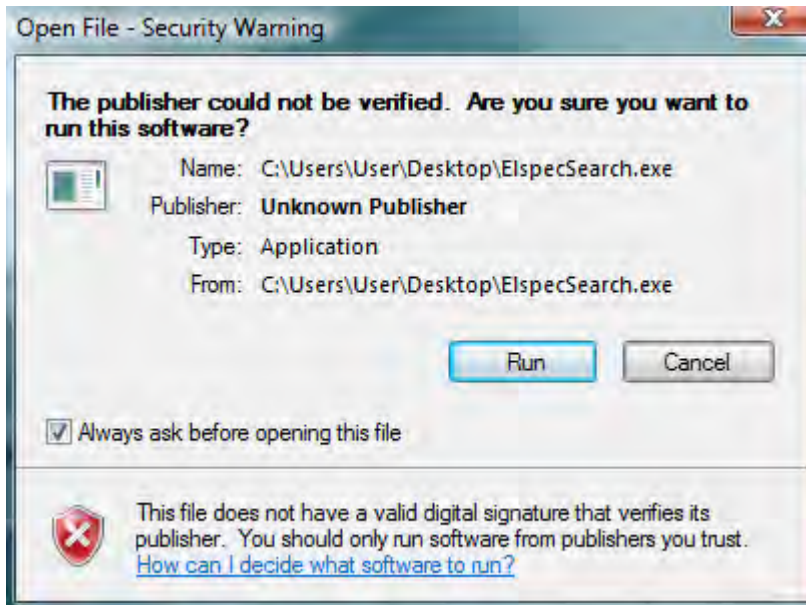

- A scan procedure is initiated; the Elspec Search utility appears as a grid displaying all BLACKBOX devices found on the intranet network:

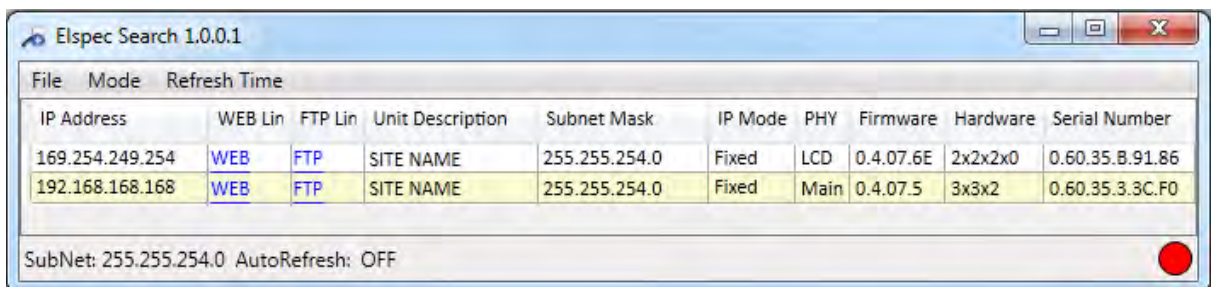

File	Mode	Refresh Time	IP Address	WEB Lin	FTP Lin	Unit Description	Subnet Mask	IP Mode	PHY	Firmware	Hardware	Serial Number
			169.254.249.254	WEB	FTP	SITE NAME	255.255.254.0	Fixed	LCD	0.4.07.6E	2x2x2x0	0.60.35.B.91.86
			192.168.168.168	WEB	FTP	SITE NAME	255.255.254.0	Fixed	Main	0.4.07.5	3x3x2	0.60.35.3.3C.F0

SubNet: 255.255.254.0 AutoRefresh: OFF

- Once open, the scan procedure can be manually prompted by using the File Refresh List Menu:

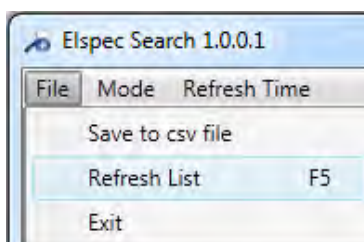

- As an alternative, the scan procedure can be configured to automatically refresh to the Refresh Time. This can be done by setting the Mode **➔** AutoRefresh to ON: (The default state is OFF)



- Set the Refresh Time by selecting Refresh Time **➔** Second:

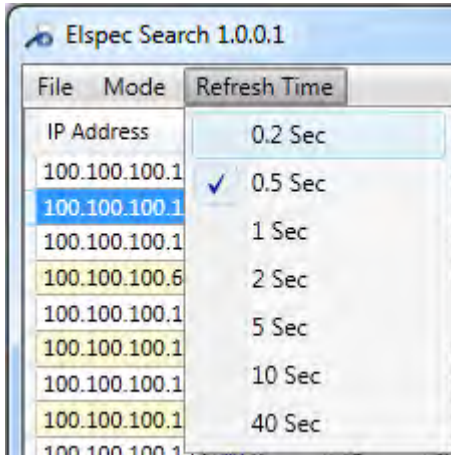

NOTE NOTE NOTE

The Elspec Search list shows a variety of important information about every BLACKBOX device found on network; most of it is helpful to identify devices. It includes the IP Address, Unit Description, SubnetMask, Gateway IP, IP Mode, Firmware Version & the G4K's Serial Number. The most important information being the IP address of each device. This access allows you to [Establish a 1st Time Connection](#).

- By selecting File **➔** Save to csv file will allow you to export all the information appearing in the utility regarding G4K devices in your network for further reference:

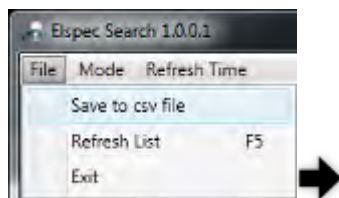

IP Address	Unit Description	Subnet Mask	IP Mode	PHY	Firmware	Hardware	Serial Number
169.254.249.254	SITE NAME	255.255.254.0	Fixed	LCD	0.4.07.6E	2x2x2x0	0.60.35.8.91.86
192.168.168.168	SITE NAME	255.255.254.0	DHCP	Main	0.4.07.5C	3x3x2	0.60.35.3.3C.F0

SEE ALSO

- [About Elspec's Search Utility](#)
- [Obtain Elspec's Search Utility](#)
- [G4K Unit Access](#)
- [New Device Indication](#)
- [Limitations of Elspec's Search Utility](#)

G4K Unit Access

Once you have [Connected the Device for the 1st Time](#), you may access your G4K Unit by simply clicking the WEB Hyperlink button [in your Elspec's Search Utility](#). Alternatively you can simply access the device directly via Internet Explorer by inserting the Device's IP address directly (address is also indicated in [Elspec's Search Utility](#)). The [Utility](#) also provides you with access to your [PQZIP Files](#) via the FTP Server.: Once you have [Connected the Device for the 1st Time](#), you may access your G4K Unit by simply clicking the WEB Hyperlink button in your [Elspec's Search Utility](#). Alternatively you can simply access the device directly via Internet Explorer by inserting the Device's IP address directly (address is also indicated in [Elspec's Search Utility](#). The Default IP Address for a newly supplied G4K unit is: 169.254.249.247.

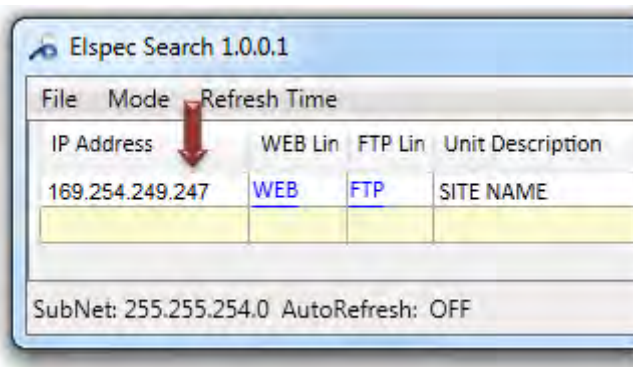

ACCESS INSTRUMENT VIA THE WEB HYPERLINK [RECOMMENDED]

- Select the Web link for your device, Elspec's Web Interface will now open:



- In order to view the different languages in the Web Interface, you will need to upload the language feature from [Elspec's Website](#) when installing your new Firmware. Once uploaded, simply select the applicable interface language from the drop-down list:

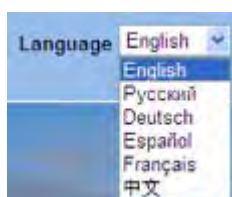

- The supported languages are:
 - English (Default)
 - Russian
 - German
 - Spanish
 - French
 - Chinese
 (For other languages - please contact your local Elspec distributor)
- The Password field defines user level/privileges. The user levels are Viewer / Administrator (See [Security Settings](#)). The default password including privileges for each level are:
 - Viewer is 123 (Read only, can choose interface language only, no operations related changes are allowed)
 - Administrator is 12345 (Administration, setup & full control)

NOTE NOTE NOTE

- The Website is optimized to work with Internet Explorer 7, 8 or 9 in “Compatibility View”. Ensure that the Internet Explorer is running in Compatibility View:



Other web browser applications can limit some functionality and/or show an incorrect layout.

- For local networking the browser should be configured as working without a proxy server. Refer to Disable Proxy Server in Internet Explorer.
- Should you be running Skype simultaneously with [Elspec’s Search](#), you will not be able to access the device via the Web Link. Close Skype & access Elspec’s Search again to follow the [Web Link](#).
- The passwords above are factory default values. You are advised to modify Admin password if extended security measures are required (See [Security Settings](#)).



DIRECT INSTRUMENT ACCESS VIA INTERNET EXPLORER

Access the device by typing the G4K's IP address in the address field in Internet Explorer:

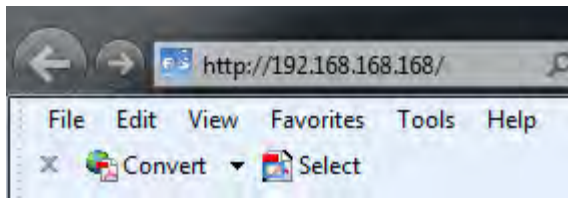

Choose the language & enter the password as outlined above

- Read how to [Identify a New Device](#), about [Elspec's Search Limitations](#)

ACCESS FTP VIA THE FTP HYPERLINK [RECOMMENDED]

The FTP (File Transfer Protocol) link is used for exchanging and manipulating files over a TCP computer network. The BLACKBOX uses an integrated FTP server providing the most convenient computer network standard interface to the generated PQZIP files and auto generated reports. The PQSCADA software system makes use of the FTP server interface by automatically downloading PQZIP files. The same protocol may be used to manually download the PQZIP files.

- Select the FTP link for your device, FTP Server will now open:



FTP root at 192.168.168.168

To view this FTP site in Windows Explorer: press Alt, click View, and then click **Open FTP Site in Windows Explorer**.

01/01/1970 12:00AM Directory [CF](#) [UPMB](#)

- Open Page → Open FTP Site in Windows Explorer. Insert the Username & Password (Either default as above / as per your [Security Settings](#)) → :

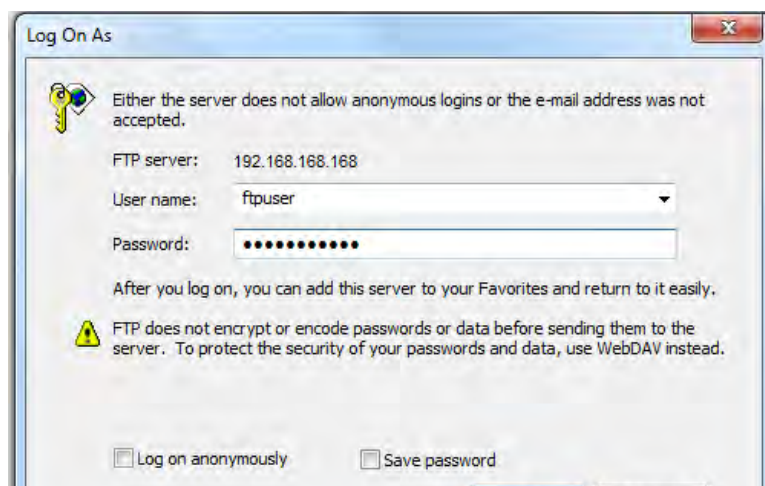

- The FTP server will now open in Windows Explorer containing all the PQZIP files:

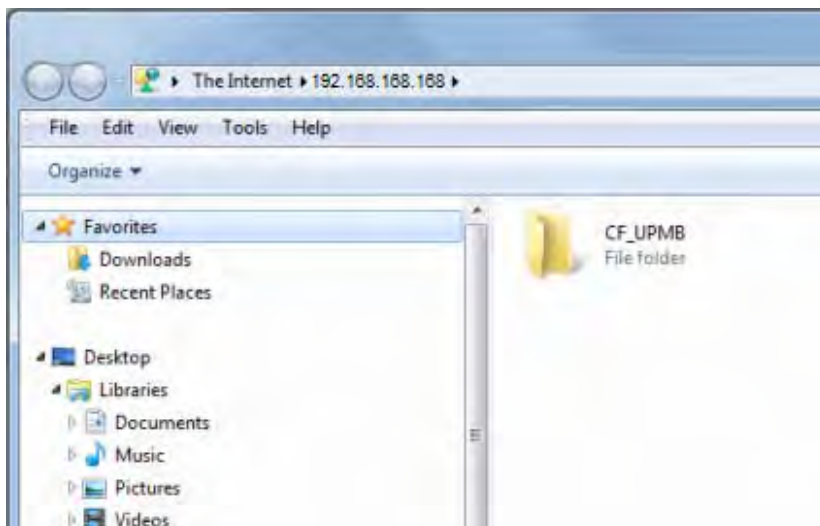

DIRECT FTP ACCESS VIA INTERNET EXPLORER

Access the FTP by typing: ftp://IP address in the address field in the Internet Explorer:

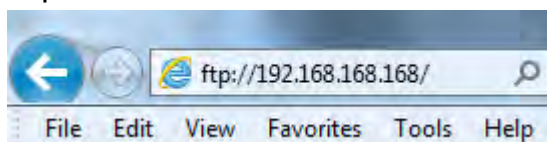

- Enter the password as outlined above.
- Read how to [Identify a New Device](#), about [Elspec's Search Limitations](#).

SEE ALSO

- [About Elspec's Search Utility](#)
- [Obtain Elspec's Search Utility](#)
- [Use the Elspec's Search Utility](#)

New Device Indication

Every new device that wasn't found after the last refresh is marked in green on Elspec's Search Utility:

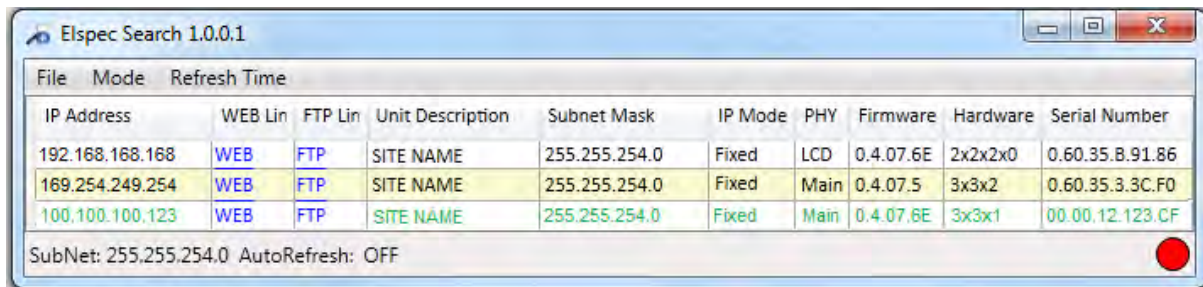

IP Address	WEB Lin	FTP Lin	Unit Description	Subnet Mask	IP Mode	PHY	Firmware	Hardware	Serial Number
192.168.168.168	WEB	FTP	SITE NAME	255.255.254.0	Fixed	LCD	0.4.07.6E	2x2x2x0	0.60.35.8.91.86
169.254.249.254	WEB	FTP	SITE NAME	255.255.254.0	Fixed	Main	0.4.07.5	3x3x2	0.60.35.3.3C.F0
100.100.100.123	WEB	FTP	SITE NAME	255.255.254.0	Fixed	Main	0.4.07.6E	3x3x1	00.00.12.123.CF

SubNet: 255.255.254.0 AutoRefresh: OFF

SEE ALSO

- [About Elspec's Search Utility](#)
- [Obtain Elspec's Search Utility](#)
- [Use the Elspec's Search Utility](#)
- [G4K Unit Access](#)
- [Limitations of Elspec's Search Utility](#)

Limitations of Elspec's Search Utility

Elspec's Search utility can operate only as one single instance at a time, since it uses a single and fixed UDP port. Should you choose to open a new Search Utility window, only the initial Search Utility window will function properly.

When accessing the device via the [Web Link](#) ensure that the Internet Explorer is running in Compatibility View, as some web browser applications can limit the functionality and/or show an incorrect layout:



For local networking, the browser should be configured as working without a proxy server. Refer to Disable Proxy Server in Internet Explorer.

Should you be running Skype simultaneously with [Elspec's Search](#), you will not be able to access the device via the Web Link. Close Skype & access Elspec's Search again to follow the [Web Link](#).

SEE ALSO

- [About Elspec's Search Utility](#)
- [Obtain Elspec's Search Utility](#)
- [Use the Elspec's Search Utility](#)
- [G4K Unit Access](#)
- [New Device Indication](#)

G4K Specifications

This section includes common specifications for the G4K:

INPUT CHARACTERISTICS:

VOLTAGE INPUTS	G4410	G4420	G4430
Number of Inputs	AC: 4 (3 Phase & Neutral)	AC: 4 (3 Phase & Neutral)	AC: 4 (3 Phase & Neutral)
Maximum Input Voltage (V_{RMS})	1KV	1KV	1KV
Nominal Voltage Range (V_{RMS})	110 to 690V	110 to 690V	110 to 690V
Maximum Peak Measurement Voltage (V_{PK})	8kV	8kV	8kV
Input Impedance	3M Ω	3M Ω	3M Ω
Bandwidth	6.25kHz	12.5kHz	25kHz
Nominal Frequency	42.5 to 69Hz	42.5 to 69Hz	42.5 to 69Hz
CURRENT INPUTS	G4410	G4420	G4430
Number of Inputs	AC: 4 (3 Phase & Neutral)	AC: 4 (3 Phase & Neutral)	AC: 4 (3 Phase & Neutral)
Nominal Full Scale (I_{RMS})	5A	5A	5A
Maximum Peak Measurement (I_{PK})	50A	50A	50A
Range	0 to 50A	0 to 50A	0 to 50A
Burden	0.1mVA @ 5A	0.1mVA @ 5A	0.1mVA @ 5A
Bandwidth	6.25kHz	6.25kHz	6.25kHz
SAMPLING SYSTEM	G4410	G4420	G4430
Maximum Sampling Rate for Each Channel Simultaneously:			
Voltage	256 Samples/Cycle	512 Samples/Cycle	1024/512 Samples/Cycle
Current	256 Samples/Cycle	256 Samples/Cycle	256/512 Samples/Cycle
Type of Analog to Digital Converter	16/20 ¹ Bit	16/20 ¹ Bit	16/20 ¹ Bit
Resolution	Dual Range Gain of 2 x 16 Bit on 8 Channels		
PLL Synchronization	1024 Samples on 10/12 Cycles According IEC61000-4-7		

¹ Effective Bit

MEASUREMENT RANGE, RESOLUTION, ACCURACY:

VOLT/AMPS/HERTZ	MEASUREMENT RANGE	RESOLUTION	ACCURACY
V _{RMS} (AC & DC)	0 to 900V	0.01V	±0.1% of Nominal Voltage ¹
A _{RMS}	1 to 5A	0.1mA	±0.1% of Nominal Current
V _{Pk}	8KV	10mV	±0.1% from Reading
Voltage Crest Factor	1<	0.01	Better than 0.5%
Current Crest Factor	1<	0.01	Better than 0.5%
Hz to 50Hz Nominal	42.5 to 62Hz	10mHz	±5mHz
Hz to 60Hz Nominal	51 to 69Hz	10mHz	±5mHz
K-Factor	0<	0.01	±0.25%
DIPS, SWELLS & INTERRUPTIONS	MEASUREMENT RANGE	RESOLUTION	ACCURACY
V _{RMS} ^{1/2} (AC & DC)	0 to 900V	0.01V	±0.2% of Nominal Voltage
Duration	HHH,MM,SS,MMM	Half Cycle	One Cycle
Threshold Levels	Programmable Thresholds & Hysteresis in Percentage of Nominal Voltage Event Detection Based Upon 1/2 Cycle RMS Voltages Captures Dips, Swells, Interruptions & Rapid Voltage Changes		
VOLTAGE HARMONICS	MEASUREMENT RANGE	RESOLUTION	ACCURACY
Harmonic Order	1 to 50 Grouping: Harmonic Subgroups According to IEC61000-4-7		
Inter-Harmonic Order	1 to 50 Grouping: Inter-Harmonic Subgroups According to IEC61000-4-7		
THD _(n=50)	0 to 100%	0.01%	±0.25%
THD Even	0 to 100%	0.01%	±0.25%
THD Odd	0 to 100%	0.01%	±0.25%
Hz (Spectrum)	0 to 3174Hz	fSys 10/12	±5%
Phase Angle	-180 to +180°	0.01°	±0.01°

¹ For Nominal Voltage 80 to 690V

POWER & ENERGY	MEASUREMENT RANGE	RESOLUTION	ACCURACY
Active Power	$\pm 5\text{kW} \times \text{CT Ratio} \times \text{PT Ratio}$	10mW	$\pm 0.2\%$
Reactive Power	$\pm 5\text{kVAR} \times \text{CT Ratio} \times \text{PT Ratio}$	10mVAR	$\pm 2\%$
Apparent Power	$\pm 5\text{kVA} \times \text{CT Ratio} \times \text{PT Ratio}$	10mVA	$\pm 0.2\%$
Active Energy	$\pm 5\text{kWh} \times \text{CT Ratio} \times \text{PT Ratio}$	10mWh	$\pm 0.2\%$
Reactive Energy	$\pm 5\text{kVARh} \times \text{CT Ratio} \times \text{PT Ratio}$	10mVARh	$\pm 2\%$
Apparent Energy	$\pm 5\text{kVAh} \times \text{CT Ratio} \times \text{PT Ratio}$	10mVAh	$\pm 0.2\%$
True Power Factor	± 1 (CAP\IND)	10 μ	$\pm 0.2\%$
Displacement Power Factor	± 1 (CAP\IND)	10 μ	$\pm 0.2\%$
FLICKERING	MEASUREMENT RANGE	RESOLUTION	ACCURACY
P_{SST} , P_{ST} 10 Minutes, S_{PLT} , P_{LT} 2 Hours, L_{PLT}	0 to 20	0.01	$\pm 5\%$
PST_{INST}	0 to 20	0.01	$\pm 8\%$
UNBALANCE	MEASUREMENT RANGE	RESOLUTION	ACCURACY
Volts (Negative & Zero Seq.) Ratio	0 to 100%	0.1%	0.15%
Current (Negative & Zero Seq.) Ratio	0 to 100%	0.1%	0.5%
TRANSIENT CAPTURE			ACCURACY
Minimum Detection Duration			78.1 μs (G4410) 39 μs (G4420) 19.5 μs (G4430)

GENERAL SPECIFICATIONS:

STORAGE CAPACITY			
	G4410	G4420	G4430
Internal Memory	128MB	4GB	16GB
REAL-TIME (SELF SYNCHRONIZATION)			
Real Time Clock	± 1 Second per 24 Hours		
Time Synchronization	Optional GPS/SNTP/IRIGB/DCF-77 time sync module provides time uncertainty better than 100µs. When synchronization becomes unavailable, Time Tolerance is 1 second per day.		
DEVICE SYNCHRONIZATION ACCURACY			
GPS & PPS	Better than 100µs		
IRIG B ¹	100 to 200µs		
DCF-77	±15ms		
SNTP Server	50 to 100µs		
COMMUNICATION			
CONTROL			
Web Server	Comprehensive web server for local & remote real-time monitoring & control		
FTP Server	Standard protocol for main storage memory		
PORTS			
	G4410	G4420	G4430
Ethernet Ports	1	2	2
RS485/422	1	1	1
LAN 1			
Baud Rate	10/100MBit		
Communication Protocols	Modbus TCP, OPC, DNP3, TELNET & SMTP Client		
Connector Type	RJ45 Female With Led Indicators		
Power Over Ethernet (PoE- In)	1 (Available as Input - 13 Watt, DC: 48V)		
LAN 2			
Baud Rate	10/100MBit		
Communication Protocols	Modbus TCP, OPC, DNP3, TELNET & SMTP Client		
Connector Type	RJ45 Female With Led Indicators		
Power Over Ethernet (PoE- Out)	1 (Available as Output - 13 Watt, DC: 48V)		
RS485/422 CONNECTION			
Baud Rate	Configurable: 1200 / 2400 / 4800 / 9600 / 14400 / 19200 / 38400 57600 / 115200		
Communication Protocols	Modbus RTU, PPP & TTY		
Duplex	Full		
Maximum Cable Length	15.2m (50')		

APPLICABLE STANDARDS

Measurement Standards	EN50160, IEEE1159, IEEE519, IEC61000-4-15, IEC61000-4-7, IEC61000-4-30 Class A, IEC62053-22/23 Class 0.2
EMC Standards	EN55011 Group 1 Class A, EN60439-1 (Clauses 7.9.1, 7.9.3, 7.9.4, 7.10.3, 7.10.4), FCC Part 15 Subpart B Class A, IEC61000-3-3, EN61000-6-2, IEC60255
Environmental Standards	IEC60068-2-1, 2, 6, 11, 27, 30, 75
Safety Standards	EN61010-1:2001 2 ND Edition

POWER SUPPLY

Power Over Ethernet (PoE- In) ²	According to 802.3af
Operating Range	AC: 100 to 260V @ 50/60Hz DC: 100 to 300V
Auxiliary AC Supply	DC: 48V
Low Voltage Ride Through	Up to 25 Seconds

¹ Only if Multi IO Module is present

² G4420 & G4430 Units Only

POZIP RECORDING:

METHOD

PQZIP compression technology which enables continuous gap-less¹ recording of all electrical parameters-related data for a significant time duration without the need of event thresholds of any kind. Events, Flicker and Energy are non-compressed parameters.

WAVEFORM	G4410	G4420	G4430
Voltage Sampling per Cycle	256	512	1024/512
Current Sampling per Cycle	256	256	256/512
Recording Time	1 Day Continuous Recording at a Fixed Ratio Mode of 3GB/Month	3 Months Continuous Recording at a Fixed Ratio Mode of 1.2GB/Month	1 & Year Continuous Recording at a Fixed Ratio Mode of 1.2GB/Month

EVENTS

Memory Up to 12K Event Logs

FLICKER PST	G4410	G4420	G4430
Recording Interval	10 Minutes	10 Minutes	10 Minutes
Recording Time	1 Day Continuous Recording at a Fixed Ratio Mode of 3GB/Month	3 Months Continuous Recording at a Fixed Ratio Mode of 1.2GB/Month	1 & Year Continuous Recording at a Fixed Ratio Mode of 1.2GB/Month

ENERGY	G4410	G4420	G4430
Energy Interval	1, 2, 5, 10, 15, 30 & 60 Minutes	1, 2, 5, 10, 15, 30 & 60 Minutes	1, 2, 5, 10, 15, 30 & 60 Minutes
Recording Time	1 Day Continuous Recording at a Fixed Ratio Mode of 3GB/Month	3 Months Continuous Recording at a Fixed Ratio Mode of 1.2GB/Month	1 & Year Continuous Recording at a Fixed Ratio Mode of 1.2GB/Month

¹ 99.9% of the Time

SEE ALSO:

- [G4K Physical Specifications](#)

G4K Physical Specifications

This section includes the Physical specifications for the G4K without the Multi IO, including:

PHYSICAL SPECIFICATIONS:

PHYSICAL	
Dimensions	175mm x 232mm x137.5mm (6.88" x 9.13" x 5.41")
Weight	1.7Kg (3.74Lb)
ENVIRONMENTAL	
Design	Sleek black, shock proof, easy install, with Multi IO extension option
Drip and Dust Proof	IP20 according to IEC60529 when used in tilt stand position
Shock and Vibration	Shock 30g, Vibration: 3g Sinusoid, Random 0.03 g2/Hz according to MIL-PRF-28800F Class 2
Operating Temperature	-20 to 70 °C (-4 to 158 °F)
Storage Temperature	-40 to 85 °C (-40 to 185 °F)
Humidity	85%
Maximum Operating Altitude	2Km (1.24Mi)
Warranty	One Year
TEMPERATURE SENSORS	
External Temperature Sensor (PT100)	-40 to 90 °C (-40 to 210 °F)
Internal PSU Temperature Sensor	Informative
Internal DSP Temperature Sensor	Informative

DIMENSIONS:

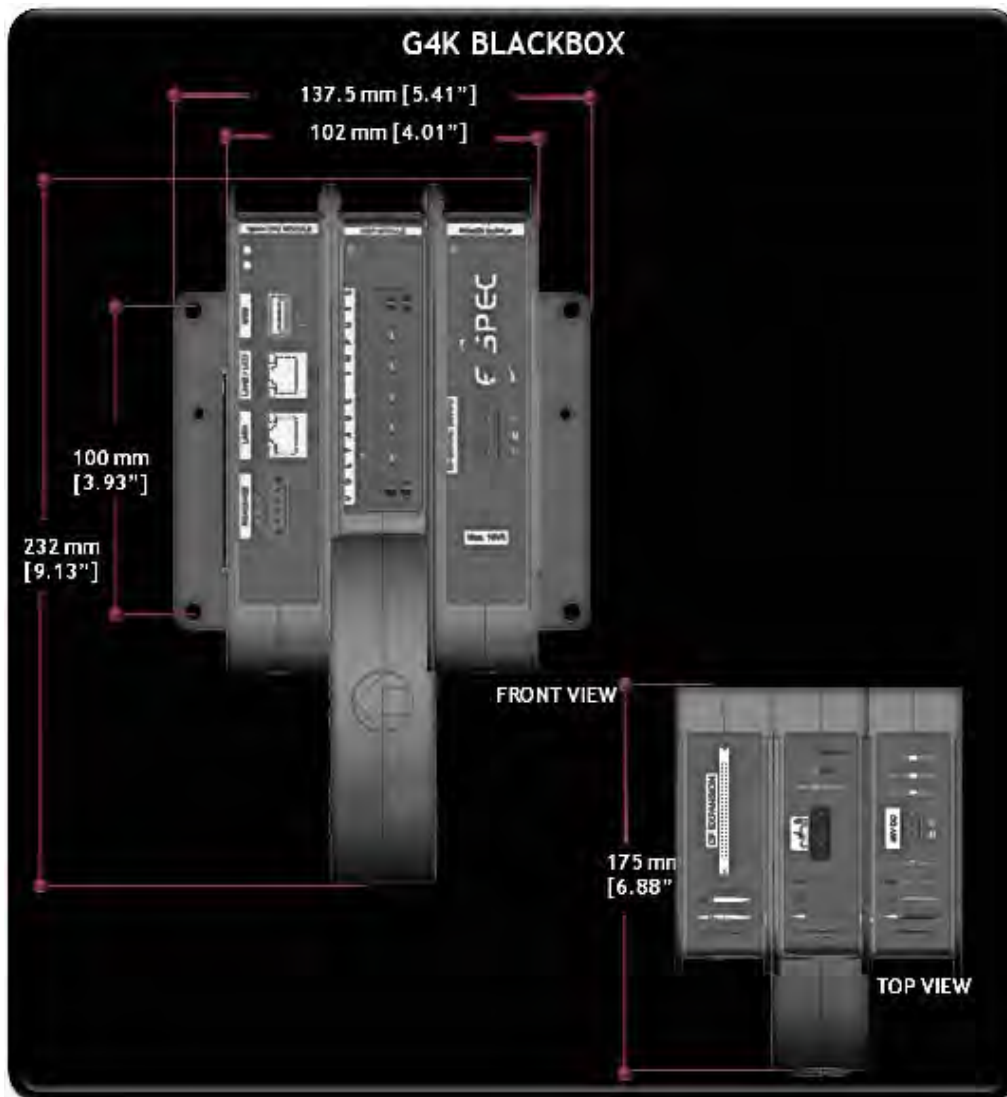

SEE ALSO:

- [G4K Specifications](#)