



THV



General Description

Single phase power controller has an LED display to show set values and input signals and front keys for easy setting and monitoring. Loaded with versatile standard functions, the THV operates at 100 up to 240V AC and automatically selects power supply frequency 50 or 60Hz.

Standards Functions

- ☆ Control type selection (Phase-angle/continuous zero-cross/zero-cross)
- ☆ Ramp-up, Ramp-down
- ☆ Manual output
- ☆ Gradient setting
- ☆ Output Limiter High and Low
- ☆ Base-up Setting (output bias)
- ☆ Output mode selection (proportional electric power/voltage/phase angle)
- ☆ Digital input for Auto/manual
- ☆ Analog input for manual output setting
- ☆ Analog input for Gradient setting

Three Types of Control Mode (Selectable)

● Phase control

The waveform of the load power is switched at a desired phase angle q to provide smooth control.



● Zero-cross control (Continuous proportion)

Power is switched on and off when the supply voltage is at 0V. This system suppresses high frequency noise inherent to phase control.



● Zero-cross control (Input synchronization system)

Supply voltage is switched on and off according to the voltage pulse and contact signals from a controller.

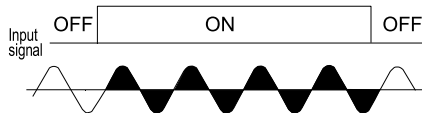

Gradient Setting

The relation between the setting input and the output voltage can be set. Gradient setting is possible via front keys or an external setter. Control characteristics may vary with the setting as follows.

1. Auto setting input X Internal gradient setting X External gradient setting
2. Auto setting input X Internal gradient setting
3. Manual setting X Internal gradient setting X External gradient setting

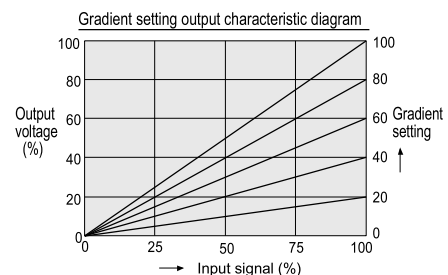

Ramp function (Soft-start & Soft-down)

Even if setting input changes abruptly, output changes slowly to suppress inrush current. Ramp-up (Start-up) and ramp down (Start-Down) time can be set in the range of 0.1 to 99.9 sec via front keys.

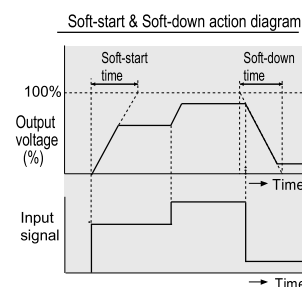

Standards Functions

Output limiter (High & Low)

Output highest and lowest values can be set via front keys.

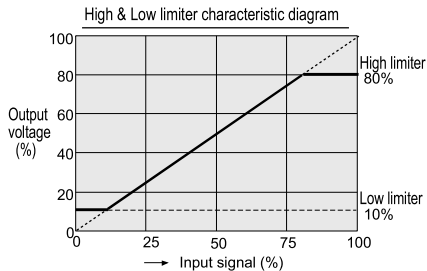

Base-up setting (Output bias)

Output when the setting input is zero can be set via front keys. (Base-up setting is valid when output limiter low is set to 0.0)

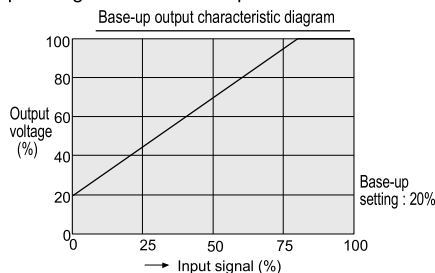

3 type of output modes

When phase control is selected for linear load (R: resistor), output mode can be selected from Proportional phase angle to input, proportional voltage to input, and proportional square voltage (electric power) to input.

* Default setting is proportional square voltage to input.

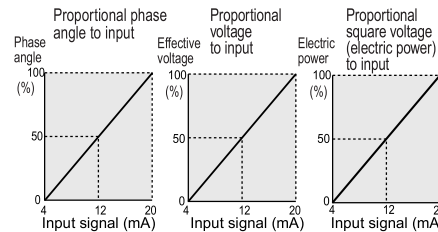

Optional Functions

- ☆ Heater break alarm
- ☆ Output voltmeter (Only phase control)
- ☆ Current limiter (Only phase control)

This is a function to control not to exceed the current limiter value which load current set. Because it is not held down rush current in the case of the load that rush current is big, please use it together with a soft start function.

Specifications

Maximum Load Current

20A AC, 30A AC, 45A AC, 60A AC, 80A AC, 100A AC

Control Method

Phase control, Zero-cross control (Selectable)

Applicable Load

Linearity (R:Resistor) load
 Inductive load (When phase control: Control of primary side of a transformer, magnetic field density 1.25T or less)

Input Signal

- a) Current input 4 to 20mA DC (Input impedance : 100 Ω)
- b) Voltage input 1 to 5V DC (Input impedance : 30kΩ)
- c) Voltage pulse input 0/12V DC (Input impedance : 30kΩ)
- d) Non-voltage contact input (Input impedance : 47Ω)

Minimum Load Current

0.6A (20A type), 1A (30A, 45A, 60A, 80A, 100A type)

Output Voltage Range

0 to 98% of rated voltage

Power Supply Voltage

90 to 264V AC (Including power supply voltage variation)
 [Rating : 100 to 240V DC]

Power Frequency

50/60Hz (Automatic discriminating)

Allowable Power Frequency Variation

±1Hz (Performance guarantee range)
 ±2Hz (Operating guarantee range)

Output Setting Range

Gradient setting : 0.0 to 100% [Front key or external setting unit]
 Output limiter (High) : 0.0 to 99.9% [Front key or external setting unit]
 Output limiter (Low) : 0.0 to 99.9% [Front key or external setting unit]
 Base-up setting (Output bias) : 0.0 to 99.9% [Front key]
 Manual setting : 0.0 to 99.9% [Front key]

Output Mode

When phase control is selected for linearity load (R: resistor), output mode can be selected from Proportional phase angle to input, proportional voltage to input, and proportional square voltage (electric power) to input.

Current Limiter (Optional : Only phase control type)

Setting Range : 0 to 32A (20A, 30A type)
 0 to 55A (45A type)
 0 to 70A (60A type)
 0 to 90A (80A type)
 0 to 110A (100A type)

Heater Break Alarm (Optional)

Accuracy : Less than ±2A (20A, 30A)
 Less than ±10% of rated current (45A, 60A, 80A, 100A)
 Alarm decision delay frequency : 0 to 99
 Output : Open collector output, 24V DC, Maximum 100mA

Cooling Method

Natural convection

Allowable Ambient Temperature

Performance guarantee range: 0 to +40°C
 Operating guarantee range: -15 to +55°C

Allowable Ambient Humidity

5 to 95%RH (Non-condensing)

Dielectric Voltage

Between main circuit, power terminals and radiation fins
 : 2000V AC for one minute.

Insulation Resistance

Between main circuit, power terminals and radiation fins
 : 20M ohms or more (500V DC)

Mounting Method

Vertical mounting

Weight

Approx. 0.9kg (20A, 30A)
 Approx. 1.3kg (45A, 60A)
 Approx. 1.9kg (80A, 100A)

Contents of Digital Display

Input signal value, Phase angle ratio value, Frequency value, Control method, Soft up/Soft down time, Gradient set value, Output limiter (High/Low), Base-up set value,

Compliance with Standards

- UL Recognized
- CSA Certified (Released soon)



- Temperature characteristics of load current

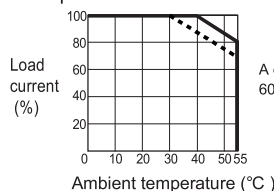

A dotted line means the case of 60A type side cohesion mounting.

Power Controller THV Series

External Wiring

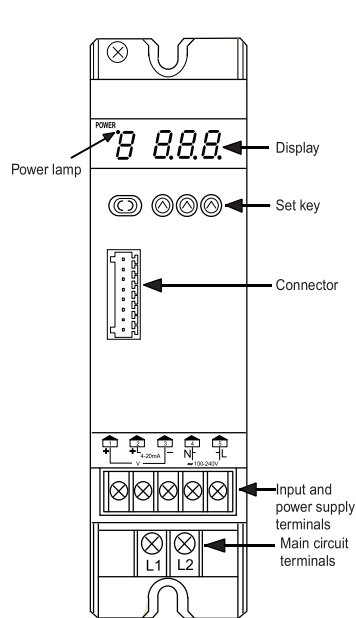

Main circuit

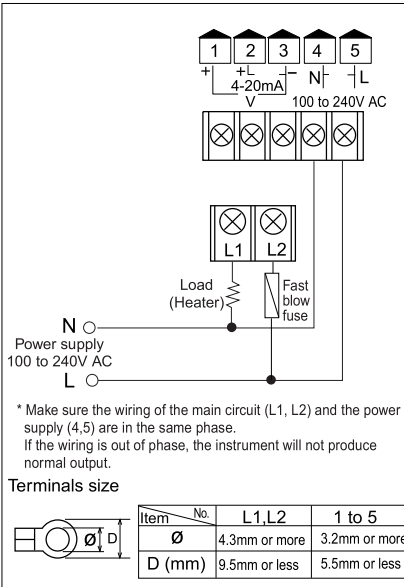

Input signal

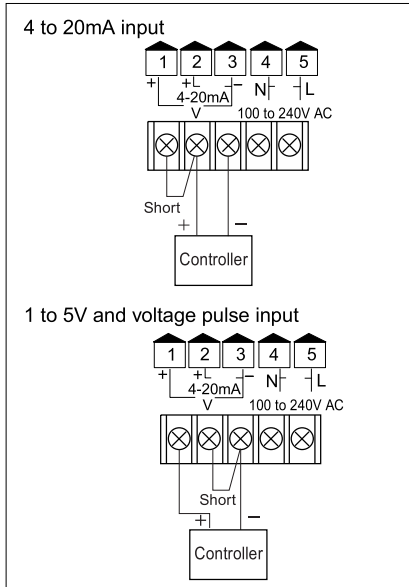

Connector

Pin No.	Contents
1	+5V output
2	0V (GND)
3	Gradient setting input (0 to 5V input by gradient setter)
4	Manual setting input (0 to 5V input by manual setter)
5	Auto/manual setting selection (Open:Auto setting) • External contact input Shorting pins No.2 (GND) with No.5 pin results in the manual setting mode.
6	Open collector output (+) : Heater break alarm output
7	Open collector output (-) : Heater break alarm output
8	Unused

Contact input

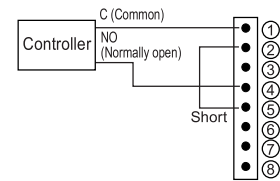

• Auto setting (With gradient setter)

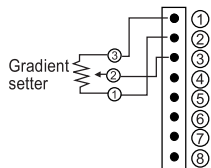

• Manual setting (With manual setter)

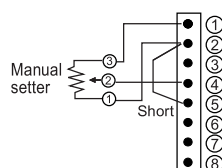

• Auto/Manual setting selection

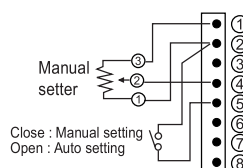

• Auto/Manual setting selection (With gradient setter)

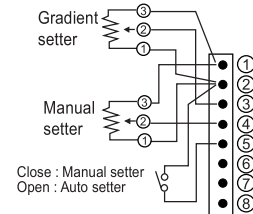

• ON/OFF control

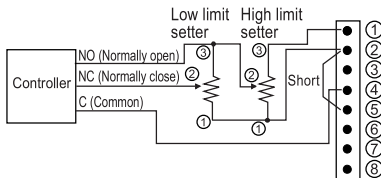

• Heater break alarm output

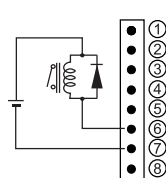

* Connect a diode when a relay is used.

Output setting selection

There are three output settings; input signal from a controller, external manual setting, and internal manual setting. Selection can be made via front keys for external contact action selection and external contact (connector Nos. 2-5).

External contact action selection	External contact	
	Close	Open
Only internal manual setting (Front key)	Internal manual setting	Internal manual setting
Internal manual setting (Front key) / Input signal	Internal manual setting	Input signal from controller
External manual setting (Front key) / Input signal	External manual setting	Input signal from controller

* External contact is open when a connector is not used.