



A trusted leader in measurement  
and calibration solutions.

# User Manual

## M2000/M2000X Smart Manometer

*Smart Manometer and Sensors*

*Meriam Tethered Sensors*

*meriSuite CG Application*



CE

© Western / Scott Fetzer Co. 2020

Find Quality Products Online at:

[www.GlobalTestSupply.com](http://www.GlobalTestSupply.com)

[sales@GlobalTestSupply.com](mailto:sales@GlobalTestSupply.com)

# Contents

<b>General Information</b> .....	4
Notification statements .....	4
Glossary .....	5
<b>General warnings and cautions</b> .....	7
Preventing injury .....	7
Safety symbols.....	7
Sample label for General Purpose Smart Manometers .....	8
Fire or explosion hazard.....	8
For General Purpose series .....	8
For Intrinsically Safe series .....	9
Do not exceed pressure limits .....	12
<b>Sensors</b> .....	13
Meriam Tethered Sensors (MTS).....	15
How to zero Absolute sensors.....	15
How to zero Differential or Compound sensors .....	17
<b>Smart Manometer</b> .....	18
Battery and USB power.....	18
Batteries.....	18
The display .....	20
Keypad: Description of the keys .....	21
The backlight.....	23
Measurement units.....	24
Damping .....	25
Data Logging.....	26
Leak Test .....	27
Relief Valve Test .....	30
Differential displays.....	31
Auto Off (Automatic shut off).....	31
What does the Zero (∅) key do? .....	32
<b>meriSuite CG application</b> .....	33
How does meriSuite CG benefit you?.....	33
meriSuite CG and USB Drivers required.....	33
Tips for using meriSuite CG .....	34
Connection status.....	37
Configuration button .....	39
User Calibration button .....	43
Data Log button .....	45
TSV file format.....	47
Application button.....	58
Update button.....	59
<b>Specifications</b> .....	60
Internal sensors: type and range.....	60
Internal sensors: type and range - continued.....	61

Meriam Tethered Sensors: type and range.....	62
Pressure measurements .....	63
Resistance and temperature measurement capabilities.....	63
Overrange limit.....	64
Temperature.....	64
Relative humidity.....	64
Vibration .....	64
Ingress specifications .....	64
Altitude specifications.....	64
Keypad.....	64
Media compatibility.....	65
Battery type.....	65
EMC compliance.....	70
Dimensional specifications.....	71
Weight.....	72
Enclosure .....	72
<b>Maintenance and cleaning</b> .....	77
Cleaning.....	77
Prepare the Smart Manometer for storage.....	77
<b>Help</b> .....	78
Register your product.....	78
Find downloads and documents .....	78
<b>Western Contact Information</b> .....	79
Repair or Calibration.....	80

# General Information

## *Notification statements*

### Disclaimer

Every precaution has been taken in the preparation of this manual. Nevertheless, Meriam assumes no responsibility for errors or omissions or any damages resulting from the use of the information contained in this publication, including, without limitation, incidental, special, direct or consequential damages. MERIAM MAKES NO REPRESENTATIONS OR WARRANTIES WITH RESPECT TO THE ACCURACY OR COMPLETENESS OF THE CONTENTS HEREOF AND SPECIFICALLY DISCLAIMS ANY IMPLIED WARRANTIES OF MERCHANTABILITY OR FITNESS FOR ANY PARTICULAR PURPOSE. Meriam reserves the right to revise this publication and to make changes from time to time in the content hereof without obligation to notify any person of such revision or changes.

In no event shall Meriam be liable for any indirect, special, incidental, consequential, or punitive damages or for any lost profits arising out of or relating to any services provided by Meriam or its affiliates.

It is not possible for Meriam to identify all foreseeable uses or misuses, therefore all persons involved in commissioning, using, or maintaining this product must satisfy their self that each intended application is acceptable.

### Copyright

This publication is proprietary to Meriam and no ownership rights are transferred. Neither this manual, nor any of the material contained herein, may be reproduced without the prior written consent of Meriam.

### Trademark information

Design Patent D769,141 for the Smart Manometer's LCD display.

All other trademarks are the property of their respective owners.

## Glossary

Words and phrases with their definitions or explanations.

<b>Words &amp; phrases</b>	<b>Definitions or explanations</b>
<b>Blinking</b>	<ul style="list-style-type: none"> <li>It indicates the active edit field on an edit screen.</li> <li>It indicates the displayed value is not actively changing (like <b>Hold</b> or stopped <b>Test</b>).</li> </ul>
<b>FS</b>	<ul style="list-style-type: none"> <li>FS is the abbreviation of Full Scale.</li> </ul>
<b>Home</b>	<ul style="list-style-type: none"> <li>Home is the first screen that displays after turning on the Smart Manometer. It's the screen with <b>measurements and units</b> on it.</li> <li>After you press the Home key in many other screens, the Smart Manometer returns you to Home.</li> </ul>
<b>Key and button</b>	<ul style="list-style-type: none"> <li>A <i>key</i> refers to hardware push-buttons on the keypad that you can press.</li> <li>A <i>button</i> refers to an area in meriSuite CG that you can tap or click to select functions.</li> </ul>
<b>Isolated</b>	<ul style="list-style-type: none"> <li>The word <i>isolated</i> refers to the sensing element being separated from the media. It is commonly used in the phrases Absolute Isolated (AI) pressure and Compound Isolated (CI) pressure.</li> </ul>
<b>Customer Calibration</b>	<ul style="list-style-type: none"> <li>Customer calibration refers to any calibration done outside of Meriam with non-Meriam traceability.</li> <li>Customer calibration includes: Multipoint calibration or adjustment.</li> </ul>
<b>Meriam Tethered Sensor (MTS)</b>	<ul style="list-style-type: none"> <li>A Meriam Tethered Sensor (MTS) always refers to an external pressure sensor P2 or to an external temperature sensor T2.</li> </ul>
-- P1 --	<ul style="list-style-type: none"> <li>P1 on the display always refers to the internal sensor.</li> </ul>
-- P2 -- or -- T2 --	<ul style="list-style-type: none"> <li>P2 on the display always refers to the external pressure sensor.</li> <li>T2 on the Smart Manometer display always refers to the MTS RTD temperature sensor.</li> </ul>
P   P2	<ul style="list-style-type: none"> <li>Data from the internal and external pressure sensors display in two lines on the Smart Manometer at the same time.</li> </ul>
P   T2	<ul style="list-style-type: none"> <li>Data from the internal pressure sensor and MTS temperature RTD sensor display on the Smart Manometer at the same time.</li> </ul>

<b>Words &amp; phrases</b>	<b>Definitions or explanations</b>
DIFF P1 P2	<ul style="list-style-type: none"> <li>The displayed result of the external pressure measurement subtracted from the internal pressure measurement.</li> </ul>
DIFF P2 P1	<ul style="list-style-type: none"> <li>The displayed result of the internal pressure measurement subtracted from the external pressure measurement.</li> </ul>
- - out -	<ul style="list-style-type: none"> <li>out displays on the process readout when the information readout is providing information about exiting tests.</li> </ul>

# General warnings and cautions

## Preventing injury





Failure to follow all instructions could result in injury:

- Read the entire manual before using the Smart Manometer.
- Understand the contents before using the Smart Manometer.
- Follow all safety warnings and instructions provided with this product.

## Safety symbols

The following table defines the safety symbols, signal words, and corresponding safety messages used in the manual. These symbols:

- Identify potential hazards.
- Warn you about hazards that could result in personal injury or equipment damage.

Safety symbols	Explaining the symbols
	This is the <i>Read directions before using</i> symbol. This symbol indicates that you must read the instruction manual.
	Indicates a potentially hazardous situation which, if not avoided, will result in death or serious injury.
	Indicates a potentially hazardous situation which, if not avoided, could result in death or serious injury.
	Indicates a potentially hazardous situation which, if not avoided, could result in minor or moderate injury.
	Indicates information essential for proper product installation, operation or maintenance.

## Sample label for General Purpose Smart Manometers

All M2000 Series models are available for general-purpose use.

General Purpose (GP) versions are identified by the name plate located on the rear of the unit under the protective rubber boot. A sample of the General Purpose name plate is shown below:

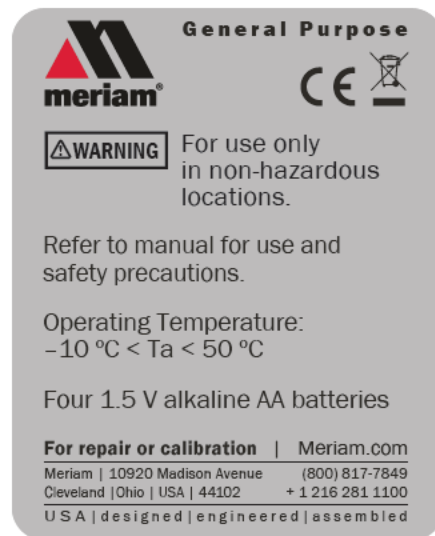

### Fire or explosion hazard

#### **⚠ DANGER**

- **Do not** use General Purpose versions in hazardous areas.
- **Do not** use General Purpose versions in areas that may contain flammable gas or vapors, combustible dusts or ignitable fibers where an unintended spark can cause a fire or explosion.

### For General Purpose series

#### **⚠ CAUTION**

Substitution of components may impair operation and safety.

- Disconnect power before servicing.
- Do not power the Smart Manometer with a combination of new and old batteries.
- Do not power the Smart Manometer with a combination of batteries from different manufacturers.



# Sample label for Intrinsically Safe Smart Manometers

## Intrinsically Safe—M2000X Marking



Intrinsically Safe versions are identified by the nameplate located on the battery door. A sample of the Intrinsically Safe nameplate is shown below:



## Intrinsically Safe gauges



### M2000X Smart Manometer

Directives for the proper use of equipment are located on [9R698-Intrinsically Safe Control Drawing](#) that accompanies each M2000X shipped.

- Component substitution may impair Intrinsic Safety.
- Repairs must be made at Meriam to retain the Intrinsic Safety Certification.
- Service gauges only in a safe location.
- Replace batteries only in a safe location.

## Sample label for Intrinsically Safe Tethered Sensors

### Intrinsically Safe—MTSX Marking

See the figure of a sample label below.

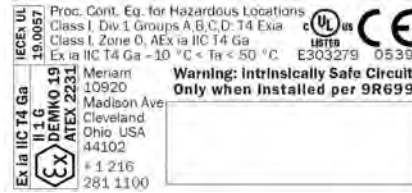

### Intrinsically Safe tethered sensors





#### MTSX Meriam Tethered Sensors

Directives for the proper use of equipment are located on [9R699-Intrinsically Safe Control Drawing](#) that accompanies each MTSX shipped.



- Component substitution may impair Intrinsic Safety.
- Repairs must be made at Meriam to retain the Intrinsic Safety Certification.
- Service sensors only in a safe location.

## Approvals

### M2000X Intrinsically Safe Model

<b>ATEX</b>	 II 1 G; Ex ia IIC T4 Ga DEMKO 19 ATEX 2196
<b>IECEX</b>	Ex ia IIC T4 Ga -10° C < Ta < +50° C IECEX UL 19.0026
<b>cULus Listed</b>	Intrinsically Safe  Class I, Div. 1 Groups A, B, C, D: T4 Exia Class I, Zone 0, AEx ia IIC T4 -10° C < Ta < +50° C
<b>Entity parameters:</b>	Po = 1.176W, Io = 227mA, Co = 19.99µF, Lo=0 µH, Uo = 5VDC Um=6VDC  CE Compliance

### MTSX Intrinsically Safe model

<b>ATEX</b>	 II 1 G; Ex ia IIC T4 Ga DEMKO 19 ATEX 2231
<b>IECEX</b>	Ex ia IIC T4 Ga -10° C < Ta < +50° C IECEX UL 19.0057
<b>cULus Listed</b>	Intrinsically Safe  Class I, Div. 1 Groups A, B, C, D: T4 Exia Class I, Zone 0, AEx ia IIC T4 Ga -10° C < Ta < +50° C
<b>Entity parameters:</b>	Pi = 1.25W, Ii = 227mA, Ci = 20 µF, Li=0 µH, Ui = 5VDC  CE Compliance

### M2000 and MTS (General Purpose models)

 CE Compliance Safety

## *Do not exceed pressure limits*

 **WARNING**

- **Do not** exceed the Pressure Limits listed in the Specifications section of this manual.
- Failure to operate within the specified pressure limit could result in minor or moderate injury.

# Sensors

## Overview of sensors

The Smart Manometer can display two measurements: one from the internal sensor and one from the optional tether sensor.

### NOTICE

- P1 on this Smart Manometer always refers to the internal sensor.
- P2 or T2 on this Smart Manometer always refers to the external sensor.

## Use two wrenches to install or remove pressure connections

Connection: 1/8" female NPT, 316L SS.

- Always use a 3/4 in. wrench on the pressure manifold when you install or remove the 1/8 in. NPT fitting.
- Applying torque to the manifold can damage the plastic enclosure and voids the warranty.
- Do not over tighten.

## Carefully equalize the pressure

Avoid these two issues with **differential sensors**:

1. Connecting pressure to the incorrect pressure port on DN or DI differential pressure modules may cause damage to the pressure sensor.
2. Applying pressure to either port before both connections are made.

### NOTICE

Apply pressure to both differential ports at the same time.

*Note: See Overrange limit in the section called Specifications concerning overrange pressure limits. If over pressure damage occurs, you must return the Smart Manometer to the factory for sensor replacement.*

### Sensor manifold types

**ZMTS-CNXXXX**  
**ZM2000-CNXXXX**                      **ZMTS-CIXXXX**  
**ZM2000-CIXXXX**

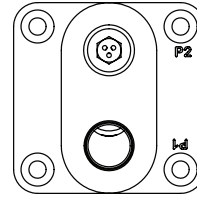
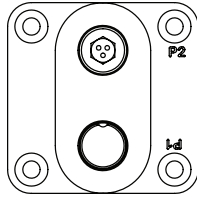

**ZMTS-DNXXXX**  
**ZM2000-DNXXXX**                      **ZMTS-DIXXXX**  
**ZM2000-DIXXXX**

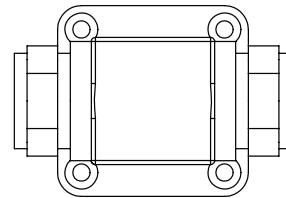
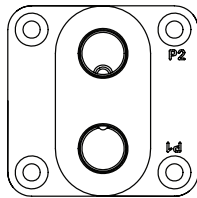

**ZMTS-ANXXXX**  
**ZM2000-ANXXXX**                      **ZMTS-AIXXXX**  
**ZM2000-AIXXXX**

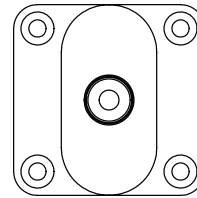
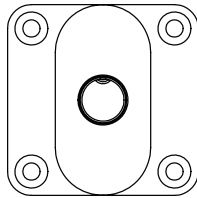

**ZMTS-RTD**

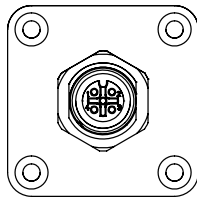

## ***Meriam Tethered Sensors (MTS)***

### Overview of the temperature and pressure sensors

1. The P2 sensor and the T2 sensor can be displayed with the P1 sensor.
2. When two sensors are displayed, no **Units** are displayed and the **Units** key is disabled.
3. The **Zero** key is also disabled.
4. When a single sensor is selected it displays the measurement units that were selected in meriSuite CG.

### Make an electrical connection

- Align the red dot on the Smart Manometer with the red dot on the Tether cable and push in.
- Align the red dot on the MTS with the red dot on the Tether cable and push in.

## ***How to zero Absolute sensors***

### Overview of the zeroing Absolute sensors

The Smart Manometer is a stable and precise instrument. However, on occasion the Smart Manometer should have a new zero taken. The new zero removes a zero drift that can occur after the Smart Manometer was last zeroed. The Smart Manometer can be zeroed only if the new applied zero is within  $\pm 1\%$  FS of the original factory calibration zero. This prevents accidental zeroing at atmospheric pressure or other relatively high pressures. If the Smart Manometer is outside this limit, the Smart Manometer cannot zero.

1. **Referenced to Absolute Zero** - This traditional and preferred method takes a snapshot of the measured pressure when a vacuum of less than 100 microns Absolute is applied to the sensor.
2. **Restore Factory Zero** - This method restores the calibration curve to the original zero taken at the factory.

*Note: This feature is intended for comparison purposes, and should not be used for real pressure measurement. This feature does not compensate for any zero drift.*

3. **User Defined Offset (Zero)** - With this method, you can enter any pressure value when a known reference is applied (for example, the local barometer). The Smart Manometer will

compare its actual measured value with the entered value, and calculate a new zero reference based on the offset.

## Steps for zeroing Absolute sensors

You can zero the Smart Manometer in one of three ways. The following may appear in a different order depending on which arrow key you press. When an absolute sensor displays on-screen as P1 or P2, press the **Zero** key to see one of the three sets of characters below and the following three messages

On-screen message	Explanations
TAP ✓ TO CHOOSE REF	<ul style="list-style-type: none"> <li>Tapping the <b>Accept</b> key selects the displayed reference.</li> </ul>
ARROWS TO CHANGE REF	<ul style="list-style-type: none"> <li>Tapping an <b>Arrow</b> key changes the displayed reference.</li> </ul>
X CANCELS	<ul style="list-style-type: none"> <li>Tapping the <b>Cancel</b> key cancels the zero request.</li> </ul>
ABS 0	<ul style="list-style-type: none"> <li>This is the on-screen abbreviation for <b>Absolute Zero</b>.</li> </ul>
dFLT	<ul style="list-style-type: none"> <li>This is the on-screen abbreviation for <b>Default</b>.</li> <li>If you want to restore the <b>Factory Zero</b> on a sensor, press the <b>Accept</b> key when you see these characters appear.</li> </ul>
USER 0	<ul style="list-style-type: none"> <li>This refers to <b>User Defined Offset (Zero)</b>. You can set an absolute reference point other than zero.</li> </ul>



## How to zero Differential or Compound sensors

1. Disconnect from a pressure source and vent the pressure port to atmosphere.

1. Do not remove the factory installed P2 plug if it is present.
2. The display should read close to zero.

2. Press the **Zero** key.

The top line displays dashes -----.



3. The process is complete when the Smart Manometer returns to the **Home** (Measurement Units) screen.
4. If someone has turned on the **Password Required For Future Access** feature in meriSuite CG, the password feature does not prevent you from zeroing the Smart Manometer.

*Note: You can only zero the Smart Manometer if the new zero value is within  $\pm 5\%$  (of FS) of the original factory calibrated zero. If the zero procedure generates a new zero reference outside this limit, the procedure fails. Factory service may be required.*

5. You can turn off the **Zero** function in **meriSuite CG** by deselecting **Allow zero adjust (Ø)** in the Display Functions list.

# Smart Manometer

## *Battery and USB power*

When you turn on the Smart Manometer, it draws power from the batteries and the battery icon displays in the bottom row. When you press the information button, it displays **Batt %**.

When you turn on the Smart Manometer and plug in the USB cable to the computer, the Smart Manometer switches to the power supplied by the USB cable. The battery icon disappears from the bottom row. When you press the information button, it displays **USB POWER**.

### **DANGER**

Do not use the USB in hazardous locations.

## *Batteries*

### **DANGER**

Remove and replace batteries in non-hazardous (safe) areas only.

### Turn off the backlight

- Turn off the backlight when you need to conserve battery power.
- The backlight is dimmed when the Smart Manometer is in low battery mode.

### Suggested brands of batteries

The following is a suggested list of batteries.

- Duracell MN1500
- Duracell PC1500
- Energizer EN91
- Panasonic LR6XWA
- Rayovac 815
- Varta 4906

### **DANGER**

For M2000X use only batteries listed on 9R698.

*Note: The Smart Manometer is powered by four 1.5 volt AA size batteries.*

## Know your batteries

- For M2000X use only batteries listed on 9R698.
- **Never** mix batteries—not by manufacturer or by size, by capacity, or by chemistry.
- **Never** mix old and new batteries.
- **Remove** all four batteries in the Smart Manometer at the same time.
- **Replace** all four batteries with batteries from the same package or with the same expiration date.

## Install the batteries

1. Turn over the Smart Manometer so the display faces down.
2. Remove the two screws on the battery cover with the Phillips-head screwdriver by turning them counterclockwise.
3. Insert the four AA batteries.

*Note: Pay attention to the positive (+) and negative (–) battery polarity markings at the bottom of the compartment.*

4. Replace the battery cover.
5. To secure the cover, torque the screws clockwise 2 in. lbs. maximum.
6. Do not over tighten.

### **NOTICE**

To prevent internal damage to circuitry, do not substitute screws with lengths that are different from the screws Meriam provided to you.

## Watch for the low battery indicator

The battery indicator on the display shows the current charge.

*Note: Be prepared to change batteries when you see the outline of the battery icon and the outline of the battery icon flashes. You have approximately 2 hours of run time following a low battery warning.*

## Refer to battery manufacturers' instructions

Visit the website of the battery manufacturer to learn more about the care, storage, shipping, use, disposal, and recycling of your batteries.

## The display

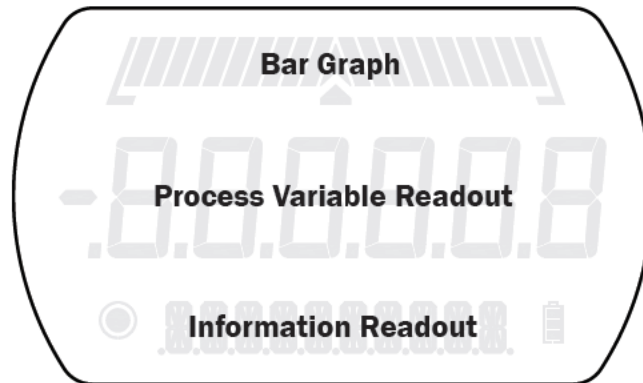

### The bar graph

The bar graph displays a live indication of the current pressure or temperature applied to a sensor as a percent of FS.

*Note: When you press the Information key, the bar graph displays the remaining state of the charge for the batteries.*

### Display functions

The Smart Manometer has twelve display functions. It ships with five display functions active (they appear in **bold** below). You can change which displays are active with meriSuite CG.

Press the **Forward** (or **Backward** in reverse order) key to view these modes.















- |                                                           |                        |
|-----------------------------------------------------------|------------------------|
| 1. <b>Home</b> is the default view with measurement units | 7. AVG (Average)       |
| 2. <b>MIN</b> (Minimum)                                   | 8. RATE                |
| 3. <b>MAX</b> (Maximum)                                   | 9. <b>DATA LOG</b>     |
| 4. RELIEF VALVE TEST                                      | 10. Temperature & Time |
| 5. + / - (Accuracy)                                       | 11. LEAK TEST          |
| 6. <b>T.OFF, T.ON</b> (Tare)                              | 12. LEAK TEST DURATION |

### Display function **NOT** appearing on the MTS

The following display function do not appear on an MTS when you attach it to the Smart Manometer.

- Temperature & Time.

## Keypad: Description of the keys

Name	Key	Description
Backward		<ul style="list-style-type: none"> <li>It cycles backward through menu options.</li> </ul>
Home		<ul style="list-style-type: none"> <li>Home key returns you to the <b>Measurement and Units</b> screen.</li> <li>Home key is disabled during tests and edits</li> </ul>
Forward		<ul style="list-style-type: none"> <li>It cycles forward through menu options.</li> </ul>
Units		<ul style="list-style-type: none"> <li>Select a measurement unit.</li> </ul>
Start		<ul style="list-style-type: none"> <li>Start key begins a test or data log.</li> </ul>
Stop		<ul style="list-style-type: none"> <li>Stop or Hold (Freeze) key.</li> </ul>
Up arrow		<ul style="list-style-type: none"> <li>It increases digits by one.</li> <li>It switches between the P1 and P2 sensors displays.</li> </ul>
Left arrow		<ul style="list-style-type: none"> <li>It moves the blinking cursor one space at a time to the left.</li> </ul>
Zero & Tare		<ul style="list-style-type: none"> <li><b>Zero</b> key resets pressure values to zero.</li> <li>It resets min max values.</li> <li>It sets edit values to zero.</li> <li>It resets relief valve test.</li> <li>As a <b>Tare</b> key, it turns off or turns on the Tare function.</li> </ul>
Right arrow		<ul style="list-style-type: none"> <li>It moves the blinking cursor one space at a time to the right.</li> </ul>
Down Arrow		<ul style="list-style-type: none"> <li>It decreases digits by one.</li> <li>It switches between the P1 and P2 sensors displays.</li> </ul>
Cancel or Esc		<ul style="list-style-type: none"> <li><b>Cancel</b> any editing or changes without saving.</li> <li>It also stops tests.</li> </ul>
Accept		<ul style="list-style-type: none"> <li><b>Accept</b> applies all editing and changes, and then saves them.</li> <li>It also stops tests.</li> </ul>
Power		<ul style="list-style-type: none"> <li>Turns the Smart Manometer on or off.</li> </ul>
Information		<ul style="list-style-type: none"> <li>Displays information about the Smart Manometer, internal sensor, attached MTS sensor, and the firmware.</li> </ul>

Name	Key	Description
Backlight		It provides three levels of brightness and off.

## The Information key and the Home screen

The Information menu provides you with details about the Smart Manometer and sensors.



Depending on what is attached to the Smart Manometer and depending on what is selected in the bottom row in the LCD display, determines what data appears.

1. **Batt %** displays the percentage on the bar graph and in digits or it displays the words **USB POWER**.
2. -- P1 -- or -- P2 -- or --  $\frac{1}{2}$  --

*Note: the bottom row indicates sensor (or measurement type): compound, absolute, or differential, or RTD temperature. All the following sensor information describes the sensor indicated by P1 or P2.*

3. **CAL DATE**
4. **USL** is an abbreviation for *upper sensor limit*.
5. **LSL** is an abbreviation for *lower sensor limit*.
6. **LT MAX %** displays the Life-Time Maximum that has been reached on the sensor.
7. **SENSOR F/W VERS** F/W is an abbreviation for *firmware (this message scrolls to display the information)*.
8. **SENSOR S/N** S/N is an abbreviation for *serial number (this message scrolls to display the information)*.
9. **SNSR NAME** *[this message scrolls to display the information]*.
10. **DEV F/W VER** DEV is an abbreviation for *device; it refers to the M2000 (this message scrolls to display the information)*.
11. **DEV S/N** *(this message scrolls to display the information)*.
12. **DEV NAME** refers to the Smart Manometer *(this message scrolls to display the information)*.

## Up and Down Arrows

In the edit mode, the **Up Arrow** increases the digit each time you press it. The **Down Arrow** decreases the digit



1. **Up Arrow:** 0 to 1 to 2 to 3 to 4 to 5 to 6 to 7 to 8 to 9.
2. **Down Arrow:** -0 to -1 to -2 to -3 to -4 to -5 to -6 to -7 to -8 to -9.
3. The negative symbol in the display appears in front of the first digit when it is required.

## The backlight

### White backlight

The white backlight has an automatic time out. If you do not press any keys while the backlight is on, it automatically turns off after 1 minute.

*Note: You can configure the backlight timeout using meriSuite CG.*

### Levels of backlight intensity

Press the Backlight key to cycle through these choices:

- Low.
- Medium.
- High.
- Off.

### Flashing red backlight

The flashing red backlight indicates an error condition. Possible error conditions are:

- Pressure has exceeded the calibrated accuracy of the Smart Manometer.
- Pressure has fallen below the stated accuracy of the M2000.

*Note: The red backlight overrides the white backlight.*

## Overrange condition

During an error or overrange condition, the red backlight **overrides** the white backlight.

However, once the error or overrange condition is corrected, the white backlight is restored to its previous state (if the backlight **Auto Off** timeout did not expire).

## Measurement units

### A measurement unit doesn't display

#### NOTICE

If a given measurement unit cannot display the correct number of digits, the Smart Manometer automatically advances to the next displayable unit.

*Note: When you turn on the Smart Manometer, it defaults to the last selected measurement unit.*

### Measurement units are stored on a sensor

The meriSuite CG application gives you the ability to configure specific measurement units on specific sensors.

A total of 32 measurement units are available in meriSuite CG. When the Smart Manometer is shipped, 12 measurement units are active. The 12 units appear in **bold type** in the following list.

#### Standard Measurement Units (non-custom)

1. <b>PSI</b>	12. CMW4C	23. KG/M2
2. <b>INW20C</b>	13. CMW60F	24. <b>PA</b>
3. INW4C	14. MW2OC	25. HPA
4. <b>INW60F</b>	15. MW4C	26. <b>KPA</b>
5. FTW2OC	16. MW60F	27. MPA
6. FTW4C	17. <b>INHG0C</b>	28. <b>BAR</b>
7. FTW60F	18. MGH0C	29. <b>MBAR</b>
8. <b>MMW20C</b>	19. CMGH0C	30. ATM
9. MMW4C	20. <b>MMHG0C</b>	31. <b>OZ/IN2</b>
10. MMW60F	21. TORR	32. LB/FT2
11. CMW2OC	22. <b>KG/CM2</b>	



## ***Damping***

### Damping rate

Select a **Time Constant**: 1 second, 2 seconds, 4 seconds, 8 seconds, or 16 seconds.

- When set for 4 second time constant, it takes 4 seconds from the time of the step change until the Smart Manometer displays the full value of the new pressure.

### Damping types

Select a **Type**: Exponential, Smart Quick, Smart Normal, or Smart Slow.

- Use adjustable **Exponential** type damping to steady the display when you measure pulsating pressure or flow.
- **Exponential** damping displays approximately 70 % of a step change in pressure at the next display update.

## Data Logging

### Review settings before starting a data log

To review the settings on the Smart Manometer before starting a new data log, follow these steps:

1. From the **Home** screen, press the **Backward** or **Forward** key until you see DATA LOG.
2. Press the **Information** key to view these seven settings:

Description	Information	Information
<i>VERS.</i>	<b>PRO</b> (optional)	<b>LITE</b>
<i>AVAIL.PTS</i>	maximum number of points 100 000	maximum number of points 240
<i>AVAIL.LOG</i>	maximum number of logs 128	maximum number of logs 1
<i>TYP.</i>	<b>MEAS, AVG, AVG+PK, DEMAND</b>	<b>MEAS</b>
<i>INTERVAL</i>	seconds are expressed in decimal points	seconds are expressed in decimal points
<i>PTS.CFG.</i>	100 (when time is configured, points is blank)	n/a
<i>TIME.CFG.</i>	----- (when points are configured, time is blank)	n/a

### Starting a data log

1. From the Home screen, press the **Backward** or the **Forward** keys until you see *DATA LOG* on screen.
2. Press and hold the **Start** key until -- *STARTING* -- appears in the display. Data Logging continues for the defined time or the defined number of points.
3. *SNSR ERROR* - means one of the sensors reported an error after the test began. This will stop the Data Log. **Sensor Error** will appear in the Data Log Pro log.
4. While *DATA LOG* is running, you may press the **Information** key to see how much time is remaining for the active log.

### Stopping a data log

To stop the Data Log at any point or at any time, press and hold the **Stop** key until -- *STOPPING* -- appears.

## Leak Test

The Leak Test determines the leak rate in the system you are monitoring.

### NOTICE

The timeout setting for **Auto Off** (Automatic Shut Off) is automatically suspended during a Leak Test session.

### Review or change the LEAK TEST DURATION setting

Starting from the **Home** screen:

1. Press the **Backward** key to view the **Leak Test Duration** screen.
2. If you want to change the duration, follow the on-screen instructions *LEAK TEST DURATION TAP ✓ TO CHANGE*.



3. *TAP ✓* - Pressing the **Accept** key starts the first digit blinking.
4. Use the **Right Arrow** key to move the blinking cursor to the first zero you want to change.

*Note: The on-screen scrolling message reminds you to enter a number from 0.1 - 1440 (1440 minutes is 24 hours).*

5. Press the **Up Arrow** key until you see the number you need and continue to use the **Right Arrow** and **Up Arrow** keys until you have the total number of minutes you require.
6. You have three choices after entering minutes for duration:
  1. ✓ *SAVES* (the **Accept** key).
  2. X *CANCELS* (the **Cancel** key).
  3. □ *CLEAR5* to start over (the **Zero "0"** key).
7. After reviewing or changing these settings, press the **Backward** key to go to the screen to start the Leak Test.

### Fix a RANGE ERR issue

1. The first zero digit is blinking.
2. Press the **Zero "0"** key to reset all numbers to zeros and enter a valid number of minutes from 0.1 - 1440.



## Start the Leak Test

Starting from the **Home** screen:

1. Press the **Backward** key a second time if you do not want change the duration and *TAP START TO BEGIN*. (*START* is referring to the **Start** key).



2. The numbers blink to indicate when the test has stopped. This screen displays the results of the Leak Test with the calculated leak rate in units per minute.
3. After the test has stopped, press the **Forward** key to review the MIN value, and then the MAX value, and then you can select an *- - □ □ □ -* option to exit the test by pressing either the **Cancel** or **Accept** keys.

*Note: MIN is the minimum pressure measured during the test.  
MAX is the maximum pressure measure during the test.*

*Note: Starting a Data Log is different than starting a Leak Test.  
Data Log requires pressing and holding the **Start** key until you see the word **Starting**. In a Leak Test press and release the **Start** key (the on-screen message refers to this action as *TAP*).*



## Stop a Leak Test

### **It stops automatically when it counts down to zero**

1. After the Leak Test counts down to zero, the digits begin to blink to indicate the Leak Test has stopped.
2. Press the **Forward** key to cycle through these options:
  1. *MIN*
  2. *MAX*
  3. *✓ OR X TO EXIT TEST*
3. Press the **Home** key to exit Leak Test.

### **Exit the test during the count down to zero**

1. Press the **Cancel** key or the **Accept** key to exit the test.
2. Press the **Home** key to return to the Home screen.

## Relief Valve Test

### Starting the Relief Valve Test

To start the Relief Valve Test follow these steps:

1. Press the **Forward** key until you see *RELIEF VALVE TEST TAP START TO BEGIN*



2. *MAX TEST P* displays when the test begins. (MAX is the maximum pressure measured during the test.)
3. Press the **Forward** key to see *MIN TEST P* value. (MIN is the minimum pressure measured after reaching MAX and pressure starts releasing. If a new MAX is reached, MIN resets.)
4. Press the **Forward** key and you see *- - 0.00 - -*.

*Note: At this point, you see options available to you during the Relief Valve Test.*

1. *✓ OR X TO EXIT TEST* (use either option to exit)



2. *0 TO RESET MIN + MAX* (the **Zero** key)



3. *STP-FREEZE* When you press the **Stop** key, *HOLD.ON* briefly appears and the current value remains on-screen blinking.



Press the **Zero** key and *HOLD.OFF* appears and new values continue to display.

5. Press the **Forward** key to see *MAX TEST P* value.

## Stopping the Relief Valve Test

At any time during the test you may

1. Press the **Stop** key and the *HOLD . ON* message appears. The digits continue to blink to indicate the hold status.
2. Press the **Zero** key to turn off the hold status and the *HOLD . OFF* message appears. The test restarts.
3. Press the  $\checkmark$  *OR* *X* to exit the test. The results are lost when you use these keys.

## Differential displays

When you first turn on the Smart Manometer, you see the **Home** screen and the internal sensor information displays first. Press the **Up arrow** and external sensor information displays.

- Press the **Up arrow** again and information for both the internal and external sensors displays. The internal sensor displays in large characters while external sensor information displays in small characters.
- Press the **Up arrow** and *Diff P1-P2 scrolls* with P1 Units (internal measurement units).

*Note: Differential displays are not available if either pressure sensor is a differential sensor or tethered sensor is a temperature sensor.*

- Press the **Left or Right arrow** and *Diff P2-P1 scrolls* with P2 units (external measurement units).
- Press the **Left or Right arrow** and *Diff P1-P2 scrolls* with P1 units (internal measurement units).
- Press the **Down arrow** to reverse the sequence.
- Press the **Home** key at any point to return to the **Home** screen.

## Auto Off (Automatic shut off)

How long will the Smart Manometer remain on if I leave it unattended?

- The default setting is **Always On**.
- You can configure the timeout for the Auto Off with meriSuite CG.

### NOTICE

- The Auto Off timeout is suspended during **Data Logging** and **Leak Test sessions** to prevent accidental loss of data.
- Auto Shut-Off automatically restarts after Data Logging or Leak Test sessions stop.

## ***What does the Zero (ø) key do?***

### In normal measure mode

If the sensor is within a tolerance band around zero, press and hold the **Zero** key to zero the pressure measurement and to reset the Min and Max measurements.

*Note: The tolerance band is approximately  $\pm 1\%$  of the FS pressure value of the sensor.*

### In Min or Max mode

Press and hold the **Zero** key to reset the MIN and MAX measurement. However, this does not zero the pressure measurement.

### In Tare mode

When the Tare is off (T.OFF), press and hold the **Zero** key to turn on Tare (T.ON) and to set the Tare value at the current pressure measurement.

Likewise, when the Tare is on (T.ON), press and hold the **Zero** key to turn off the Tare mode.

### In Average mode

Press and hold the **Zero** key to restart the rolling average.

### Holding the Zero key

The key must be held to perform the Zero or Tare mode. The displayed value(s) dashes out during the zero or tare process.



# meriSuite CG application

## *How does meriSuite CG benefit you?*

*Note: meriSuite CG is not required to operate the M2000.*

- You can configure your Smart Manometer or sensor to display information the way your company needs to use it.
- You can configure data logging requirements and Data Log Pro.
- You can perform your own calibration.
- You can update the Smart Manometer in the field.

## *meriSuite CG and USB Drivers required*

### First—Install meriSuite CG

1. Read the [meriSuite CG Installation Instructions 9R606](#) on the **Downloads** page on \_\_\_\_\_
2. The instructions have a link that you can click to download the meriSuite CG setup file.
3. Follow the on-screen instructions.

### Second—Install USB Drivers

1. Read the [USB Drivers Installation Instructions 9R607](#) on the **Downloads** page on \_\_\_\_\_
2. The instructions have links that you can click to download the required USB Driver.
3. Follow the on-screen instructions.

## Tips for using meriSuite CG

### USB cable and your computer

**⚠ WARNING**

**For use only in non-hazardous locations (safe locations)**

Connect the USB cable to your Smart Manometer and to your computer to configure any sensors you wish to include.

**⚠ CAUTION**

Use only the supplied USB cable when you connect to the USB port.

### Close meriSuite CG first, then turn off your Smart Manometer

**NOTICE**

Do not turn off the power on the Smart Manometer while it is communicating with meriSuite CG. The Smart Manometer displays dashes and the words *USB ACTIVE* while meriSuite CG is communicating with a Smart Manometer or sensor.

- Close meriSuite CG first, disconnect the USB, and turn off your Smart Manometer.
- As long as *USB ACTIVE* remains visible, Auto Off is suspended.

## Watch for a yellow dot on an active tab

- A yellow dot appears on a tab in meriSuite CG to indicate that you have made changes to settings but you have not saved them yet. See Figure 1 and Figure 2 below.
- You may click the **Write** button to save the changes you made.

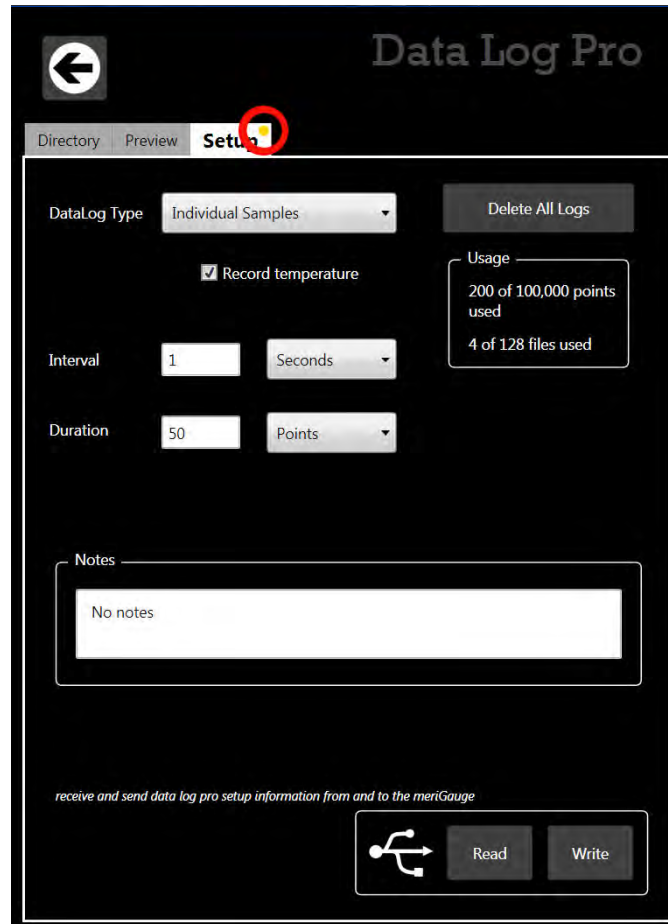

## Watch for a yellow dot on an inactive tab

Yellow dot on an inactive tab. See the red circle in the figure below.

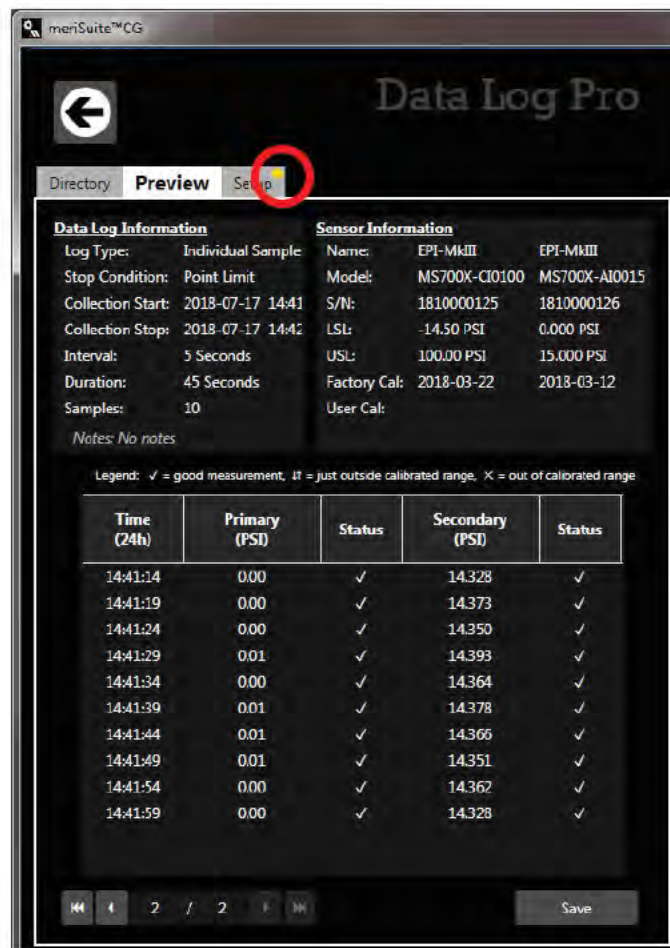

## Year-Month-Date format

- The meriSuite CG application displays the date in year-month-day format.
- For example: 2016-04-22 (YYYY-MM-DD).

## Hours:Minutes:Seconds format

- The meriSuite CG application displays the time in 24-hour format.
- You may choose from Time Zones:
 

Universal Coordinated Time (UTC)	US - Arizona -7:00
US - Eastern -5:00	US - Pacific-8:00
US - Central -6:00	US - Alaska -9:00
US - Mountain -7:00	US - Hawaii -10:00
- For example: 15:05:45 UTC (hours:minutes:seconds).

## Connection status

### Attached devices

The meriSuite CG application displays the figures of the Smart Manometer and tethered sensor. Descriptions appear alongside both of them. *See the figure below.*



## No attached devices

The meriSuite CG application displays no figure of devices on the right side. See the figure below.

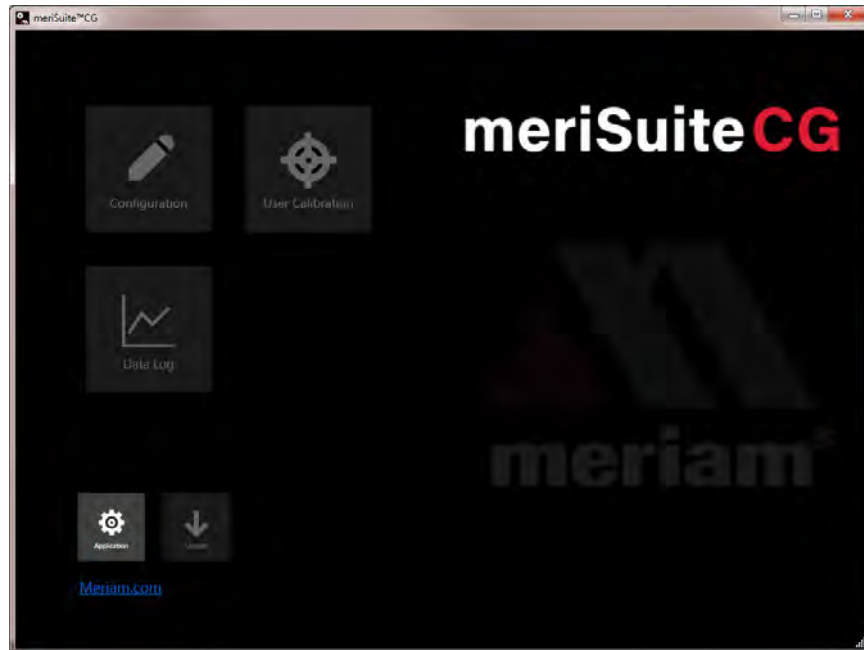

## No tethered sensor attached

Notice the figure of the Smart Manometer and description. See the figure below.



## Configuration button

### Overview of the Configuration button



The **Configuration** button displays a window with two tabs if a tethered sensor is attached:

- The first tab displays the Smart Manometer name or the name you assigned to it.
- *Optional: this second tab displays the tethered sensor name or the name you assigned to it.*

*Note: These tabs offer you various settings to configure the Smart Manometer and each sensor.*

### Notification about unsaved settings



It displays a **yellow alert icon** to indicate you have changed a setting and you have not yet saved the setting.

## Passwords

### Overview of passwords

Passwords are never required to use a Smart Manometer or any sensor.

- The passwords are turned off when the Smart Manometers and sensors are shipped.
- Each device can have its own unique 16-character password. You may use from 1-16 characters: letters, numbers, or symbols, and uppercase and lowercase.
- An internal sensor and a tethered sensor have their own separate passwords.
- Each device can have its password turned on or turned off independently from any other tethered sensor.
- meriSuite CG retrieves the passwords stored on the devices.

**meriSuite CG uses the password**

If you choose to select the **Password Required For Future Access**, then meriSuite CG requests a password for the following actions:

- To modify a configuration.

*Note: This action includes writing to or reading from a device.*

- To update the firmware on a device or the application.
- To calibrate a device.
- To access the Setup tab of Data Log Pro.

**meriSuite CG remains unlocked**

- Once meriSuite CG accepts a password for one of those actions, the device remains unlocked until it is disconnected from meriSuite CG.
- If you enter the password on one window, meriSuite CG unlocks that Smart Manometer or sensor on its other windows as well.

**Data Log Lite has no password**

meriSuite CG does not use a password for Data Log Lite since it cannot make any changes to the device.

**Recovery password valid for one date**

When you call Meriam to generate a recovery password, you may select a date that is convenient for you. If you do not specify a date, the request date is used.



## Common features for a Smart Manometer and sensor(s)

### The Names field

You can assign your own company designations to each device.

### As Left / As Found Configuration Report button

- You can review a summary of the configuration of the Smart Manometer or sensor when it is first connected and the changes you made.
- The **As Found / As Left Report** cannot report changes made in meriSuite CG unless you save those new configurations to the device.

### Read and Write Configurations

- **Read** and **Write** refer to reading configuration data from a Smart Manometer or sensor or writing new data to them.

#### **NOTICE**

Save your configuration changes before you click the **Read** button. After you click the **Read** button, all changes on-screen are replaced with the configuration that is on the device.

## Configuring devices

### Sync PC time to Gauge

- Click to update the Smart Manometer time and date with your computer.
- The LCD display and data logging use this time and date.

### Timeouts

- Backlight.
- Auto Off (Automatic Off).

### Display Functions

- Min/Max.
- Accuracy.
- Tare.
- Average.
- Rate of Change.
- Relief Valve Test.
- Time & Temp.
- Data Log.
- Allow zero adjust (Ø)
- Leak Test.

## Configuring sensors

### Enabled Units

Select or deselect measurement units to view them on the Smart Manometer. They are saved on each sensor.

- The **All** button selects all measurement units.
- The **None** button deselects all measurement units.
- You must select at least one unit before you can **Write** to the sensor.

### Two User Defined Units

You can define the **Name**, **Multiplier**, **Offset**, and **Function** for two non-standard or unsupported display units.

*Note: Flow type does not use Offset.*

*Note:  $(\text{multiplier} \times \text{PSI}) + \text{Offset} = \text{the displayed value for linear type.}$*

## Damping

### No settings on the Smart Manometer

You cannot set the Damp Rate on the Smart Manometer. You have to click the **Configuration** button in **meriSuite CG** to change the Damp Rate.

### Damping rate

Select a **Time Constant**: 1 second, 2 seconds, 4 seconds, 8 seconds, or 16 seconds.

- When set for 4 second time constant, it takes 4 seconds from the time of the step change until the Smart Manometer displays the full value of the new pressure.

### Damping types

Select a **Damp Type**: Exponential, Smart Quick, Smart Normal, or Smart Slow.

- Use adjustable **Exponential** type damping to steady the display when you measure pulsating pressure or flow.
- **Exponential** damping displays approximately 70 % of a step change in pressure at the next display update.

## User Calibration button

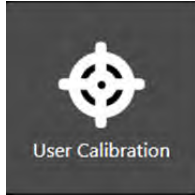

The **User Calibration** button displays options to calibrate the sensor.

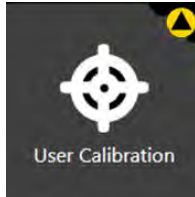

The **User Calibration** button displays a **yellow alert icon** to indicate you have changed a setting and you have not yet saved the setting to the Smart Manometer.

User Calibration: For authorized personnel only

### What does “Calibration Enabled” refer to?

- With a check mark in the box, Calibration Enabled displays the **Live Reading** with your current user calibration applied.
- Without a check mark in the box, it displays **Live Reading** without your user calibration.

### Restore Factory Defaults

This button clears your user calibration from the sensor.

### Choose Calibration Unit

- Select the calibration reference units.
- This does not affect or depend on the configuration units.

### Begin button...Apply button

1. Click **Begin**.
2. Select the point.
3. Apply reference pressure within the range shown.
4. Enter the reference value.
5. Save the point.
6. Repeat steps 2-5 until you are done. (You have to change at least one point.)
7. Click the **Apply** button.

## Customer calibration

You can calibrate the manometer in the field for

1. Zero.
2. Span.
3. Linearity.

The customer calibration does not replace the Factory Lab Calibration Procedure. It is intended to correct the curve fit if the actual sensor characteristics change slightly over time.

For sensors up to 200 psi, Meriam recommends a  $\pm 0.0015$  % of reading deadweight tester. For sensors 200 psi and above, a  $\pm 0.0030$  % of reading deadweight tester is recommended. Note that AI type sensor requires absolute referenced deadweight testers or standards for field calibration. The options are:

1. 2-point (within upper 50 % of FS)
2. 5-point (nominal values of 0 %, 25 %, 50 %, 75 % and 100 % of FS).
3. Restore factory default calibration.

For the 5 Point calibration, points 2, 3 and 4 can be adjusted within  $\pm 1$  % of reading around the nominal values. Point #5 can be adjusted within -1 % of reading around nominal. Point #1 is fixed.

The unit can only be calibrated if the calibration points are within 5 times the accuracy of the original factory calibration

For example: at 0.05 % accuracy, the point limit is  $\pm 0.25$  % of FS.

If the calibration procedure generates a new value outside this limit the procedure fails. In this case the unit would need to be returned to the factory for service.

After a calibration has been performed (either 2-point or 5-point), the sensor uses only that calibration. To turn on another calibration type, you must first **Restore Factory Defaults** and then choose another calibration method.

## Data Log button

### Overview of Data Log buttons

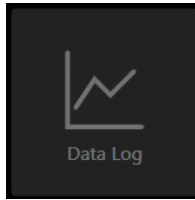

Data logging displays three different buttons depending on what you order or on what you add-on at a later time. The **Data Log** button is always *unavailable* until the USB cable is attached to the computer with meriSuite CG.

### Data Log Lite



The **Data Log Lite** button displays when you attach a Smart Manometer. Data Log Lite is the free version of data logging. It has ***no options***.

### Data Log Pro

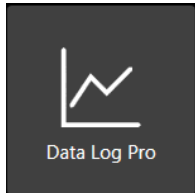

The **Data Log Pro** button displays when Data Log Pro is activated on the Smart Manometer that is attached to meriSuite CG.

### Data Log Pro alert

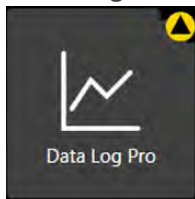

The button displays a **yellow alert icon** to indicate you have changed a setting and you have not yet saved the setting to the Smart Manometer.

## Data Log Lite

### Preview tab

#### *Preview the data log*

The Preview tab displays the first 10 samples so you can confirm the data to save. If you have fewer than 10, it displays all of your samples.

#### *Status and pressure for logs*

The Status symbols for pressure and temperature.

The ✓ symbol corresponds to readings that are within the calibrated range.

- The ↓↑ and × symbols indicate an abnormal condition.
- The ↓↑ symbol indicates readable data.
- The × symbol indicates dashes and no readable data.

#### *The Pressure*

The pressure indicates the reading at each 15-second interval in the data set.

#### *The Temperature*

- The MTS displays when it is attached (pressure or temperature).
- Temperature displays *only* when the MTS RTD is attached.

## ***TSV file format***

### Overview

**Configuration, Data Log Lite, and Data Log Pro** provide you with the option to save Configuration Reports and Data Log files in TSV file format.

### Two ways to open TSV files

#### **Double click a TSV file**

Double click a TSV file in Windows Explorer and if it opens in a spreadsheet application, then you do not need to do anything additional.

**Examples of spreadsheet applications:** *Microsoft Excel, Google Sheets, and OpenOffice Calc.*

#### **Drag and drop a TSV file into a spreadsheet**

Drag and drop TSV files to open them. The following steps are similar for these spreadsheet applications: Microsoft Excel, OpenOffice Calc, and Google Sheets.

1. Open **File Explorer** (Windows 8 and 10). Keep File Explorer small enough to see Excel in the background.

*Note: Depending on which version of Windows you have, File Explorer may be known as Windows Explorer, File Manager, or My Computer.*

2. Open **Excel**. It can have a blank spreadsheet or an existing spreadsheet. Drag and drop creates a new spreadsheet.
3. Switch to **File Explorer** and navigate to the location where you saved the TSV file.
4. Select the file and drag-and-drop it in the middle of the blank spreadsheet.
5. Save it as an **Excel** file.

## Look for page breaks if you want to print a TSV file

Excel has a feature called **Page Break Preview** to show you where the page breaks occur in the log file. Change the page breaks, rows to repeat at the top, and other settings as necessary so your printers do not waste paper.

*Note: Other spreadsheet applications offer similar features.*

In the figure below, the file would print on at least four pages.

Data Log Lite by Meriam Process Technologies					
Data Log Information					
Collection Date	4/25/2016				
Interval	15 Seconds				
Duration	21.75 minutes				
Samples	88				
Sensor Information					
Name	meriSense				
Model	MS700-CI0100				
S/N:	1607000068				
LSL:	-14.5 PSI				
USL:	100 PSI				
Factory Cal	2/8/2016				
User Cal					
Sample	Time (24h U-4:00)	Pressure (in range)	Pressure (over range)	Temperature (in range)	Temperature (over range)
1	15:12:06	-0.01		21.6	
2	15:12:21	-0.01		21.6	
3	15:12:36	-0.01		21.6	
4	15:12:51	-0.01		21.6	
5	15:13:06	-0.01		21.6	
6	15:13:21	-0.01		21.6	
7	15:13:36	-0.01		21.6	
8	15:13:51	-0.01		21.6	
9	15:14:06	-0.01		21.7	
10	15:14:21	-0.01		21.7	
11	15:14:36	-0.01		21.8	
12	15:14:51	-0.01		21.8	
13	15:15:06	-0.01		21.8	
14	15:15:21	-0.01		21.8	
15	15:15:36	0		21.9	
16	15:15:51	0		21.9	
17	15:16:06	-0.01		21.9	
18	15:16:21	-0.01		22	
19	15:16:36	-0.02		22.1	
20	15:16:51	-0.01		22.2	
21	15:17:06	-0.01		22.3	
22	15:17:21	-0.01		22.3	
23	15:17:36	-0.01		22.3	
24	15:17:51	-0.01		22.3	
25	15:18:06	-0.01		22.4	
26	15:18:21	-0.01		22.3	
27	15:18:36	-0.01		22.3	
28	15:18:51	-0.01		22.3	
29	15:19:06	-0.01		22.4	
30	15:19:21	-0.01		22.4	
31	15:19:36	-0.01		22.5	
32	15:19:51	-0.01		22.4	



## Upgrade tab

The **Upgrade** tab provides you with an **Enter Activation Key** edit box and an **Activate Device** button to replace Lite with Pro.

*Note: The Activate Pro button remains unavailable until you enter an activation key number.*



## Data Log Pro

Data Log Pro is an optional purchase

### List of benefits

You can:

- Log 100 000 data points.
- Set data logging intervals from 1 second to 24 hours.
- Set one of four data logging types.
- Select the duration.
- Save logs to two file formats: TSV and PDF format.

### How many licenses do I need to operate Data Log Pro?

*Do I need a license for each Smart Manometer?*

- Yes. One license covers one Smart Manometer and an unlimited number of sensors, copies of meriSuite CG, and computers.
- This license policy differs from some application licenses.

*Do I need a license for each computer (meriSuite CG)*

- No.

*Do I need a license for each sensor?*

- No.

## Data logging

### NOTICE

- The Auto Off (automatic shutoff) timeout is suspended for Data Logging sessions.
- Make sure to end the session to restart the Auto Off timeout.

## Order Data Log Pro or add it later

### **Order it installed**

You can order it so the Smart Manometer comes loaded and ready to use when you receive it. The **Data Log Pro** button appears on the meriSuite CG dashboard when the device is connected.

### **Add it later**

You may add Data Log Pro at any time by calling your distributor

- You must have the **serial number** from the Smart Manometer.
- You can find it on the back of the device or you can view it in the meriSuite CG application.
- After you purchase Data Log Pro, your distributor or the Meriam Sales Team will give you an **Activation Key**.

### **Enter the activation key**

- Click the **Upgrade** tab in **Data Log Lite** to enter the Activation Key.
- After you click the **Activate Device** button, **Data Log Pro** automatically replaces *Data Log Lite* in meriSuite CG dashboard.

## Directory tab

### View the list of logs on the Smart Manometer

The **Directory** tab displays all the logs in the memory of the connected Smart Manometer. Two ways to open a log:

- Double click a log to open it in the **Preview** tab.
- Or, you may select a log from the list and click the **Preview** tab to view it.

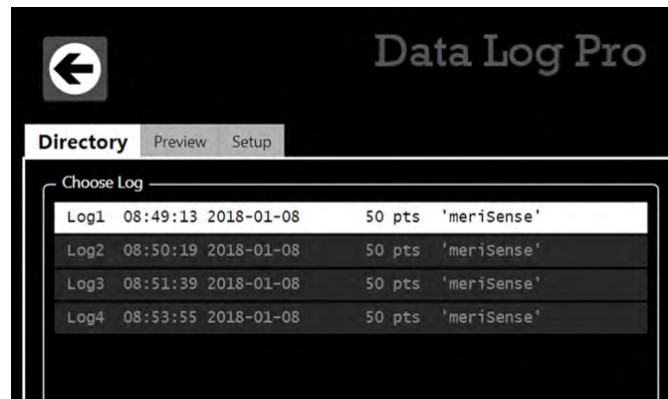

## Preview tab

### Overview of the Preview tab

When you double click a log in the **Directory** tab, the **Preview** tab opens.

**Data Log Pro**

Directory **Preview** Setup

Data Log Information		Sensor Information	
Log Type:	Individual Sample	Name:	EPI-MkIII EPI-MkIII
Stop Condition:	Point Limit	Model:	MS700X-CI0100 MS700X-AI0015
Collection Start:	2018-06-14 14:16	S/N:	1810000125 1810000126
Collection Stop:	2018-06-14 14:17	LSL:	-99.97 kPa 0.000 PSI
Interval:	5 Seconds	USL:	689.48 kPa 15.000 PSI
Duration:	45 Seconds	Factory Cal:	2018-03-22 2018-03-12
Samples:	10	User Cal:	

Notes: No notes

Legend: ✓ = good measurement, ! = just outside calibrated range, ✗ = out of calibrated range

Time (24h)	Primary (kPa)	Status	Secondary (PSI)	Status
14:16:20	0.00	✓	14.352	✓
14:16:25	0.00	✓	14.350	✓
14:16:30	0.00	✓	14.350	✓
14:16:35	0.00	✓	14.350	✓
14:16:40	0.00	✓	14.350	✓
14:16:45	0.00	✓	14.350	✓
14:16:50	0.00	✓	14.349	✓
14:16:55	0.00	✓	14.349	✓
14:17:00	0.00	✓	14.349	✓
14:17:05	0.00	✓	14.349	✓

1 / 4 Save

### The Preview tab contains seven areas of information:

1. Data Log Information list.
2. Sensor Information list.
3. Notes.
4. Legend.
5. Samples table.
6. Navigation bar.
7. Save button.

### ***Details about the Preview tab***

#### *1. Data Log Information list*

A description of items in this list:

1. **Log type** indicates the type that was selected in the Setup tab when the log was created.
2. **Stop condition** indicates why the log stopped.

**List of stop conditions:** Manual Stop, Data Complete, Time Limit, Point Limit, Storage Limit, Low Power, Sensor Removed, PC Connection, or Sensor Error

3. **Collection Start** indicates the day and time the log began.
4. **Collection Stop** indicates the day and time the log ended.
5. **Interval** is how often data is saved but the Interval does not display with the *On Demand* option.
6. **Duration** displays how long the log actually recorded data. This may or may not be the Duration you selected in the Setup tab. Check the Stop condition.
7. **Samples** indicate the number of readings in the log. They reflect how many data points were saved.

#### *2. Sensor Information list*

- All information in this list was retrieved from the internal sensor (and from an MTS if one was attached) at the time the Smart Manometer recorded this particular log.

#### *3. Notes*

- Any information that displays here comes from the text you enter in the **Notes** box in the Data Log Pro **Setup** tab.

#### 4. Legend for the status columns

The samples table has two columns for Status. The legend provides three symbols to indicate the level of confidence for pressure or temperature measurements.

1. The ✓ symbol corresponds to readings that are within the calibrated range.
2. The ↓↑ and × symbols indicate an abnormal condition.
3. The ↓↑ symbol indicates readable data but it is out of range.
4. The × symbol indicates dashes on the Smart Manometer and no readable data.

#### 6. Navigation bar

- This bar provides you with buttons to jump to the first log or to the last log.
- The bar also provides you with buttons to navigate to the previous log or next log.
- The numbers in the bar indicate which log out of the total number of logs on the Smart Manometer that you are currently viewing.

#### 7. Save button

Click the **Save** button on the right side and the **Save As** box appears. You can save the file in two file formats:

- PDF.
- TSV.

## Setup tab

### Overview of the Setup tab

- The Setup tab lists parameters you may change. It gives you usage statistics and it displays three action buttons.
- A yellow dot appears on this tab after you changed a setting and have not saved it.

### Parameter Choices

#### *Four data logging types*

1. **Individual Samples** refers to actual measurements taken at fixed intervals.
2. **Average only** refers to average measurements over the intervals you selected. It takes measurements every 200 ms.
3. **Average with peaks** refers to average measurements over the intervals you selected. It also saves the maximum and minimum measured values during the interval you saved. It takes measurements every 200 ms.
4. **On Demand** refers to manually recording actual measurements rather than at fixed intervals.

#### *Interval types*

You can select **Seconds**, **Minutes**, or **Hours** from a drop-down menu and enter a number.

#### *Duration types*

- You can select: **Minutes**, **Hours**, **Days**, **Forever**, or **Points** and enter a number.
- Selecting **Forever** makes the number box disappear.

*Note: **Forever** is limited by the remaining number of points on the Smart Manometer. Look for these numbers on the Usage box to the right of Interval.*

### Notes edit box

Notes you enter in this edit box appear in the Preview tab, the TSV file, and the PDF file. This field is limited to 64 characters.



### Usage statistics

Usage presents the amount of memory available on the Smart Manometer for data logging in two ways:

1. The number of data points used out of a maximum of 100 000.
2. The number of logs used out of a maximum of 128.

### Delete All Logs

This button deletes all the logs on the Smart Manometer. This does not affect the files you saved to the computer in the **Preview** tab.

*Note: If the Smart Manometer has a password, then clicking this button requires you to enter a password. This password was created in the **Configuration** tab for a sensor.*

### Read

#### NOTICE

Save your configuration changes before you click the **Read** button. After you click this button, all changes on-screen are replaced with the configuration that is on the Smart Manometer.

*Note: If the Smart Manometer has a password, then clicking this button requires you to enter a password. This password was created in the **Configuration** tab for internal sensor.*

Press this button, Data Log Pro reads the parameters from the Smart Manometer and displays them in the **Setup** tab.

### Write

This button remains unavailable until you make a change in the **Setup** tab. It saves the new setup parameters to the Smart Manometer and overwrites the parameters stored on the Smart Manometer.

*Note: If a sensor has a password, then clicking this button requires you to enter a password. This password was created in the **Configuration** tab.*

## Application button

### Overview

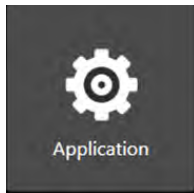

The Application button displays a window with three sections about the **meriSuite CG** application:

- About.
- Available Update.
- Language Selection.

### Application notifies you of available updates

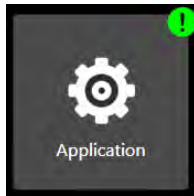

It displays a green alert icon with an exclamation mark to indicate an *Available Update*. After clicking this button, it displays the following message:

*"PLEASE BE ADVISED! If you choose to install the update at this time, you will lose unsaved configuration information or data log setup changes. Be sure to save that information to a file or **Write** it to the connected device."*

### Application notifies you of no internet connection

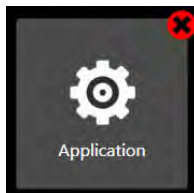

It displays a red alert icon with an "x" to indicate"

*"There is no connection to the update server. This is usually caused by the PC not having internet connectivity or the server may be temporarily unavailable."*

## Update button

### Overview

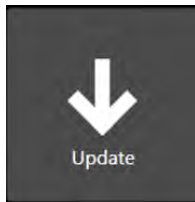

The **Update** button displays a window with multiple sections:

- The **first** section alerts you to updates for the sensor and the Smart Manometer.
- The **second** section alerts you to updates for **each** sensor that you attach to the Smart Manometer.

### Update notifies you of available updates

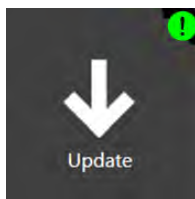

It displays a **green alert icon** to indicate an update is available for the firmware in the sensor or the Smart Manometer.

### Update notifies you that you have no internet connection

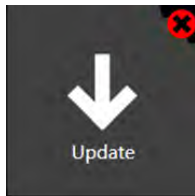

It displays a **red alert icon** to indicate:

*“There is no connection to the update server. This is usually caused by the PC not having internet connectivity or the server may be temporarily unavailable.”*

# Specifications

## *Internal sensors: type and range*

Isolated: ZM2000 - (GP) ZM2000X - (IS)

<b>Model number</b>	<b>Pressure range</b>
<b>Absolute Isolated (AI)</b>	
-AI0015	0 psi to 15 psi
-AI0030	0 psi to 30 psi
-AI0100	0 psi to 100 psi
-AI1000	0 psi to 1000 psi
<b>Compound Isolated (CI)</b>	
-CI0015	-14.5 psi to 15 psi
-CI0030	-14.5 psi to 30 psi
-CI0050	-14.5 psi to 50 psi
-CI0100	-14.5 psi to 100 psi
-CI0300	-14.5 psi to 300 psi
-CI0500	-14.5 psi to 500 psi
-CI1000	-14.5 psi to 1000 psi
-CI3000	-14.5 psi to 3000 psi
<b>Differential Isolated (DI)</b>	
-DI0001	-1 psi to 1 psi
-DI0005	-5 psi to 5 psi
-DI0015	-14.5 psi to 15 psi
-DI0030	-14.5 psi to 30 psi
-DI0050	-14.5 psi to 50 psi
-DI0100	-14.5 psi to 100 psi
-DI0300	-14.5 psi to 300 psi
-DI0500	-14.5 psi to 500 psi

## ***Internal sensors: type and range - continued***

Non-Isolated: ZM2000 - (GP) ZM2000X (IS)

<b>Model number</b>	<b>Pressure range</b>
<b>Absolute Non-Isolated (AN)</b>	
-AN0015	0 psi to 15 psi
-AN0030	0 psi to 30 psi
-AN0100	0 psi to 100 psi
<b>Compound Non-Isolated (CN)</b>	
-CN0001	-1 psi to 1 psi
-CN0005	-5 psi to 5 psi
-CN0015	-14.5 psi to 15 psi
-CN0030	-14.5 psi to 30 psi
-CN0050	-14.5 psi to 50 psi
-CN0100	-14.5 psi to 100 psi
<b>Differential Non-Isolated (DN)</b>	
-DN0001	-1 psi to 1 psi
-DN0005	-5 psi to 5 psi
-DN0015	-14.5 psi to 15 psi
-DN0030	-14.5 psi to 30 psi
-DN0050	-14.5 psi to 50 psi
-DN0100	-14.5 psi to 100 psi

## Meriam Tethered Sensors: type and range

ZMTS - (GP) ZMTSX - (IS)

<b>Model number</b>	<b>Pressure range</b>		
<b>Absolute Isolated (AI)</b>			
-AI0015	0 psi	to	15 psi
-AI0030	0 psi	to	30 psi
-AI0100	0 psi	to	100 psi
-AI1000	0 psi	to	1000 psi
<b>Compound Isolated (CI)</b>			
-CI0005	-14.5 psi	to	5 psi
-CI0015	-14.5 psi	to	15 psi
-CI0030	-14.5 psi	to	30 psi
-CI0050	-14.5 psi	to	50 psi
-CI0100	-14.5 psi	to	100 psi
-CI0300	-14.5 psi	to	300 psi
-CI0500	-14.5 psi	to	500 psi
-CI1000	-14.5 psi	to	1000 psi
-CI3000	-14.5 psi	to	3000 psi
-CI5000	-14.5 psi	to	5000 psi
<b>Differential Isolated (DI)</b>			
-DI0001	-1 psi	to	1 psi
-DI0005	-5 psi	to	5 psi
-DI0015	-14.5 psi	to	15 psi
-DI0030	-14.5 psi	to	30 psi
-DI0050	-14.5 psi	to	50 psi
-DI0100	-14.5 psi	to	100 psi
-DI0300	-14.5 psi	to	300 psi
-DI0500	-14.5 psi	to	500 psi
<b>Absolute Non-Isolated (AN)</b>			
-AN0015	0 psi	to	15 psi
-AN0030	0 psi	to	30 psi
-AN0100	0 psi	to	100 psi
<b>Compound Non-Isolated (CN)</b>			
-CN0001	-1 psi	to	1 psi
-CN0005	-5 psi	to	5 psi
-CN0015	-14.5 psi	to	15 psi
-CN0030	-14.5 psi	to	30 psi
-CN0050	-14.5 psi	to	50 psi
-CN0100	-14.5 psi	to	100 psi
<b>Differential Non-Isolated (DN)</b>			
-DN0001	-1 psi	to	1 psi
-DN0005	-5 psi	to	5 psi
-DN0015	-14.5 psi	to	15 psi
-DN0030	-14.5 psi	to	30 psi
-DN0050	-14.5 psi	to	50 psi
-DN0100	-14.5 psi	to	100 psi
<b>RTD Temperature sensor</b>			
-RTD	-50 °C	to	250 °C

## Pressure measurements

- Accuracy Specification
- $\pm$  (0.02% of FS + 0.005 % of Rdg) from 0% to 110% of FS.
- For Compound sensors only:
  - Vacuum:  $\pm$  (0.02 % of FS)
  - Vacuum = -14.5 psi
- Accuracy statements include the combined effects of linearity, repeatability, hysteresis, and temperature over the specified operating temperature range.
- Warm up time: 5 minutes.
- You should zero the sensor at working ambient temperature before using it.

## Resistance and temperature measurement capabilities

### Resistance measurement

- Range from 0  $\Omega$  to 400  $\Omega$ 
  - Alternate ranges available
- Typical Accuracy Specification
  - $\pm$  (0.015 % of reading + 0 .005 % of FS) total error band from -20  $^{\circ}$ C to 50  $^{\circ}$ C
  - Alternate specifications available

### Temperature sensor

- Pt100
  - Class A, 4-Wire Platinum RTD Elements per IEC 60751 Standard
  - 100  $\Omega$  at 0  $^{\circ}$ C, 0.00385 TCR (alpha)
  - Alternate sensor options available

### Temperature measurement

- Typical Accuracy Specification
  - $\pm$  0.3  $^{\circ}$ C total error band from -20  $^{\circ}$ C to 50  $^{\circ}$ C
  - End to end probe inclusive
  - Alternate specifications available

## ***Overrange limit***

- Overage pressure or temperature means the value is outside the calibrated upper or lower range.
- Above 100 %, the red backlight turns on automatically.
- Above 120 %, the red backlight turns on and displays OVER RANGE in place of pressure reading.

## ***Temperature***

- Storage: -20 °C to 70 °C (-4 °F to 158 °F)
- Operating: -10 °C to 50 °C (14 °F to 122 °F)

## ***Relative humidity***

- 95 % non-condensing

## ***Vibration***

- 1 meter drop test

## ***Ingress specifications***

- IP52 for the M2000
- IP54 for the MTS

## ***Altitude specifications***

### **NOTICE**

Do not use the M2000 Smart Manometer at an altitude above 2000 m (6561 ft.).

## ***Keypad***

- Sealed membrane 16 domes.



## ***Media compatibility***

### Pressure Types

- **DN:** Differential pressure, non-isolated sensors for use with clean, dry, non-corrosive gases only.
- **CN:** Compound non-isolated sensors for use with clean, dry, non-corrosive gases only.
- **AN:** Absolute non-isolated sensors for use with clean, dry, non-corrosive gases only.
- **DI:** Differential pressure, isolated sensors for use with gases and liquids compatible with 316LSS and Viton O-rings
- **CI:** Compound or Absolute pressure sensors for use with gases and liquids compatible with 316LSS.
- **AI:** Compound or Absolute pressure sensors for use with gases and liquids compatible with 316LSS.

### Pressure Limits



- **DN units:** 3x range or 200 psi, whichever is less.
- **CN units:** 3x range or 200 psi, whichever is less.
- **AN units:** 3x range or 200 psi, whichever is less.
- **DI units:** 1000 psi common mode, P1 (HI) only is 3x range, P2 (LO) only is 3x range or 150 PSI, whichever is less.
- **CI units:** 2x range.
- **AI units:** 2x range.

## ***Battery type***



- 4 AA alkaline batteries of the same battery type.
- For M2000X use only batteries listed on 9R698.

## Approvals

### M2000X Intrinsically Safe Model

<b>ATEX</b>	 II 1 G; Ex ia IIC T4 Ga DEMKO 19 ATEX 2196
<b>IECEX</b>	Ex ia IIC T4 Ga -10° C < Ta < +50° C IECEX UL 19.0026
<b>cULus Listed</b>	Intrinsically Safe  Class I, Div. 1 Groups A, B, C, D: T4 Exia Class I, Zone 0, AEx ia IIC T4 -10° C < Ta < +50° C
<b>Entity parameters:</b>	Po = 1.176W, Io = 227mA, Co = 19.99µF, Lo=0 µH, Uo = 5VDC Um=6VDC  CE Compliance

### MTSX Intrinsically Safe model

<b>ATEX</b>	 II 1 G; Ex ia IIC T4 Ga DEMKO 19 ATEX 2231
<b>IECEX</b>	Ex ia IIC T4 Ga -10° C < Ta < +50° C IECEX UL 19.0057
<b>cULus Listed</b>	Intrinsically Safe  Class I, Div. 1 Groups A, B, C, D: T4 Exia Class I, Zone 0, AEx ia IIC T4 Ga -10° C < Ta < +50° C
<b>Entity parameters:</b>	Pi = 1.25W, li = 227mA, Ci = 20 µF, Li=0 µH, Ui = 5VDC  CE Compliance

### M2000 and MTS (General Purpose models)

 CE Compliance Safety

## Hazardous locations use

### Intrinsically Safe Model

The M2000X and MTSX include certification for Intrinsically Safe operation.

Refer to the *Intrinsic Safety Control Drawing* [9R698](#) for **M2000X** and [9R699](#) for **MTSX** in the *Safety* section in this manual for more information.

### Hazardous locations and non-hazardous locations (safe locations)

The following table identifies model numbers and locations of acceptable use:

Model Number	Location	Non-hazardous location (Safe location)	Hazardous location
M2000	General Purpose	Yes	<b>NO</b>
M2000X	Intrinsically Safe	Yes	Yes
MTS	General Purpose	Yes	<b>NO</b>
MTSX	Intrinsically Safe	Yes	Yes



**NON-HAZARDOUS LOCATION**

MTS-VZZZ  
MTS-ZZZZ  
MTS-ZZZZ  
MTS-ZZZZ

MTS

(a)

(a2)

1.6

**HAZARDOUS LOCATION**

MTS-VZZZ  
MTS-ZZZZ  
MTS-ZZZZ  
MTS-ZZZZ

CL1 Div 1, Gr. A, B, C, D, E, G  
CL2, Div 2, Gr. A, B, C, D, E, G  
Ex II, III, C, T4, G

**NOTE:** Capacitance and Inductance of the field wiring from the intrinsically safe equipment to the associated apparatus shall be calculated and must be included in the system calculations. Cable capacitance and inductance shall be calculated and must be included in the system calculations. Cable capacitance C must be less than the marked capacitance Ca (or Co) shown on any associated apparatus used. The same applies for inductance (Lable L and La or Lo respectively). Where the cable capacitance and inductance per foot are not known the following values shall be used: Cable = 60pF/ft, Inductance = 0.24µH/ft.

**TABLE 1**

LT, Equipment	Associated Apparatus
V max (or U)	Voc or Vt (or Uo)
I max (or If)	Isc or It (or Io)
P max (or P)	Ps
Ci	Ca (or Co)
L	La (or Lo)

If Po of the associated apparatus is not known, it may be calculated using the formula  $Po = (Voc * Isc) / 4 = (Uo * Io) / 4$

1. Associated apparatus output current must be limited by a resistor such that the output voltage-current plot is a straight line drawn between open-circuit voltage and short-circuit current.

2. Selected associated apparatus must be third party listed as exceeding intrinsically safe circuits for the application, and have Voc or Vt not exceeding Vm as (or Uo) not exceeding U, Isc or It not exceeding Imax (or I not exceeding If), and Po of the associated apparatus must not exceed Ps. The output voltage-current plot of the intrinsically safe equipment, as shown in Table 1.

3. Associated apparatus must not be used in combination unless permitted by the associated apparatus certifications.

**ENTIRE PARAMETERS FOR MERIAM TETHER SENSOR**

U = 5VDC  
I = 227mA  
Vc = 1.25V  
C = 20µF  
L = 0µH

**ATTENTION** LA SUBSTITUTION DE COMPOSANTS PEUT COMPROMETTRE LA SECURITE INTRINSEQUE

**WARNINGS:**

1. SUBSTITUTION DE COMPOSANTS PEUT IMPAIR INTRINSEQUE

2. To prevent ignition of flammable or explosive atmospheres, Do Not repair or overhaul unit in flammable or explosive atmospheres.

**NOTE: FOR PRESSURE**  
MODEL NUMBER  
MTS-Meriam Tether Sensor  
X = Intrinsically safe  
YY-AL AN QI CN DI or DN  
ZZZZ = 0-9 or A-Z

**NOTE: FOR TEMPERATURE**  
MODEL NUMBER  
MTS-Meriam Tether Sensor  
X = In friskally safe  
ZZZZ = 0-9 or A-Z or Blank

**MTS-X Certi Location Label**

Model Number  
Serial Number  
Location

**CE**  
Warning: Intrinsically Safe Device  
Only when installed per 9R855

**MTS-X Certi Location Label**

NOT TO SCALE

**APPROVAL**

NAME	DATE	TYPE
DESIGNED BY		
CHECKED BY		
DATE		

**Meriam**  
Meriam Tether Sensor  
Meriam Control Systems  
TECHNICAL SUPPORT: 800-855-8899  
SERIAL: 9R899

**REVISIONS**

NO.	DESCRIPTION	DATE
1	ISSUED FOR PRODUCTION	02/27/18

## ***EMC compliance***



### **Conformity to EN 61326-1:2016**

This product has been evaluated to EN 61326-1:2016 the EMC General requirements for electrical equipment for measurement, control and laboratory use. This evaluation demonstrated that when the product is exposed to Radiated Radio Frequency energy in the frequency range 130-1000 MHz and 1.6-2.1 GHz, the pressure and temperature readings may fluctuate beyond the published tolerance of each respective value being measured. In the event of such a phenomenon occurring, the operator should move away from (or have removed) any source of strong RF emissions such as radio transmitters, cell-phones, etc., and repeat the measurement, or reconnect to a PC.

### **Electrostatic discharge (ESD)**

This unit is sensitive to ESD discharges that may result in the unit re-starting of the operating system, or interruption of a PC connection. In the unlikely event of such an occurrence, users should ensure they discharge any static charge they may be carrying by touching a known grounded conductive surface prior to operating the equipment .

## Dimensional specifications

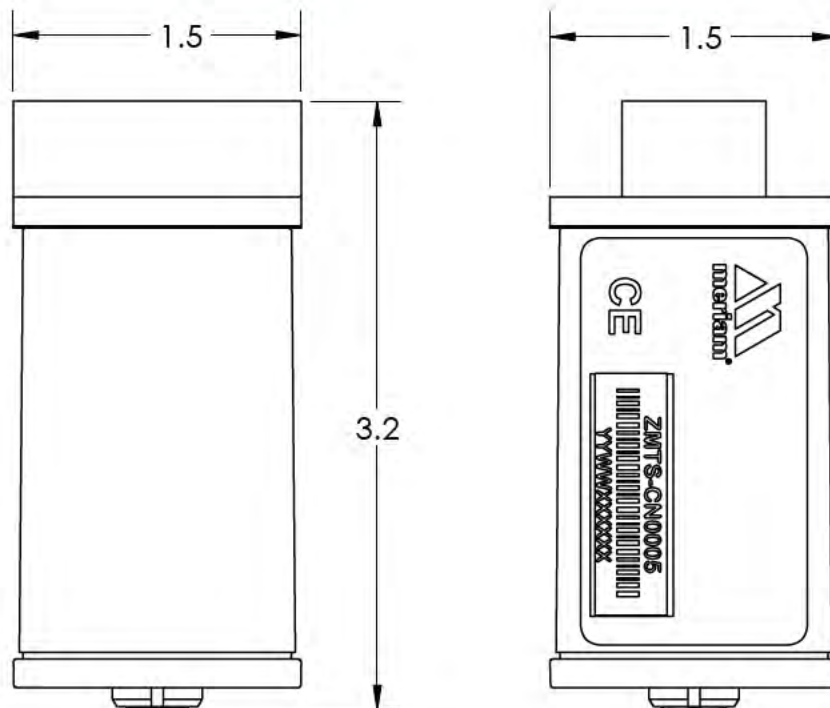

## ***Weight***

- Smart Manometer 1000 g (35.2 oz. or 2.2 lb.)
- MTS pressure module 148 g or 0.33 lb.
- MTS temperature module 92.5 g or 0.20 lb.

## ***Enclosure***

Polycarbonate / ABS alloy.





## EC Declaration of Conformity

### Manufacturer

### Product Description

MTS series pressure sensors

**This Declaration is based on compliance with the following standards at the time of original delivery:**

#### Regarding Ingress Protection

- EN60529 Degrees of Protection Provided by Enclosures (IP Code: IP52)

#### Regarding Electromagnetic Compatibility (EMC) for Handheld Class A device

M2000 Series compliant with EMC Directive 2014/30/EU

- EN 61326-1:2016 Electrical equipment for measurement, control and laboratory use-EMC requirements

The manufacturer also attests that the products listed above conform to the essential requirements of RoHS Directive 2011/65/EU and WEEE directive 2012/19/EU by self-declaration.

For and on behalf of  
Meriam Process Technologies,

A handwritten signature in black ink, appearing to read 'John Merrill', written over a horizontal line.

19-Dec-2019

John Merrill      Date:  
Standards Engineer  
Meriam Process Technologies



## EC Declaration of Conformity

This is to declare, in accordance with Directive 2014/34/EU, that the following product(s) are designed and manufactured in accordance with Annex II of 2014/34/EU.

The manufacturer attests on their own responsibility that the apparatus has been constructed in accordance with the principles of good engineering in safety matters, and that any routine verification and test required by Clause 27 of EN 60079-0:2018 has been successfully completed.

### Manufacturer

### Product Description

M2000X Series Smart Manometer

 0539  II 1 G  
 DEMKO 19 ATEX 2196  
 Ex ia IIC T4 Ga

### Entity parameters:

$P_o = 1.176 \text{ W}$     $I_o = 227 \text{ mA}$   
 $C_o = 19.99 \mu\text{F}$     $L_o = 0 \mu\text{H}$   
 $U_o = 5 \text{ VDC}$

**This Declaration is based on compliance with the following standards at the time of original delivery:**

### Regarding Hazardous Environments

- EN 60079-11:2012    Electrical apparatus for explosive gas atmospheres - Intrinsic safety 'i'
- EN 60079-0:2018    Electrical apparatus for explosive gas atmospheres - General requirements

### Regarding Ingress Protection

- EN60529    Degrees of Protection Provided by Enclosures (IP Code: IP52)

### Regarding Electromagnetic Compatibility (EMC) for Handheld Class A device

M2000X Series compliant with EMC Directive 2014/30/EU

- EN 61326-1:2016    Electrical equipment for measurement, control and laboratory use-EMC requirements

The manufacturer also attests that the products listed above conform to the essential requirements of RoHS Directive 2011/65/EU and WEEE directive 2012/19/EU by self-declaration.

For and on behalf of  
Meriam Process Technologies,



19-Dec-2019

John Merrill                      Date:  
Standards Engineer  
Meriam Process Technologies



## EC Declaration of Conformity

### Manufacturer

### Product Description

MTS series pressure sensors

**This Declaration is based on compliance with the following standards at the time of original delivery:**

#### Regarding Ingress Protection

- EN60529 Degrees of Protection Provided by Enclosures (IP Code: IP52)

#### Regarding Electromagnetic Compatibility (EMC) for Handheld Class A device

MTS Series compliant with EMC Directive 2014/30/EU

- EN 61326-1:2016 Electrical equipment for measurement, control and laboratory use-EMC requirements

The manufacturer also attests that the products listed above conform to the essential requirements of RoHS Directive 2011/65/EU and WEEE directive 2012/19/EU by self-declaration.

For and on behalf of  
Meriam Process Technologies,

A handwritten signature in black ink, appearing to read 'John Merrill', written over a horizontal line.

19-Dec-2019

John Merrill                      Date:  
Standards Engineer  
Meriam Process Technologies



## EC Declaration of Conformity

This is to declare, in accordance with Directive 2014/34/EU, that the following product(s) are designed and manufactured in accordance with Annex II of 2014/34/EU.

The manufacturer attests on their own responsibility that the apparatus has been constructed in accordance with the principles of good engineering in safety matters, and that any routine verification and test required by Clause 27 of EN 60079-0:2018 has been successfully completed.

### Manufacturer

### Product Description

MTSX Sensor Series

 0539  II 1 G  
 DEMKO 19 ATEX 2231  
 Ex ia IIC T4 Ga

### Entity parameters:

$P_o = 1.25 \text{ W}$      $I_o = 227 \text{ mA}$   
 $C_o = 20 \mu\text{F}$      $L_o = 0 \mu\text{H}$   
 $U_o = 5 \text{ VDC}$

**This Declaration is based on compliance with the following standards at the time of original delivery:**

### Regarding Hazardous Environments

- EN 60079-11:2012    Electrical apparatus for explosive gas atmospheres - Intrinsic safety 'i'
- EN 60079-0:2018    Electrical apparatus for explosive gas atmospheres - General requirements

### Regarding Ingress Protection

- EN60529    Degrees of Protection Provided by Enclosures (IP Code: IP54)

### Regarding Electromagnetic Compatibility (EMC) for Handheld Class A device

MTSX Series compliant with EMC Directive 2014/30/EU

- EN 61326-1:2016    Electrical equipment for measurement, control and laboratory use-EMC requirements

The manufacturer also attests that the products listed above conform to the essential requirements of RoHS Directive 2011/65/EU and WEEE directive 2012/19/EU by self-declaration.

For and on behalf of  
Meriam Process Technologies,



19-Dec-2019

John Merrill                      Date:  
Standards Engineer  
Meriam Process Technologies

# Maintenance and cleaning

## *Cleaning*

- Clean the MTS and its cable with a soft, damp cloth.
- Clean the Luer Locks with a soft, damp cloth or replace them as needed.

## *Prepare the Smart Manometer for storage*

### Remove the batteries to store the Smart Manometer

- We recommend that you remove the batteries from the Smart Manometer if you are storing it for an extended time period.
- Follow the battery manufacturer's instructions for storing your batteries.

### Store the Smart Manometer

- The recommended storage temperature for the Smart Manometer is between:  $-20\text{ }^{\circ}\text{C}$  to  $70\text{ }^{\circ}\text{C}$  ( $-4\text{ }^{\circ}\text{F}$  to  $158\text{ }^{\circ}\text{F}$ )